

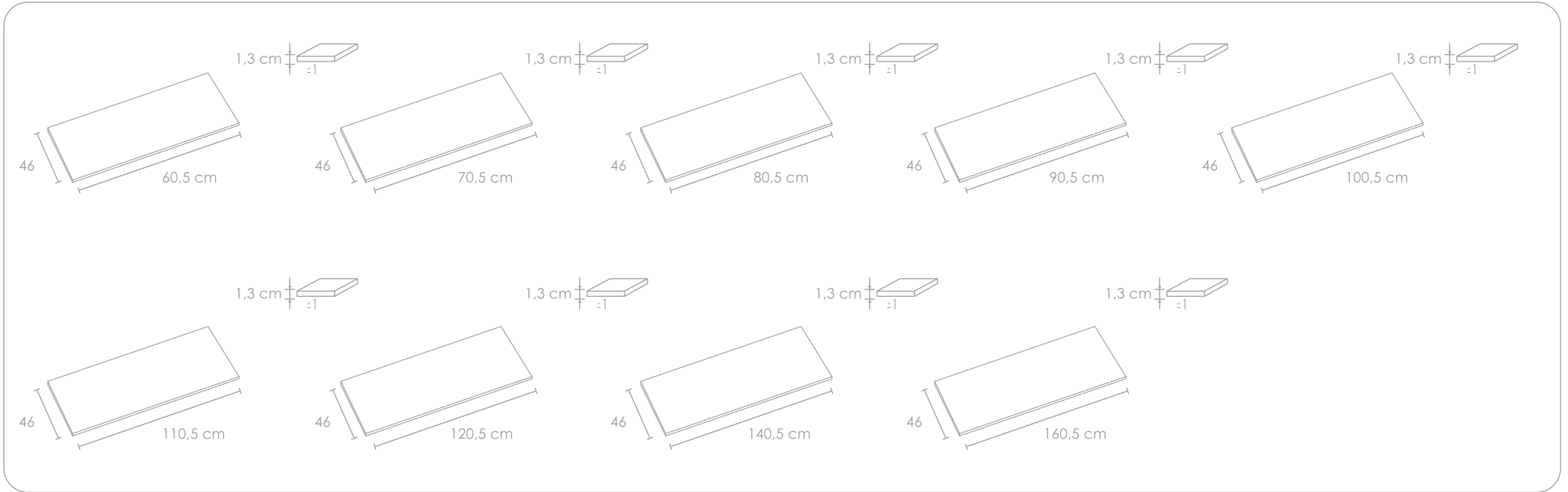











Camargue



Características

-  Textura natural
-  Resistencia a productos químicos
-  Normativas CEE
-  Tacto suave
-  Resistencia a hidrólisis
-  Fácil limpieza
-  Anti bacteriano
-  Resistencia a rayos UV
-  Tratamiento anti cal
-  Pigmentación en masa
-  Gran resistencia al rayado
-  Grosos de 1,3 cm

Tapas /

ENCIMERAS

Color

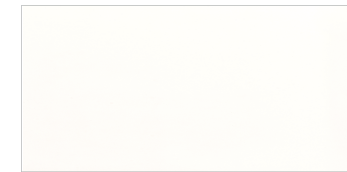

Blanco Solid surface

Textura

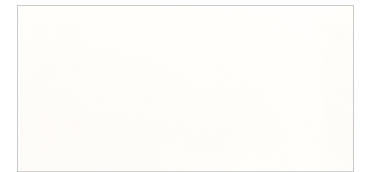

Lisa