







FICHA TÉCNICA

Colgante Bunny Rosa 30ø

REFERENCIA CLIENTE:	28695587	REFERENCIA IDP	14321
---------------------	----------	----------------	-------

DESCRIPCIÓN DEL PRODUCTO

Pantalla colgante infantil conejos

Color:	Rosa
Material:	Textil + PVC
Tipo de Casquillo:	E27
Potencia Máxima:	40W
Grado de protección IP:	IP20
Clasificación contra choque eléctrico:	Clase 2
Embalaje (cm):	32x32x24
Peso neto(kg) / Peso bruto(kg):	0.695 / 1.145
Pictogramas:	     



ÍNDICE

-DC: Declaración de Conformidad.

-RoHS: Declaración RoHS.

-REACH: Declaración REACH.

-BOM: Lista de materiales.

-Etiquetado.

-Manual de instrucciones.



FICHA TÉCNICA



EU-DECLARATION OF CONFORMITY DÉCLARATION DE CONFORMITÉ « UE »



SUPPLIER'S NAME: IDP Lampshades, S.A

ADDRESS: Pol. Ind. " El Oliveral " Parcela 23, 46190 (Riba-Roja, Valencia, España)

Phone(and EMAIL:: 34-961668611 idp@idplamp.com

We declare on one's own authority that our luminaire:

Nous déclarons sous notre propre autorité que nos luminaires:

Pendant luminaire	E27	Class II	IP20	40	W max
Product Name:	Customer Reference:		IDP Reference:		
COLG Nestor Rosa Pastel 30Ø	28713966		14322		

Comply with the essential requirements of the European Directives:

Respecte les exigences essentielles des Directives Européenne:

- 2014/35/EU (Low Voltage Directive)
- 2015/863/EU (RoHS Directive)

Complies with Regulation (EC) No. REACH 1907/2006

Est conforme au règlement (CE) REACH N°1907/2006

This is possible by application of the following harmonized standards based on the construction:

Ceci est possible par l'application des normes harmonisées suivantes basées sur la construction:

EN 60598-1:2015+ A1:2018

EN 60598-2-1:1993 Particular requirements, fixed general purpose luminaires

Certified by the test report of: AIDIMME

Certifié par le rapport d'essai établi par: AIDIMME

N°: 21803194 date of update: 14/09/2021

Year in which the CE marking was affixed: 2018

Année d'apposition du marquage CE : 2018

Made in Riba-Roja (Valencia, España),

21/09/2021

Quality Manager: Óscar Barceló García



CIF: E58A-65298564
Pol. Ind. " El Oliveral " Parcela 23, 46190 RIBA-ROJA (Valencia)
Tel.: +34 96 166 86 11
E-mail: idp@idplamp.com
www.idplamp.com



FICHA TÉCNICA



Certificate of compliance with European Regulation 1907/2006 (REACH)

Certificat de conformité au Règlement Européen 1907/2006 (REACH)

SUPPLIER'S NAME: IDP Lampshades, S.A

ADDRESS: Pol. Ind. " El Oliveral" Parcela 23, 46190 (Riba-Roja, Valencia, España)

Phone(and EMAIL:: 34-961668611 idp@idplamp.com

We are aware of the legislation of the EU and restrictions on certain chemicals in the REACH Regulation (Registration, Evaluation, Authorisation and Restriction of Chemicals program).

Nous sommes conscients de la législation de l'UE et des restrictions sur certains éléments chimiques dans le cadre du règlement REACH (enregistrement, évaluation, autorisation et Restriction du programme des produits chimiques).

We are supplier of products which are products that do not release "intentionally" chemicals, and therefore we are not bound by the REACH regulation on chemical registration.

Nous sommes fournisseur d'articles qui sont des produits qui ne libèrent pas « intentionnellement » de produits chimiques, et donc nous ne sommes pas liés par le règlement REACH concernant l'inscription de produit chimique.

REACH requires that participants in the supply chain, to communicate the presence of very high concern (SVHC) by more than 0.1% by weight in their products. SVHC are identified on the candidate list by the European Chemicals Agency (ECHA). New SVHCs are added to the list of candidates at least twice a year. The final candidate list SVHC can be found at the following address:

REACH exige que les participants de la chaîne d'approvisionnement, communiquent la présence des substances extrêmement préoccupantes (SVHC) de plus de 0,1% en poids dans leurs produits. Les SVHC sont identifiés sur la Liste candidate par l'Agence européenne des produits chimiques (ECHA). De nouveaux SVHC sont ajoutés à la liste candidate au moins deux fois par an. La dernière liste candidate de SVHC peut être trouvé à l'adresse suivante:

<http://echa.europa.eu/candidate-list-table>

<http://echa.europa.eu/fr/candidate-list-table>

We declare that our products listed below do not contain any of these substances in concentrations higher than 0.1% by weight per item. We will notify our customers immediately if a SVHC is found in our product is above the 0.1% level.

Nous déclarons que nos produits cités ci-dessous ne contiennent aucune de ces substances dans des concentrations supérieures à 0,1% en poids par article. Nous aviserons immédiatement nos clients si une substance SVHC est découverte dans nos produits est au-dessus du niveau de 0,1%.

Product Name:	Customer Reference:	IDP Reference:
COLG Nestor Rosa Pastel 30Ø	28713966	14322

Made in Riba-Roja (Valencia, España),
Quality Manager: Óscar Barceló García

14/09/2021



CIF: E51A-66298664
Pol. Ind. "El Oliveral" Parcela 23, 46190 RIBA-ROJA (Valencia)
Tel: +34 961668611
E-mail: idp@idplamp.com
www.idplamp.com



FICHA TÉCNICA



RoHS Certificate of Compliance DÉCLARATION DE CONFORMITÉ RoHS

SUPPLIER'S NAME: IDP Lampshades, S.A

ADDRESS: Pol. Ind. " El Oliveral" Parcela 23, 46190 (Riba-Roja, Valencia, España)

Phone(and EMAIL:: 34-961668611 idp@idplamp.com

Class III

We certify that all our products, without exemption, comply with the requirements of RoHS Directive 2015/863 of 31st March 2015 amending Annex II to Directive 2011/65/EU and 2017/2102 /EU restricting the use of hazardous substances in electrical and electronic equipment.

We certify that prohibited substances described below, are not added during the manufacturing process and finished products are of the lower concentrations at acceptable limits of RoHS.

-Lead (Pb)	< 0.1 % by weight (1000 ppm)
-Mercury (Hg)	< 0.1 % by weight (1000 ppm)
-Cadmium (Cd)	<0.01 % by weight (100 ppm)
-Hexavalent chromium (Cr(VI))	< 0.1 % by weight (1000 ppm)
-Polybrominated biphenyls (PBB)	< 0.1 % by weight (1000 ppm)
-Polybrominated diphenyl ethers (PBDE)	< 0.1 % by weight (1000 ppm)
-Bis(2-Ethylhexil) phthalate (DEHP)	< 0.1 % by weight (1000 ppm)
-Benzyl butyl phthalate (BBP)	< 0.1 % by weight (1000 ppm)
-Dibutyl phthalate (DBP)	< 0.1 % by weight (1000 ppm)
-Di-isobutyl phthalate (DIBP)	< 0.1 % by weight (1000 ppm)

The following product is compliant with RoHS requirement:

Product Name:	Customer Reference:	IDP Reference:
COLG Nestor Rosa Pastel 30ø	28713966	14322

Made in Riba-Roja (Valencia, España),
Quality Manager: Óscar Barceló García

14/09/2021



CIF: E61A-66290664
Pol. Ind. "El Oliveral" Parcela 23, 46190 RIBA-ROJA (Valencia)
Tel: +34 96 166 86 11
E-mail: idp@idplamp.com
www.idplamp.com

BOM: Lista de materiales

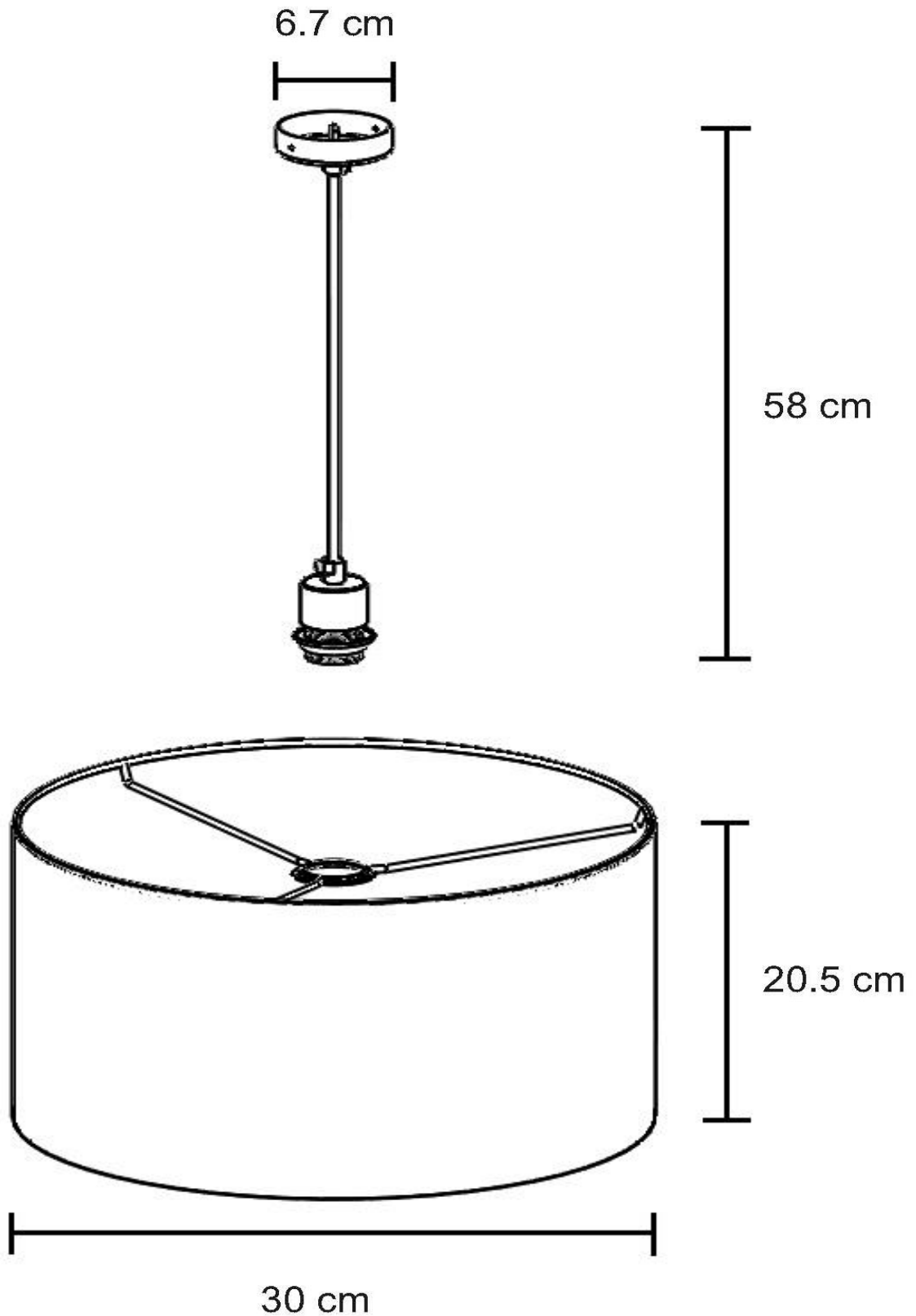



FICHA TÉCNICA

ETIQUETADO

S/REFER. : 28695587
DESCRIPCION: CG TUBO DIB.BUNNY ROSA PASTEL
MEDIDAS : 30 - 30 - 20,5
MATERIAL : ALGODONTESMO
COLOR : CRUDO 121 - 624 - 800

 (Max. 40 W.)
8 425975 143217 /2791 \varnothing 30



Idp Lampshades S.A. Ref.: 520
230V ~ 50Hz Max. 40W E-27
Made in E.U.     

MANUAL DE INSTRUCCIONES

INSTALLAZIONE / IMPORTANTE

Questa sospensione, realizzata in classe II, (Simbolo ) non deve essere collegata a terra. Per una corretta installazione, dopo aver connesso alla morsettiera il cavo proveniente dal plafone, spingere il rosone contro il plafone e bloccarlo avvitando la vite del rosone.

INSTALLATION / IMPORTANT

This luminaire, realized in class II, (symbol ) has not to be provided for earthing. For a correct installation, after have connected the wire coming from the ceiling to the block terminal, push the ceiling rose against the ceiling and then block it screwing the screw.

INSTALLATION / IMPORTANT

De luminaire, de classe II, (symbole ) ne doit pas être relié à la terre. Pour conserver à ce produit toute sa sécurité, la longueur des conducteurs d'alimentation venant du plafond devra impérativement être limitée à 60cm, de manière à ce qu'ils soient entièrement gainés par le manchon souple incorporé au boîtier de raccordement (à la son plus court, raccourcir le manchon).

INSTALAÇÃO / IMPORTANTE

Este luminária, de classe II, (símbolo ) não deve ser conectada à terra. Para uma correcta instalação, o comprimento dos condutores de alimentação provenientes do tecto, não deverá ser superior a 60 centímetros, por forma a permitir que a manga de protecção flexível incorporada ao bloco de terminais revista completamente os condutores (Cortar a manga se os condutores são mais curtos).

INSTALACIÓN / IMPORTANTE

Esta suspensión, realizada en clase II, (Símbolo ) no debe estar conectada a tierra. Para una correcta instalación, la longitud del cable proveniente del plafón no debe ser superior a 60cm de modo que está enteramente cubierto por la tapa de la regleta. (Acortar el tubo aislante si el cable es demasiado corto).

PLAATSING / BELANGRIJK

Deze verlichting van Klasse II (symbool ) moet niet verboden worden aan de aarding. Voor een juiste aansluiting mag de kabel komende vanuit het plafond niet langer zijn dan 60cm. De kabel moet helemaal omsloten worden door de soepele kiem (indien de draad korter is de kiem inkorten).

