

Abbildung für Türbreite 985 mm.
 Bei schmaleren Türbreiten muss
 die Schiene gekürzt und neu gebohrt werden.

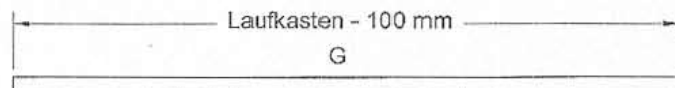

1700064

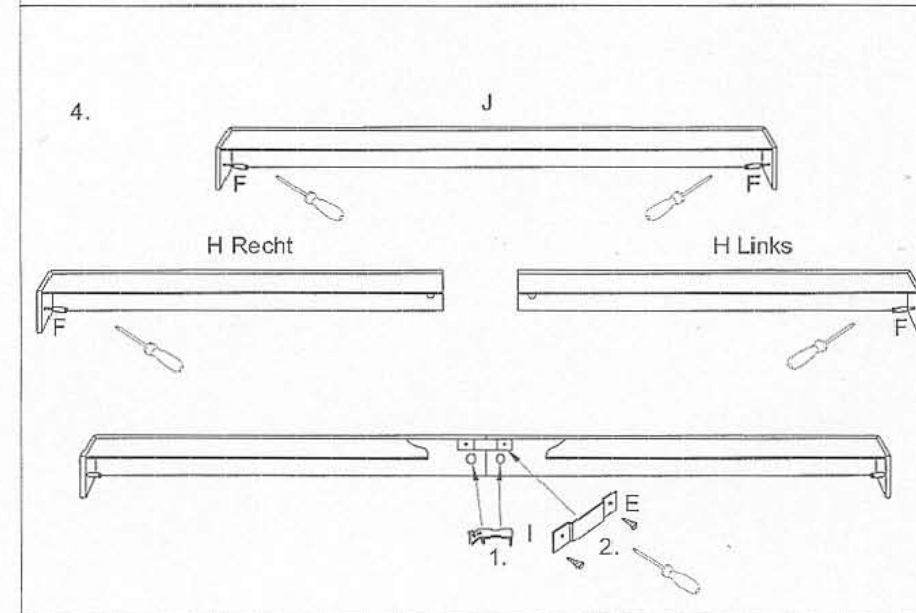

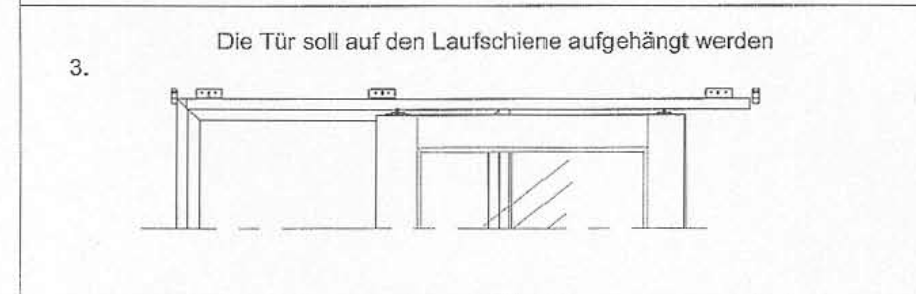
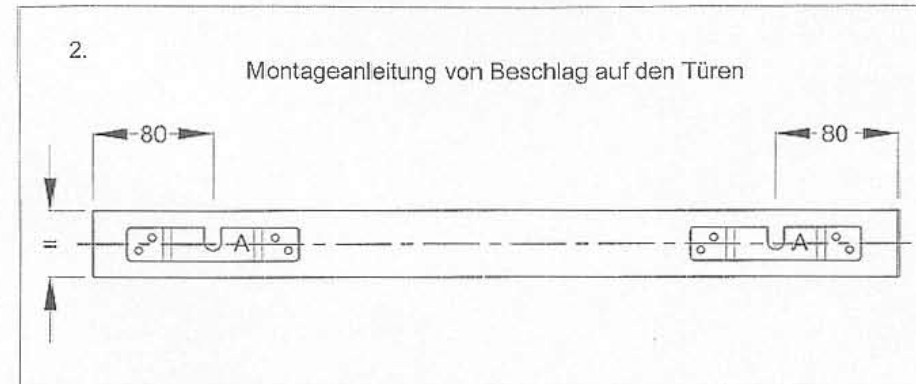
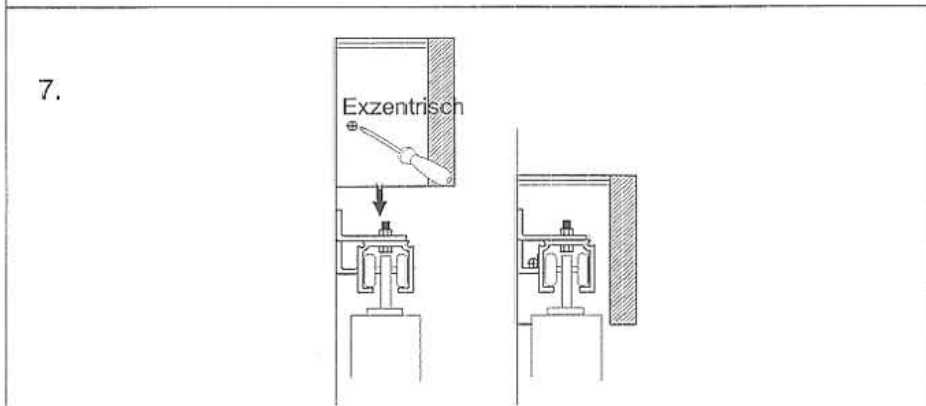
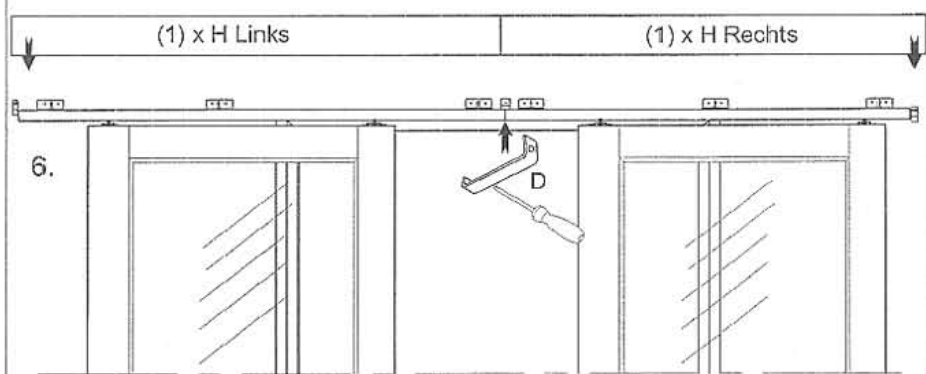
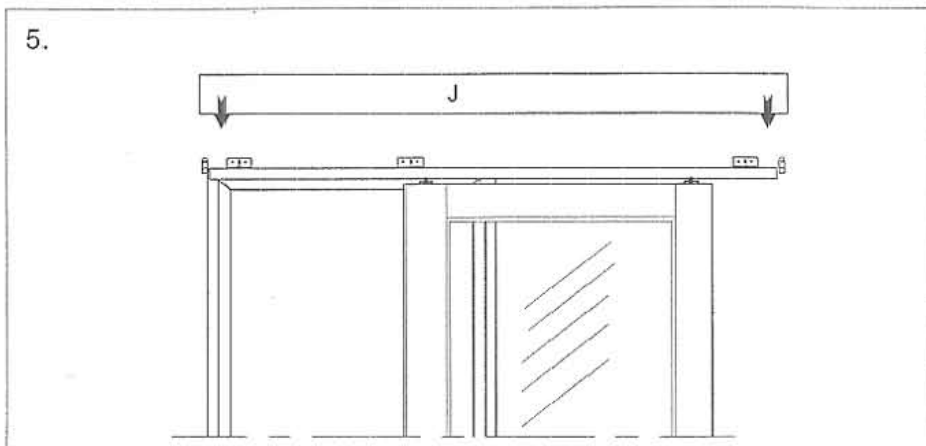

1700064

Montageanleitung für Schiebetür vor der Wand laufend

Vor der Montage ist eine Durchgangszarge zu montieren

