

KIT SIMONCLOTHING MOBILE SINGLE 3

300 x 90 x 50 cm

(118.1" x 35.4" x 19.7")

5 years
SIMONRACK
GUARANTEE

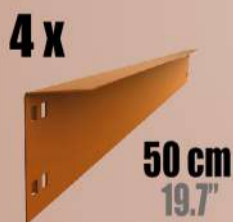
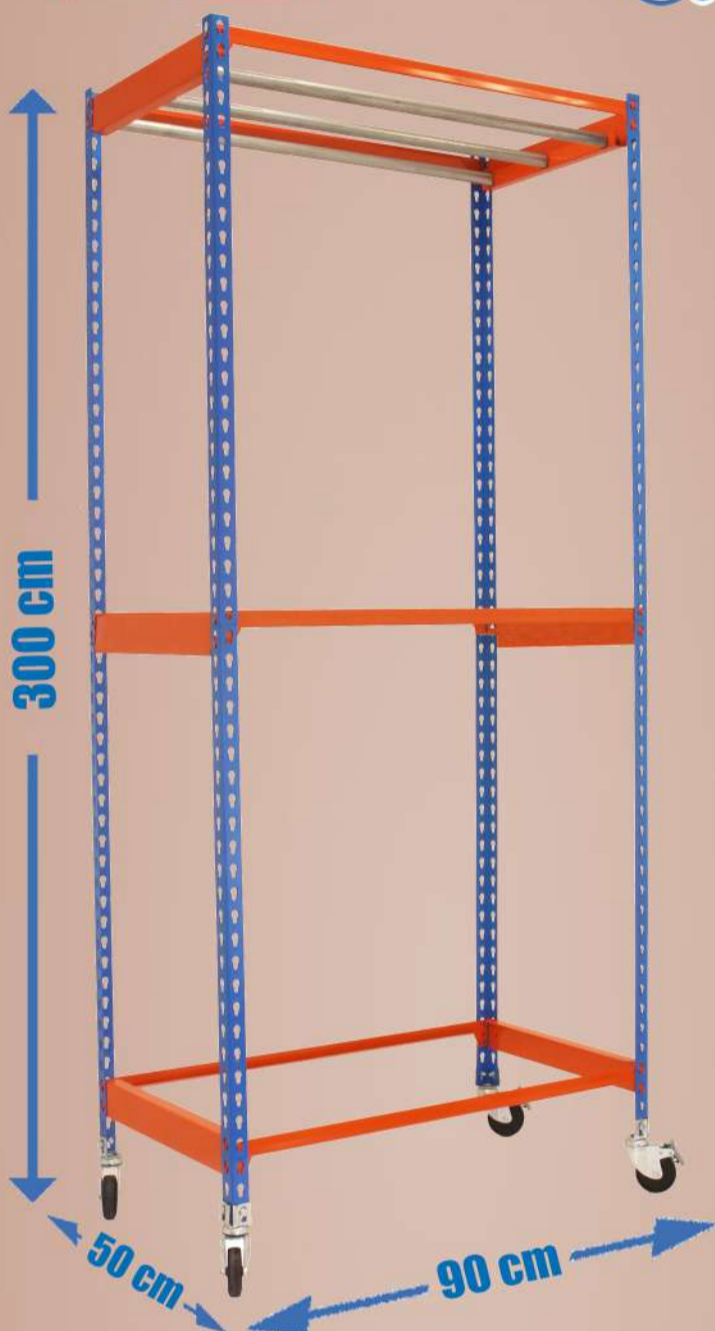

INSTRUCCIONES
INSTRUCTIONS
ANLEITUNG
INSTRUCTIONS

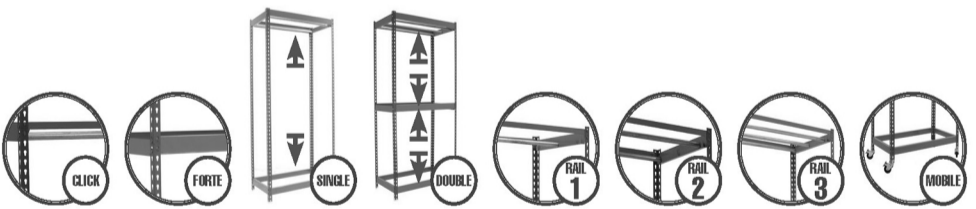
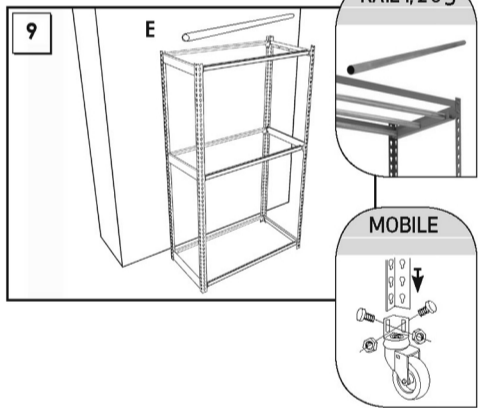
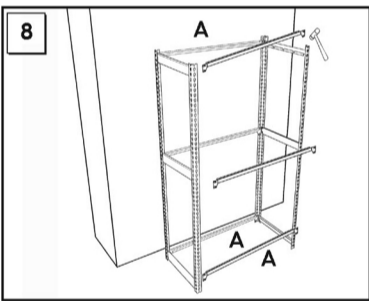
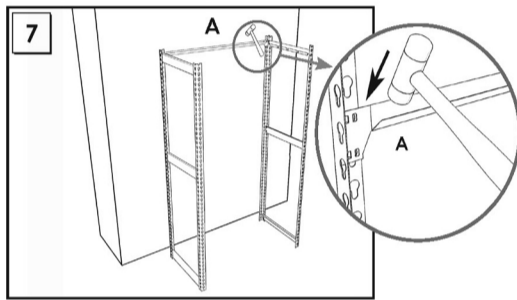
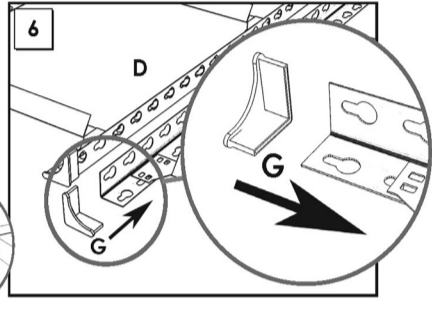
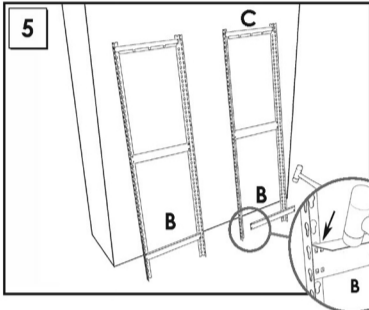
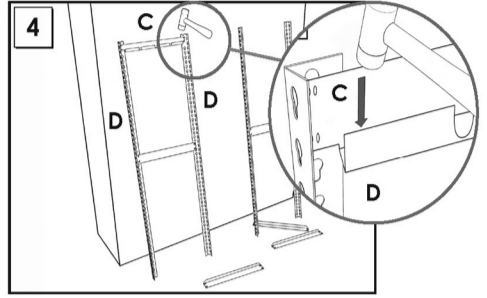
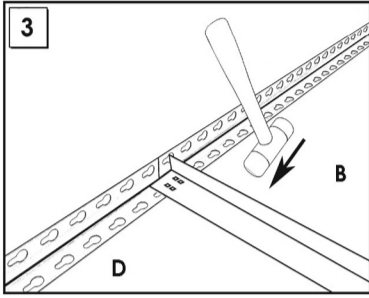
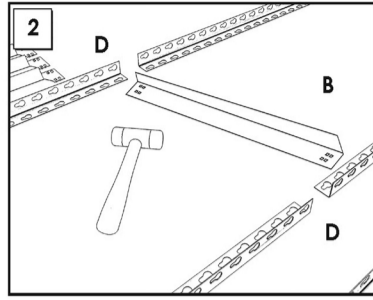
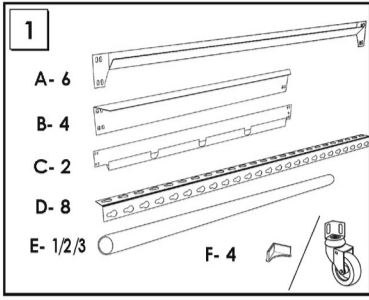

www.simonrack.com • www.simonrack.com • www.simonrack.com • www.simonrack.com

<p>SIMONCLASSIC</p> <p>150 kg 350 lb</p>	<p>SIMONCLICK</p> <p>400 kg 900 lb</p>	<p>SIMONTALLER</p> <p>700 kg 1550 lb</p>	<p>SIMONAUTO</p> <p>300 kg 660 lb</p>
<p>SIMONWORK</p> <p>800 kg 1800 lb</p>	<p>SIMONLOCKER</p>	<p>SIMONOFFICE</p> <p>275 kg 600 lb</p>	<p>SIMONHOME</p> <p>150 kg 330 lb</p>
<p>SIMONGARDEN</p> <p>600 kg 1350 lb</p>	<p>SIMONTITÁN</p> <p>900 kg 1990 lb</p>	<p>SIMONINOX</p>	<p>SIMONINDUSTRIAL</p> <p>SIMONPALET 4500 kg 9950 lb</p> <p>SIMONLEVER</p> <p>ALTILLOS Y PASILLOS ELEVADORES • PLATAFORMAS Y MEZZANINES • LAGERFÖRHINEN • PLATES FORMES ET MEZZANINES</p>