

Additional Shelf

240 x 60 cm*
94.5" x 23.6"

**KIT
2/2**

5 Años Garantía
Years Guarantee
Jahre Garantie
Ans Garantie
Anos de Garantía
SIMONRACK

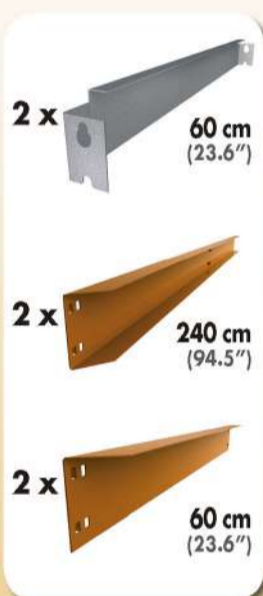

On-line instructions: www.instructionsrack.com/simonfortechipboard



www.simonrack.com



INSTRUCCIONES
INSTRUCTIONS
ANLEITUNG
INSTRUCTIONS

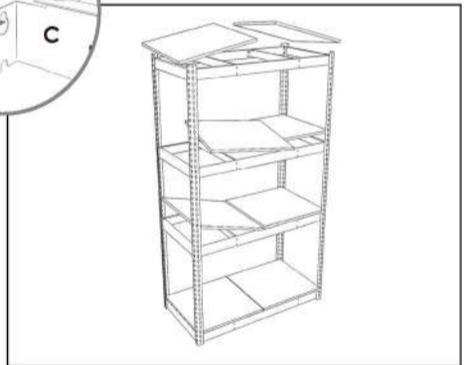
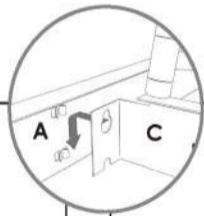
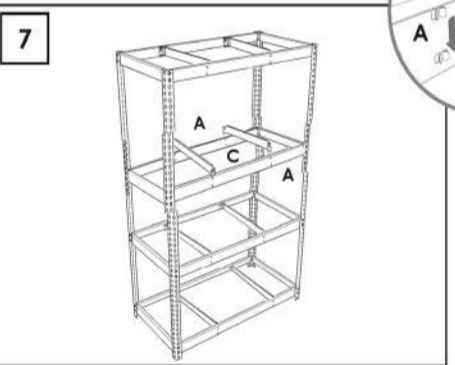
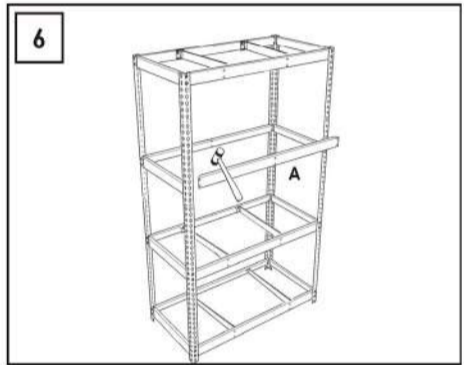
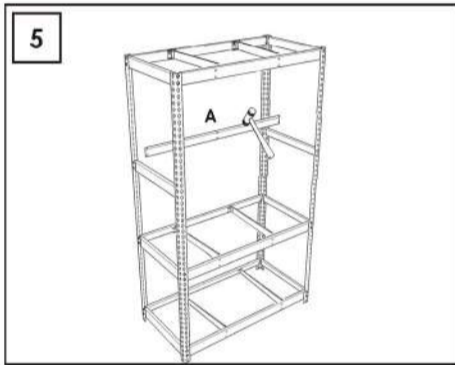
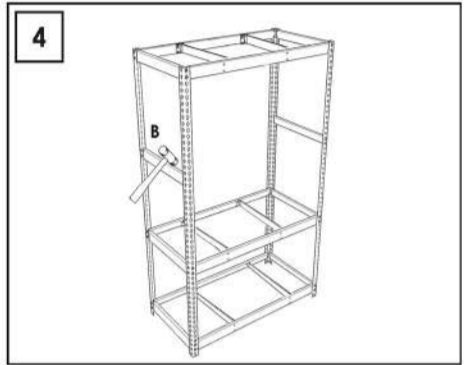
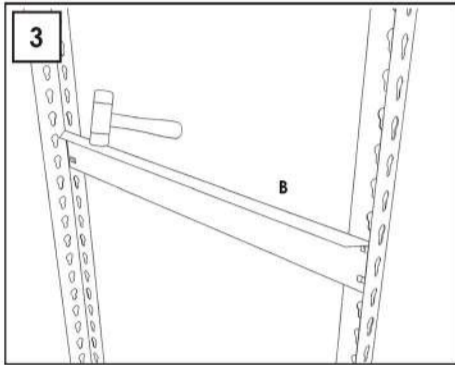
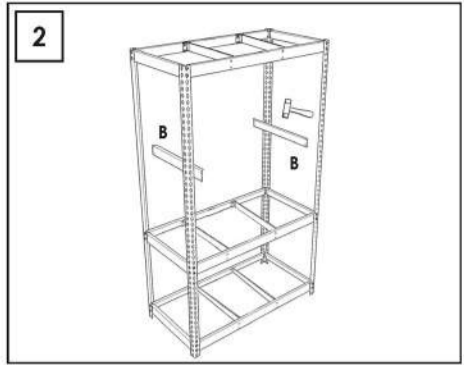
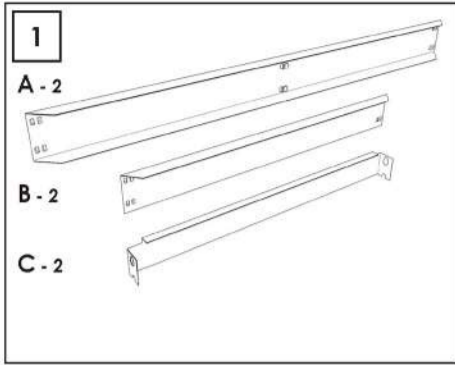

www.instructionsrack.com/simonfortechipboard

www.simonrack.com • www.simonrack.com • www.simonrack.com • www.simonrack.com

SIMONCLASSIC



SIMONCLICK



SIMONTALLER



SIMONAUTO



SIMONWORK



SIMONLOCKER



SIMONOFFICE



SIMONHOME



SIMONGARDEN



SIMONTITÁN



SIMONINOX



SIMONINDUSTRIAL

