

240 x 45 cm
94.5" x 17.7"

5 Años Garantía
Years Guarantee
Jahre Garantie
Anos de Garantia
SIMONRACK

KIT
2/2

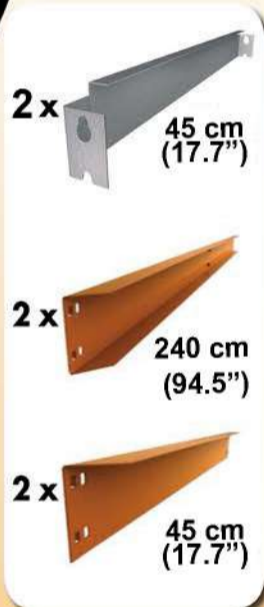
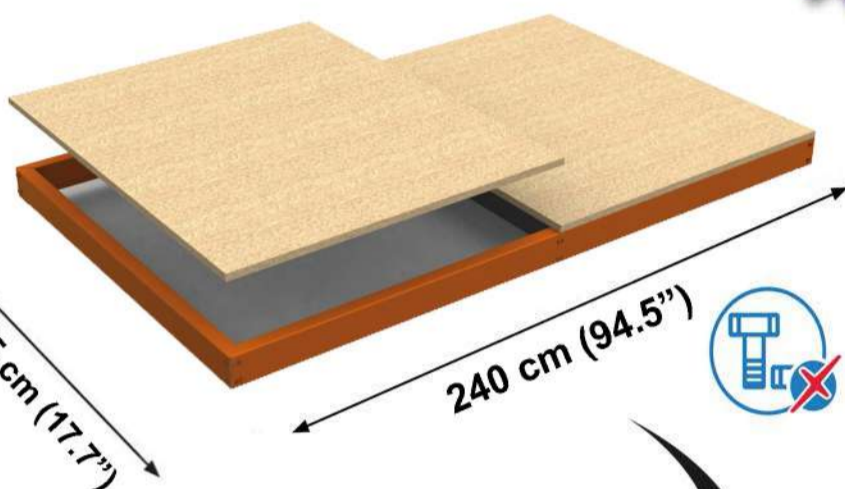

On-line instructions: www.instructionsrack.com/simontaller



www.simonrack.com



INSTRUCTIONS

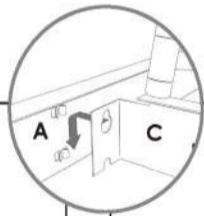
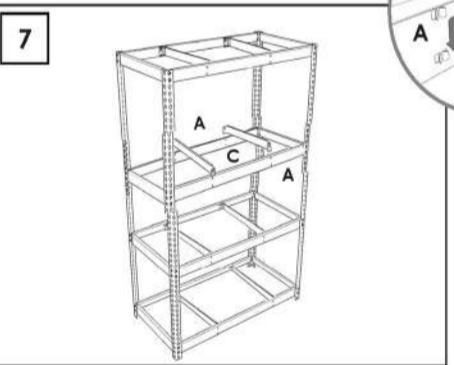
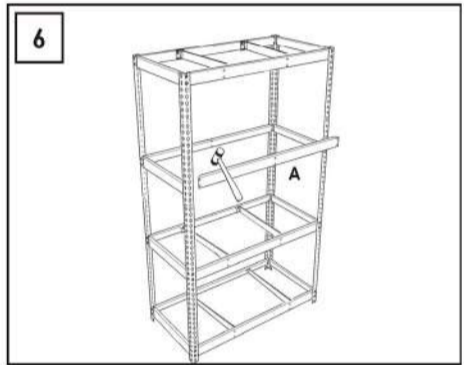
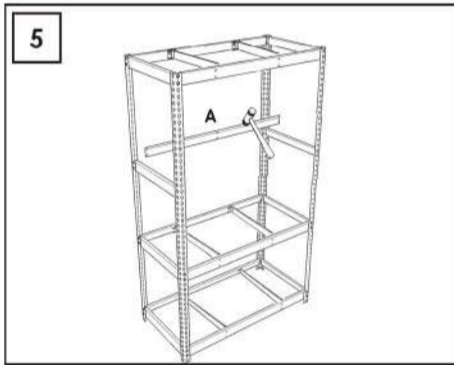
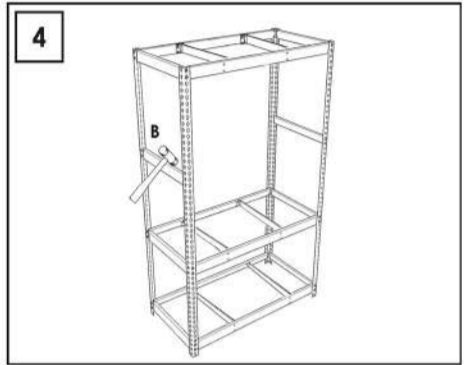
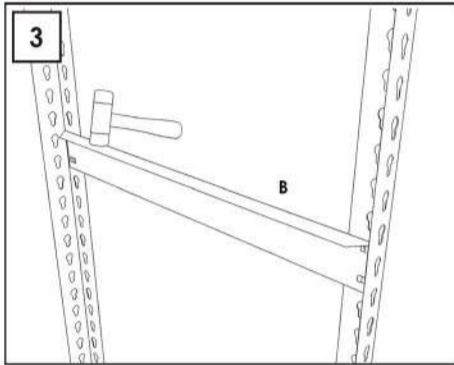
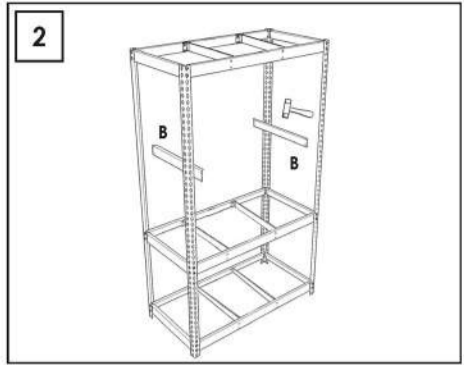
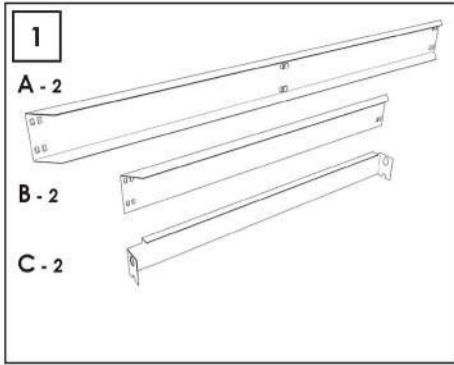

www.instructionsrack.com/simonfortechipboard

www.simonrack.com • www.simonrack.com • www.simonrack.com • www.simonrack.com

SIMONCLASSIC



SIMONCLICK



SIMONTALLER



SIMONAUTO



SIMONWORK



SIMONLOCKER



SIMONOFFICE



SIMONHOME



SIMONGARDEN



SIMONTITÁN



SIMONINOX



SIMONINDUSTRIAL

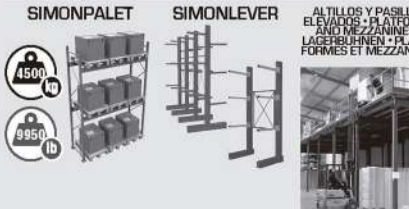

ALTILLOS Y PASILLOS
ELEVADOS • PLATAFORMAS
AND MEZZANINES •
LAGERBÜHNEN • PLATES
FORMES ET MEZZANINES