

# 100 x 80 x 30 cm

## 39.3" x 31.5" x 11.8"

### KIT SIMONBOTTLE SHELF 1-2



**5** Años Garantía  
Years Guarantee  
Jahre Garantie  
Ans Garantie  
Anos de Garantia

**SIMONRACK**

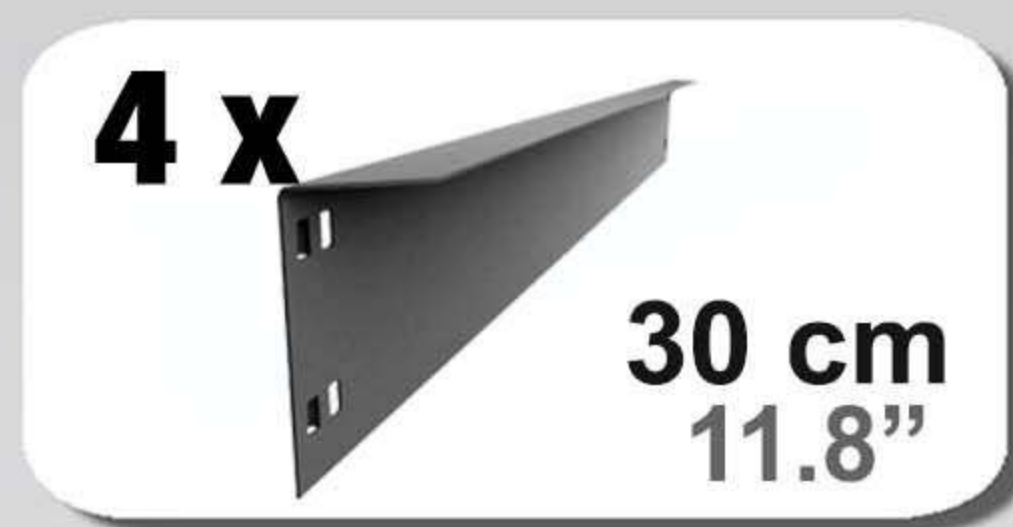

\*MEDIDAS EN USO • USED MEASUREMENTS  
MASSNAHMEN IM EINSATZ • MESURES EN EMPLOI • MEDIDAS EM USO:  
1010 x 810 x 310 mm ( 39.7" x 31.9" x 12.2")



**Simon Rack**  
SINCE 1964 - MANUFACTURER







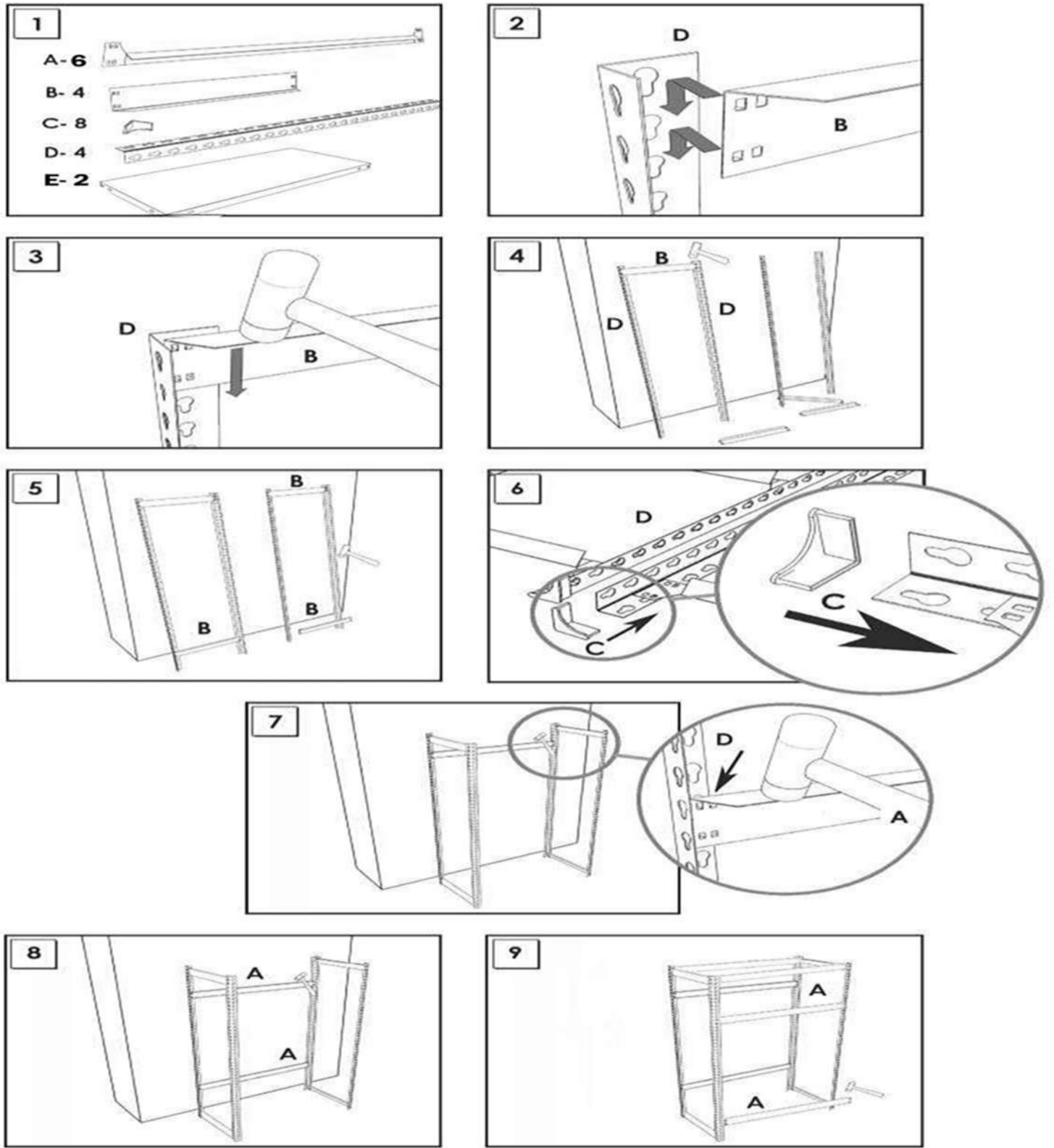





ESTANTERIAS SIMON S.L. B.50.556.463  
PG. ALFAMEN C/ POLIGONO C, N°3  
ALFAMEN (ZARAGOZA)



INSTRUCCIONES  
INSTRUCTIONS  
ANLEITUNGS  
INSTRUCTIONS



www.simonrack.com • www.simonrack.com • www.simonrack.com • www.simonrack.com

SIMONCLASSIC	SIMONCLICK	SIMONTALLER	SIMONAUTO
 <ul style="list-style-type: none"> <li>150 kg</li> <li>350 lb</li> </ul>	 <ul style="list-style-type: none"> <li>400 kg</li> <li>900 lb</li> </ul>	 <ul style="list-style-type: none"> <li>700 kg</li> <li>1550 lb</li> </ul>	 <ul style="list-style-type: none"> <li>300 kg</li> <li>660 lb</li> </ul>
SIMONWORK	SIMONLOCKER	SIMONOFFICE	SIMONHOME
 <ul style="list-style-type: none"> <li>800 kg</li> <li>1800 lb</li> </ul>		 <ul style="list-style-type: none"> <li>275 kg</li> <li>600 lb</li> </ul>	 <ul style="list-style-type: none"> <li>150 kg</li> <li>350 lb</li> </ul>
SIMONGARDEN	SIMONTITÁN	SIMONINOX	SIMONINDUSTRIAL
 <ul style="list-style-type: none"> <li>600 kg</li> <li>1350 lb</li> </ul>	 <ul style="list-style-type: none"> <li>900 kg</li> <li>1900 lb</li> </ul>		<div style="display: flex;"> <div style="flex: 1;">  <ul style="list-style-type: none"> <li>4500 kg</li> <li>9950 lb</li> </ul> </div> <div style="flex: 1;">  </div> </div> <p>ALTILOS Y PASILLOS ELEVADOS • PLATFORMS AND MEZZANINES • LAFERHÜHNEN • PLATES FORMES ET MEZZANINES</p> 