

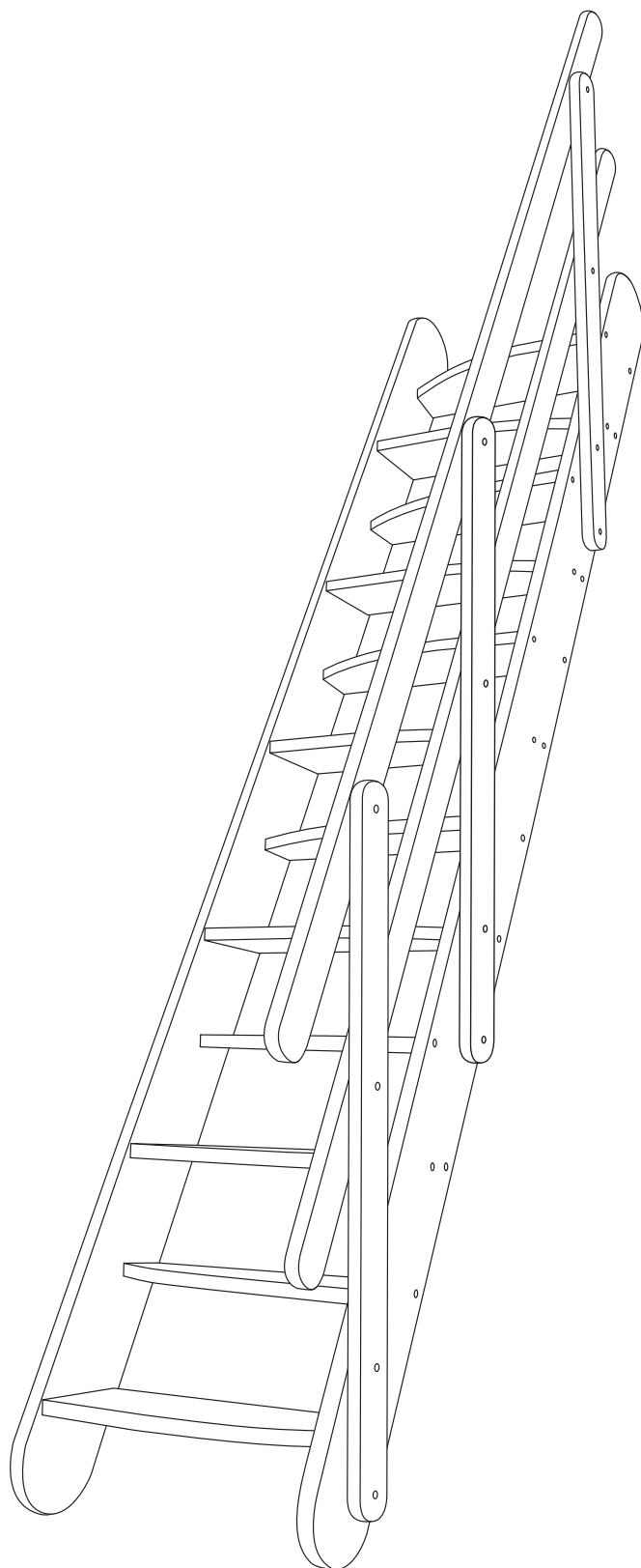

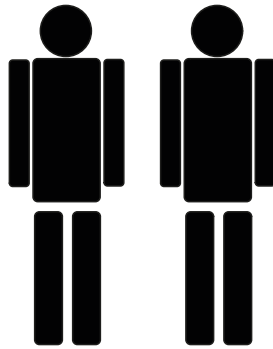



SAMOS

Montageanleitung



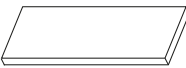
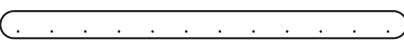
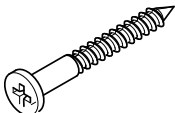
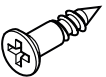

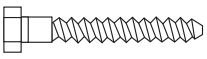
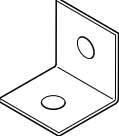
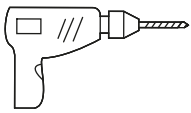
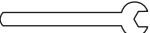
Stückliste

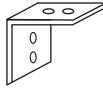

<p>A</p>  <p>Stufen verjüngt</p>  <p>Stufen gerade</p> <p>12x</p>	<p>B</p>  <p>Wangen</p> <p>2x</p>	<p>C</p>  <p>6x60</p> <p>48x</p>
<p>D</p>  <p>5x25</p> <p>12x</p>	<p>E</p>  <p>4x</p>	<p>F</p>  <p>4x</p>
<p>G</p>  <p>4x</p>	   	

Optional: Bei Holzart Fichte

<p>H</p>  <p>36x</p>	<p>I</p>  <p>3,5x16</p> <p>144x</p>
--	---

1

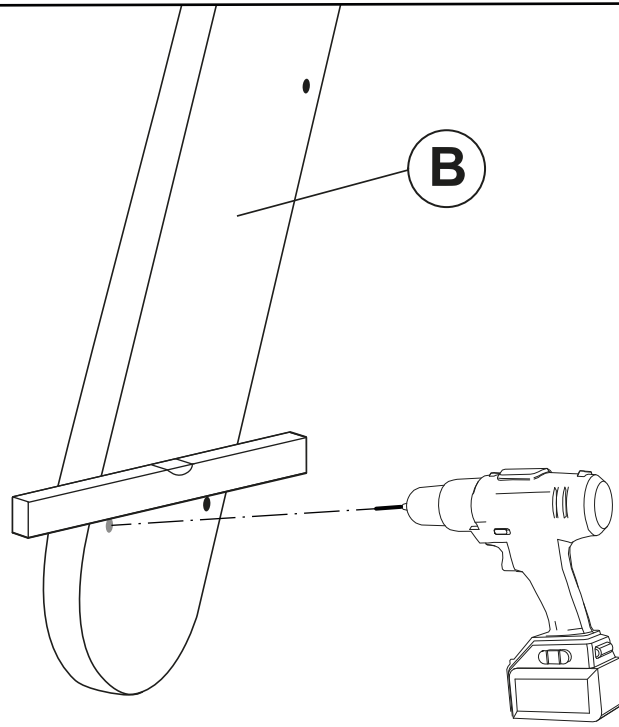

Löcher müssen vorgebohrt werden

2

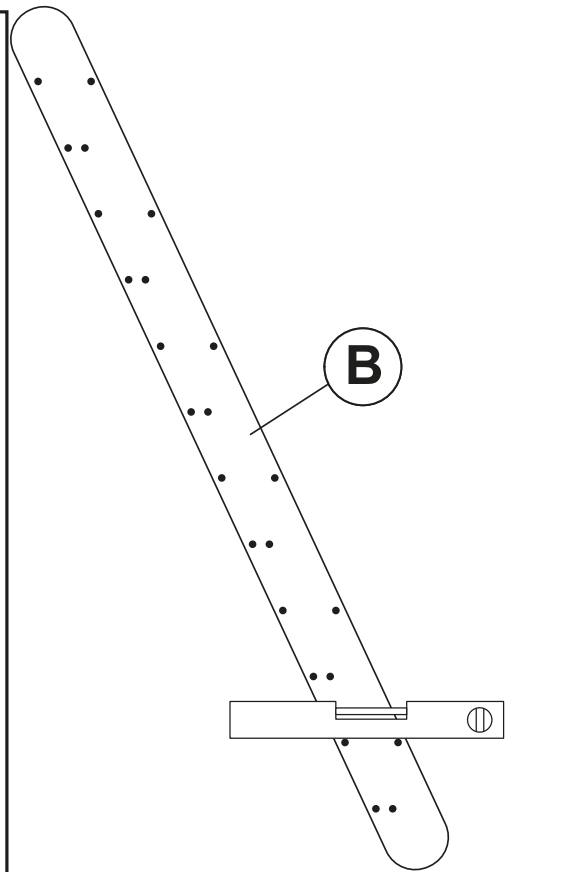

Verjüngt

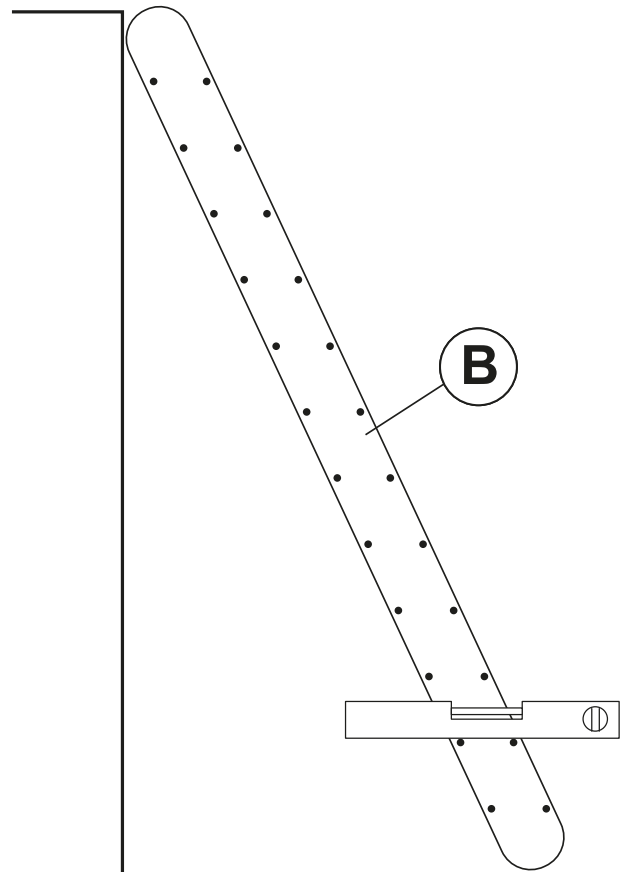

Gerade

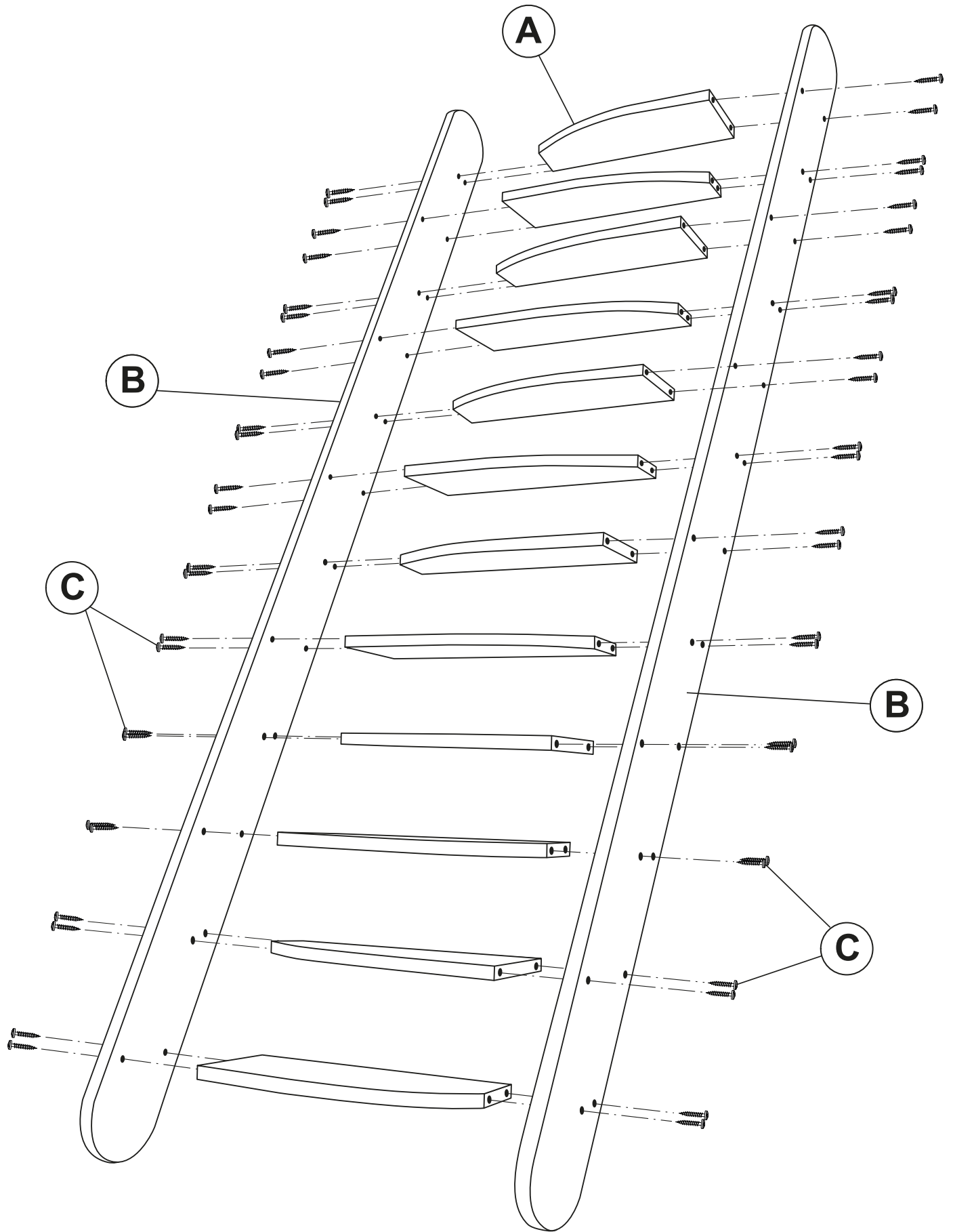

Stufen verjüngt

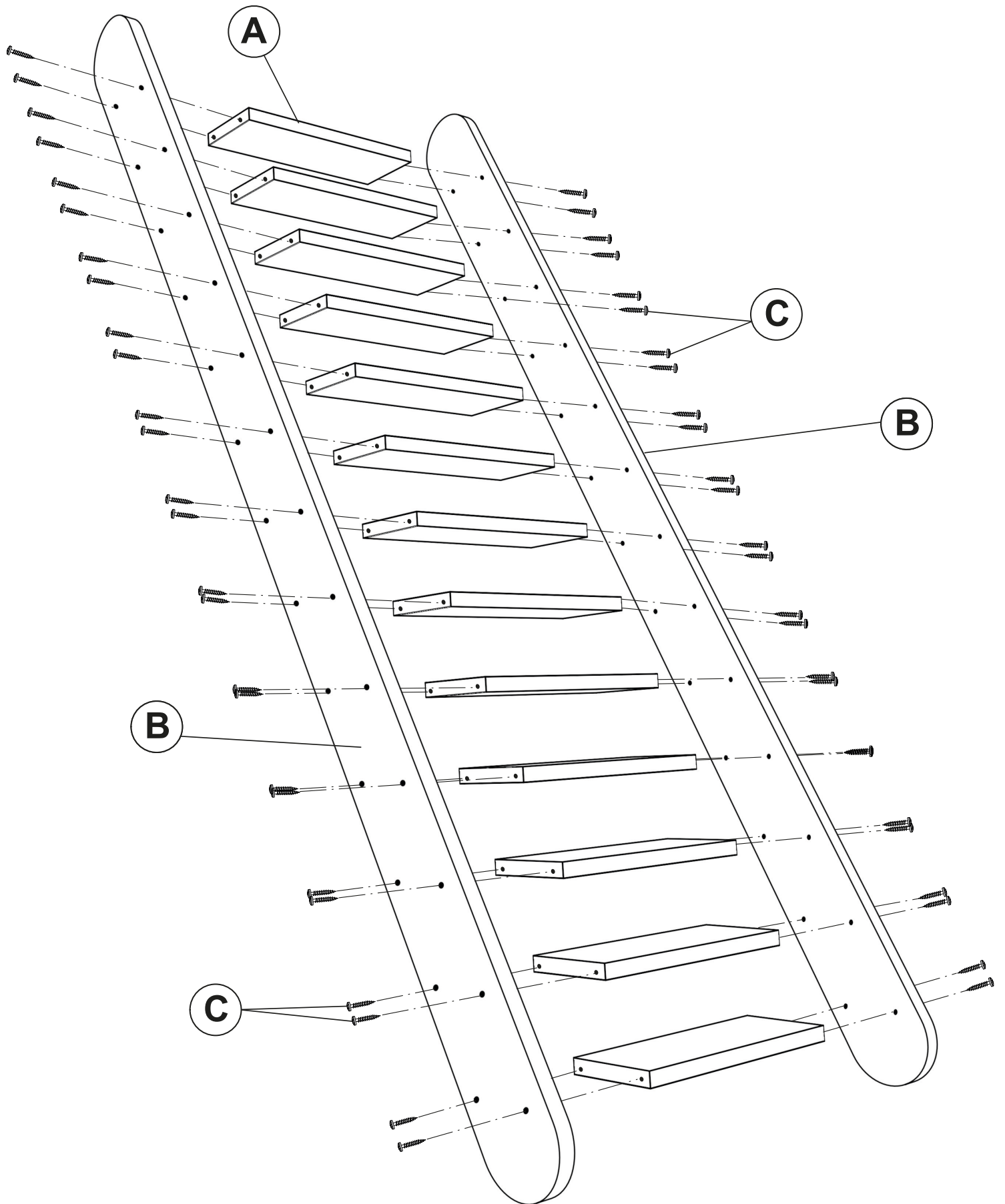

Stufen gerade

