

Louise deluxe

ART. NR. 7850002

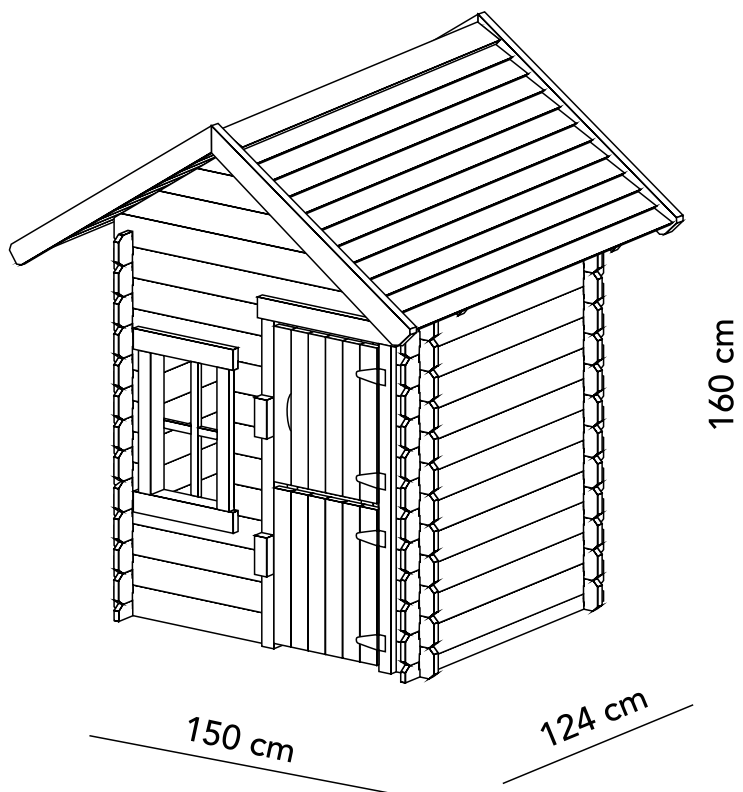

Louise deluxe



I: 105,8 cm x 105,8 cm x 135 cm
E: 150 cm x 124 cm x 160 cm

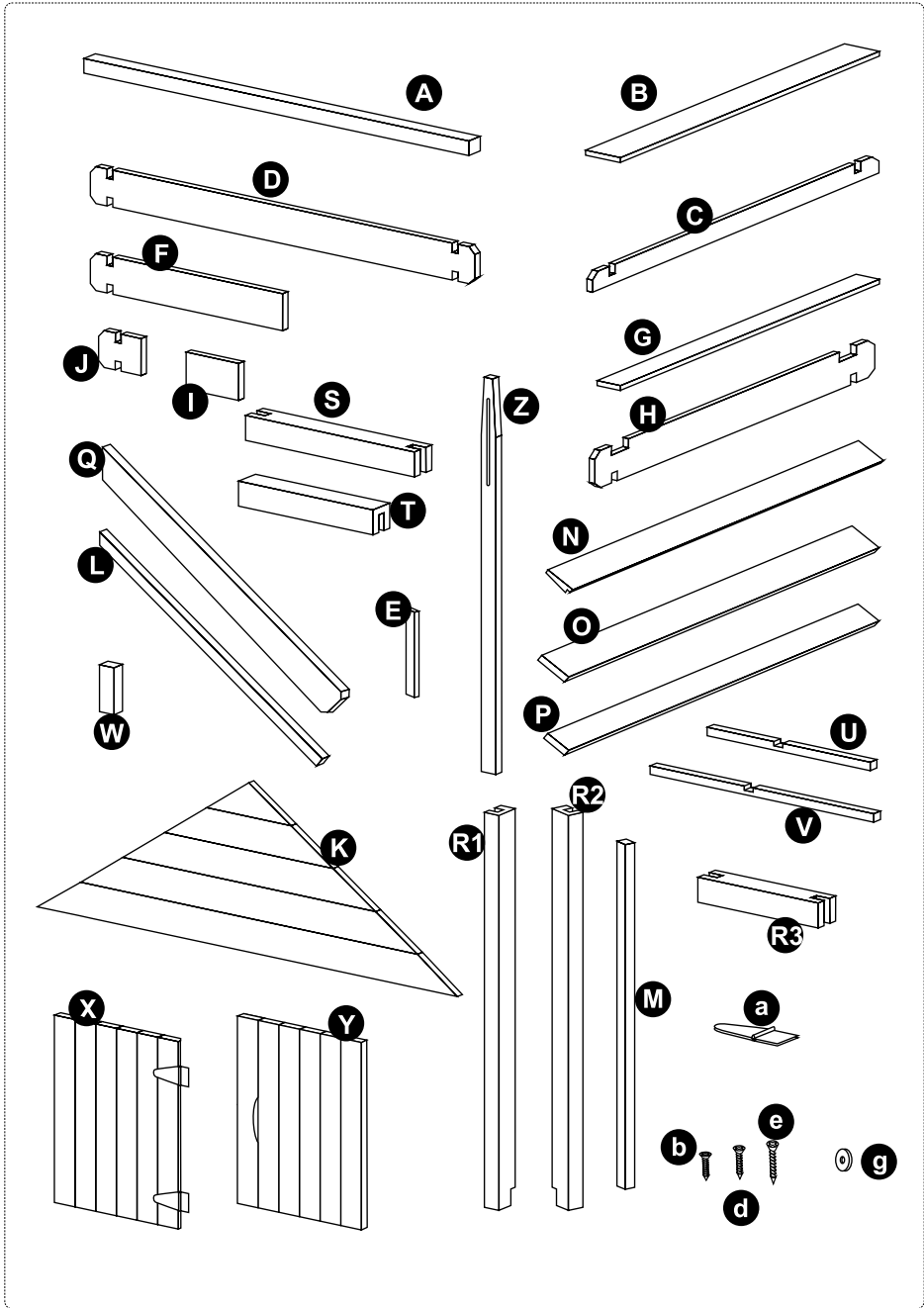

A	4	1068 x 30 x 30
B	11	1068 x 90 x 15
C	2	1200 x 45 x 15
D	35	1200 x 90 x 15
E	1	180 x 43 x 15
F	6	590 x 90 x 15
G	1	1068 x 65 x 15
H	2	1200 x 67 x 15
I	5	140 x 90 x 15
J	16	160 x 90 x 15
K	2	1180 x 458 x 30
L	4	900 x 50 x 25
M	1	1066 x 45 x 15
N	22	1200 x 90 x 16
O	1	1200 x 67 x 15
P	1	1200 x 45 x 15
Q	4	960 x 65 x 15
R1 & R2	2	945 x 65 x 40
R3	1	610 x 65 x 40
S	2	450 x 65 x 40
T	2	375 x 65 x 40
U	1	285 x 25 x 15
V	1	420 x 25 x 15
W	2	105 x 45 x 15
X & Y	2	450 x 380 x 30
Z	2	1200 x 67 x 15
a	4	
b	20	3x16
d	61	3,5x25
e	94	3,5x35
g	2	Ⓣ

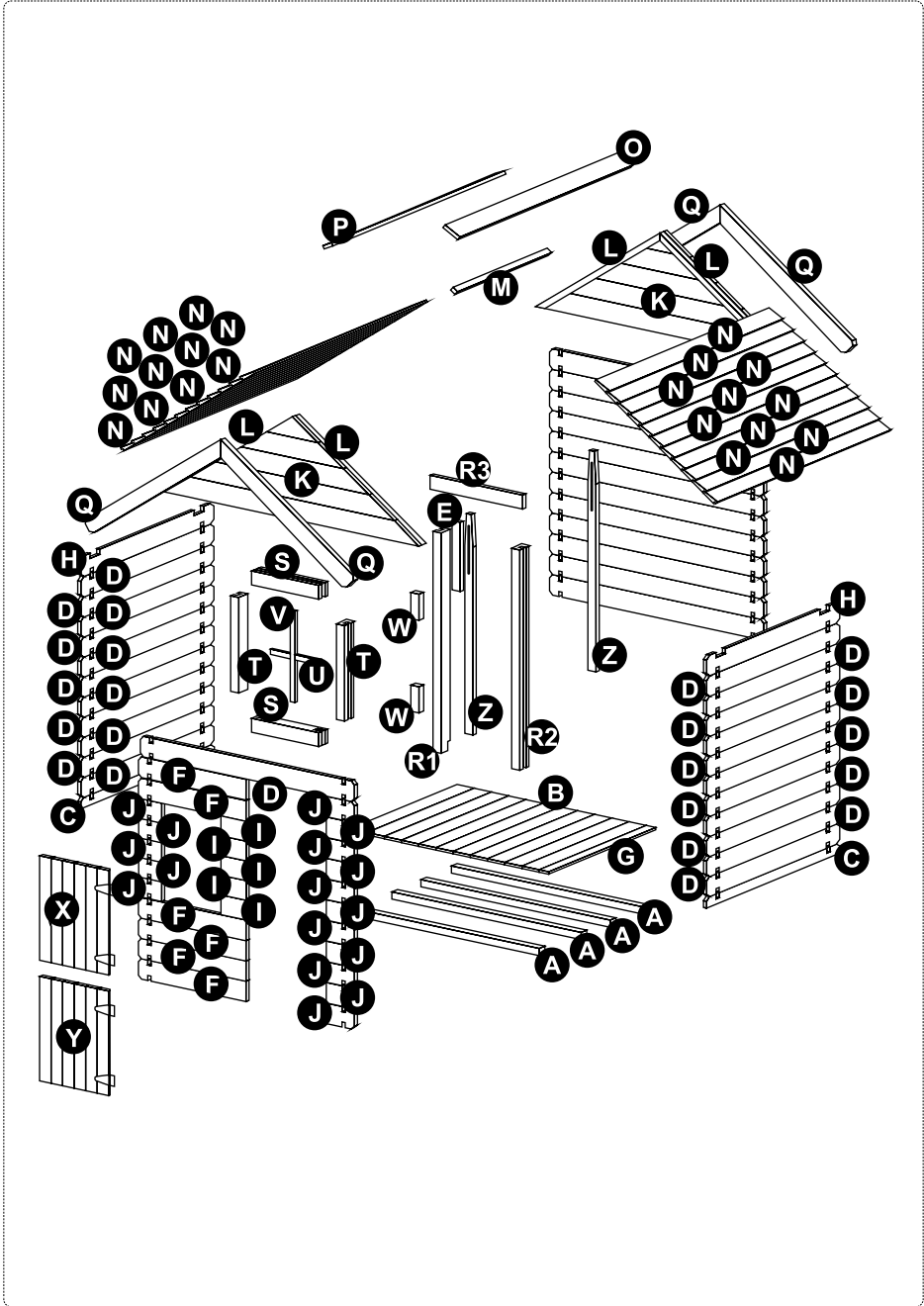

1

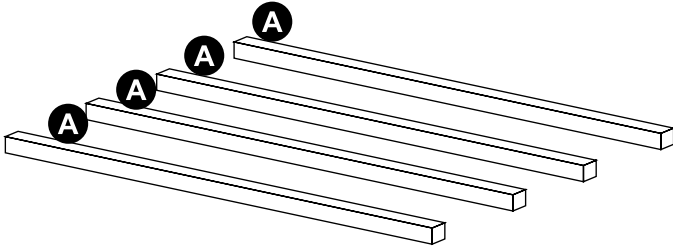

48 x  e

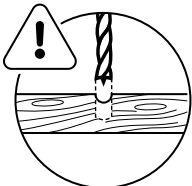
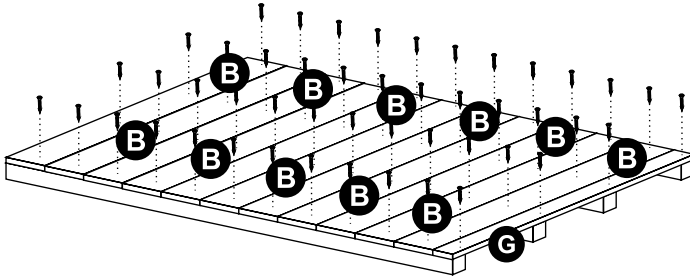

Ø 2,5 mm

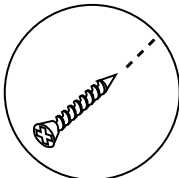

2

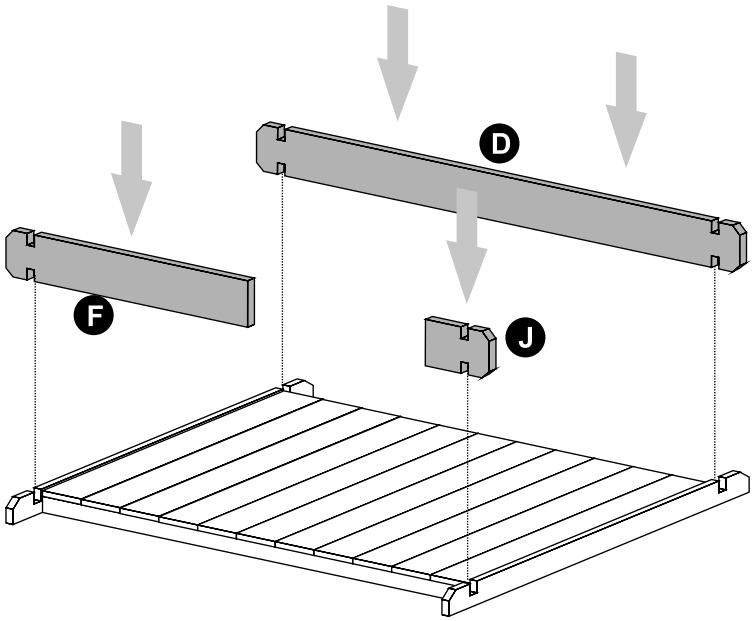
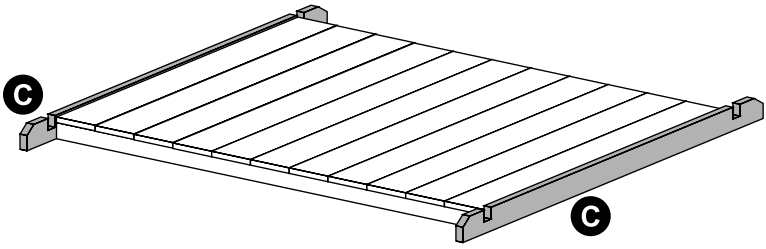

3

9 x  **e**

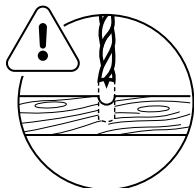
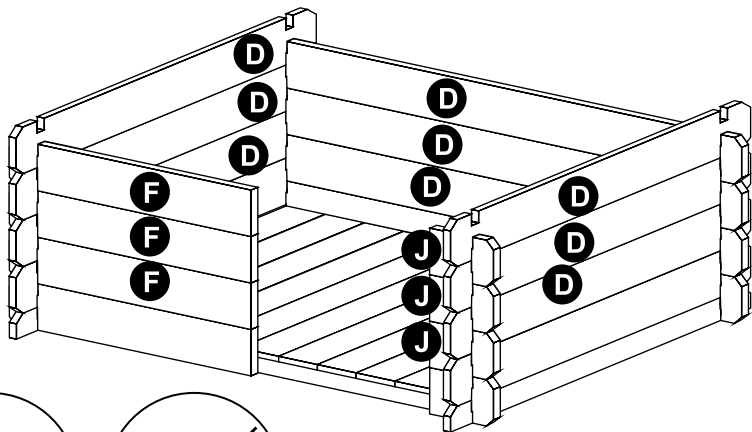
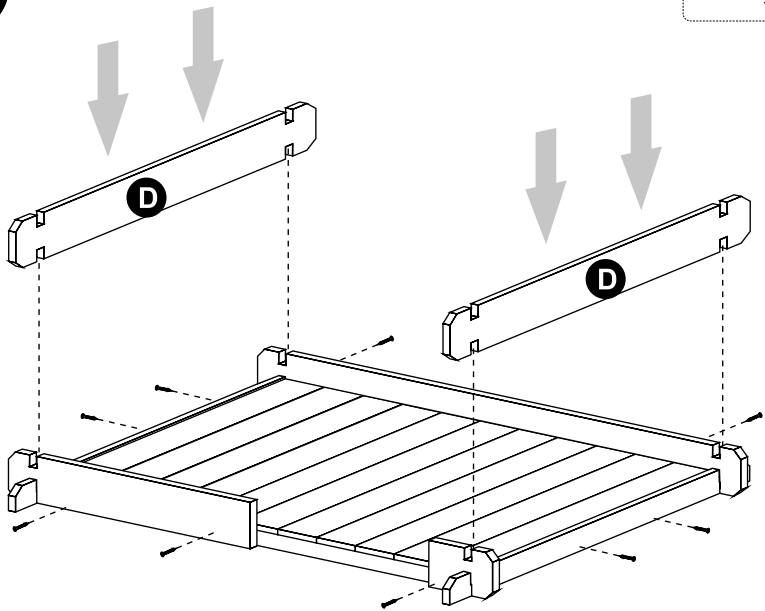

Ø 2,5 mm

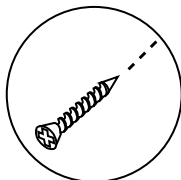

4

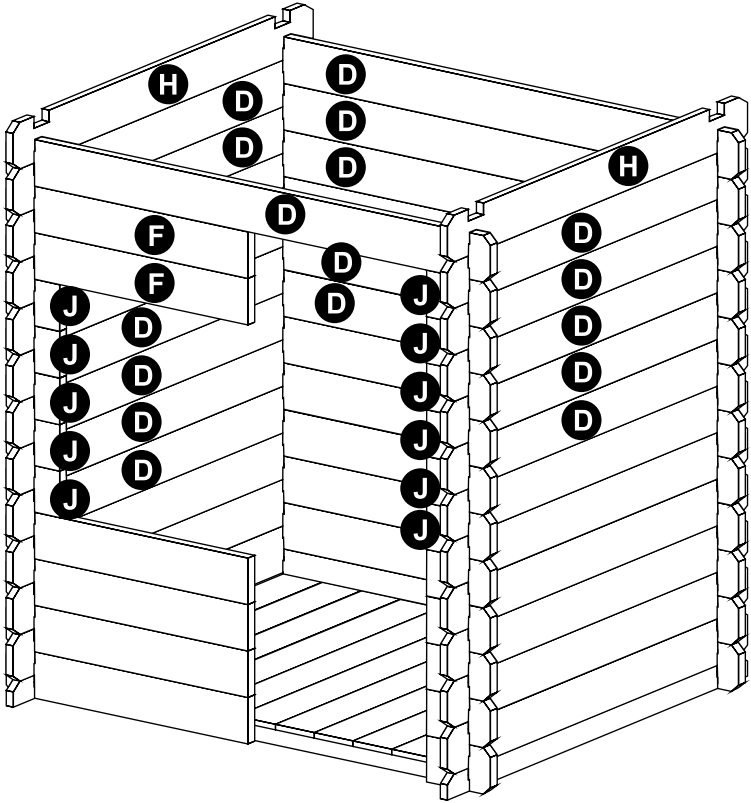

5

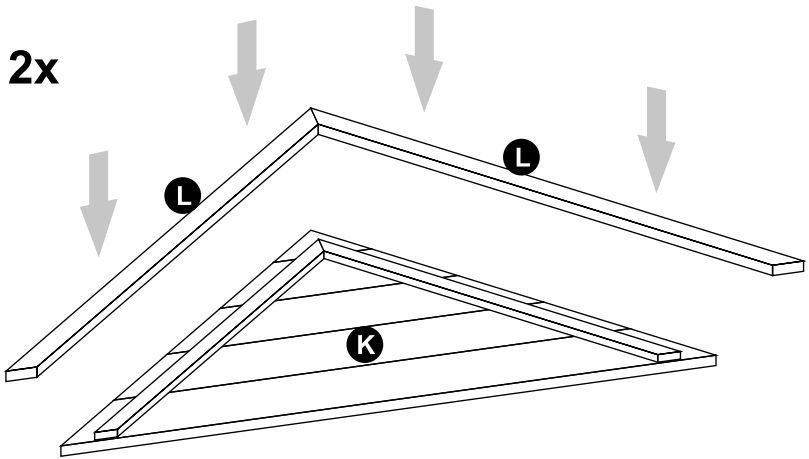

2x

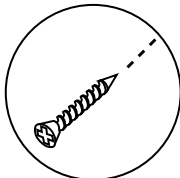
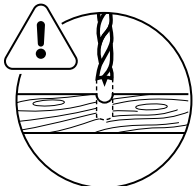
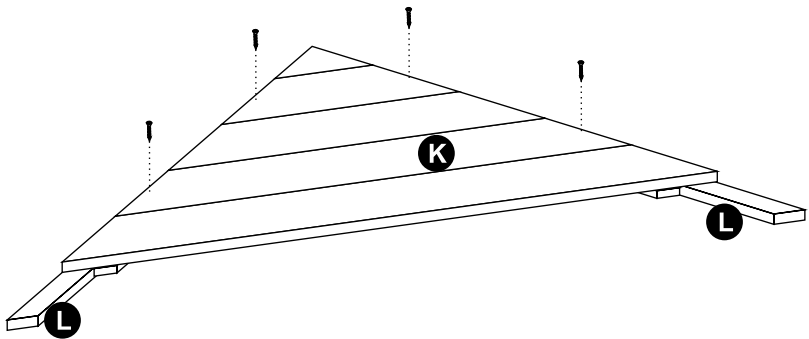
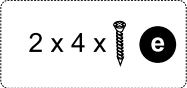

Ø 2,5 mm

6

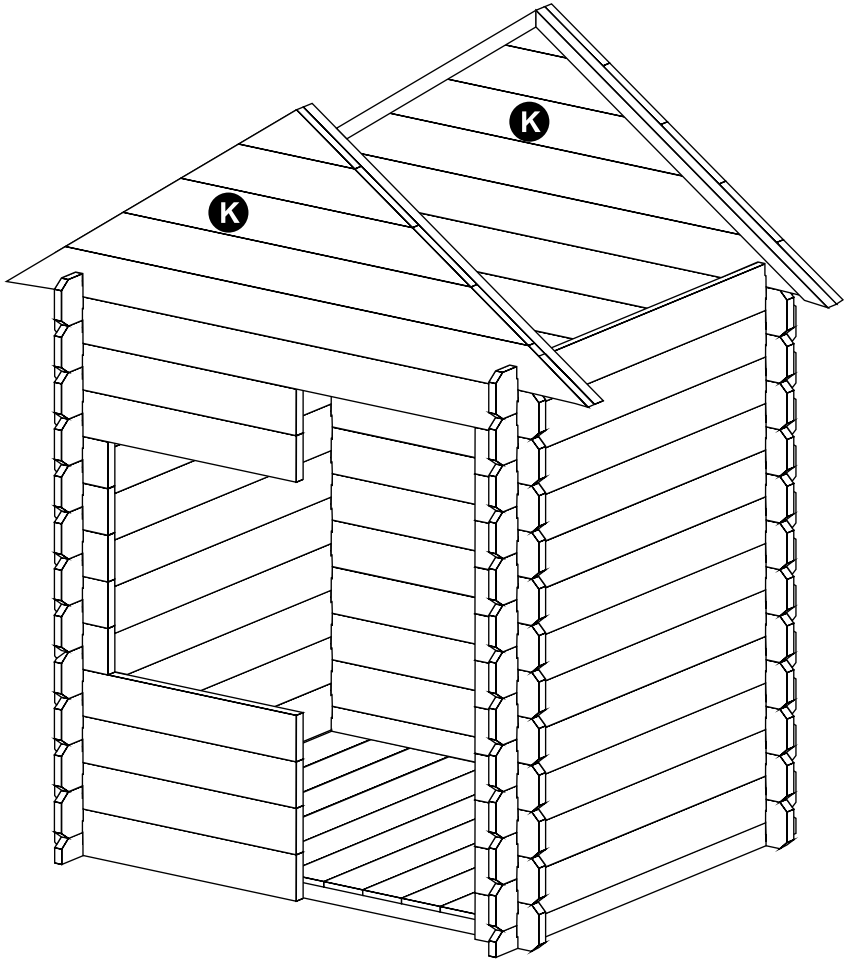

7

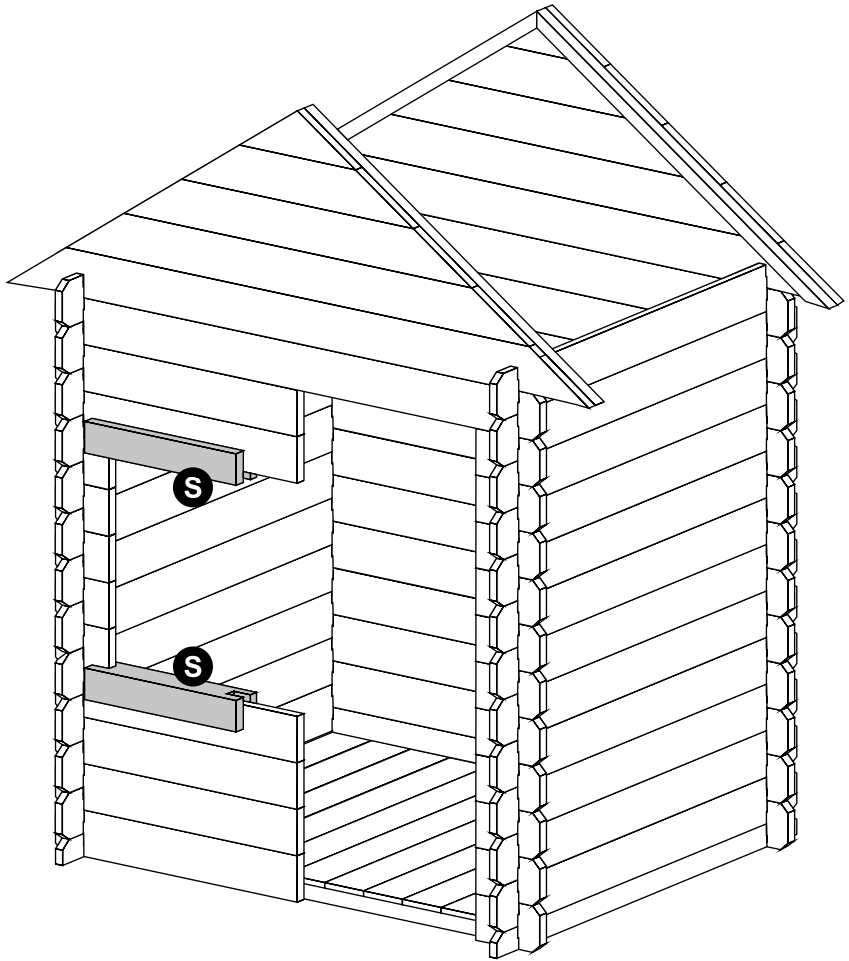

8

2 x  **e**

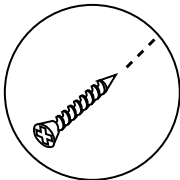
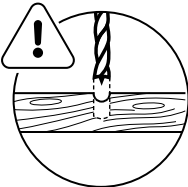
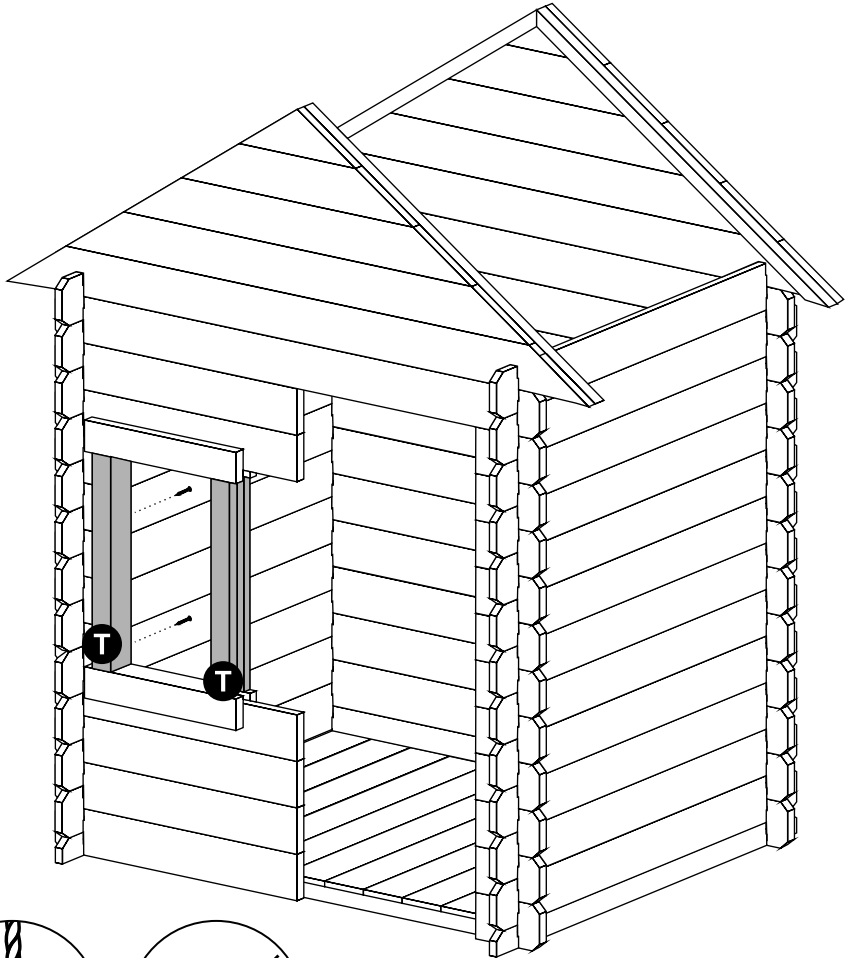

Ø 2,5 mm

9

2 x  e

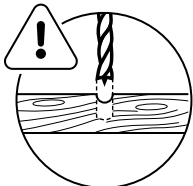
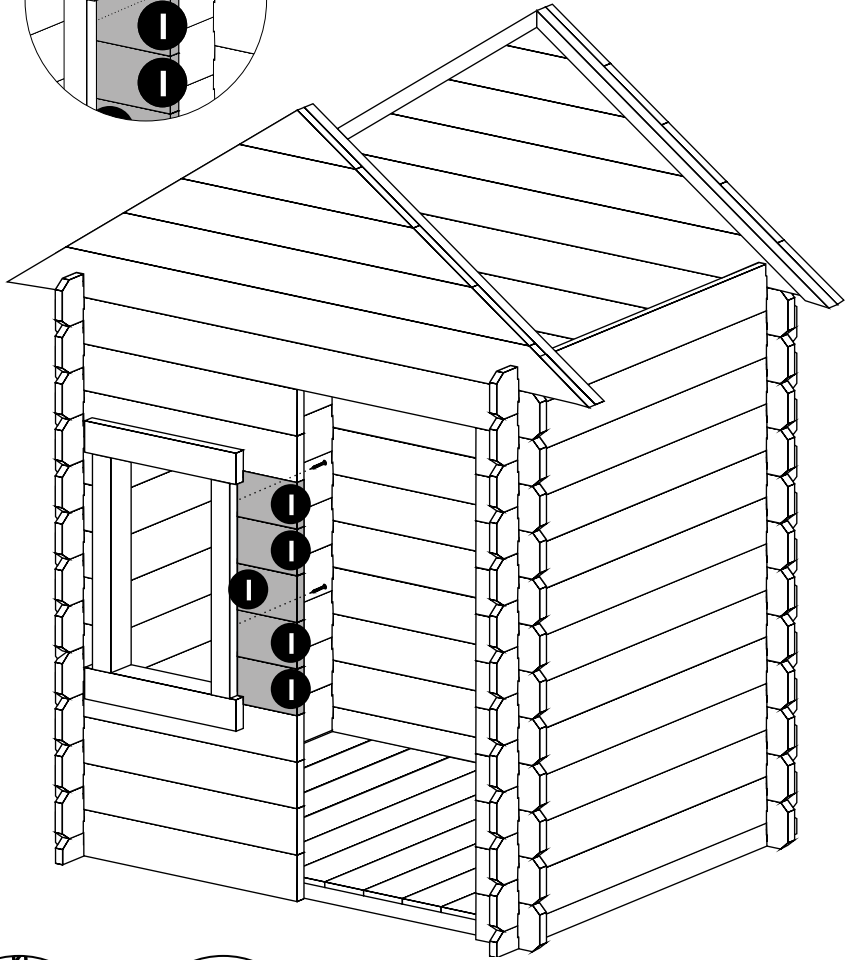
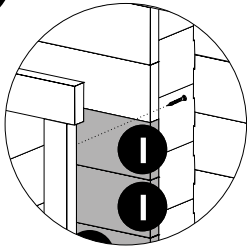

Ø 2,5 mm

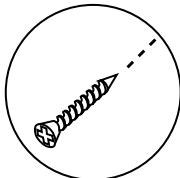

10

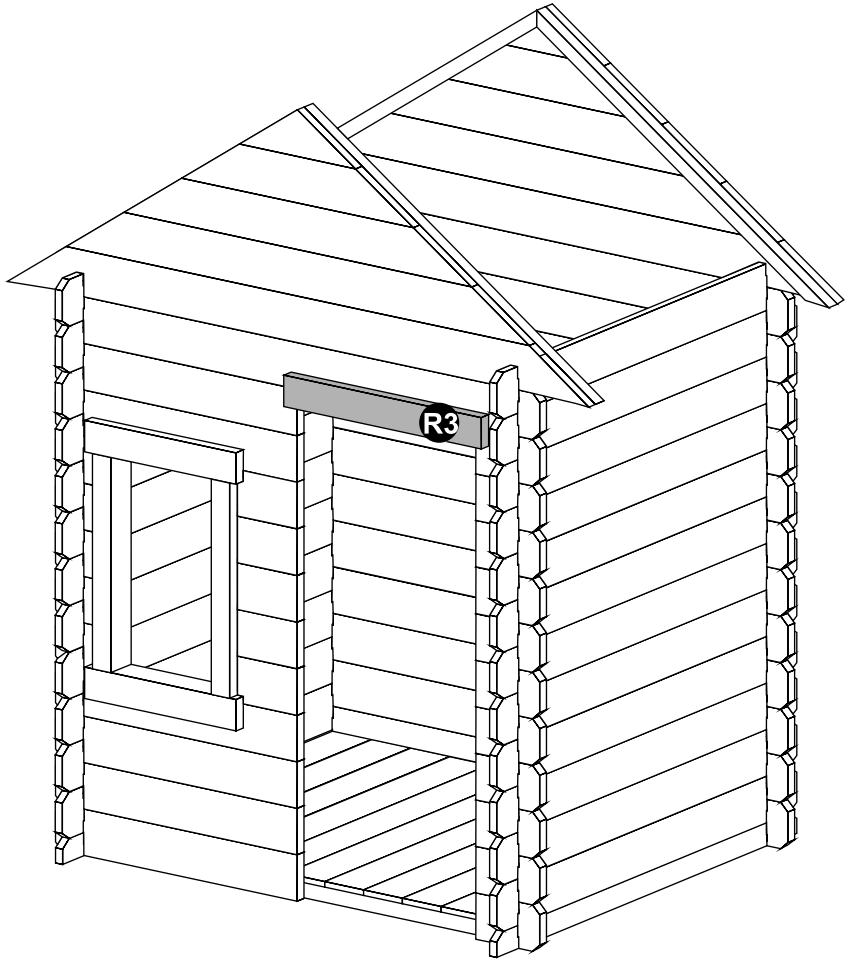

11

8 x  e

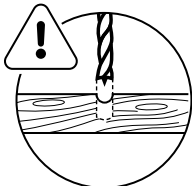
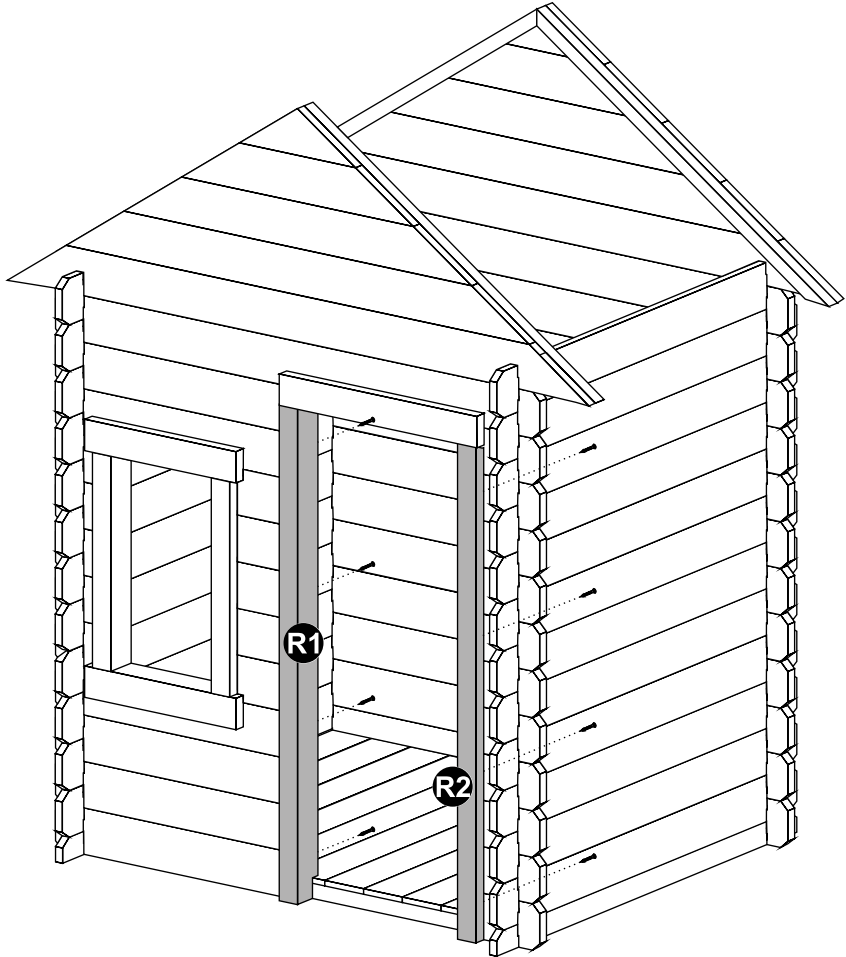

Ø 2,5 mm

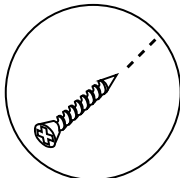

12

2 x  e

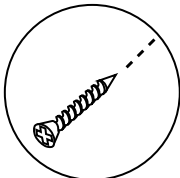
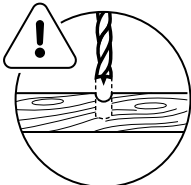
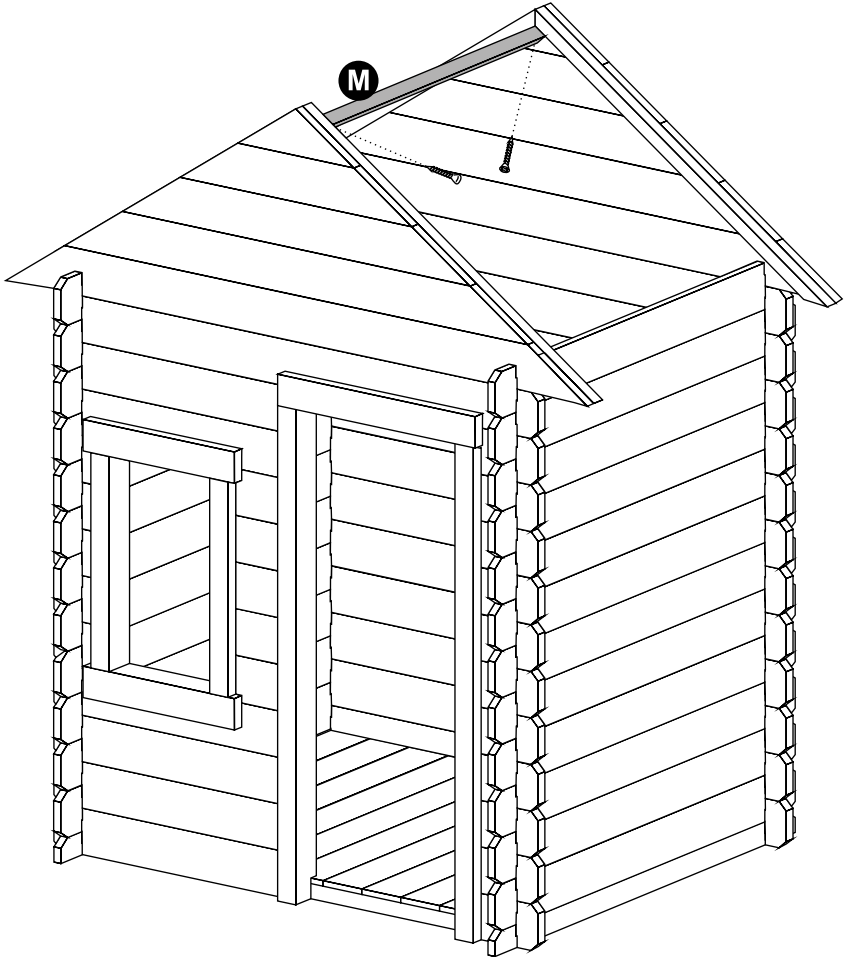

Ø 2,5 mm

13

22 x  d

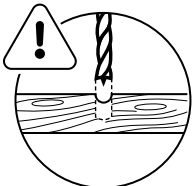
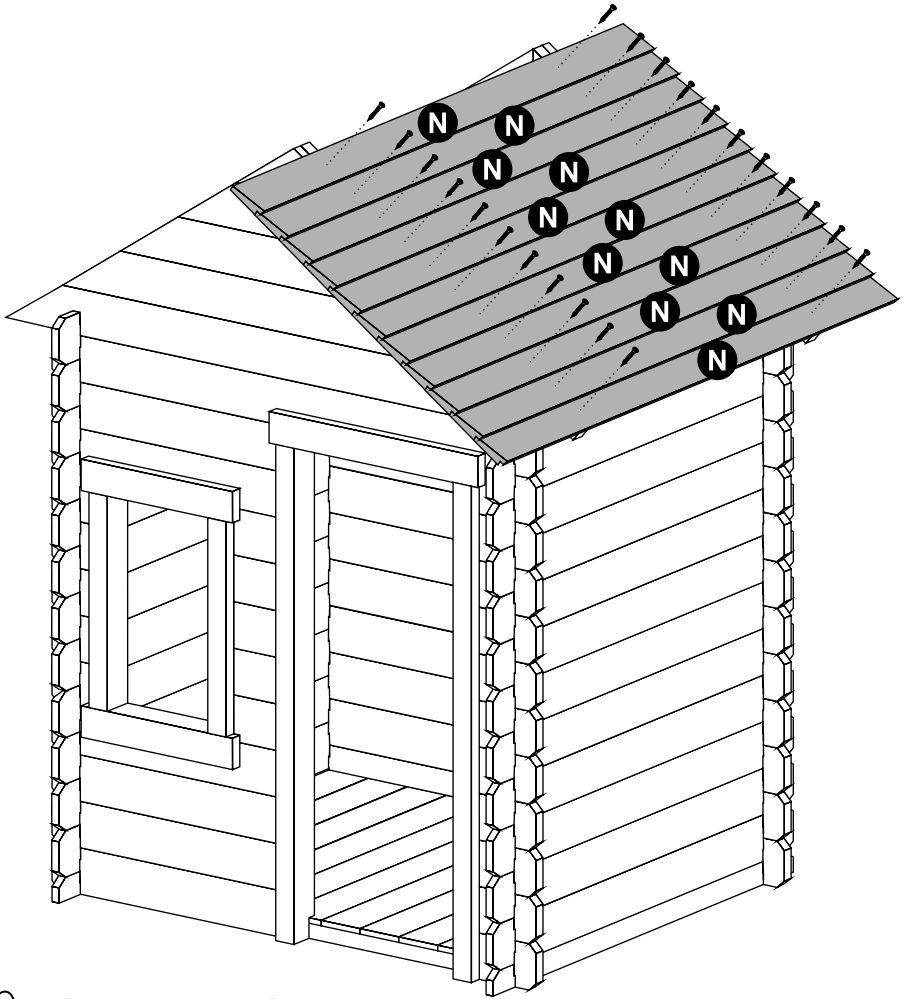

Ø 2,5 mm

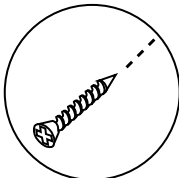

14

22 x  **d**

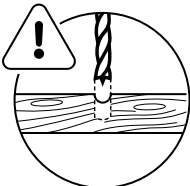
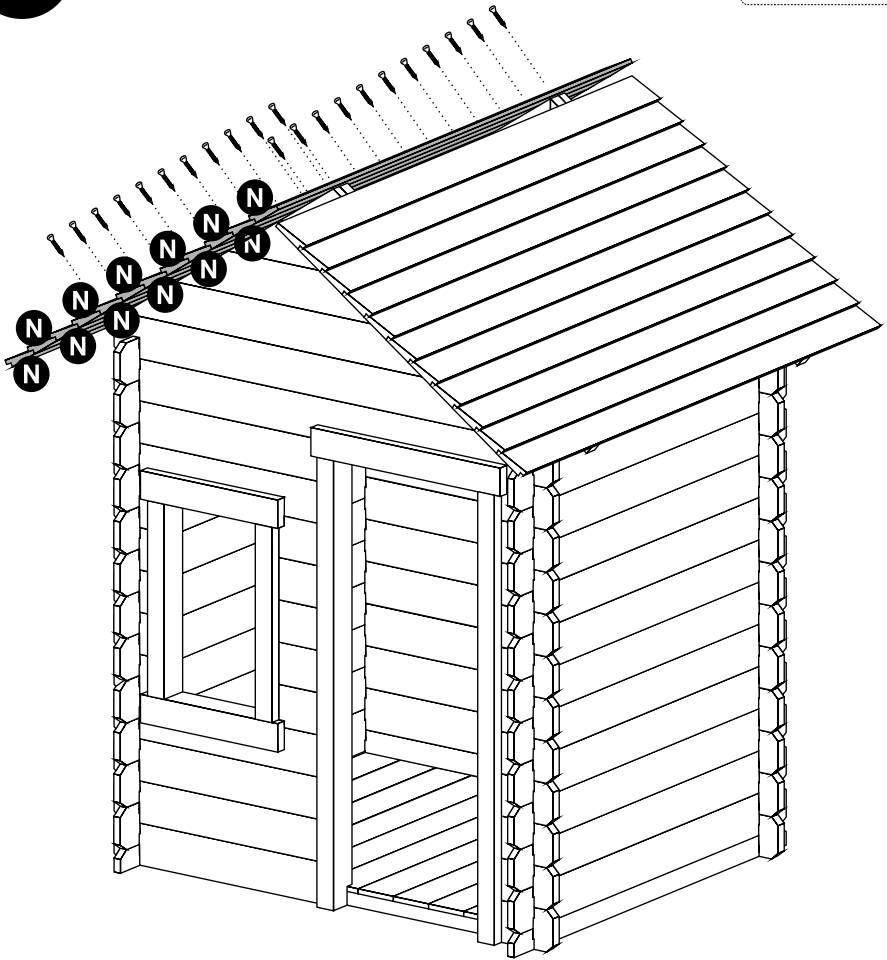

Ø 2,5 mm

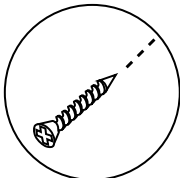

15

3 x  **d**

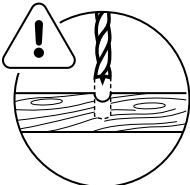
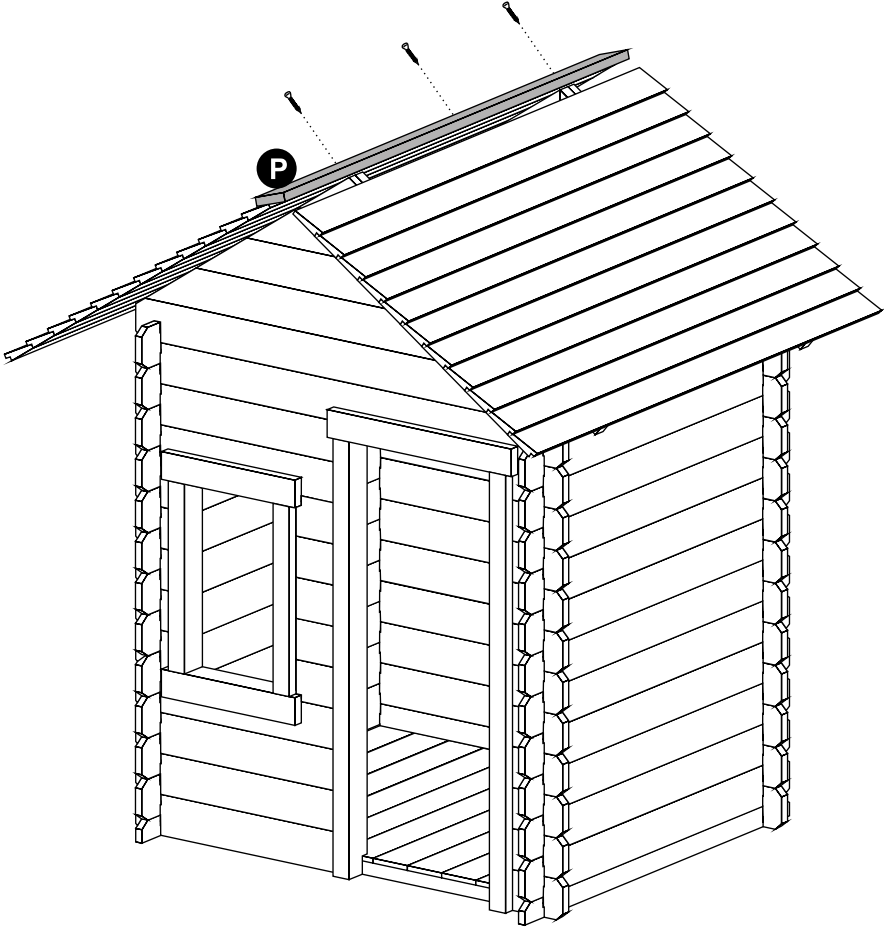

Ø 2,5 mm

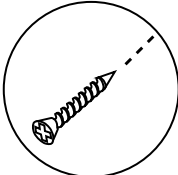

16

5 x  **d**

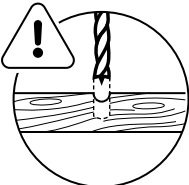
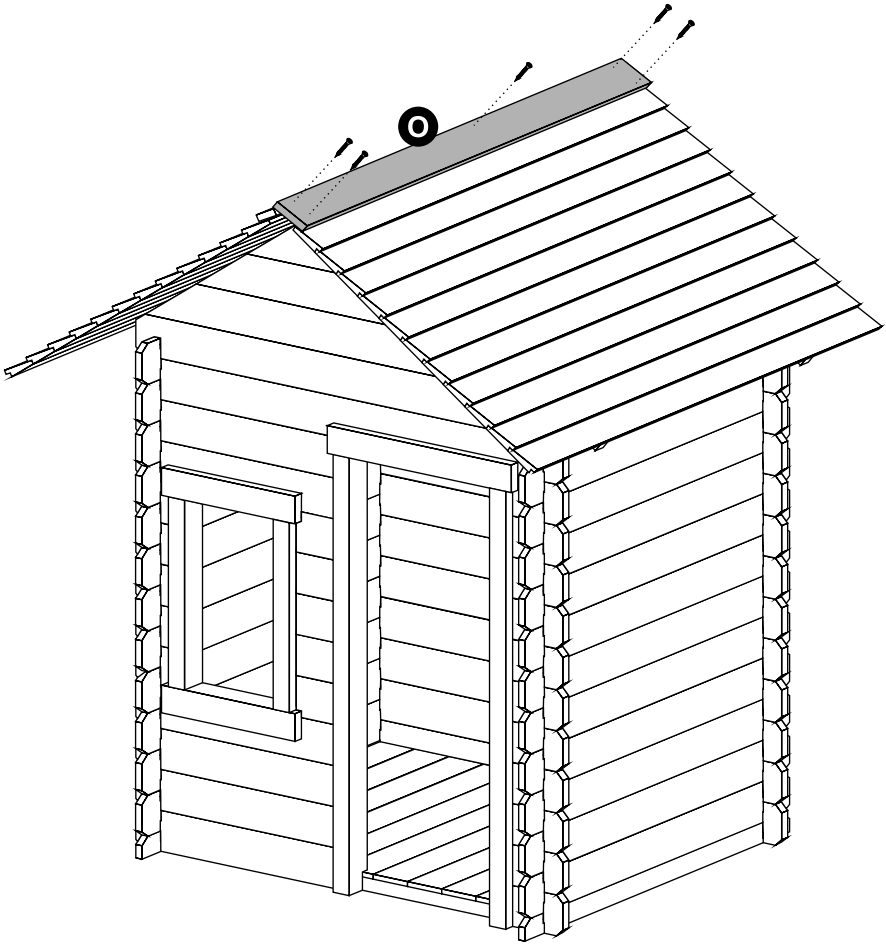

Ø 2,5 mm

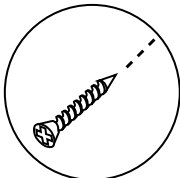

17

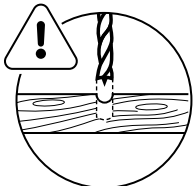
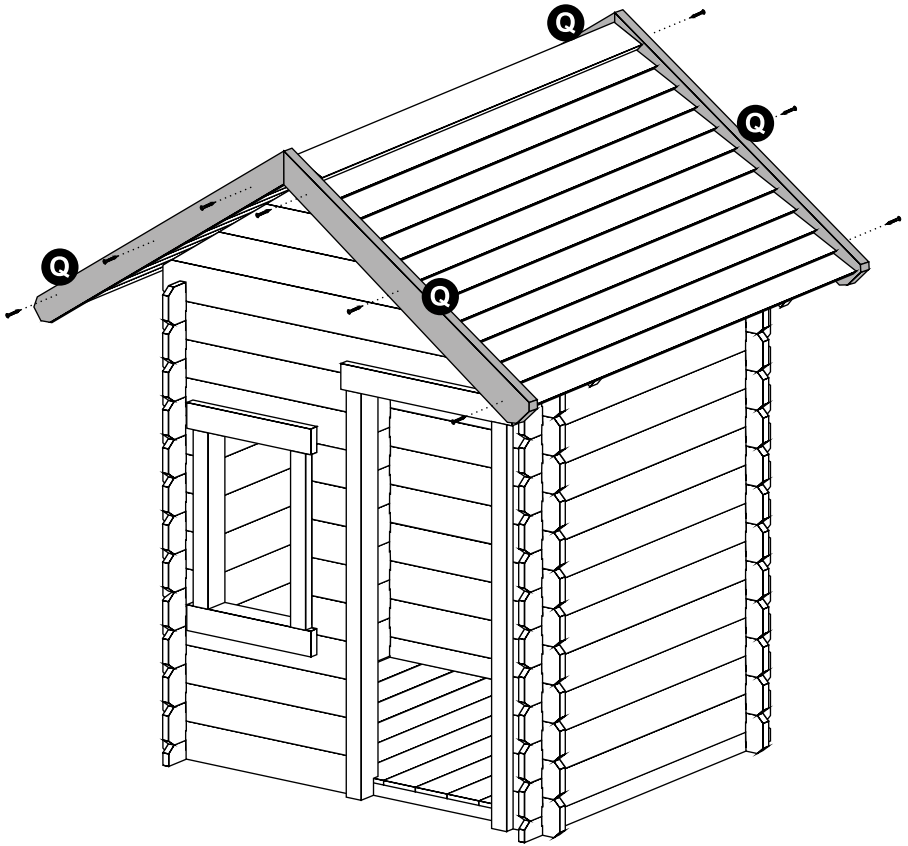

12 x  e

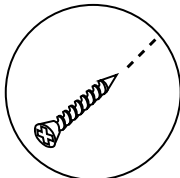

Ø 2,5 mm



18

1 x  e (Z + E) 5 x  d
2 x  g

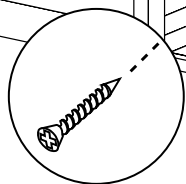
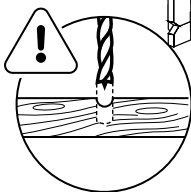
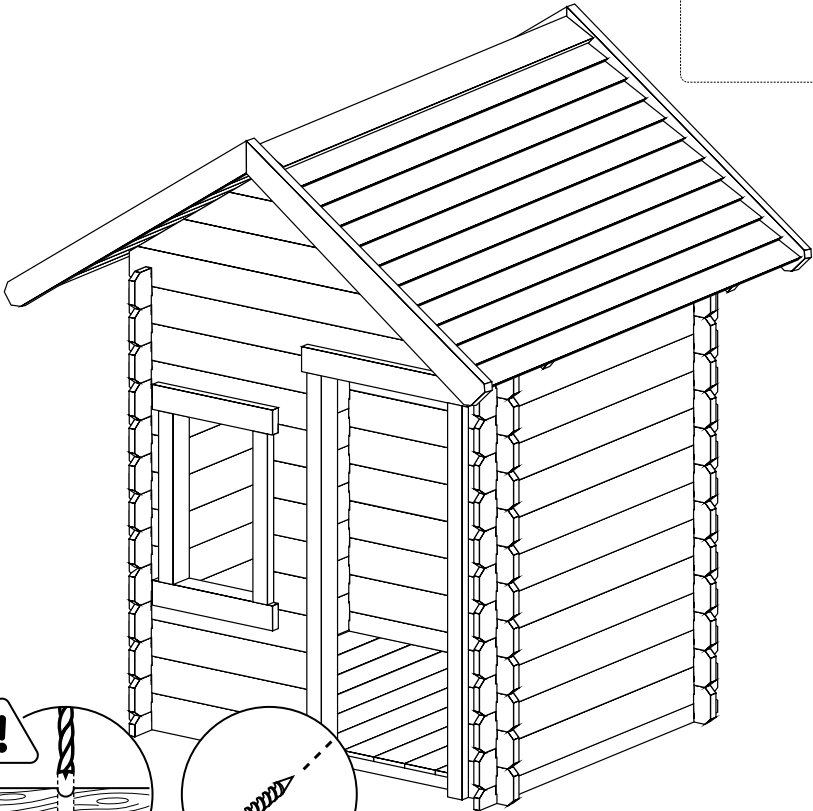
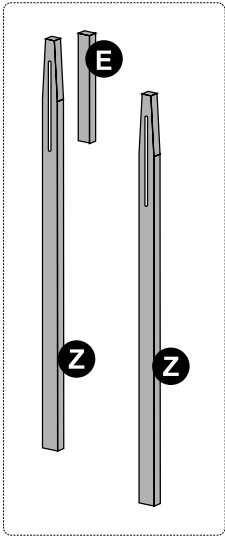

Ø 2,5 mm

19

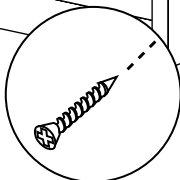
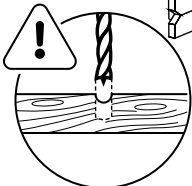
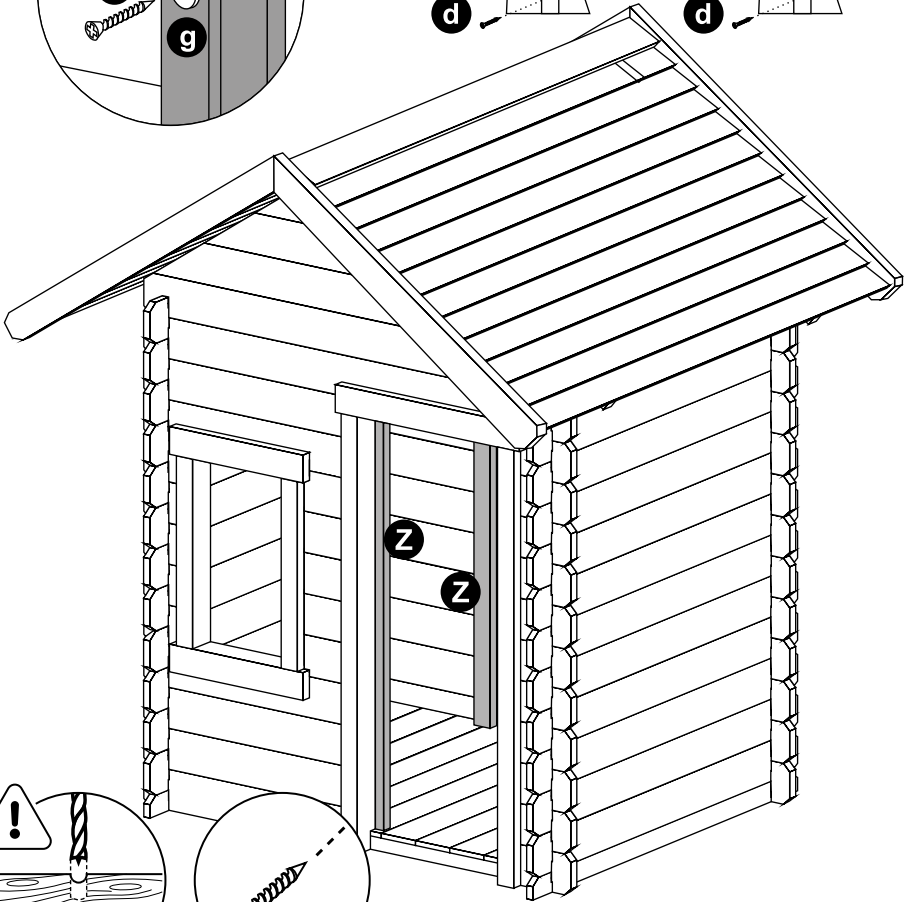
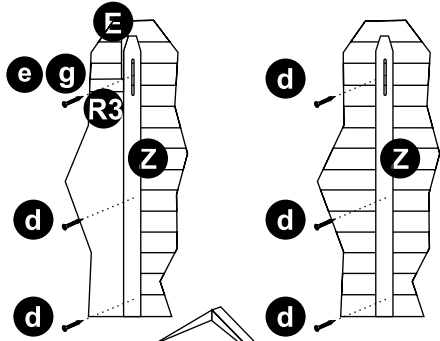
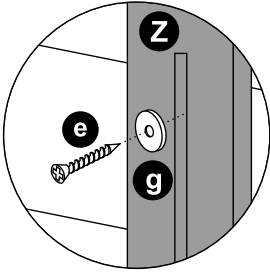

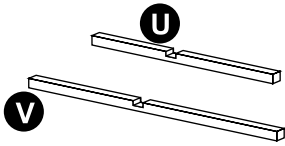

Ø 2,5 mm

20

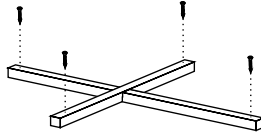
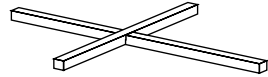

4 x  **d**



4 x  **a**
8 x  **b**

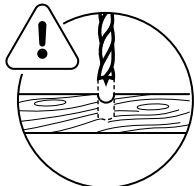
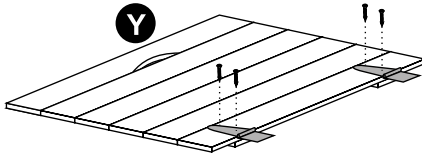

Ø 2,5 mm

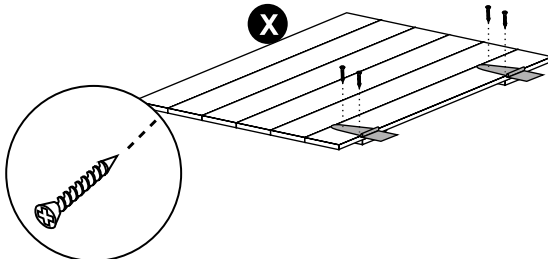

21

2 x  **e**

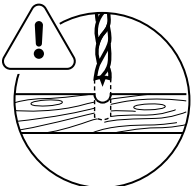
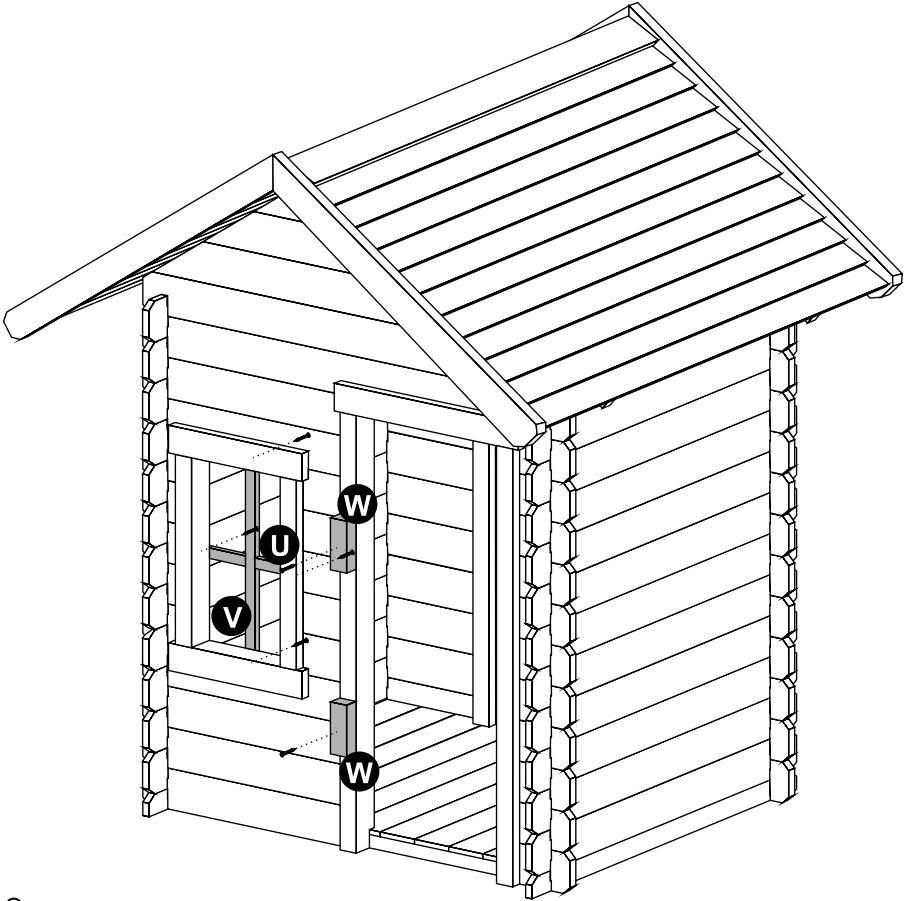

Ø 2,5 mm

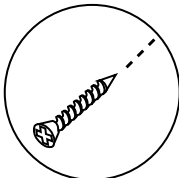

22

12 x  **b**

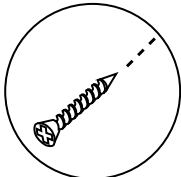
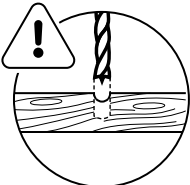
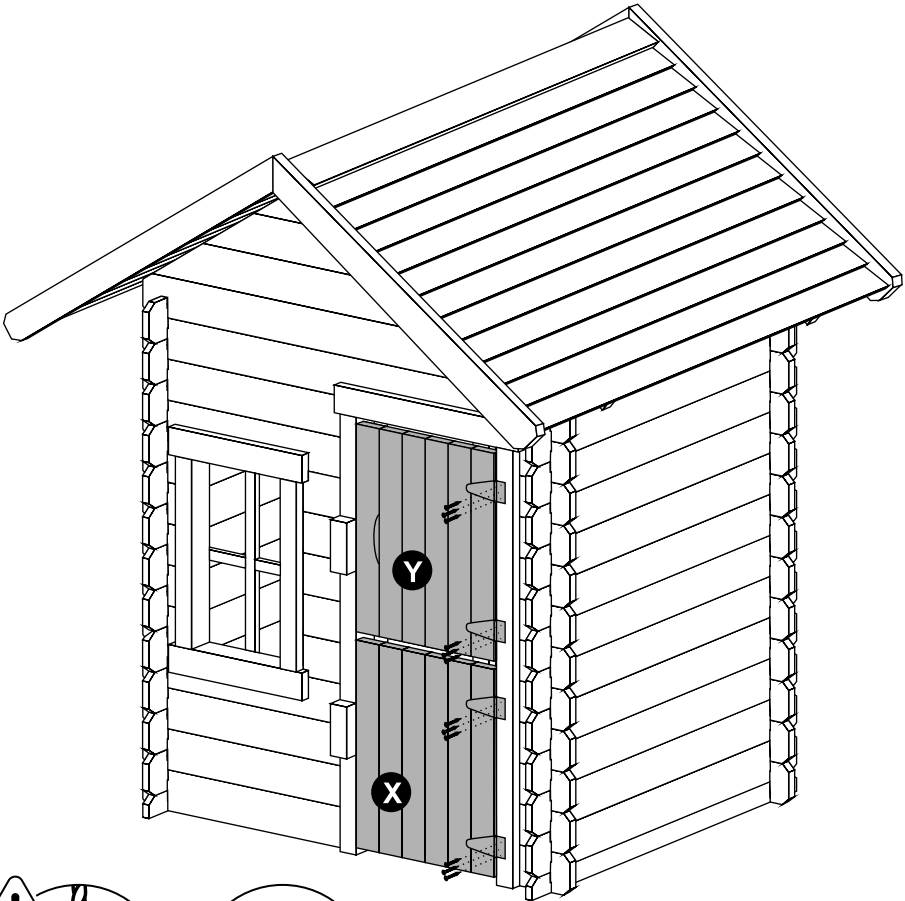

Ø 2,5 mm

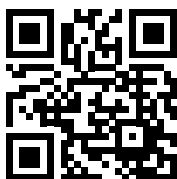

Scan for terms
and conditions

+31(0)318 692 221
www.swingking.nl

Swing King IS A BRAND OF:

HAPRO INTERNATIONAL



8 717306 719971 >