

Valves / Válvulas / Vanes Egeo - Tifana - Elegance

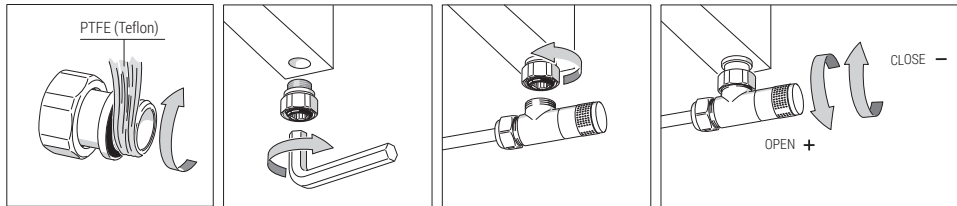

Lockshield / Detentor / Retentor / Vanne d'arrêt Tifana

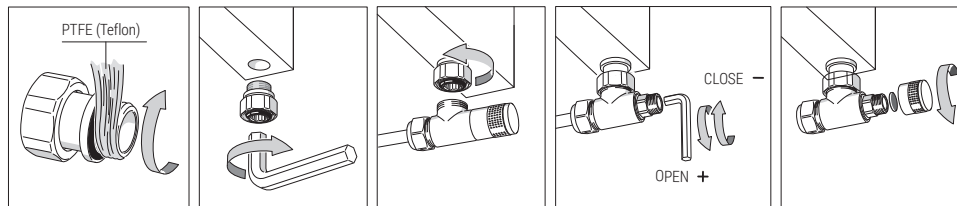

Monotube valve / Válvula monotubo / Vanne monotube Hydra

MONOTUBE Standard version MONOTUBO Versión estándar MONOTUBO Versão standard MONOTUBE Version standard BITUBO BITUBE BITUBE



ENTRY IN A INPUT IN B. Rotate 0421/2 180°
 ENTRADA EN A ENTRADA EN B. Rotar 0421/2 180°
 ENTRADA EM A ENTRADA EM B. Rotar 0421/2 180°
 ENTRÉE DANS A ENTRÉE DANS B. Rotation 0421/2 180°
 (Estándar / Standard)

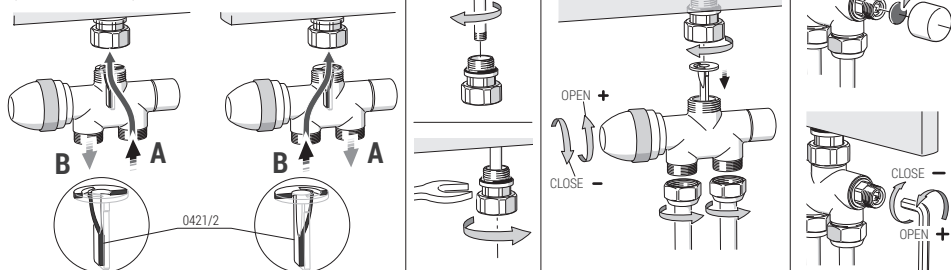

Valves / Válvula monotubo / Vanne monotube Pegasus

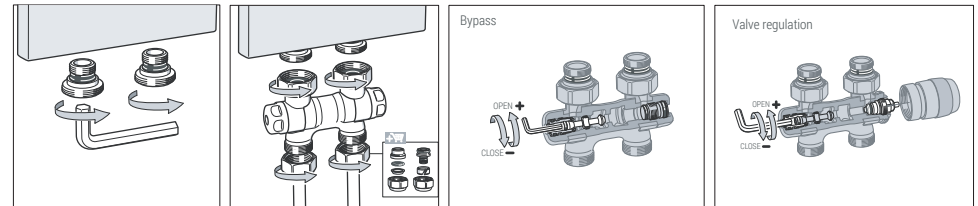

Thermostatic head / Cabeza termostática / Cabeça termostática / Tête thermostatique Teseus

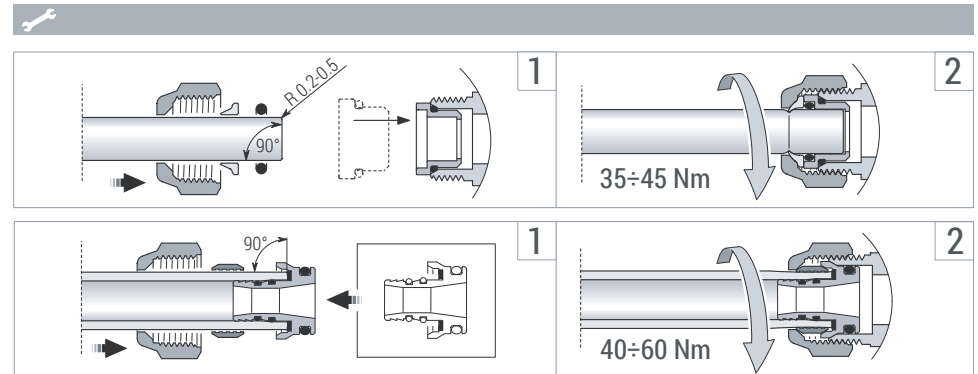
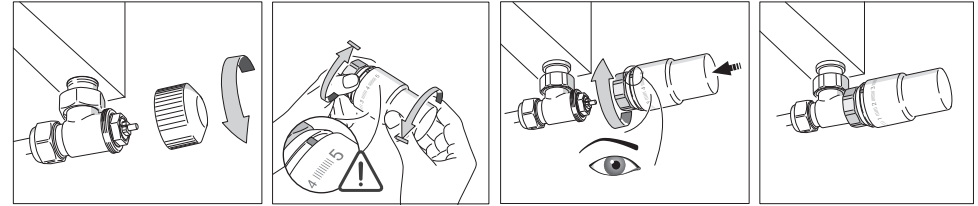

Performance / Rendimiento / Desempenho

Valves / Válvula / Vanne
 EGEO - TIFANA - ELEGANCE - HYDRA - PEGASUS

Employed fluid / Fluido usado / Fluide utilisé
 Water, antifreeze solutions / Agua, anticongelantes
 Agua, anticongelantes / Eau, antigel
 Max. % glycol / % máx. glicol / % max. de glycol
 30%
 Max. pressure / Presión máx. / Pressão máx. / Pression max.
 10 bar
 Max. temp. / Temperatura máx. / Température max.
 100°C
 *Min. settable temperature / Temp. mín. regulable
 Temp. mín. ajustável / Température minimale réglable
 7°C

Valves / Válvula / Vanne
 TESEUS

Adjustment scale / Escala ajustable / Escala regulável
 Échelle réglable
 * 3
 Temp. ranges / Rangos temp. / Gamas temp. / Plages de temp.
 7 = 28°C
 Frost protection / Protección contra heladas / Protecção anti-gelo
 Protection antigel
 16°C / 61°F
 20°C / 68°F
 24°C / 75°F
 28°C / 82°F
 Max. room temp. / Temp. ambiente máx. / Temp. máx. da sala
 Temp. ambiente max.
 50°C
 Min. settable temperature / Temp. mín. regulable
 Temp. mín. ajustável / Température minimale réglable
 7°C

0°C / 32°F	0
7°C / 45°F	*
12°C / 54°F	1
16°C / 61°F	2
20°C / 68°F	3
24°C / 75°F	4
28°C / 82°F	5

EGEO

Valves
Válvula
Vanne

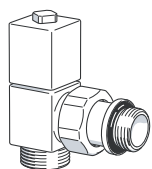

White / Blanco / Branco / Blanc VTIEB01
 Chrome / Cromado / Cromado / Chromé VTIEC01
 Satin SS / Satinado Inox / Cetim Inox / Inox Satiné VTIEI01

TIFANA

Lockshield
Detentor
Retentor
Serrure

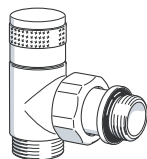

White / Blanco / Branco / Blanc VTITB01
 Chrome / Cromado / Cromado / Chromé VTITC01
 Black / Negro / Preto / Noir VTITN01
 Satin SS / Satinado Inox / Cetim Inox / Inox Satiné VTITS01

TIFANA

Valves
Válvula
Vanne

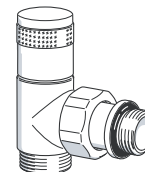

White / Blanco / Branco / Blanc VTITB02
 Chrome / Cromado / Cromado / Chromé VTITC02
 Black / Negro / Preto / Noir VTITN02
 Satin SS / Satinado Inox / Cetim Inox / Inox Satiné VTITS02

HYDRA

Valves
Válvula
Vanne

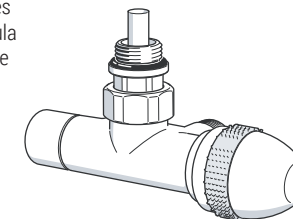

White / Blanco / Branco / Blanc VTIHB01
 Chrome / Cromado / Cromado / Chromé VTIHC01
 Black / Negro / Preto / Noir VTIHN01
 Satin SS / Satinado Inox / Cetim Inox / Inox Satiné VTIHS01

ELEGANCE

Valves
Válvula
Vanne

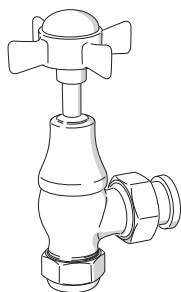

Chrome / Cromado / Cromado / Chromé VTILC01

HYDRA

Valves
Válvula
Vanne

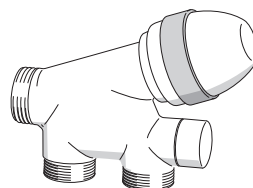

White / Blanco / Branco / Blanc VTIHB02
 Chrome / Cromado / Cromado / Chromé VTIHC02
 Black / Negro / Preto / Noir VTIHN02
 Satin SS / Satinado Inox / Cetim Inox / Inox Satiné VTIHS02

PEGASUS

Valves
Válvula
Vanne

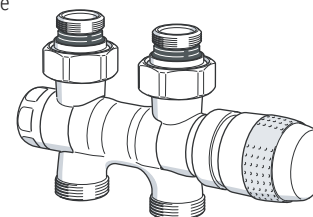

Nickel / Níquel / Níquel / Nickel VTIPQ01

TESEUS

Thermostatic head
Cabeza termostática
Cabeça termostática
Tête thermostatique

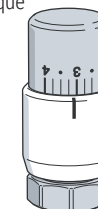

Chrome / Cromado / Cromado / Chromé VTISC01

Copper tube adapters
Adaptadores tubo de cobre
Raccords de tuyaux en cuivre

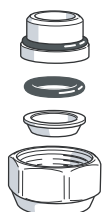

Chrome / Cromado / Cromado / Chromé

ø 12 VTIAC01
 ø 14 VTIAC02
 ø 15 VTIAC03
 ø 16 VTIAC04
 ø 18 VTIAC05

Satin SS / Satinado Inox / Cetim Inox / Inox Satiné

ø 12 VTIAC06
 ø 14 VTIAC07
 ø 15 VTIAC08
 ø 16 VTIAC09
 ø 18 VTIAC10

Multilayer pipe adapters
Adaptadores tubo multicapa
Adaptadores de tubos multicamadas
Raccords de tuyaux multicouches



Chrome / Cromado / Cromado / Chromé

16 x 2 VTIAM01
 18 x 2 VTIAM02
 20 x 2 VTIAM03

Satin SS / Satinado Inox / Cetim Inox / Inox Satiné

16 x 2 VTIAM04
 18 x 2 VTIAM05
 20 x 2 VTIAM06

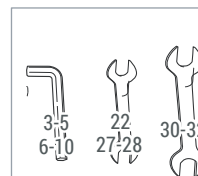
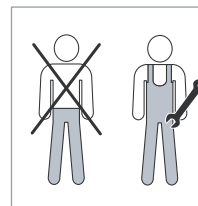

Rointe España & Portugal

Pl. Vicente Antolíns - C/ E, p. 43,
30140 Murcia
T. (ES) 968 864 363 / T. (PT) 221 200
114

Rointe United Kingdom

Catalyst House, 720 Centennial Court
Centennial Park, Elstree, Herts, WD6
3SY
T. 0203 321 5928

Rointe Ireland

20 Harcourt Street, Dublin 2, D02
H364
T. 01 553 0523

Rointe France

6 Rue Duret
75116 Paris
T. 01 73 05 70 01

Rointe Nederland

3197 LG Botlek
RT
T. 010 742 00 46