

# Gerätehaus

## Aufbauanleitung

### Anweisungen für die Montage

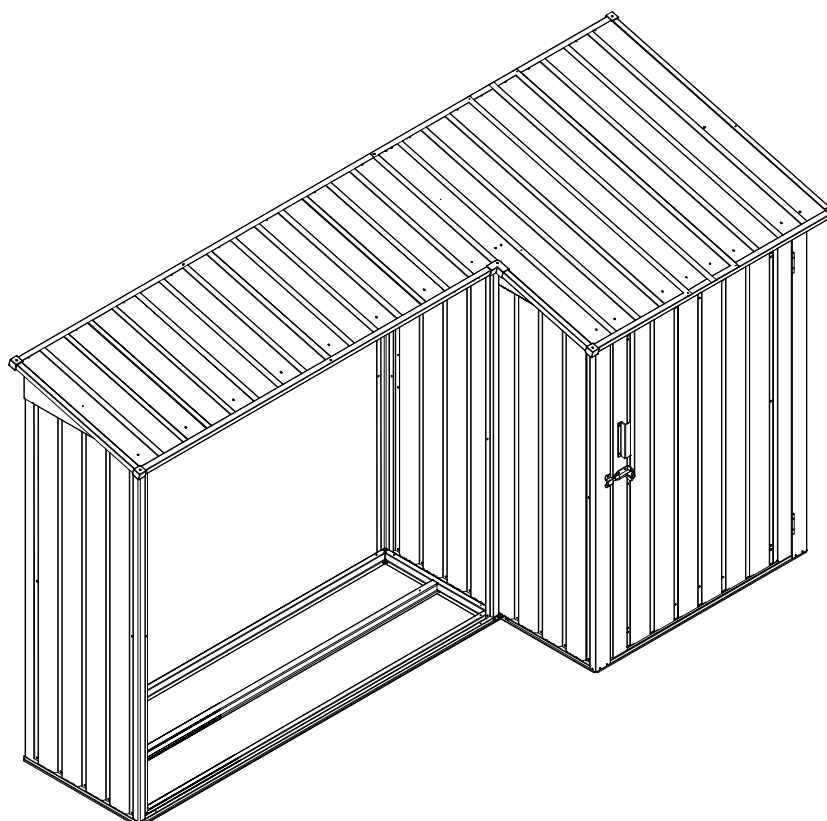







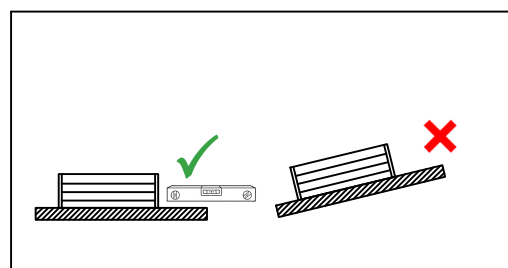
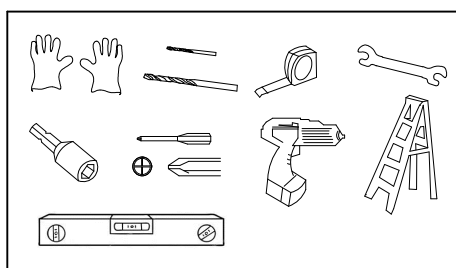
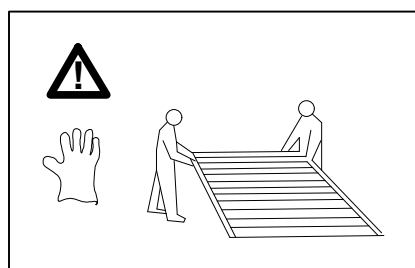





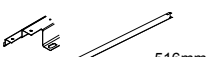
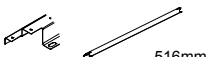

---































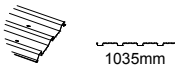
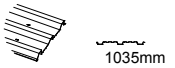
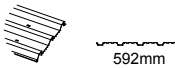
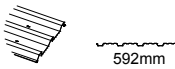
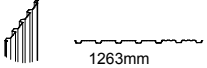



**28581668: L105xB270xH158cm**

**EAN 4024506677036**





Nr.	Teil	Anzahl
1L	 944mm	1
1R	 944mm	1
C	 944mm	1
3R	 944mm	1
3	 1620mm	2
4L	 516mm	1
4R	 516mm	1
5L	 1308mm	1
5R	 1308mm	1
8	 1390mm	2
9	 1540mm	2
10	 876mm	2
10L	 1528mm	1
10R	 1528mm	1
11	 448mm	2
12	 939mm	1
13	 939mm	1
14	 1615mm	1
15	 1621mm	1

Nr.	Teil	Anzahl
19		1
20		1
21L		1
21R		1
22L		1
22R		1
25	 592mm	1
26	 1623mm	1
27	 462mm	1
28	 1088mm	2
29	 1035mm	1
30	 1623mm	1
31	 799mm	2
33	 1264mm	1
34	 1264mm	1
P1	 1275mm	4
P2	 1390mm	1
P8	 1528mm	2
P3	 1035mm	1

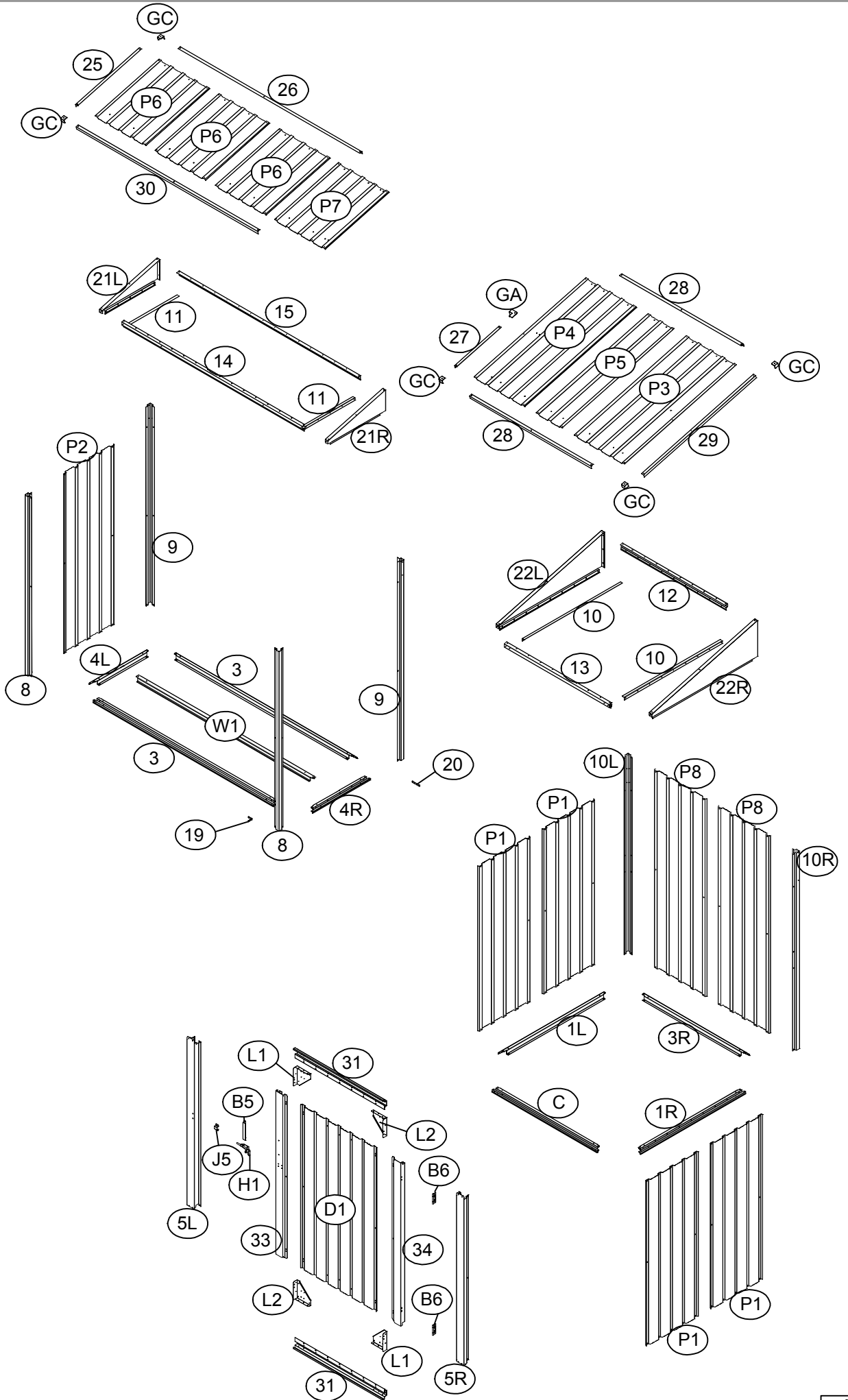
Nr.	Teil	Anzahl
P4	 1035mm	1
P5	 1035mm	1
P6	 592mm	3
P7	 592mm	1
D1	 1263mm	1
B6		2
H1&J5		1
GA		1
GC		5
F1		230
F2		30
S3		180
W1	 1580mm	1
L1		2
L2		2
B5		1
S4		120
F3		8



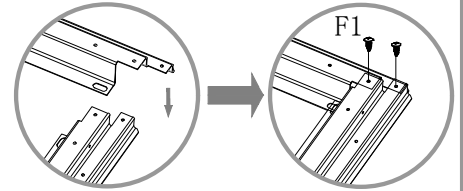
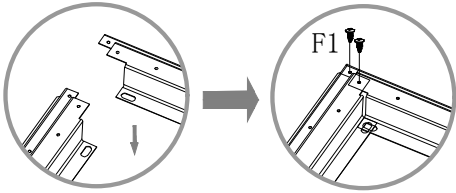
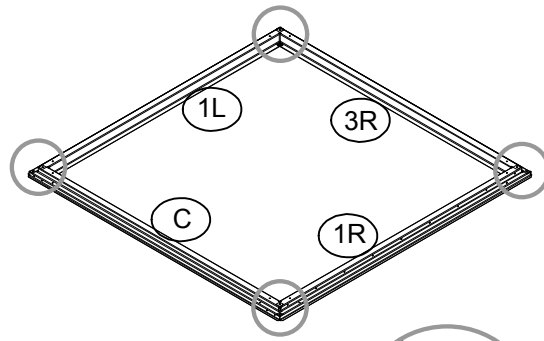

Nr.	Teil	Anzahl
1L		1
1R		1
C		1
3R		1



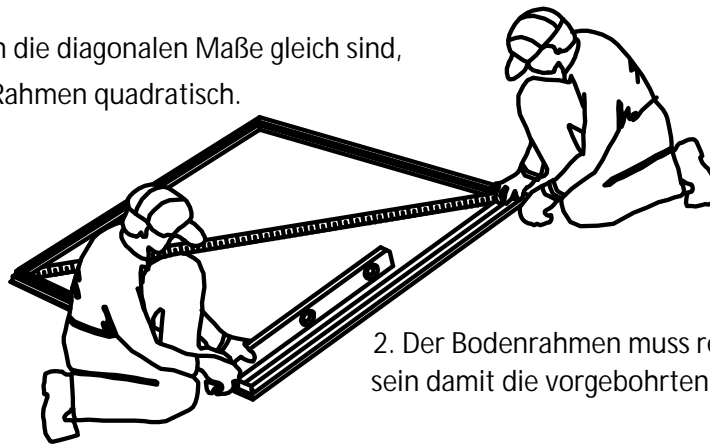

1. Wenn die diagonalen Maße gleich sind, ist der Rahmen quadratisch.



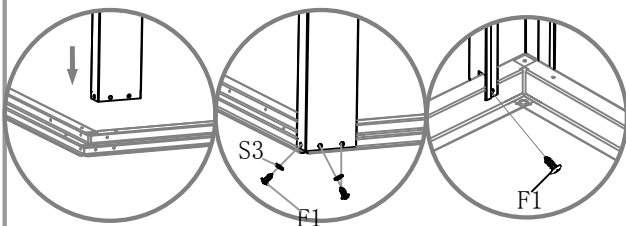
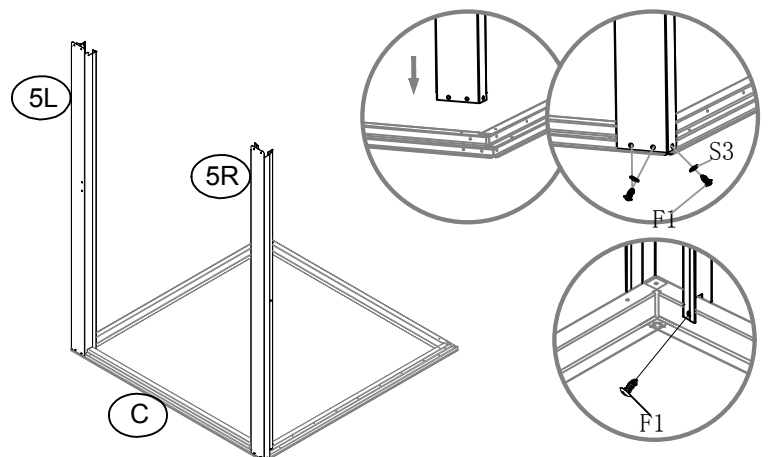

2. Der Bodenrahmen muss rechteckig und eben sein damit die vorgebohrten Löcher richtig ausgerichtet sind.

Nr.	Teil	Anzahl
5L		1
5R		1



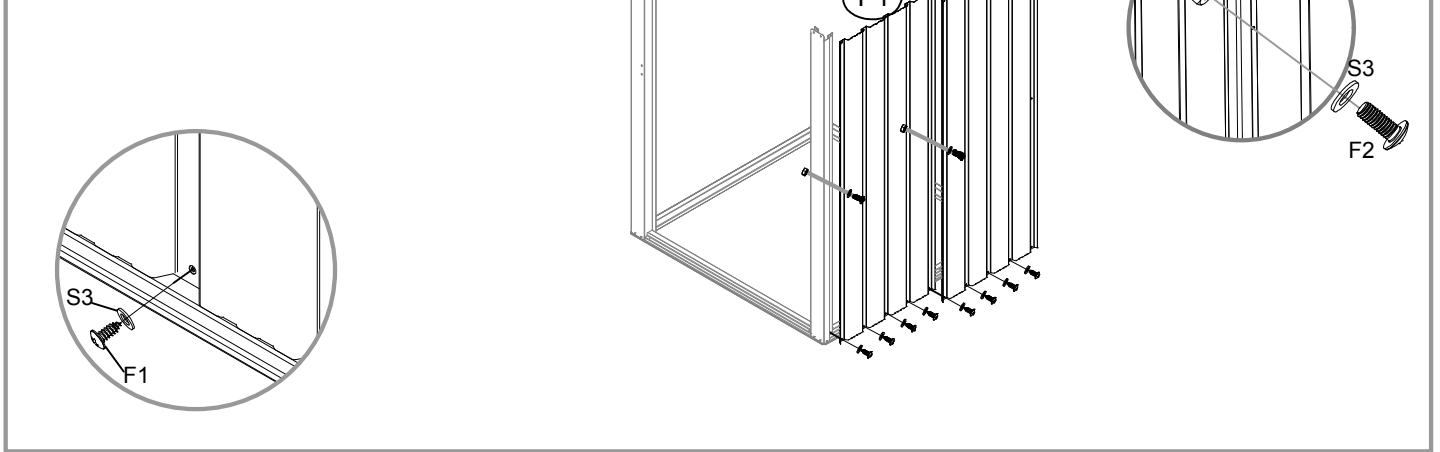

Nr.	Teil	Anzahl
P1		2

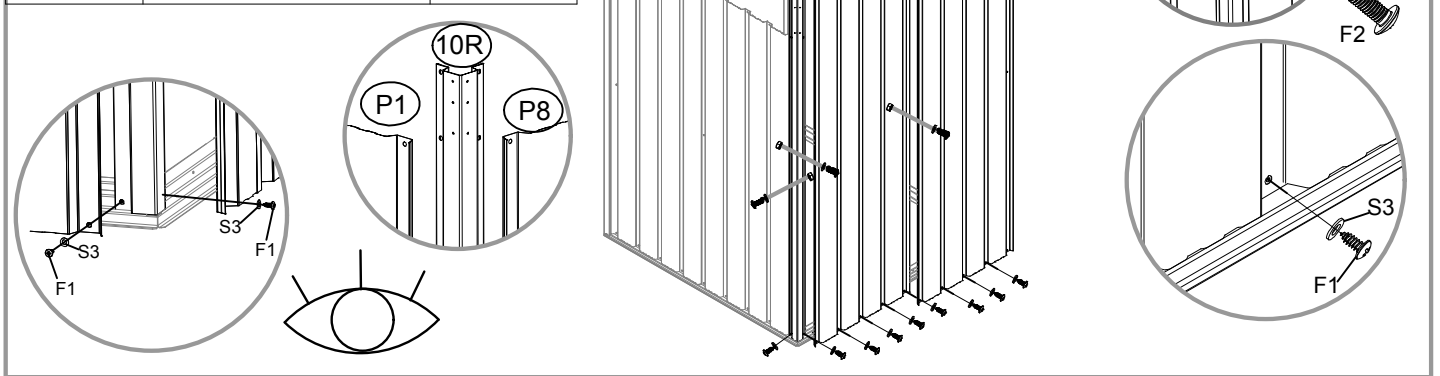

Nr.	Teil	Anzahl
10R		1
P8		2



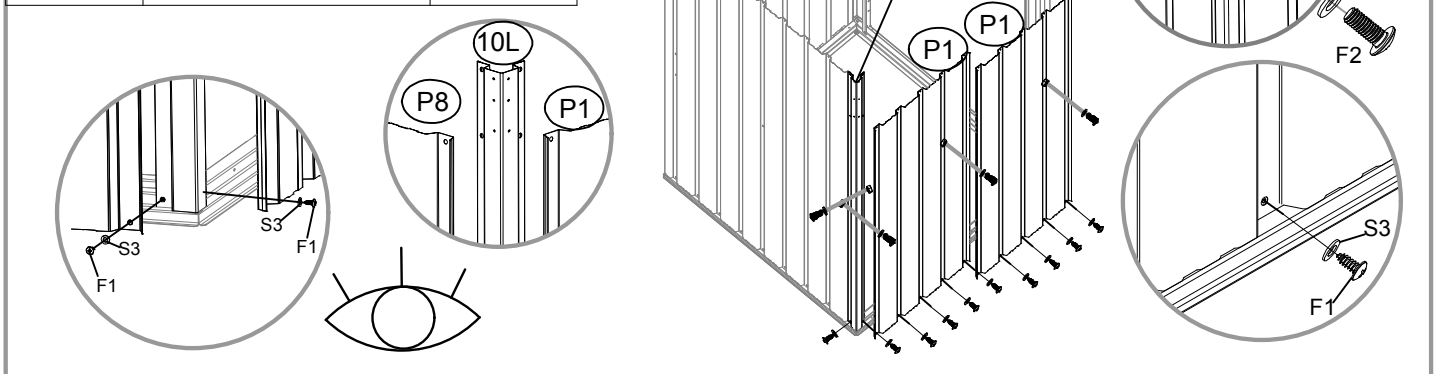

Nr.	Teil	Anzahl
10L		1
P1		2



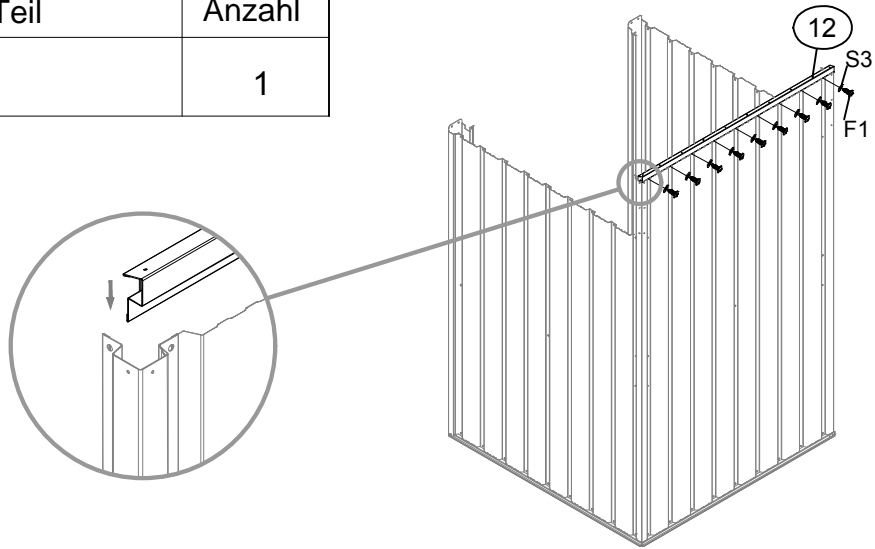

Nr.	Teil	Anzahl
12		1

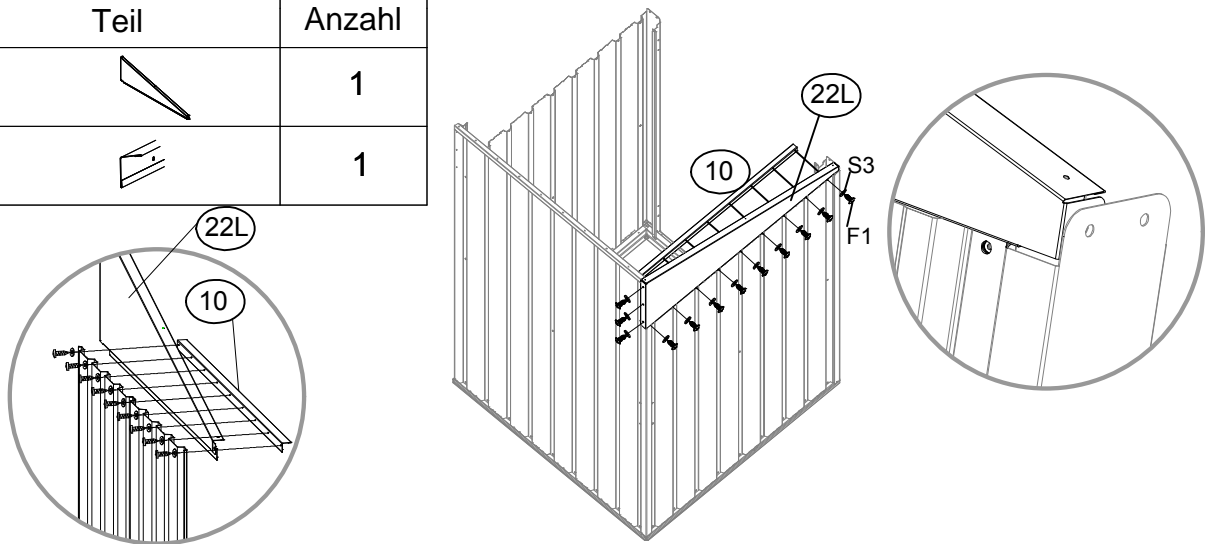

Nr.	Teil	Anzahl
22L		1
10		1



Nr.	Teil	Anzahl
22R		1
10		1

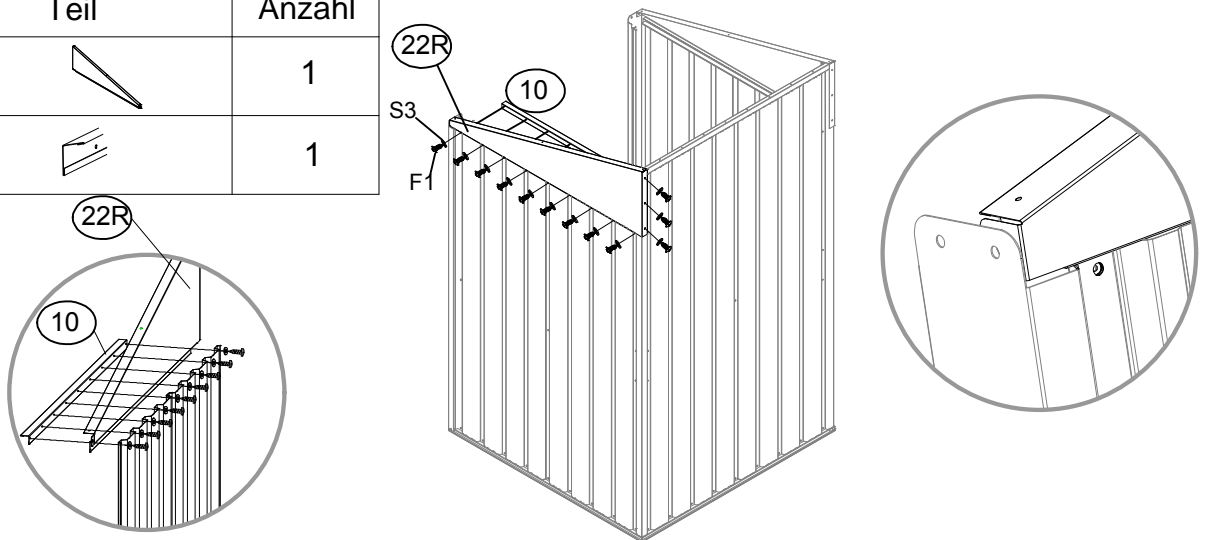

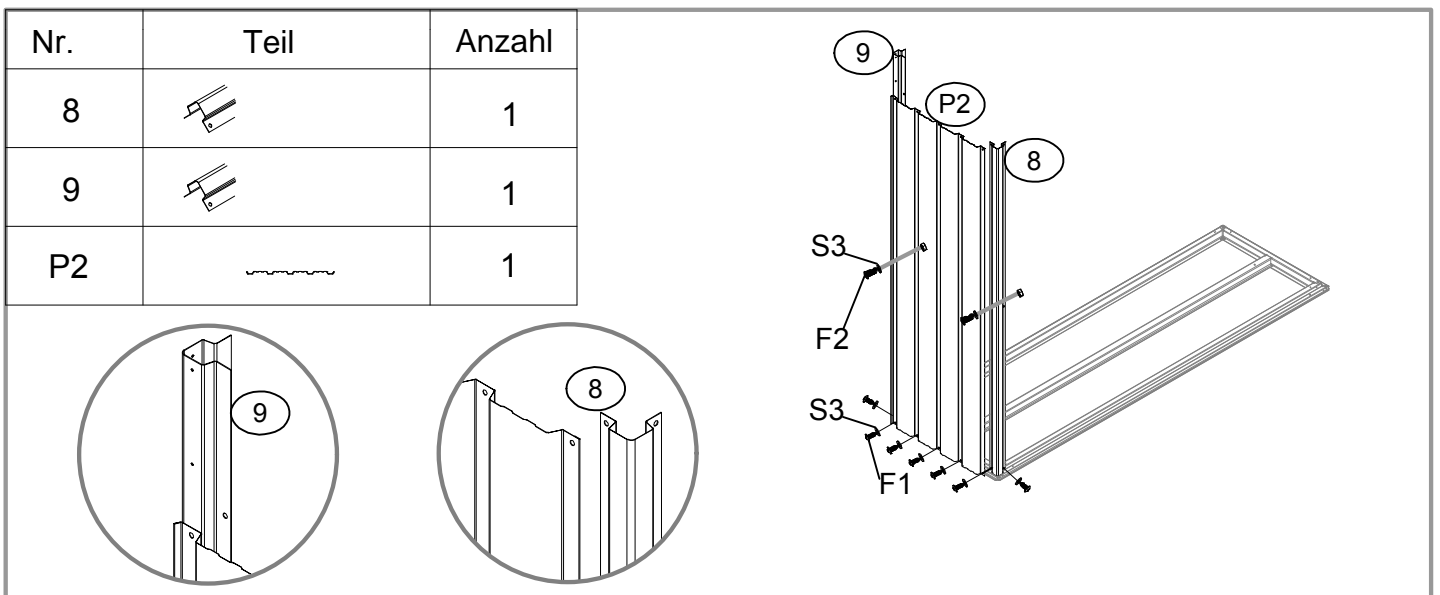
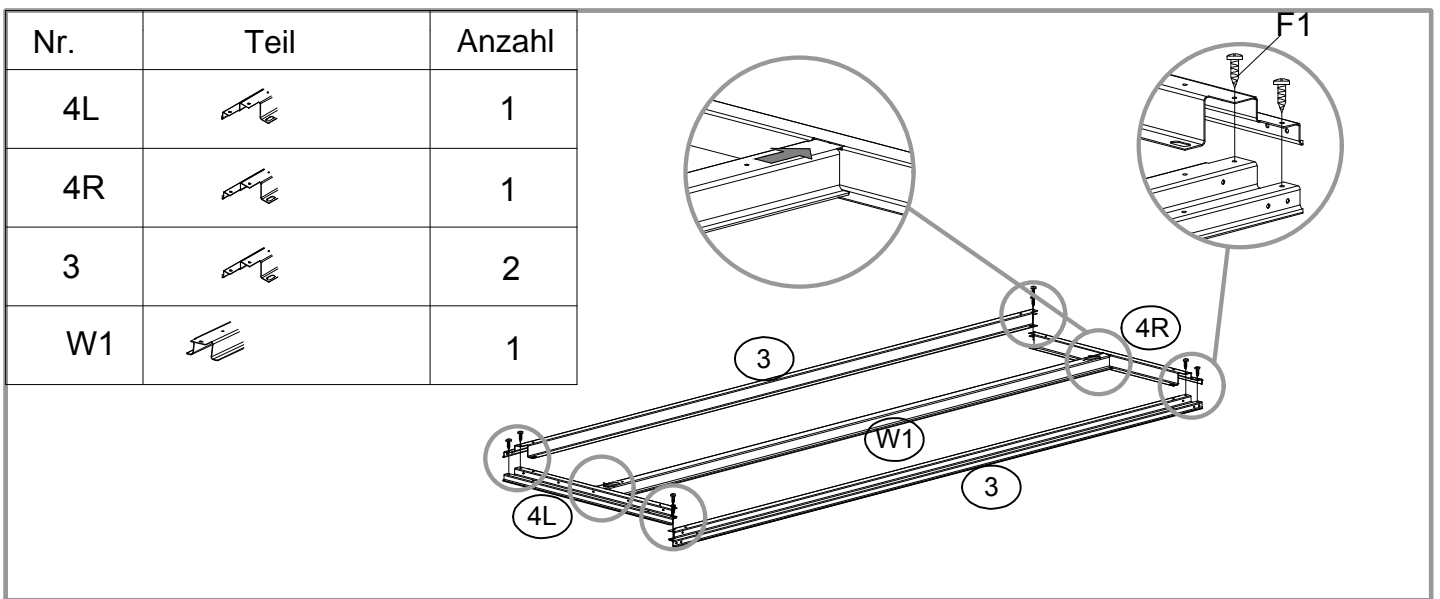
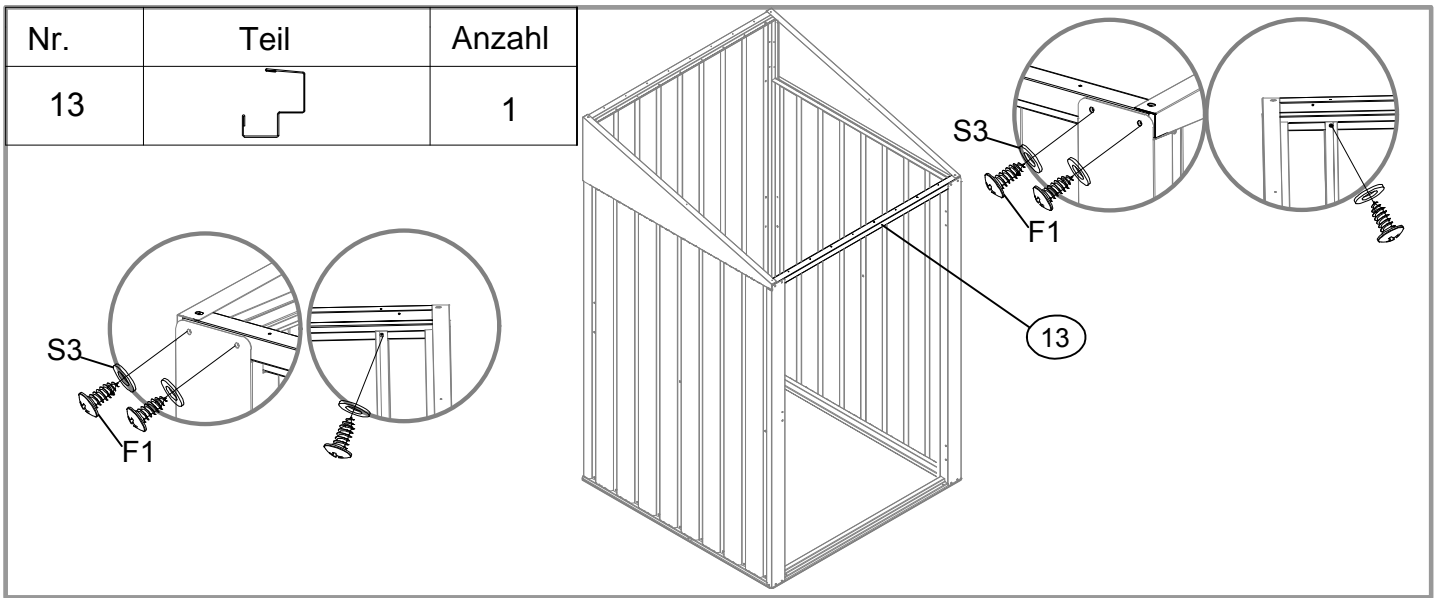



Nr.	Teil	Anzahl
8		1
9		1

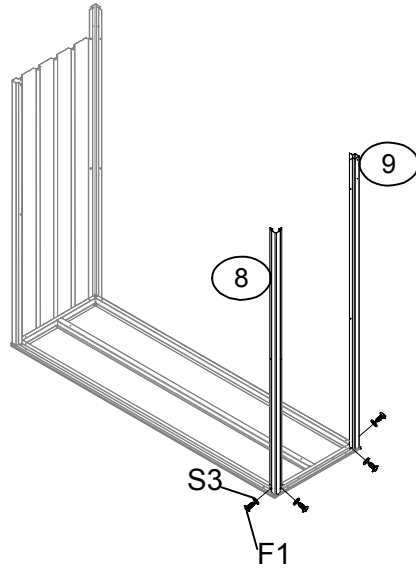

Nr.	Teil	Anzahl
21L		1
21R		1
11		2
14		1

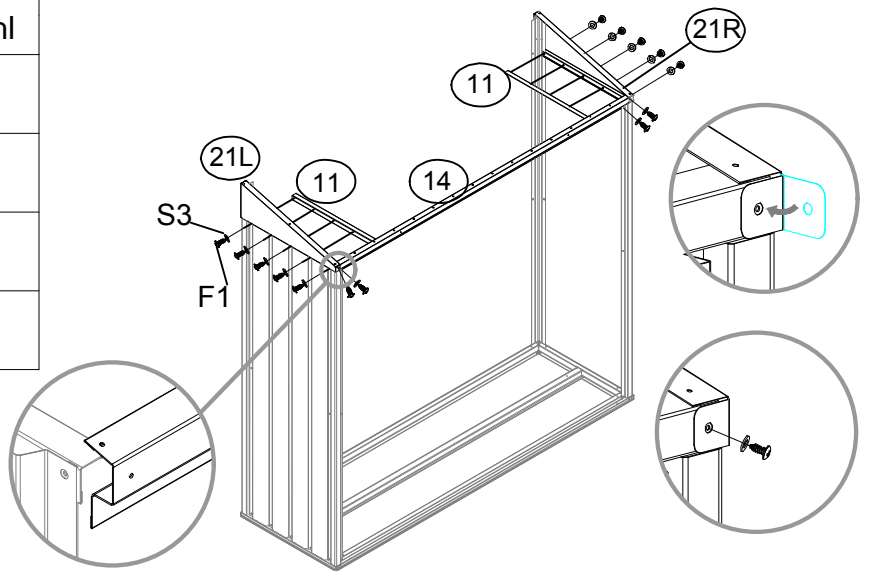

Nr.	Teil	Anzahl
15		1

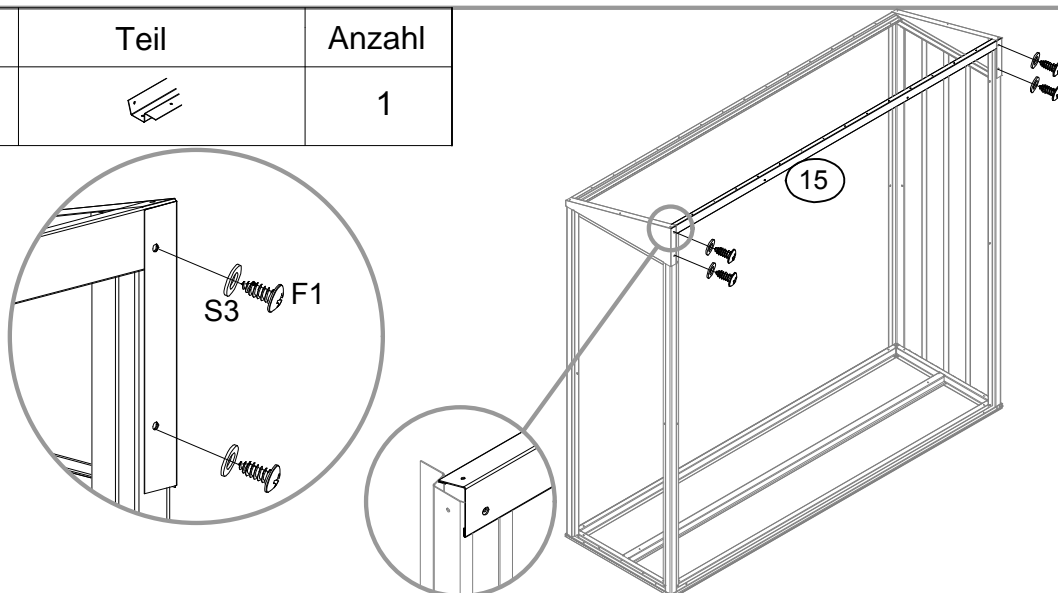

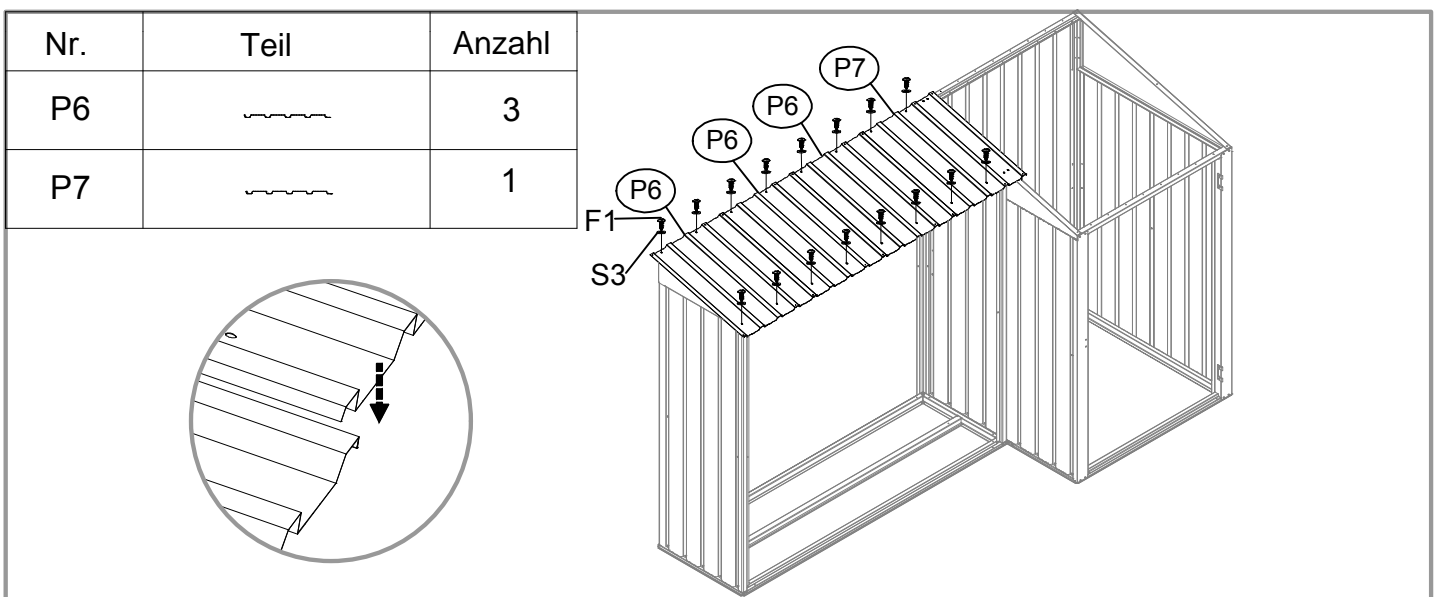
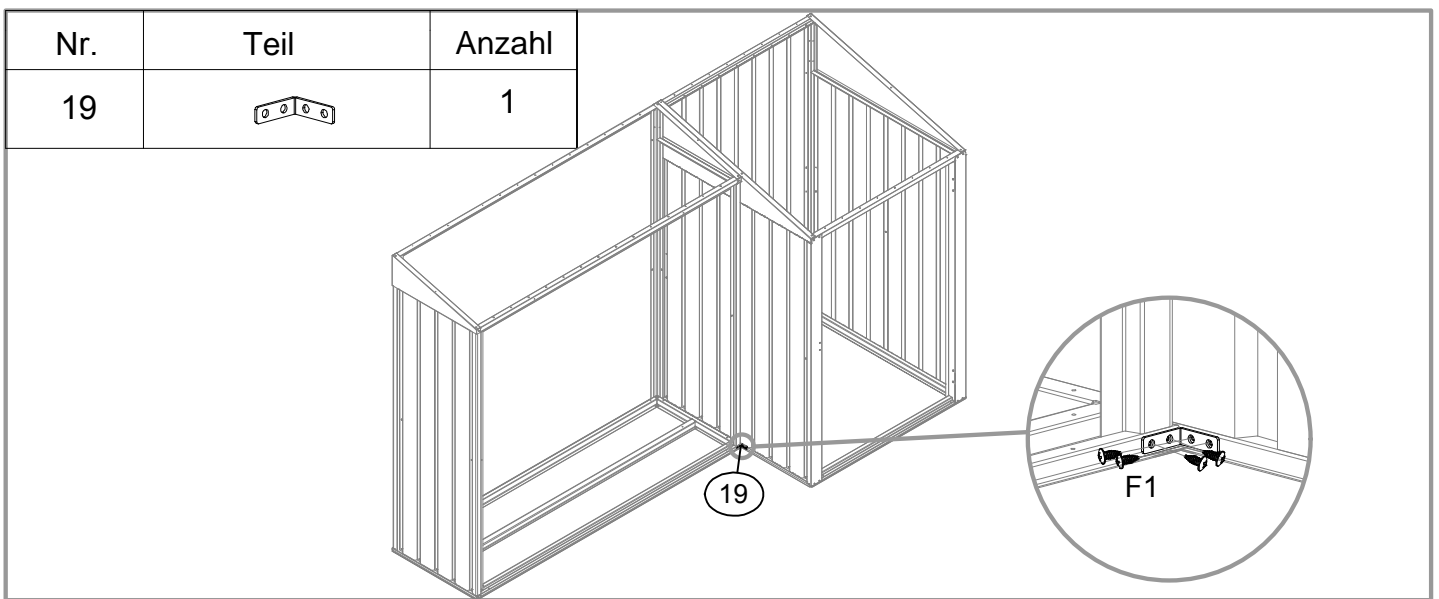
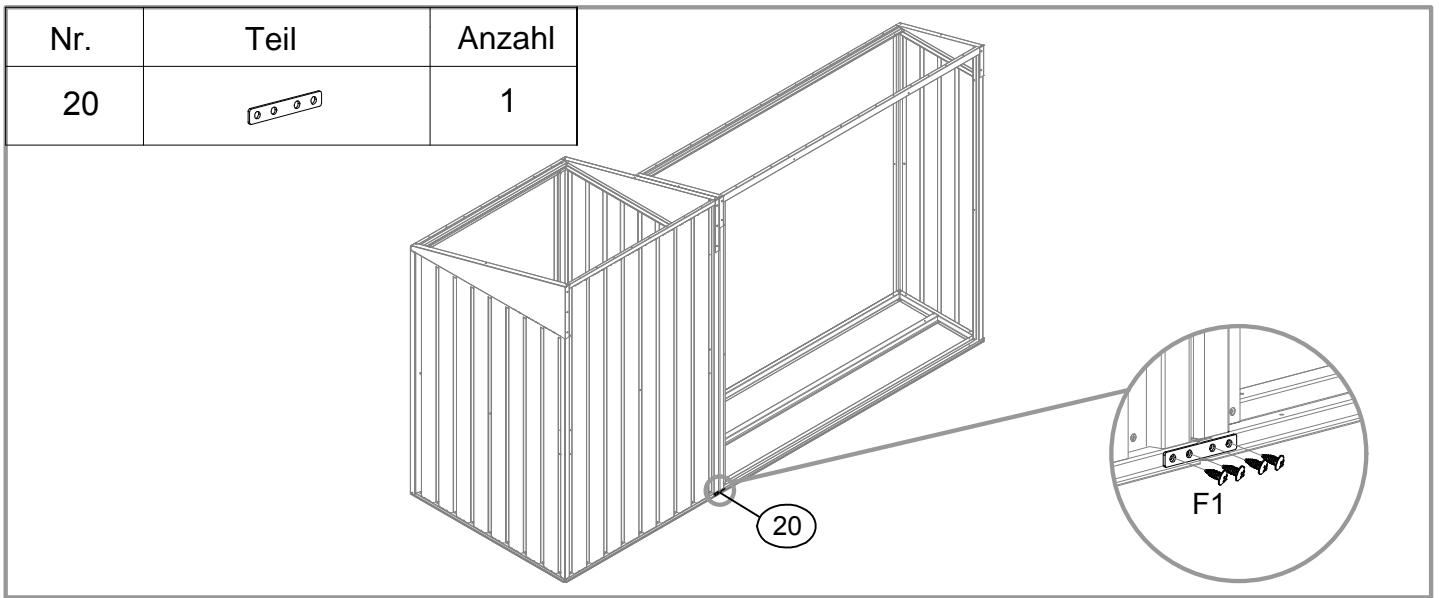

Nr.	Teil	Anzahl
P3		1
P4		1
P5		1

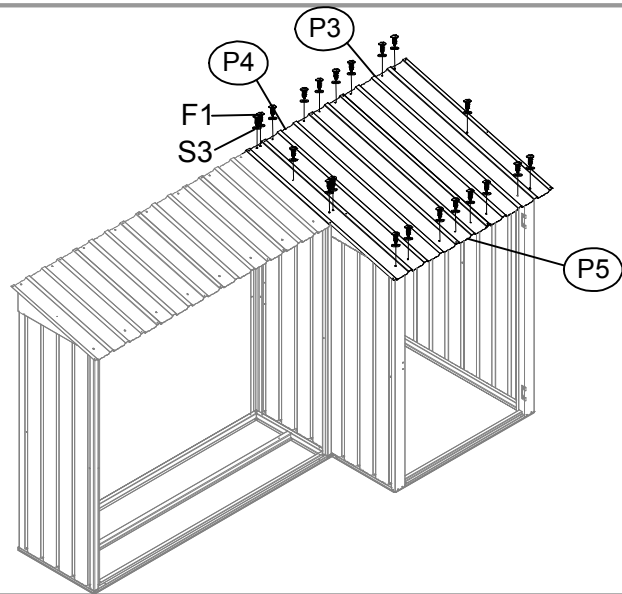
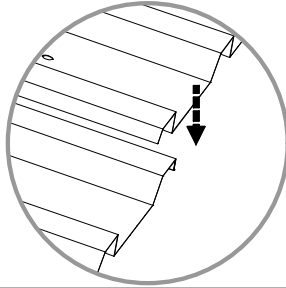

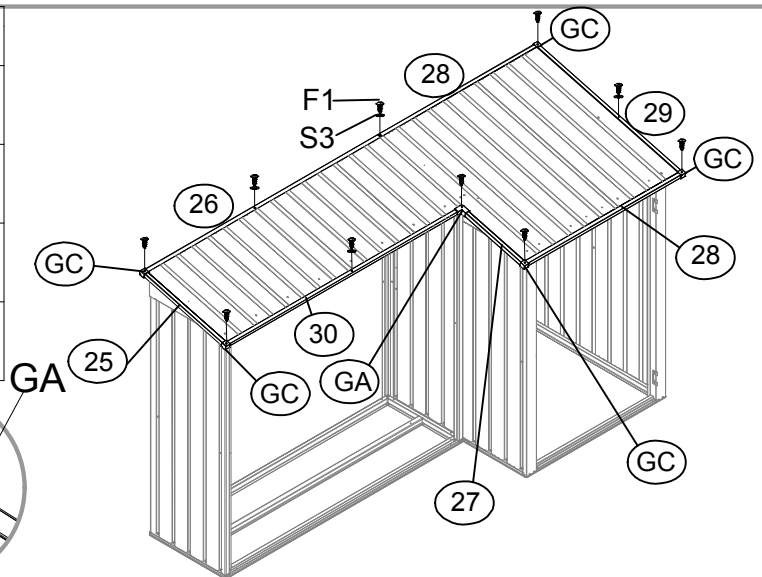
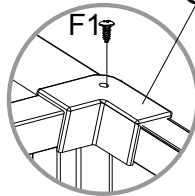
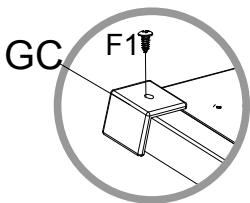

Nr.	Teil	Anzahl
25&26&27 29&30		1
28		2
GA		1
GC		5



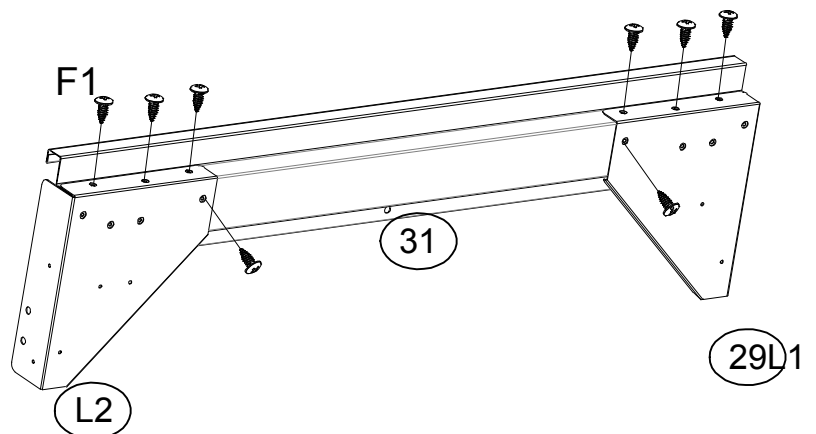

Nr.	Teil	Anzahl
L1		2
L2		2
31		2

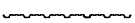
**x2**



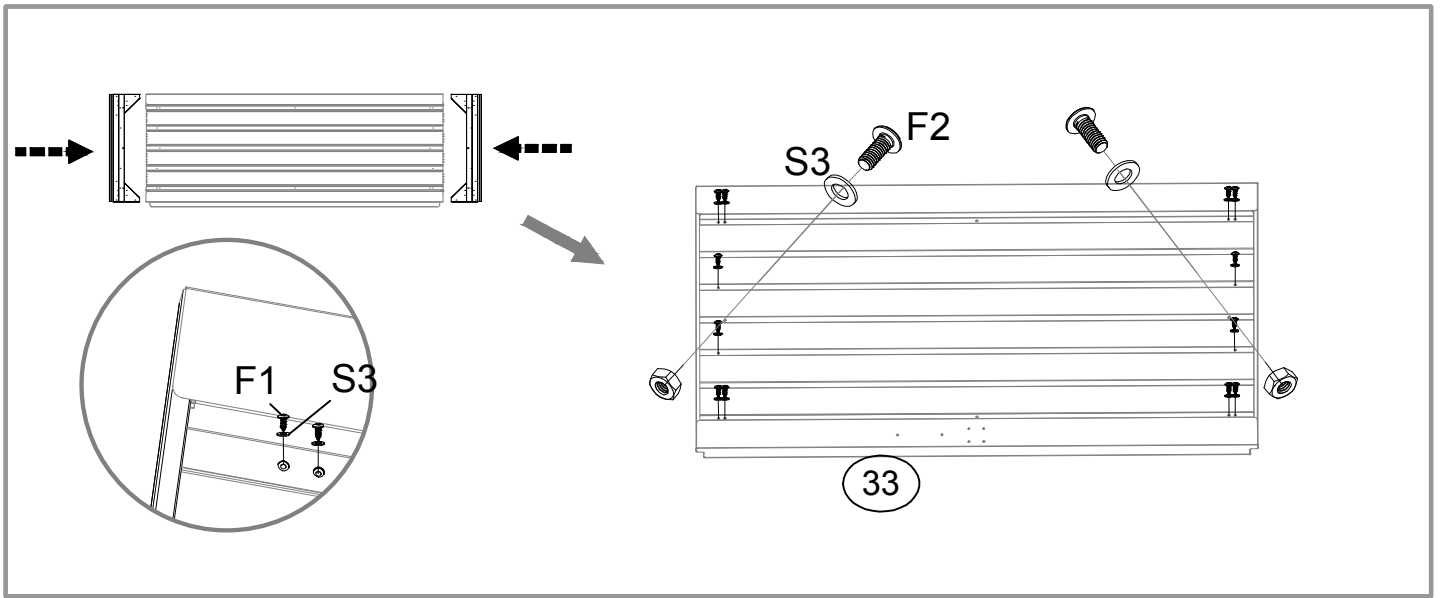
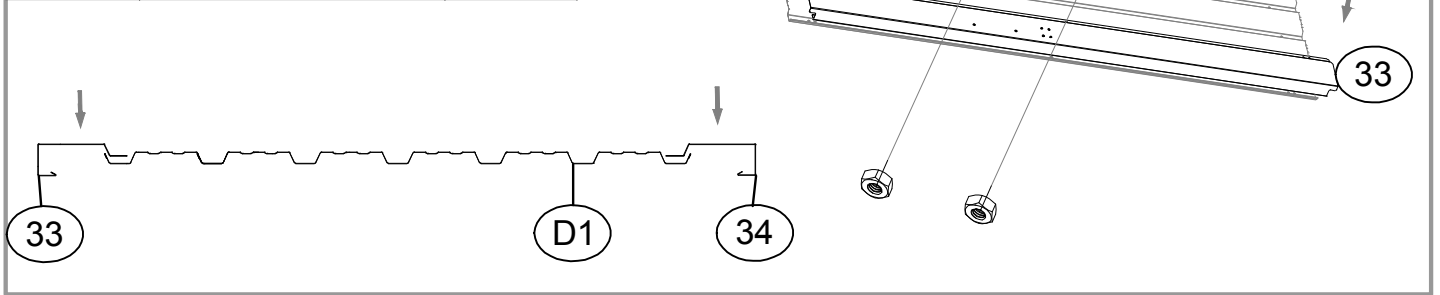

Nr.	Teil	Anzahl
D1		1
33		1
34		1

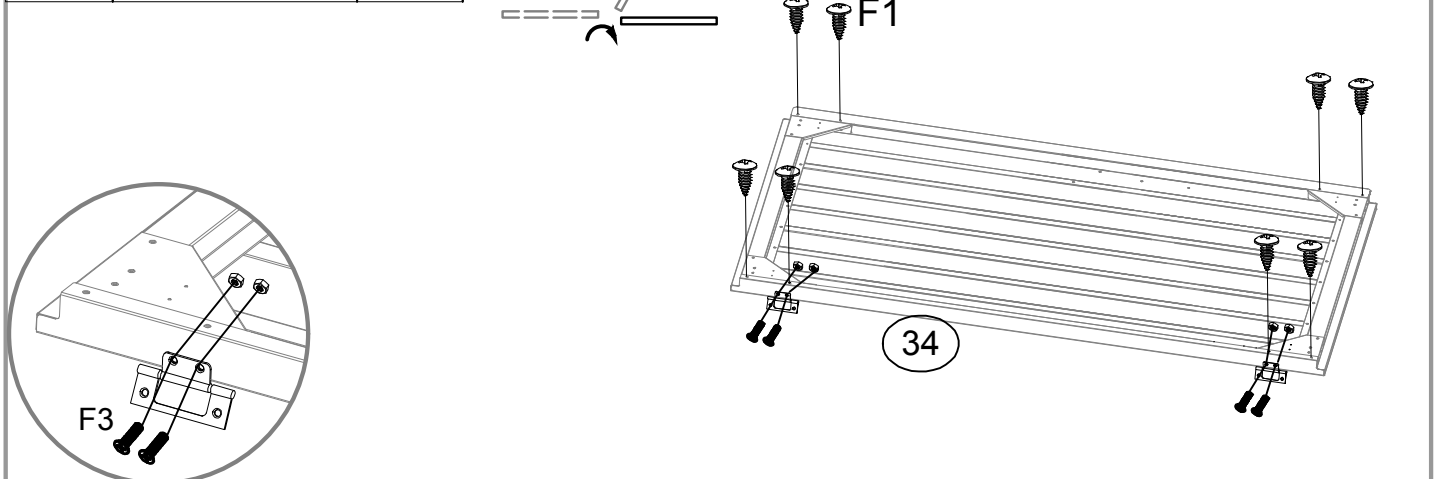

Nr.	Teil	Anzahl
B6		2

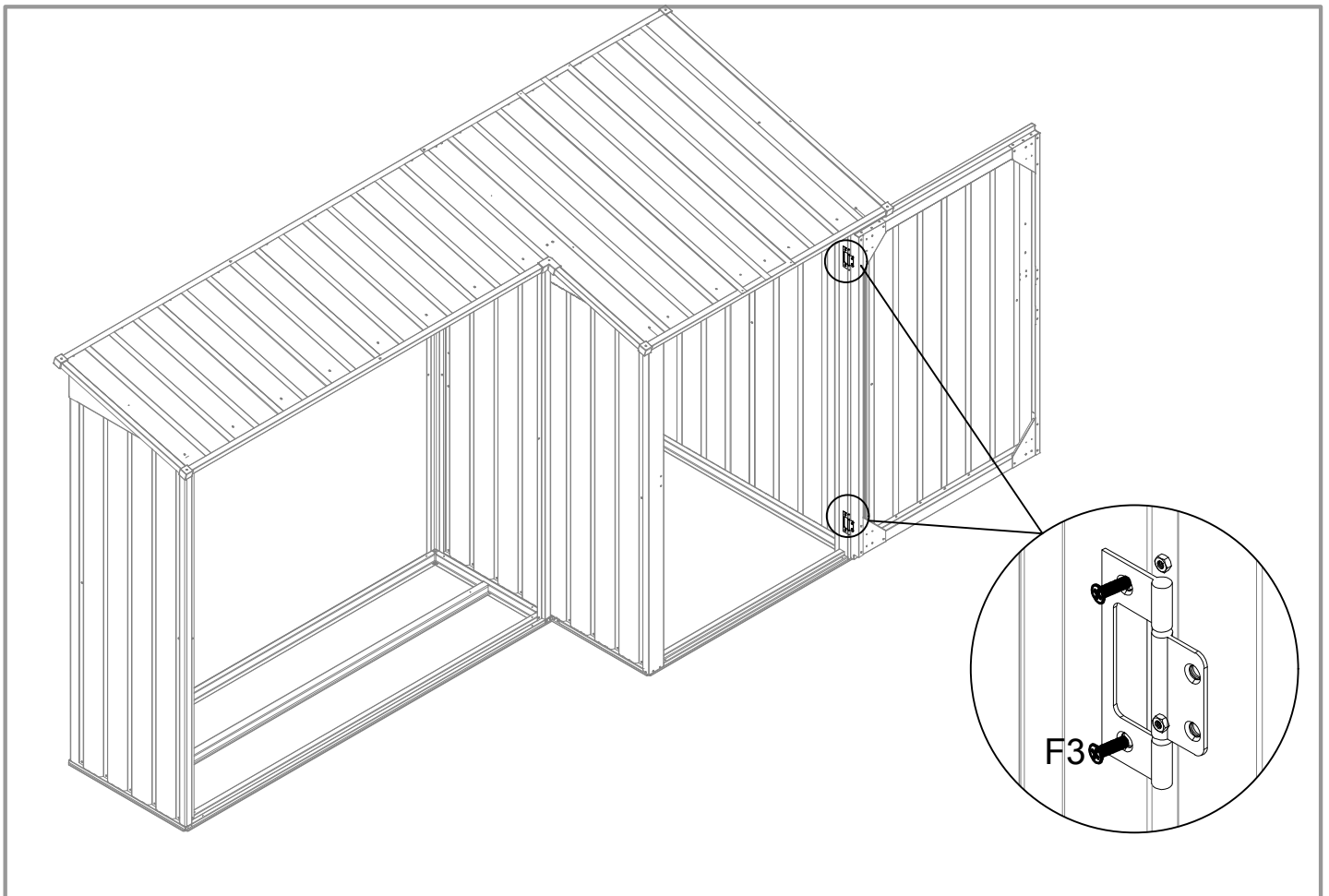



Nr.	Teil	Anzahl
H1&J5		1
B5		1

