



Radiador eléctrico digital conectado



MANUAL DE INSTRUCCIONES 02 **ES**

INSTRUCTIONS MANUAL 21 **EN**

Precauciones de seguridad

Los niños menores de 3 años deben mantenerse fuera del alcance del aparato a menos que estén continuamente supervisados. Los niños de 3 a 8 años de edad sólo deben encender y apagar el aparato cuando se haya colocado o instalado en su posición normal de uso, siempre bajo supervisión y cuando se les haya instruido sobre el uso del aparato de forma segura y comprendan los peligros que conlleva. Los niños de 3 a 8 años no deben enchufar, ajustar o limpiar el aparato ni realizar operaciones de mantenimiento. Este aparato puede ser utilizado por niños a partir de 8 años y por personas con capacidades físicas, sensoriales o mentales reducidas o con falta de experiencia y conocimientos, siempre que estén supervisados o hayan recibido instrucciones sobre el uso del aparato de forma segura y entiendan los peligros que conlleva. Los niños no deben jugar con el aparato. La limpieza y el mantenimiento no deben ser realizados por los niños sin supervisión. Los niños deben ser supervisados en todo momento para asegurarse de que no interactúan con el producto.

Este producto está lleno de una cantidad precisa de fluido térmico mineral que no necesita ningún mantenimiento. Cualquier reparación que requiera la apertura del depósito de fluido debe ser realizada únicamente por un profesional competente o por el personal del servicio posventa de Voltomat, que también debe ser notificado si se observa una fuga de líquido. Deben respetarse las normas sobre el desecho de fluidos cuando se deseché el radiador. Si el cable de alimentación está dañado, debe ser sustituido por el fabricante, su servicio postventa o personal autorizado para evitar cualquier daño. Por seguridad, este producto de calefacción no debe colocarse nunca inmediatamente debajo de una toma de corriente.



PRECAUCIÓN - Algunas partes de este producto pueden calentarse mucho y causar quemaduras. Se debe prestar especial cuidado con los niños y personas vulnerables.



NO CUBRIR - Para evitar el sobrecalentamiento, no cubra el aparato de calefacción. No se debe secar la ropa o toallas sobre la estufa ni dejar telas, revistas, botes de spray, sustancias volátiles u objetos similares a menos de 250 mm del radiador.

Introducción

Los radiadores digitales Voltomat son programables con un programador electrónico de temperatura exclusivo, fabricado con componentes de alta calidad. Los radiadores digitales Voltomat han aprobado los controles de calidad más altos, para cumplir con los requisitos de seguridad y eficiencia. Los radiadores eléctricos digitales están diseñados para una instalación fija y abajo están escritas sus funciones principales:

- Pantalla TFT
- Ajustes y programación fácil de utilizar
- Termostato electrónico preciso
- Control WIFI

Léase este manual de instrucciones y guía de instalación detenidamente para asegurar el correcto funcionamiento correcto del producto. Es muy importante que esta guía permanezca con el producto después de su instalación.

Contenido

| | |
|--|----|
| 1. Especificaciones técnicas Voltomat..... | 3 |
| 2. Instalación del sistema Voltomat..... | 5 |
| 2.1. Montaje..... | 5 |
| 2.2. Colocación de los soportes..... | 5 |
| 2.3. Plantilla de instalación de los soportes..... | 6 |
| 3. Información e instrucciones del sistema Voltomat..... | 7 |
| 3.1. Teclado..... | 7 |
| 3.2. Pantalla..... | 7 |
| 3.3. Encender y apagar..... | 8 |
| 3.4. Submenú de configuración..... | 8 |
| 3.5. Bloquear el teclado..... | 9 |
| 3.6. Seleccionar modo MANUAL, AUTOMÁTICO o PILOTO..... | 9 |
| 3.7. Funciones avanzadas del sistema Voltomat..... | 12 |
| 4. Mantenimiento y limpieza..... | 14 |
| 5. Garantía..... | 15 |
| 6. Requisitos de información de normativa ErP. Reglamento de la Comisión (EU) 2015/1188..... | 17 |

1. Especificaciones técnicas Voltomat

| MODELO | VOLTW0500 | VOLTW0750 | VOLTW1000 | VOLTW1250 | VOLTW1500 | VOLTW1750 |
|--|-----------------|-----------|-----------|-----------|-----------|-----------|
| Nº de elementos | 4 | 6 | 8 | 10 | 12 | 14 |
| DIMENSIONES | | | | | | |
| Anchura (mm) | 425 | 585 | 747 | 907 | 1069 | 1230 |
| Altura (mm) | 575 | 575 | 575 | 575 | 575 | 575 |
| Fondo (mm) | 98 | 98 | 98 | 98 | 98 | 98 |
| Fondo instalado (mm) | 120 | 120 | 120 | 120 | 120 | 120 |
| CARACTERÍSTICAS MECÁNICAS | | | | | | |
| Resistencia de acero blindado | • | • | • | • | • | • |
| Aluminio de alta pureza | • | • | • | • | • | • |
| Fluido térmico | • | • | • | • | • | • |
| Panel de control con teclado táctil | • | • | • | • | • | • |
| Cierre izquierdo | • | • | • | • | • | • |
| Peso (kg) | 8 | 12 | 16 | 20 | 24 | 28 |
| Acabado | Blanco RAL 9016 | | | | | |
| CARACTERÍSTICAS ELÉCTRICAS | | | | | | |
| Potencia nominal (W) | 500 | 750 | 1000 | 1250 | 1500 | 1750 |
| Voltaje (V) | 230 V ~ | 230 V ~ | 230 V ~ | 230 V ~ | 230 V ~ | 230 V ~ |
| Corriente (A) | 2,2 | 3,3 | 4,3 | 5,4 | 6,5 | 7,6 |
| Potencia por elemento (W/elemento) | 125 | 125 | 125 | 125 | 125 | 125 |
| INSTALACIÓN Y PROTECCIÓN | | | | | | |
| Plantilla y kit de instalación | • | • | • | • | • | • |
| Termostato de seguridad | • | • | • | • | • | • |
| Grado de protección | IP 24 | IP 24 | IP 24 | IP 24 | IP 24 | IP 24 |

2. Instalación del sistema Voltomat

2.1. Montaje

El producto funciona a través de la convección natural del aire (Figura 1). Para conseguir un perfecto rendimiento y una homogénea distribución del calor, la parte inferior del radiador, una vez instalado en la pared, deberá quedar a una distancia mínima del suelo de 10 a 12 cm, y a un máximo de 30 cm. Lateral y superiormente, deberá quedar a una distancia mínima de 10 a 12 cm de cualquier pared u obra, para que éste caliente adecuadamente (Figura 2).

Figura 1



Figura 2



2.2. Colocación de los soportes

Dentro del embalaje, encontrará un kit de instalación. Véase las instrucciones abajo:

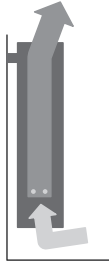
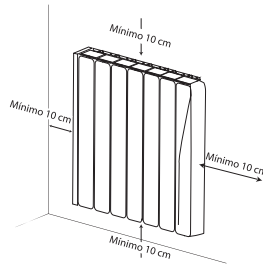
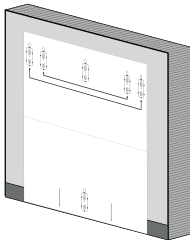
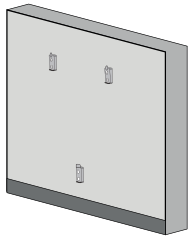
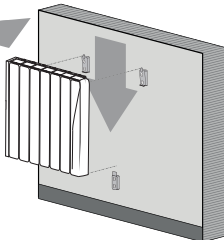

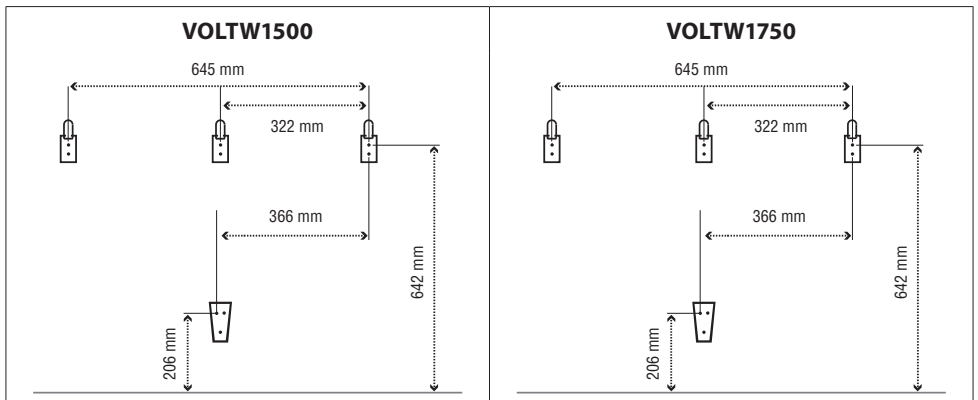
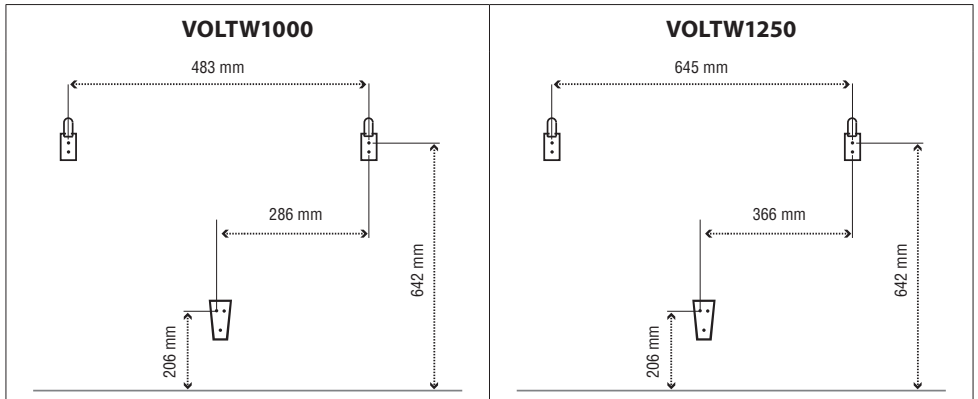
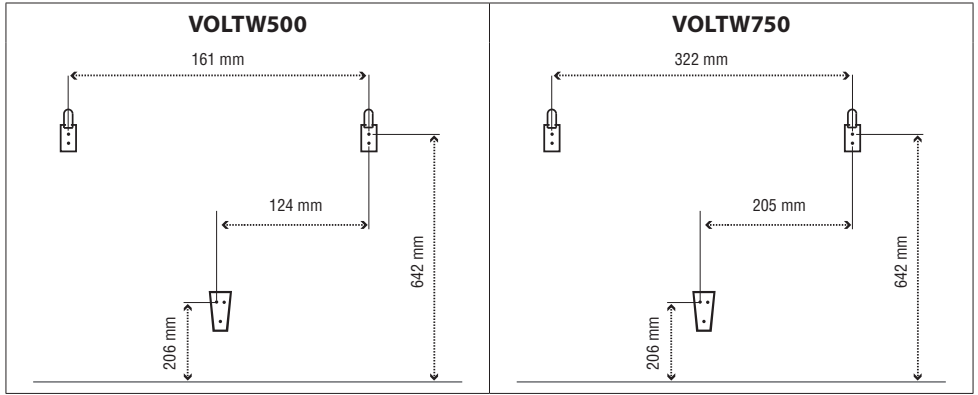

| | | |
|--|--|---|
|  |  |  |
| <ol style="list-style-type: none"> 1. Seleccionar el lugar adecuado de la pared. 2. Colocar la plantilla en la pared, haciendo pequeñas marcas en los lugares donde van situados los agujeros. | <ol style="list-style-type: none"> 3. Retirar la plantilla y hacer los agujeros. 4. Colocar los soportes en la pared mediante los tacos y tornillos. | <ol style="list-style-type: none"> 5. Comprobar la posición del soporte inferior. 6. Alinear el producto con los soportes superiores. 7. Colgar el radiador en los soportes. |

2.3. Plantilla de instalación de soportes



3. Información e instrucciones del sistema Voltomat





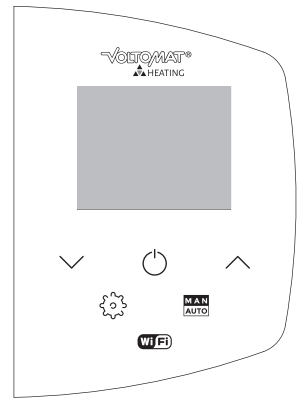

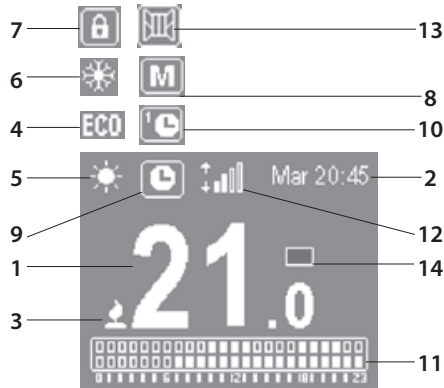

3.1. Teclado







| | |
|---|---|
|  | Ajustes/ Retroceder |
|  | Encender / Apagar / Confirmar |
|  | Disminuir temperatura / Mover hacia abajo |
|  | Aumentar temperatura / Mover hacia arriba |
|  | Función manual - automático |





3.2. Pantalla











| | | |
|---|--------------------------|---|
| 1 | Temperatura seleccionada |  |
| 2 | Hora y Día actual |  |
| 3 | Resistencia encendida |  |
| 4 | Modo económico |  |
| 5 | Modo confort |  |
| 6 | Modo anti-hielo |  |
| 7 | Bloqueo de teclado |  |
| 8 | Modo Manual |  |





| | | |
|----|---------------------------------|--|
| 9 | Modo Auto |  |
| 10 | Modo Pre-programación |  |
| 11 | Programación horaria |  |
| 12 | Indicador de conexión de red |  |
| 13 | Indicador ventanas abiertas |  |
| 14 | Indicador de consumo de energía |  |

3.3. Encender y apagar

Para encender el producto pulse al botón  una vez. Para apagar el producto, pulse de nuevo al botón .

Cuando enciende el producto por primera vez le obligará a establecer la fecha y la hora. Utilice los botones   para seleccionar la hora correcta y pulse al botón  para confirmar. A continuación, utilice los botones   para seleccionar los minutos correctos y pulse al botón  para confirmar. Después utilice los botones   para seleccionar el día correcto y pulse al botón  para confirmar.









3.4. Submenú de configuración

Pulse al botón  para acceder al menú de configuración. Después utilice los botones   para llegar a la opción **AJUSTES**. Pulse al botón  para entrar en el submenú **AJUSTES**.



3.4.1. Ajustar el día y la hora

Para ajustar el día o la hora seleccione la opción **RELOJ**.



Utilice los botones   para seleccionar la hora correcta y pulse al botón  para confirmar. A continuación, utilice los botones   para seleccionar los minutos correctos y pulse al botón  para confirmar. Después utilice los botones   para seleccionar el día correcto y pulse al botón  para confirmar.



3.4.2. Ajustar luminosidad

Esta función permite cambiar el brillo de la pantalla para los modos **ACTIVO** y **STAND-BY**.

Para ajustar el brillo, seleccione la opción **BACKLIGHT**.

Con los botones   podemos aumentar o reducir el valor de iluminación. Con el botón  confirmamos el valor.

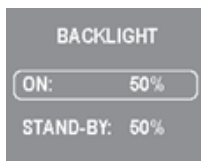

3.4.3. Idioma

Esta función nos permite seleccionar el idioma preferido para comunicarnos con el producto.

Para cambiar el idioma del producto, seleccione la opción **IDIOMA**.





3.4.4. Modo AUTOMÁTICO



Esta opción muestra la versión de software y la fecha de lanzamiento.

Para visualizar estos datos, seleccione la opción **FIRMWARE**.



3.5. Bloquear el teclado

Para bloquear el teclado, mantenga pulsado los botones   a la misma vez durante 3 segundos. Le aparecerá un icono  en la parte derecha de la pantalla.

Para desbloquear el teclado, mantenga pulsado los botones   a la misma vez durante 3 segundos. El icono desaparecerá de la pantalla.

3.6. Seleccionar modo MANUAL, AUTOMÁTICO O PILOTO*(*Solo disponible bajo demanda)

Para seleccionar modo **MANUAL**, **AUTO**, **PRE-PROGRAMACION** O **PILOTO** acceda al menú de programación pulsando el botón .



Desde **MODO** seleccionaremos entre modo **MANUAL** o **AUTOMATICO**.

Desde **PRE-PROGRAMACIONES** seleccionaremos una de las 4 programaciones por defecto.

Desde **PROGRAMACION USUARIO** iniciamos la edición de una programación.

Desde **HILO PILOTO** activamos el control externo de nuestro producto.

(*Solo disponible bajo demanda).

3.6.1. Modo MANUAL



Cuando se selecciona el modo **MANUAL**, la temperatura, el icono de modo **MANUAL**, el icono de **CONFORT/ECO/ANTI-HIELO**, el indicador de consumo y la hora y el día de la semana se mostrarán en la pantalla.



En modo **MANUAL** puede elegir una temperatura y el icono correspondiente se mostrará en la pantalla de acuerdo con los rangos establecidos en la tabla:

| | |
|------------|---------------|
| CONFORT | 21-30 °C |
| ECO | 7.5 - 20.5 °C |
| ANTI-HIELO | 7 °C |

Para ajustar la temperatura:

Utilice los botones   para aumentar o disminuir la temperatura respectivamente. Cuando elige una de las temperaturas de la tabla de arriba, el icono correspondiente aparecerá en la pantalla.

Cuando la temperatura de la habitación es inferior a la temperatura marcada en el radiador, el producto mostrará un símbolo  en la parte superior izquierda de la pantalla.

3.6.2. Modo AUTOMÁTICO

Cuando se selecciona el modo automático, se activará la programación ya establecida en el producto. Puede elegir entre las cuatro programaciones pre-instaladas en su producto Voltomat:

Pre-programaciones:

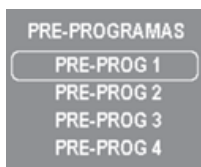

| PRE-PROGRAMACIÓN 1 | | | | | | | | | | | | | | | | | | | | | | | | |
|--------------------|---|---|---|---|---|---|---|---|---|---|----|----|----|----|----|----|----|----|----|----|----|----|----|----|
| | 0 | 1 | 2 | 3 | 4 | 5 | 6 | 7 | 8 | 9 | 10 | 11 | 12 | 13 | 14 | 15 | 16 | 17 | 18 | 19 | 20 | 21 | 22 | 23 |
| L-V | | | | | | | ■ | ■ | ■ | ■ | ■ | ■ | ■ | ■ | ■ | ■ | ■ | ■ | ■ | ■ | ■ | ■ | ■ | |
| S-B | | | | | | | | ■ | ■ | ■ | ■ | ■ | ■ | ■ | ■ | ■ | ■ | ■ | ■ | ■ | ■ | ■ | ■ | |













| PRE-PROGRAMACIÓN 2 | | | | | | | | | | | | | | | | | | | | | | | | |
|--------------------|---|---|---|---|---|---|---|---|---|---|----|----|----|----|----|----|----|----|----|----|----|----|----|----|
| | 0 | 1 | 2 | 3 | 4 | 5 | 6 | 7 | 8 | 9 | 10 | 11 | 12 | 13 | 14 | 15 | 16 | 17 | 18 | 19 | 20 | 21 | 22 | 23 |
| L-V | | | | | | | ■ | ■ | ■ | ■ | ■ | ■ | ■ | ■ | ■ | ■ | ■ | ■ | ■ | ■ | ■ | ■ | ■ | ■ |
| S-B | | | | | | | | ■ | ■ | ■ | ■ | ■ | ■ | ■ | ■ | ■ | ■ | ■ | ■ | ■ | ■ | ■ | ■ | ■ |











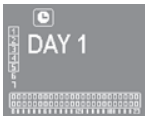

| PRE-PROGRAMACIÓN 3 | | | | | | | | | | | | | | | | | | | | | | | | |
|--------------------|---|---|---|---|---|---|---|---|---|---|----|----|----|----|----|----|----|----|----|----|----|----|----|----|
| | 0 | 1 | 2 | 3 | 4 | 5 | 6 | 7 | 8 | 9 | 10 | 11 | 12 | 13 | 14 | 15 | 16 | 17 | 18 | 19 | 20 | 21 | 22 | 23 |
| L-D | ■ | ■ | ■ | ■ | ■ | ■ | ■ | ■ | ■ | ■ | ■ | ■ | ■ | ■ | ■ | ■ | ■ | ■ | ■ | ■ | ■ | ■ | ■ | ■ |

| PRE-PROGRAMACIÓN 4 | | | | | | | | | | | | | | | | | | | | | | | | |
|--------------------|---|---|---|---|---|---|---|---|---|---|----|----|----|----|----|----|----|----|----|----|----|----|----|----|
| | 0 | 1 | 2 | 3 | 4 | 5 | 6 | 7 | 8 | 9 | 10 | 11 | 12 | 13 | 14 | 15 | 16 | 17 | 18 | 19 | 20 | 21 | 22 | 23 |
| L-V | | | | | | | | ■ | ■ | ■ | ■ | ■ | ■ | ■ | ■ | ■ | ■ | ■ | ■ | ■ | ■ | ■ | ■ | ■ |
| S-B | | | | | | | | ■ | ■ | ■ | ■ | ■ | ■ | ■ | ■ | ■ | ■ | ■ | ■ | ■ | ■ | ■ | ■ | ■ |

| | | | | | |
|---------|---|-----|---|-----|---|
| CONFORT | ■ | ECO | ■ | OFF | ■ |
|---------|---|-----|---|-----|---|





Si queremos realizar una programación propia debemos hacerlo de la siguiente manera:

| PASO 1 | |
|---|--|
| <p>1. Selección de la temperatura CONFORT:</p> <p>Rango de selección: 19 – 30°C</p> <p>Mediante las teclas  y  seleccionaremos la temperatura.</p> <p>Con  confirmaremos.</p> <p>2. Selección de la temperatura ECO:</p> <p>Rango de selección: 7.5 – 18.5°C</p> <p>Mediante las teclas  y  seleccionaremos la temperatura.</p> <p>Con  confirmaremos.</p> <p>3. Selección entre el modo ANTIFROST u OFF:</p> <p>Rango de selección: 7°C – OFF</p> <p>Mediante las teclas  y  seleccionaremos la opción. Con  confirmaremos.</p> |    |

| | |
|--|---|
| <p>PASO 2</p> <p>1. Selección de los días a programar:</p> <p>Debemos seleccionar los días marcando mediante pulsación corta sobre la tecla .</p> <p>Los días marcados deberán quedar remarcados mediante un cuadro mediante las teclas  y  nos desplazaremos entre los días.</p> <p>Tras pulsar  estando en el día 7 pasamos al siguiente paso.</p> |  |
| <p>PASO 3</p> <p>1. Selección del modo en cada hora:</p> <p>Mediante la tecla  intercambiaremos entre los modos ECO, CONFORT, FROST/OFF. Y con las teclas  y  avanzaremos de hora.</p> <p>a. En la parte superior derecha se indicará la hora que estamos programando.</p> <p>b. En el lateral izquierdo nos muestra los días seleccionados.</p> <p>c. La barra de programación nos indicará.</p> <p>I. Modo CONFORT: dos cuadrados sombreados </p> <p>II. Modo ECO: Cuadrado inferior relleno </p> <p>III. Modo FROST/OFF: dos cuadrados vacíos </p> <p>Tras pulsar  estando en la hora 23 finalizará la programación.</p> |  |





3.7. Funciones avanzadas del sistema Voltomat

El sistema Voltomat incluye cuatro funciones avanzadas – véase abajo-.

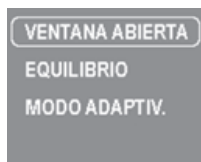
Para activar o desactivar uno de las funciones de abajo, pulse el botón  para acceder al menú de los ajustes. Utilice los botones   para pasar por el menú hasta seleccionar el submenú **ENERGIA**. Pulse el botón  para acceder al submenú. Dentro de este submenú nos aparecen las opciones:

1. Ventanas abiertas
2. Equilibrio
3. Modo adaptativo



Accediendo a cada una de ellas podemos activar o desactivar su funcionamiento. Una vez seleccionado, pulse al botón  y utilice los botones   para activar o desactivar la función. Pulse el botón  una vez más para confirmar la opción.

3.7.1. Función VENTANAS ABIERTAS

El sistema Voltomat tiene la función de **VENTANAS ABIERTAS**  activada para empezar. Esta función se activa cuando la sonda de temperatura detecta que ha habido una disminución de la temperatura de 4°C en un periodo de 30 minutos. El modo **VENTANAS ABIERTAS** se activa durante dos horas. Cuando el modo **VENTANAS ABIERTAS** está activo, el radiador estará en modo **ANTI-HIELO** a 7°C.

3.7.2. Función EQUILIBRIO

El submenú equilibrio hace que le producto trabaje en modo Manual con una temperatura constante de 19°C. Una vez seleccionado, el producto vuelve a la pantalla principal, con la temperatura establecida en 19°C y el icono función **MANUAL** activado.

3.7.3. Función MODO ADAPTATIVO

Esta función avanzada predice el comportamiento del producto para conseguir que la temperatura ambiente al inicio de la hora seleccionada sea igual a la temperatura de consigna en la hora exacta que desea el usuario.

Solo está activo durante el modo de programación.

3.8. Emparejamiento WIFI

El submenú WIFI nos permite activar/desactivar la conexión y realizar un emparejamiento con un dispositivo.

Pulsando sobre la opción EMPAREJAR el producto creará una red propia a la cual nos conectaremos para la correcta configuración del mismo.

En la siguiente pantalla aparecerá los datos de la red creada (NET) y la contraseña (PIN).



Cuando el dispositivo se conecte a la red del radiador nos aparecerá el siguiente display:



Cuando el producto haya recibido la configuración desde el dispositivo móvil y va a comenzar a procesarla muestra la siguiente pantalla:



Esta pantalla indica al usuario que el producto ha procesado la información recibida, tras mostrar esta pantalla durante 2 segundos el producto se reiniciará:



4. Mantenimiento y limpieza

El producto no necesita ningún tipo de mantenimiento. Recomendamos la limpieza de todo el producto (parte trasera, inferior del radiador, aletas superiores, etc.) No utilice ningún producto abrasivo en el aluminio, límpielo con un paño húmedo y jabón pH neutro y la pantalla con un paño seco.

Normativa Europea 2012/19/UE

En base a la normativa europea 2012/19/UE de Residuos de Aparatos Eléctricos y Electrónicos (RAEE), dichos aparatos no pueden ser arrojados en los contenedores municipales habituales; tienen que ser recogidos selectivamente para optimizar la recuperación y reciclado de los componentes y materiales que los constituyen, y reducir el impacto en la salud humana y el medio ambiente. El símbolo del cubo de basura tachado sobre barra horizontal se marca sobre todos los productos Voltomat para recordar al consumidor la obligación de separarlos para la recogida selectiva. El consumidor debe contactar con la autoridad local o con el vendedor para informarse en relación a la correcta eliminación de su aparato.

5. Garantía

En este apartado, se describen las condiciones de garantía que dispone el comprador al haber adquirido un nuevo radiador de la marca Voltomat. Estas condiciones reúnen todos los derechos que tiene el comprador de acuerdo con la legislación nacional vigente, así como la garantía y los derechos adicionales que ofrece la marca Voltomat.

5.1. Cualquier incidencia que detecte en su producto Voltomat, puede ser atendida por el vendedor del producto o de una forma más ágil a través del propio fabricante. Voltomat, pone a su disposición un **TELÉFONO DE ASISTENCIA TÉCNICA 868 990 002** donde le indicaremos los pasos a seguir para solucionar dicha incidencia.



Necesitará la referencia de producto (ubicada en la etiqueta de características del producto), número de serie, fecha de compra y la naturaleza del fallo al contactar con nosotros para mejorar la garantía. Además, adjuntar una copia de la factura de compra del producto.

5.2. Voltomat garantiza que este producto no presenta ningún defecto material, de diseño o de fabricación en el momento de su adquisición original y durante un periodo de 36 meses en componentes eléctricos y electrónicos.

5.3. Si durante el periodo de garantía el radiador no funciona correctamente con un uso normal, y sea fallo de diseño, de los materiales o de fabricación, Voltomat, reparará o sustituirá el radiador, según estime oportuno, según términos y condiciones establecidos a continuación:

5.3.1. La garantía sólo se facilita si presenta el certificado de garantía original emitido por el establecimiento vendedor y cuando la citada garantía este correctamente rellena incluyendo referencia de producto, número de serie (reflejado en la etiqueta de características técnicas del producto), fecha de compra y sello del vendedor.

Voltomat se reserva el derecho de rechazar el servicio de garantía cuando esta información haya sido retirada o rectificadada tras la compra original del producto.

5.3.2. La garantía tan solo se aplica a los casos relativos a defectos de material, diseño o defecto de fabricación, en ningún caso cubre daños del radiador por los siguientes motivos:

5.3.2.1 Uso incorrecto del producto, para otros fines que los normales o por no respetar las instrucciones de uso y mantenimiento dadas por Voltomat, así como la instalación o el uso del producto de alguna forma que incumpla los estándares técnicos de seguridad vigentes. Reparaciones no autorizadas realizadas por personal no autorizado o la apertura del radiador por personas no autorizadas. Accidentes imprevistos fuera del control de Voltomat, como rayos, incendios, inundaciones, desordenes públicos, etc.

5.3.2.2 Las reparaciones o sustituciones que contemplan esta garantía no permiten la extensión ni

nuevo comienzo del período de garantía.

5.3.2.3 Las reparaciones o reemplazos cubiertos en esta garantía se deben hacer con unidades funcionalmente equivalentes. Las piezas defectuosas o piezas retiradas o reemplazadas pasarán a ser propiedad de Voltomat.

5.4. El servicio técnico de Voltomat le podrá asesorar si necesita comprar algún repuesto fuera del periodo de garantía.

5.5. Esta garantía no afecta a los derechos legales del comprador previstos por la legislación nacional vigente, ni los derechos del comprador contra los del distribuidor o instalador que surjan a partir del contrato de compraventa.

5.6. En ausencia de una legislación nacional vigente aplicable, esta garantía será la única protección del comprador. Voltomat, sus oficinas y distribuidores e instaladores no se responsabilizarán de ningún tipo de daños, tanto fortuitos como accidentales, derivados de infringir cualquier norma implícita relacionada con este producto.

6. Requisitos de información de normativa ErP. Reglamento de la Comisión (EU) 2015/1188

| Partida | Símbolo | Unidad | VOLTIW6500 | VOLTIW7500 | VOLTIW10000 | VOLTIW12500 | VOLTIW15000 | VOLTIW17500 |
|--|-------------|--------|------------|------------|-------------|-------------|-------------|-------------|
| POTENCIA CALORÍFICA | | | | | | | | |
| Potencia calorífica nominal | P_{nom} | kW | 0,5 | 0,8 | 1,0 | 1,3 | 1,5 | 1,8 |
| Potencia calorífica mínima (indicativa) | P_{min} | kW | N.A.* | N.A.* | N.A.* | N.A.* | N.A.* | N.A.* |
| Potencia calorífica máxima continuada | $P_{max,c}$ | kW | 0,5 | 0,8 | 1,0 | 1,3 | 1,5 | 1,8 |
| CONSUMO AUXILIAR DE ELECTRICIDAD | | | | | | | | |
| A potencia calorífica nominal | e'_{MAX} | kW | 0,500 | 0,750 | 1,000 | 1,250 | 1,500 | 1,750 |
| A potencia calorífica mínima | e'_{MIN} | kW | 0,500 | 0,750 | 1,000 | 1,250 | 1,500 | 1,750 |
| En modo de espera | e'_{SB} | kW | 0,0008 | 0,0008 | 0,0008 | 0,0008 | 0,0008 | 0,0008 |
| TIPO DE CONTROL DE POTENCIA CALORÍFICA / DE TEMPERATURA INTERIOR (SELECCIONE UNO) | | | | | | | | |
| Potencia calorífica de un solo nivel, sin control de temperatura interior | | | - | - | - | - | - | - |
| Dos o más niveles manuales, sin control de temperatura interior | | | - | - | - | - | - | - |
| Con control de temperatura interior mediante termostato mecánico | | | - | - | - | - | - | - |
| Con control electrónico de temperatura interior | | | - | - | - | - | - | - |
| Control electrónico de temperatura interior y temporizador diario | | | - | - | - | - | - | - |
| Control electrónico de temperatura interior y temporizador semanal | | | ● | ● | ● | ● | ● | ● |
| OTRAS OPCIONES DE CONTROL (PUEDEN SELECCIONARSE VARIAS) | | | | | | | | |
| Control de temperatura interior con detección de presencia | | | - | - | - | - | - | - |
| Control de temperatura interior con detección de ventanas abiertas | | | ● | ● | ● | ● | ● | ● |
| Con opción de control a distancia | | | - | - | - | - | - | - |
| Con control de puesta en marcha adaptable | | | ● | ● | ● | ● | ● | ● |
| Con limitación de tiempo de funcionamiento | | | ● | ● | ● | ● | ● | ● |
| Con sensor de lámpara negra | | | - | - | - | - | - | - |
| RENDIMIENTO DE EFICIENCIA ENERGÉTICA ESTACIONAL | η_s | | 39,0% | 39,0% | 39,0% | 39,0% | 39,0% | 39,0% |
| INFORMACIÓN DE CONTACTO | | | | | | | | |
| Vollmat® Heating BAHAG AG Gutenbergstrasse 21 68167 Mannheim Germany | | | | | | | | |

Safety precautions

Children under 3 years of age should be kept out of reach of the appliance unless continuously supervised. Children from the age of 3 years to 8 years should only switch the appliance on/off when it has been placed or installed in its normal intended use position and when they have been given supervision or instruction concerning use of the appliance in a safe way and understand the hazards involved. Children from 3 years of age to 8 years of age should not plug in, adjust or clean the appliance or carry out maintenance operations.

This appliance can be used by children aged from 8 years and above and persons with reduced physical sensory or mental capabilities or lack of experience and knowledge if they are supervised or have been given instruction concerning use of the appliance in a safe way and understand the hazards involved. Children should not play with the appliance. Cleaning and user maintenance should not be carried out by children without supervision. Children must be supervised at all times to ensure that they do not interfere with the product.

This product is filled with a precise amount of special oil that does not need any maintenance. Any repairs requiring the opening of the oil tank must only be done by an competent professional or Harmoni after-sales service personnel, who should also be notified if an oil leak is noticed.

The regulations on discarding oil when the heater is disposed of must be observed. If the power cable is damaged, it must be replaced by the manufacturer, its after-sales service or authorized personnel in order to avoid any damage. The heating appliance must not be placed immediately below a socket outlet.



CAUTION - Some parts of this product may become very hot and cause burns. Particular care should be taken when children and vulnerable persons are present.



DO NOT COVER - To avoid overheating, do not cover the heating appliance. Do not dry clothes or towels on the heater nor leave fabrics, magazines, spray cans, volatile substances or similar objects within 250mm of the heater.

Introduction

Voltomat digital radiators are manufactured with high quality components and include an exclusive electronic temperature programmer. Voltomat digital radiators meet all safety and efficiency requirements and are for fixed installations only. Voltomat digital radiators include:

- TFT Screen
- Easy settings and programming
- Precise electronic thermostat
- Wi-Fi Control

Read the instruction manual carefully to ensure correct operation of the product. It is very important to keep the manual with the product after its installation.

Contents

| | |
|--|----|
| 1. Voltomat Technical Specifications..... | 20 |
| 2. Voltomat system Installation..... | 20 |
| 2.1. Mounting..... | 21 |
| 2.2. Fixing the supports..... | 21 |
| 2.3. Template measurements per model..... | 22 |
| 3. Voltomat system Information & Instructions..... | 23 |
| 3.1. Touchpad..... | 23 |
| 3.2. Screen..... | 23 |
| 3.3. Turn On and Off..... | 24 |
| 3.4. Submenu configuration..... | 24 |
| 3.5. Locking touchpad..... | 25 |
| 3.6. Selecting MANUAL, AUTOMATIC or PILOTE MODE..... | 25 |
| 3.7. Advance features of the Voltomat system..... | 28 |
| 3.8. Wi-Fi pairing..... | 29 |
| 4. Maintenance & Cleaning..... | 30 |
| 5. Guarantee..... | 30 |
| 6. Information requirements for Erp Directive. Commission Regulation (EU) 2015/1188..... | 32 |

1. Voltomat Technical Specifications

| MODEL | VOLTW0500 | VOLTW0750 | VOLTW1000 | VOLTW1250 | VOLTW1500 | VOLTW1750 |
|--|----------------|-----------|-----------|-----------|-----------|-----------|
| No. Elements | 4 | 6 | 8 | 10 | 12 | 14 |
| DIMENSIONS | | | | | | |
| Width (mm) | 425 | 585 | 747 | 907 | 1,069 | 1,230 |
| Height (mm) | 575 | 575 | 575 | 575 | 575 | 575 |
| Depth (mm) | 95 | 95 | 95 | 95 | 95 | 95 |
| Installed Depth (mm) | 120 | 120 | 120 | 120 | 120 | 120 |
| MECHANICAL CHARACTERISTICS | | | | | | |
| Armoured steel heating element | • | • | • | • | • | • |
| High purity aluminium | • | • | • | • | • | • |
| Thermal oil | • | • | • | • | • | • |
| PC/ABS panel with keypad | • | • | • | • | • | • |
| Left side cover PC/ABS | • | • | • | • | • | • |
| Weight (kg) | 8 | 12 | 16 | 20 | 24 | 28 |
| Finish | White RAL 9016 | | | | | |
| ELECTRICAL CHARACTERISTICS | | | | | | |
| Nominal Power (W) | 500 | 750 | 1000 | 1250 | 1500 | 1750 |
| Voltage (V) | 230 V ~ | 230 V ~ | 230 V ~ | 230 V ~ | 230 V ~ | 230 V ~ |
| Current (A) | 2,2 | 3,3 | 4,3 | 5,4 | 6,5 | 7,6 |
| Power per Element (W/Element) | 125 | 125 | 125 | 125 | 125 | 125 |
| INSTALLATION & PROTECTION | | | | | | |
| Template & Installation Kit | • | • | • | • | • | • |
| Safety thermostat | • | • | • | • | • | • |
| Protection Grade | IP 24 | IP 24 | IP 24 | IP 24 | IP 24 | IP 24 |

2. Voltomat system Installation

2.1. Mounting

The product works by means of natural air convection (Figure 1). In order to achieve optimal functioning

and an even distribution of heat, the lower part of the product, once mounted on the wall, must be at least 10-12cm from the floor, and 30cm at the most. As for the sides and above, a minimum distance of between 10-12cm must be left from any wall or brickwork in order for it to function correctly (Figure 2).

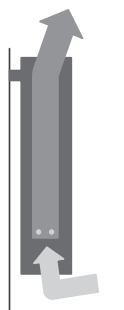

Figure 1

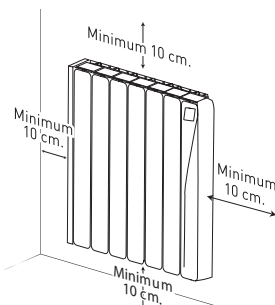

Figure 2

2.2. Fixing the supports

Inside the packaging you will find a fixing kit. Please find the instructions below:



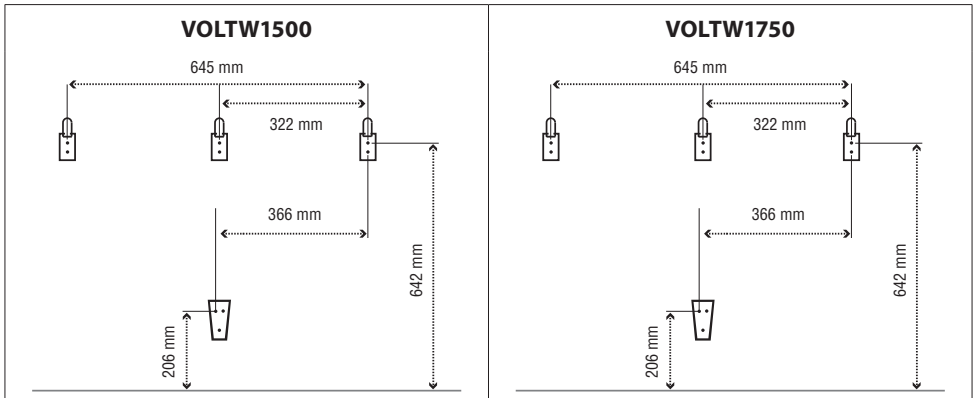
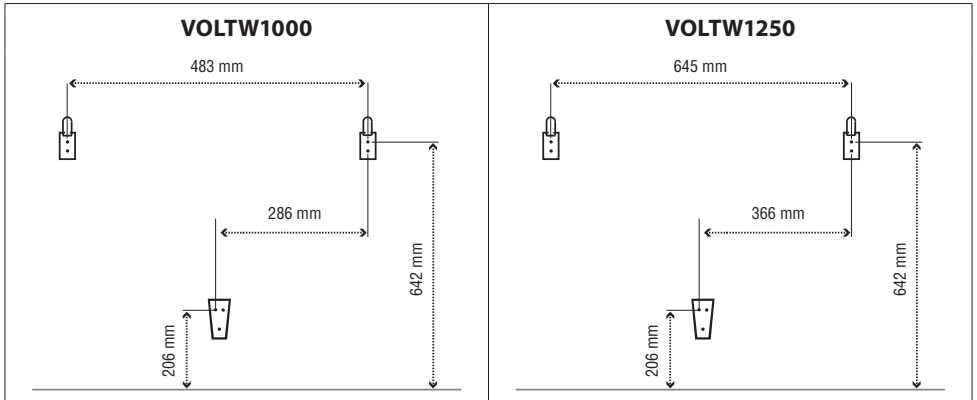
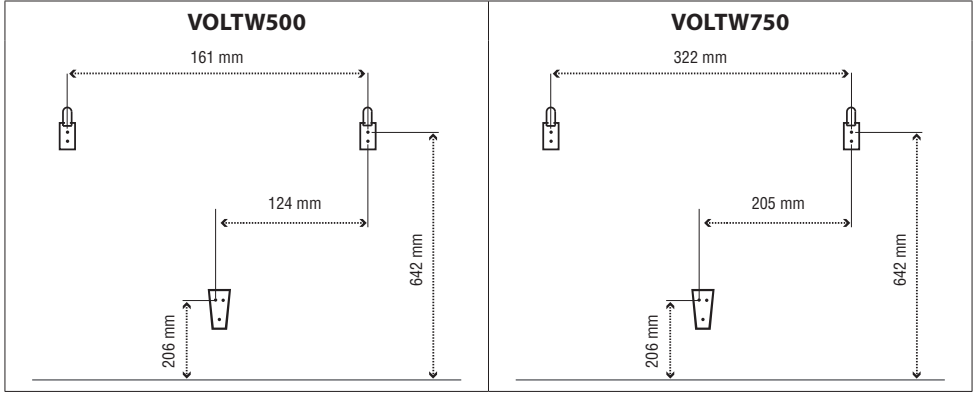

| | | |
|---|---|--|
| | | |
| <ol style="list-style-type: none"> 1. Choose the right part of the wall. 2. Place the mounting stencil on the wall, marking the places for the holes. | <ol style="list-style-type: none"> 3. Remove the stencil and make the holes in the wall. 4. Fix the supports using the plugs and screws provided, or others suitable for the wall type. | <ol style="list-style-type: none"> 5. Check the correct positioning of the lower support. 6. Align the product with the top supports. 7. Place the product in the supports. |

2.3. Template measurements per model



3. Voltomat system Information & Instructions





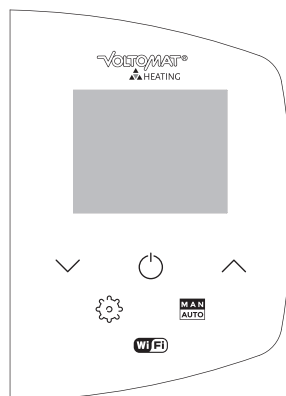



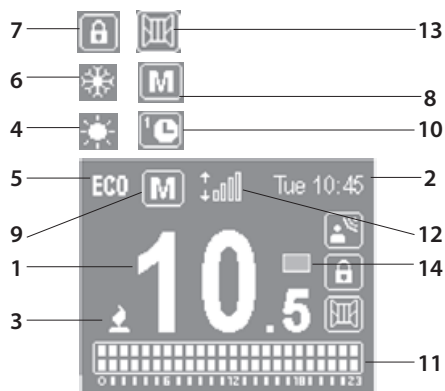





3.1. Touchpad

| | |
|---|----------------------------------|
|  | Settings / Back |
|  | ON/OFF / Confirm |
|  | Decrease temperature / Move down |
|  | Increase temperature / Move up |
|  | Manual mode/ Automatic mode |













3.2. Screen







| | | | | | |
|---|----------------------|---|----|------------------------------|--|
| 1 | Selected temperature |  | 9 | Automatic mode |  |
| 2 | Current time and day |  | 10 | Pre-program mode |  |
| 3 | Heating element on |  | 11 | Hourly programming |  |
| 4 | Comfort mode |  | 12 | Wi-Fi connection indicator |  |
| 5 | Eco mode |  | 13 | Open Windows indicator |  |
| 6 | Anti-Frost mode |  | 14 | Energy consumption indicator |  |
| 7 | Locked keypad |  | | | |
| 8 | Manual mode |  | | | |

3.3. Turn On and Off

To turn the product on press the  button once. To turn off press the  button again. When you turn the product on for the first time, it will ask you to set the date and time. Use the   buttons to select the correct time and press the  button to confirm. Then use the   buttons to select the correct minutes and press . Use the   buttons again to select the correct day and press the  button to confirm.





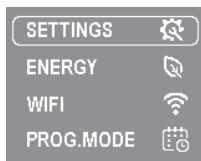



3.4. Submenu configuration

Press the  button to access the configuration menu. Then use the   buttons to navigate to **settings**. Press the  button to access.





3.4.1. Set the day and time

To set the day or time select the **CLOCK** option.

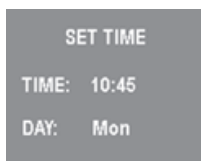
Use the   buttons to select the correct time and press the  button to confirm. Then use the   buttons to select the correct minutes and press the  button to confirm. Then use the   buttons to select the correct day and press the  button to confirm.



3.4.2. Adjust brightness

This function allows you to adjust the brightness when the product is on or in standby. To adjust the brightness, select **BACKLIGHT**. With the   buttons you can turn the brightness up or down. Press the  button to confirm.

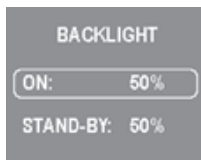

3.4.3. Language

This function allows you to change the language of the product.

To change the language, select **LANGUAGE**. Use the   buttons to select the correct one and press .







3.4.4. Firmware



This option displays the current software version and the release date. To see this press the **FIRMWARE** option.



3.5. Locking touchpad

The buttonpad can be locked using the control panel or the Voltomat App. To lock or unlock the keypad using the product control panel, press and hold the   buttons together for 3 seconds.

The  symbol will appear to the right of the screen. To unlock the keypad, press and hold the   buttons together for 3 seconds.

The  symbol will disappear from the right of the screen. The On/Off burron will still work, even if the control panel is locked. Press the  button for 3 seconds to switch the product on or off.

3.6. Selecting Manual, Automatic or Pilot mode* (*Not available in this product)

To select **MANUAL**, **AUTO**, **PRE-PROGRAMMING** or **PILOT MODE**, access the programming menu by pressing the  button.



MODE – allows you to select between MANUAL or AUTOMATIC mode.

PRE-PROGRAMS – allows you to select one of the 4 default programming schedules.

USER PROGRAM – allows you to edit or create programming.

PILOT WIRE – allows you to activate external control of the product via the pilot wire (not available).

3.6.1. MANUAL mode



When Manual mode is selected, the screen will show: the temperature, the manual icon , the comfort/eco/anti-frost icon, consumption indicator and time and day of the week.



In Manual mode you can choose a temperature and the corresponding icon will be displayed on the screen according to the ranges set in the table below:

| | |
|-------------------|---------------|
| COMFORT | 19 - 30 °C |
| ECO | 7.5 - 18.5 °C |
| ANTI-FROST | 7 °C |

To adjust the temperature:

Use the   buttons to increase or decrease the temperature respectively. When the room temperature is lower than the temperature marked on the radiator, the product will display a  symbol in the upper left of the screen.

3.6.2 AUTOMATIC mode

When automatic mode is selected, the programming already established in the product will be activated. You can choose between the four pre-installed schedules in your Voltomat product:

Pre-programs:

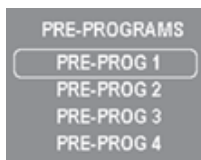









| PRE-PROGRAM 1 | | | | | | | | | | | | | | | | | | | | | | | | |
|---------------|---|---|---|---|---|---|---|---|---|---|----|----|----|----|----|----|----|----|----|----|----|----|----|----|
| | 0 | 1 | 2 | 3 | 4 | 5 | 6 | 7 | 8 | 9 | 10 | 11 | 12 | 13 | 14 | 15 | 16 | 17 | 18 | 19 | 20 | 21 | 22 | 23 |
| Mon-Fri | | | | | | | | | | | | | | | | | | | | | | | | |
| Sat-Sun | | | | | | | | | | | | | | | | | | | | | | | | |





| PRE-PROGRAM 2 | | | | | | | | | | | | | | | | | | | | | | | | |
|---------------|---|---|---|---|---|---|---|---|---|---|----|----|----|----|----|----|----|----|----|----|----|----|----|----|
| | 0 | 1 | 2 | 3 | 4 | 5 | 6 | 7 | 8 | 9 | 10 | 11 | 12 | 13 | 14 | 15 | 16 | 17 | 18 | 19 | 20 | 21 | 22 | 23 |
| Mon-Fri | | | | | | | ■ | ■ | ■ | ■ | ■ | ■ | ■ | ■ | ■ | ■ | ■ | ■ | ■ | ■ | ■ | ■ | ■ | ■ |
| Sat-Sun | | | | | | | ■ | ■ | ■ | ■ | ■ | ■ | ■ | ■ | ■ | ■ | ■ | ■ | ■ | ■ | ■ | ■ | ■ | ■ |



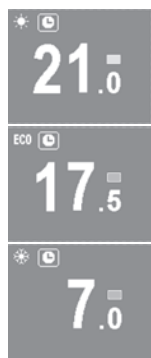

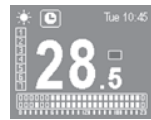

| PRE-PROGRAM 3 | | | | | | | | | | | | | | | | | | | | | | | | |
|---------------|---|---|---|---|---|---|---|---|---|---|----|----|----|----|----|----|----|----|----|----|----|----|----|----|
| | 0 | 1 | 2 | 3 | 4 | 5 | 6 | 7 | 8 | 9 | 10 | 11 | 12 | 13 | 14 | 15 | 16 | 17 | 18 | 19 | 20 | 21 | 22 | 23 |
| Mon-Sun | ■ | ■ | ■ | ■ | ■ | ■ | ■ | ■ | ■ | ■ | ■ | ■ | ■ | ■ | ■ | ■ | ■ | ■ | ■ | ■ | ■ | ■ | ■ | ■ |

| PRE-PROGRAM 4 | | | | | | | | | | | | | | | | | | | | | | | | |
|---------------|---|---|---|---|---|---|---|---|---|---|----|----|----|----|----|----|----|----|----|----|----|----|----|----|
| | 0 | 1 | 2 | 3 | 4 | 5 | 6 | 7 | 8 | 9 | 10 | 11 | 12 | 13 | 14 | 15 | 16 | 17 | 18 | 19 | 20 | 21 | 22 | 23 |
| Mon-Fri | | | | | | | ■ | ■ | ■ | ■ | ■ | ■ | ■ | ■ | ■ | ■ | ■ | ■ | ■ | ■ | ■ | ■ | ■ | ■ |
| Sat-Sun | | | | | | | ■ | ■ | ■ | ■ | ■ | ■ | ■ | ■ | ■ | ■ | ■ | ■ | ■ | ■ | ■ | ■ | ■ | ■ |



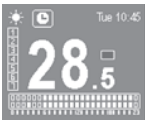

If you want to create your own programming:

| STEP 1 | |
|--|--|
| <p>1. Select COMFORT:</p> <p>Temperature between: 19 – 30°C. Use the   buttons to adjust the temperature. Press  to confirm.</p> <p>2. Select ECO:</p> <p>Temperature between: 7.5 – 18.5°C. Use the   buttons to adjust the temperature. Press  to confirm.</p> <p>3. Select ANTIFROST or OFF:</p> <p>Between: 7°C – OFF. Use the   buttons to adjust the temperature. Press  to confirm.</p> |  |





| STEP 2 | |
|---|---|
| <p>1. Select the days:</p> <p>You can select the days to include in programming by a short press on the  button. The days marked must be highlighted by a box.</p> <p>Use the   buttons to move between the days. Press  after day 7 to go to the next step.</p> |  |

| STEP 3 | |
|---|---|
| <p>1. Select the programming mode for the hours:</p> <p>Use the   buttons to move between the hours. Select a programming mode (COMFORT / ECO / ANTI-FROST) for each hour using the  button. One press will select COMFORT, another press for ECO and a third press selects ANTI-FROST.</p> <p>a. In the top right it will indicate which hour you are programming.</p> <p>b. In the left side it will show you the days selected.</p> <p>c. The programming bar will show.</p> <p>I. COMFORT mode: 2 filled squares </p> <p>II. ECO mode: bottom filled square </p> <p>III. ANTI-FROST/OFF mode: 2 empty squares </p> <p>Once you have programmed a mode for every hour, press  to confirm and save your programming</p> |  |

3.7. Advanced features of the Voltomat system

The Voltomat system includes three advanced functions: Open Windows, Balance and Adaptative Mode. To activate or deactivate one of the functions below, press the  button to access the settings menu. Use the   buttons to scroll through the menu until you find the **POWER** submenu. Press the  button to access the submenu:



By accessing each of them, you can activate or deactivate its operation. Once selected, press the  button and use the   buttons to activate or deactivate the function. Press the  button once more to confirm the option.

3.7.1. OPEN WINDOWS function

The Voltomat system has the OPEN WINDOWS  function activated as a default. This function is activated when the sensor detects that there has been a temperature decrease of 4°C in a period of 30 minutes. The OPEN WINDOWS mode is activated for two hours. When the OPEN WINDOWS mode is active, the radiator will be in ANTI-FROST mode at 7°C.

3.7.2. BALANCE function

The **BALANCE** submenu causes the product to work in Manual mode with a constant temperature of 19°C. Once selected, the product returns to the main screen, with the temperature set at 19°C and the **MANUAL** function icon activated.

3.7.3. ADAPTATIVE mode

Adaptive mode allows the product to learn how long it will take to heat the room to your desired temperature. It predicts the ideal time to activate the heating element to reach the temperature set, at exactly the right time you programmed, saving you time, energy and money.

3.8. Wi-Fi pairing

The Wi-Fi submenu allows you to enable / disable the connection and perform pairing with a device. Selecting the option "pair the product" will create its own network to which you can connect your device.

The following screen will show the data of the created network (NET) and the password (PIN) for the product you want to pair.



When the device is connected to the radiator network, the following display will appear:



When the product has received the configuration from the mobile device, it will start processing and display the following screen:



This screen indicates to the user that the product has processed the information received. After displaying this screen for 2 seconds the product will restart.



4. Maintenance & Cleaning

The product does not require any type of maintenance. We recommend that all parts of the product are kept clean (behind, underneath, upper fins, etc.). Do not use any abrasive product on the aluminium. Clean it with a damp cloth and a pH neutral soap, and the control panel with a dry cloth.

European Directive 2012/19/UE

Under the European Directive 2012/19/UE on waste electrical and electronic equipment (WEEE), the product cannot be disposed in the usual council bins and containers. They must be separated to optimize the recovery and recycling of all of the components and materials and reducing the impact to human health and the environment. The symbol of the container crossed out over a horizontal line is marked on all of Voltomat products to remind the consumer of the obligation to separate them on disposal. The consumer should contact the local authority or original point of sale to learn more about the correct disposal of this product.

5. Guarantee

In this section, we hereby describe the guarantee conditions which the buyer acquires on buying a new Voltomat product. These conditions comply with all the rights construed in the national legislation in force, as well as any additional rights and guarantees which are offered by Voltomat.

5.1. Any incident that you might detect in your Voltomat product can be sorted by the product seller or quickly by the manufacturer. Please **contact Voltomat by telephoning 868 990 002** for technical support.

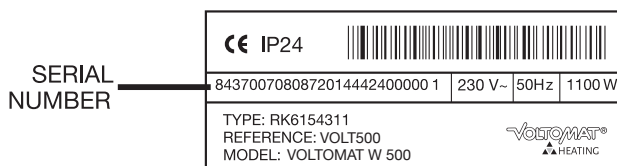

You will need to state the product reference (located on the label indicating product features), serial number, proof of purchase and the type of incident at hand when contacting us so that we can check the guarantee. In addition, please attach a copy of the product invoice.

5.2. Voltomat guarantees that there are no material defects of design or manufacture at the time of original acquisition and guarantees the aluminium for a period of 120 months and 36 months for any electronic and electrical components.

5.3. If during the guarantee period, the product does not work correctly under normal use, and any design, material or manufacturing defect is found, Voltomat will repair or substitute the product as it may see fit, in accordance with the terms and conditions as follows:

5.3.1. The guarantee is only applicable if the original guarantee is issued by the seller and when the said guarantee is filled in correctly including product reference, series number (marked on the product's label indicating technical features), purchase date and the seller's stamp.

Voltomat reserves the right to reject the guarantee service when this information has been removed or modified after the original product purchase.

5.3.2. The guarantee only applies to those cases that concern material, design and manufacturing defects, and under no circumstances covers damage to the product for the following reasons:

5.3.2.1 Incorrect use of the product, i.e. used for other purposes that are not construed as its normal use or for not respecting the instructions of use and maintenance given by Voltomat as well as incorrect installation or use of the product that may not comply with the current technical standards of safety.

Corrosion caused by direct exposure to salt water is excluded from the guarantee. When the product is installed no more than 200m from the coast the guarantee for damages caused by corrosion the period will be reduced by 50%.

5.3.2.2 Any unauthorized repairs carried out by unauthorized technicians or opening of the product by unauthorized people.

5.3.2.3 Any accidents that are deemed outside the control of Voltomat, such as lightning, fires, floods, public disorders, etc.

5.3.3. Any repairs or substitutions that are included in this guarantee do not allow any additions or new periods of guarantee.

5.3.4. Any repairs or substitutions covered under this guarantee must be parts that are functionally equivalent. The defective parts or parts removed or replaced shall become the property of Voltomat.

5.4. The technical service of Voltomat will advise you if you need to buy any parts not covered under the guarantee or out of guarantee.

5.5. This guarantee does not affect the buyer's legal rights stipulated in the current national legislation, nor affects those rights against the distributor or installer that could come forth in compliance with the purchase contract.

5.6. In the absence of a national legal legislation applicable, this guarantee shall prevail and may be construed as the buyer's only protection. Voltomat, its offices, distributors and installers may not be held responsible for any accidental damage that emerges due to infringement of any rules implicitly related to this product.

6. Information requirements for Erp Directive. Commission Regulation (EU) 2015/1188.

| Item | Symbol | Unit | VOLTIW6500 | VOLTIW7500 | VOLTIW10000 | VOLTIW12500 | VOLTIW15000 | VOLTIW17500 |
|--|-------------|------|------------|------------|-------------|-------------|-------------|-------------|
| HEAT OUTPUT | | | | | | | | |
| Nominal heat output | P_{nom} | kW | 0,5 | 0,8 | 1,0 | 1,3 | 1,5 | 1,8 |
| Minimum heat output (indicative) | P_{min} | kW | N.A.* | N.A.* | N.A.* | N.A.* | N.A.* | N.A.* |
| Maximum continuous heat output | $P_{max,c}$ | kW | 0,5 | 0,8 | 1,0 | 1,3 | 1,5 | 1,8 |
| AUXILIARY ELECTRICITY CONSUMPTION | | | | | | | | |
| At nominal heat output | e'_{MAX} | kW | 0,500 | 0,750 | 1,000 | 1,250 | 1,500 | 1,750 |
| At minimum heat output | e'_{MIN} | kW | 0,500 | 0,750 | 1,000 | 1,250 | 1,500 | 1,750 |
| In standby mode | e'_{SB} | kW | 0,0008 | 0,0008 | 0,0008 | 0,0008 | 0,0008 | 0,0008 |
| TYPE OF HEAT OUTPUT/ROOM TEMPERATURE CONTROL (SELECT ONE) | | | | | | | | |
| Single stage heat output and no room temperature control | | | - | - | - | - | - | - |
| Two or more manual stages, no room temperature control | | | - | - | - | - | - | - |
| With mechanic thermostat room temperature control | | | - | - | - | - | - | - |
| With electronic room temperature control | | | - | - | - | - | - | - |
| Electronic room temperature control plus day timer | | | - | - | - | - | - | - |
| Electronic room temperature control plus week timer | | | ● | ● | ● | ● | ● | ● |
| OTHER CONTROL OPTIONS (MULTIPLE SELECTIONS POSSIBLE) | | | | | | | | |
| Room temperature control, with presence detection | | | - | - | - | - | - | - |
| Room temperature control, with open window detection | | | ● | ● | ● | ● | ● | ● |
| With distance control option | | | - | - | - | - | - | - |
| With adaptive start control | | | ● | ● | ● | ● | ● | ● |
| With working time limitation | | | ● | ● | ● | ● | ● | ● |
| With black bulb sensor | | | - | - | - | - | - | - |
| SEASONAL SPACE HEATING ENERGY EFFICIENCY | η_s | | 39,0% | 39,0% | 39,0% | 39,0% | 39,0% | 39,0% |
| CONTACT DETAILS | | | | | | | | |
| Vollmat® Heating BAHAG AG Gutenbergstrasse 21 68167 Mannheim Germany | | | | | | | | |

*Not applicable

Notas / Notes

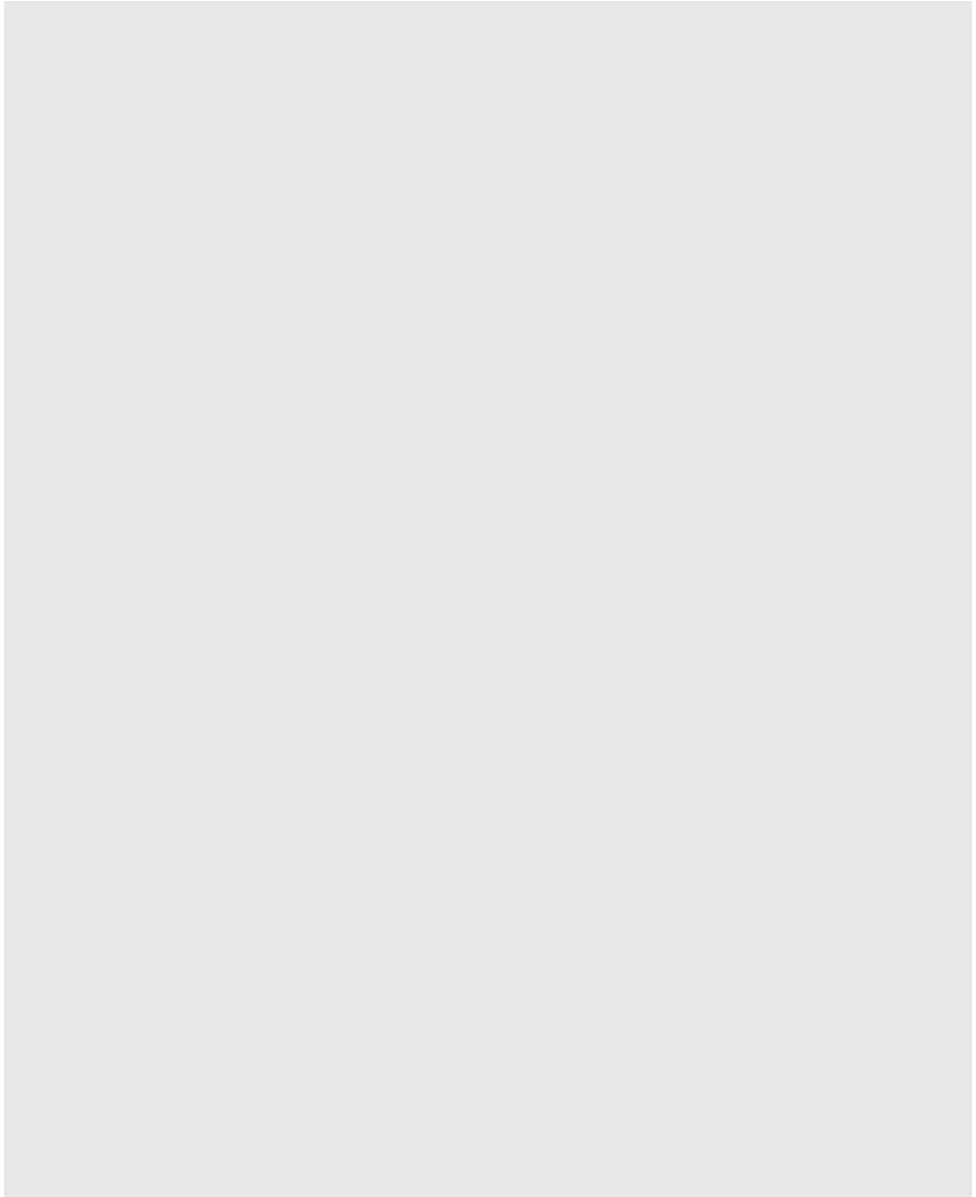

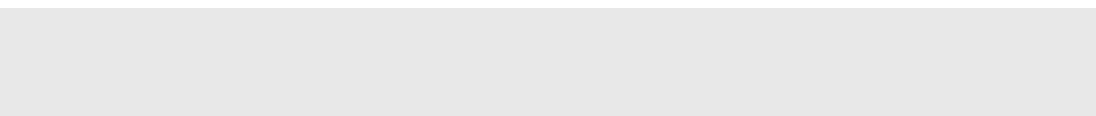
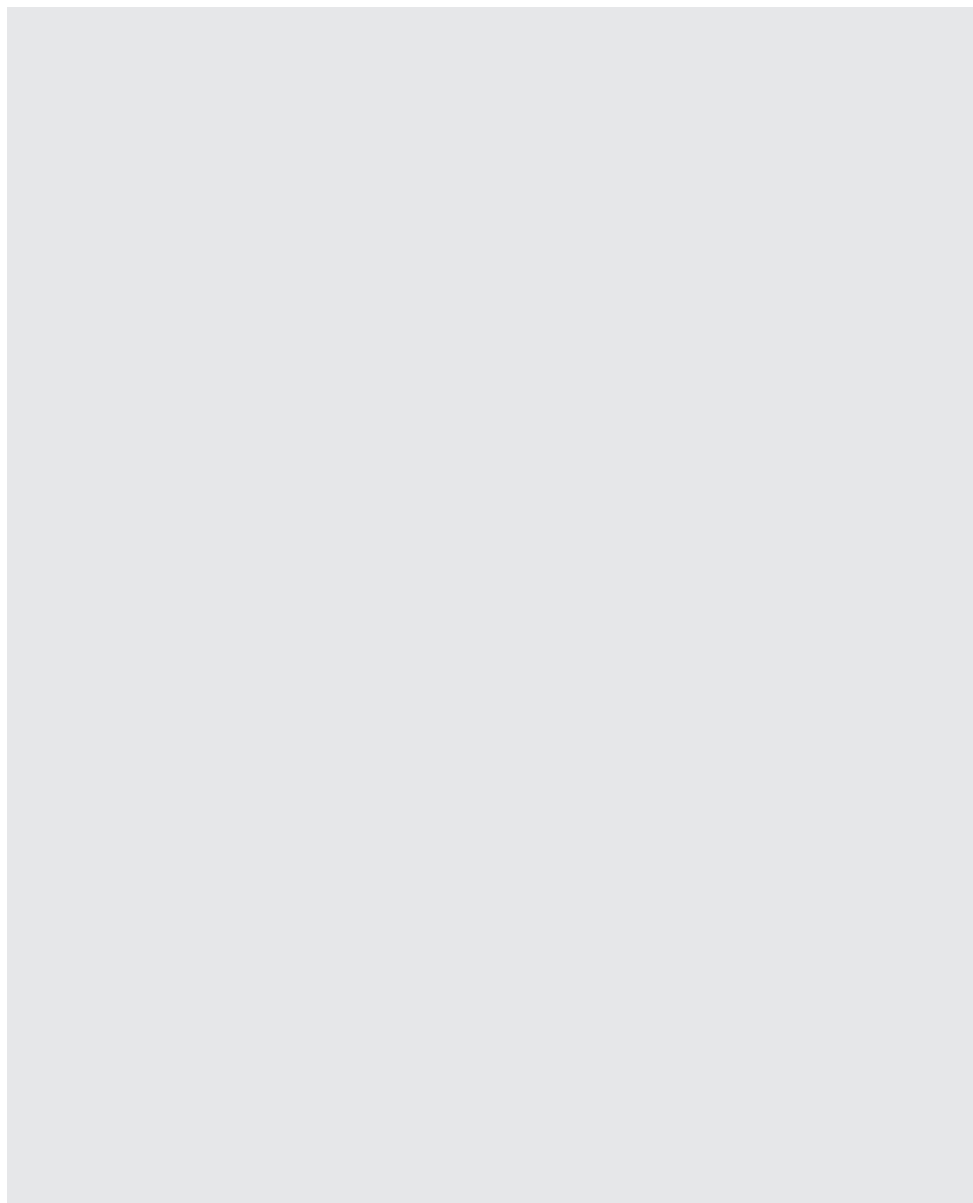



Voltomat® Heating

BAHAG AG

Gutenbergstrasse 21

68167 Mannheim

Germany

Voltomat no puede aceptar ninguna responsabilidad por errores en catálogos, folletos y otros materiales impresos. Voltomat se reserva el derecho de modificar sus productos sin previo aviso. Esto también se aplica a los productos que ya están en orden, siempre que dichas modificaciones se puedan realizar sin modificaciones posteriores a las especificaciones ya acordadas. Todas las marcas comerciales en este material son propiedad de Voltomat. Voltomat y los logotipos de Voltomat son marcas registradas de Voltomat® Heating. Todos los derechos reservados.

Voltomat cannot accept any liability for errors in catalogues, brochures and other printed material. Voltomat reserves the right to modify its products without prior notice. This also applies to products that are already on order, provided that such modifications can be made without further modifications can be made without subsequent changes to the specifications already agreed upon. All trademarks in this material are the property of Voltomat. Voltomat and the Voltomat logos are registered trademarks of Voltomat® Heating. All rights reserved.