

MENABO

PROFESSIONAL

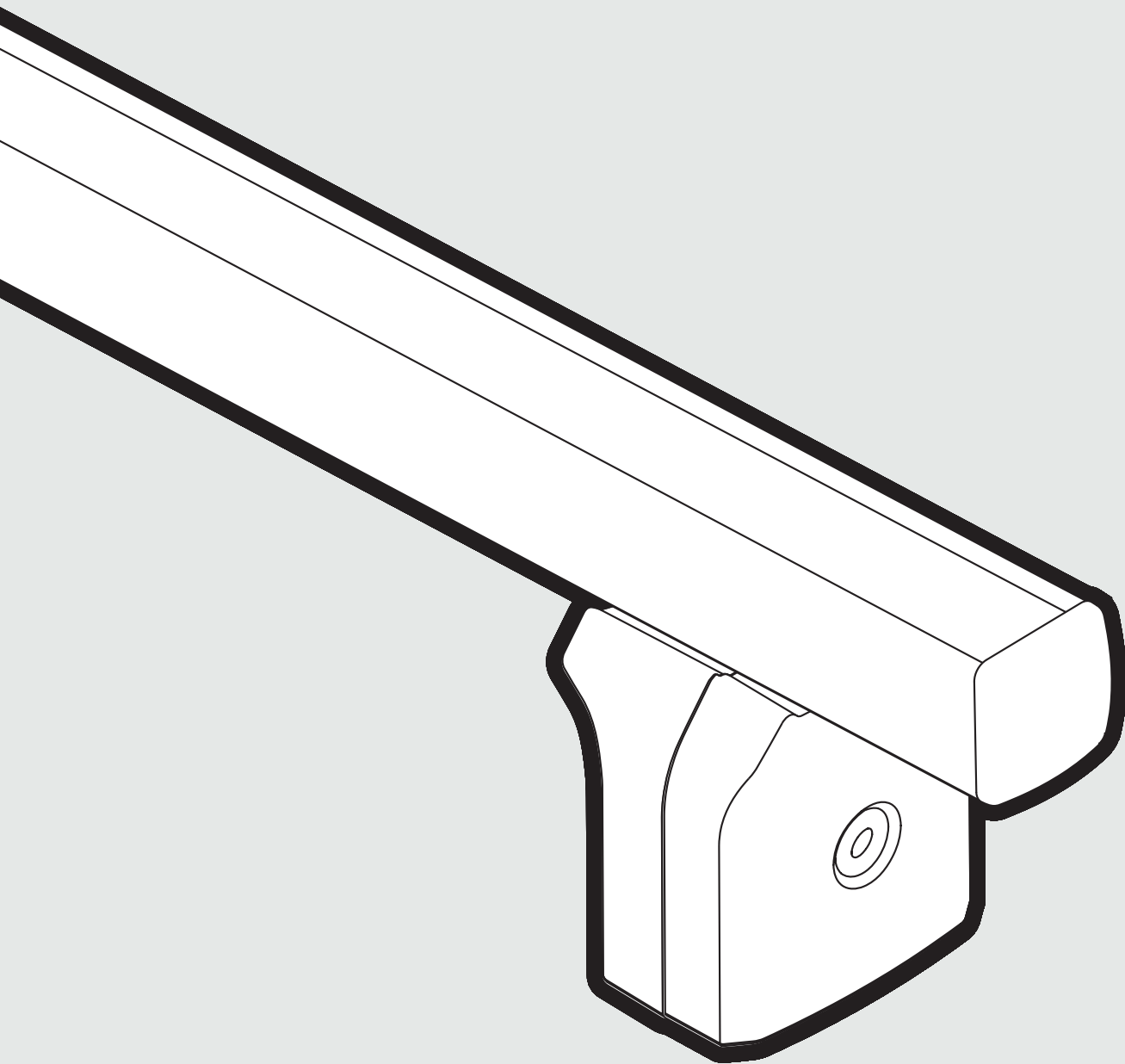

DE ANWENDUNGSLISTE

EN APPLICATION LIST







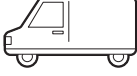

PROFESSIONAL

Professionelle Dachträger, die speziell für Nutzfahrzeuge entwickelt wurden. Das Ergebnis ist ein äußerst vielseitiges System, das Ihre spezifischen Transportanforderungen einfach und sicher erfüllt.

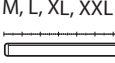
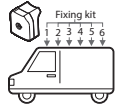
EN) Professional roof racks system designed for commercial vehicles. An extremely versatile system that fits almost all cargo needs simply and safely.



										
					1	2	3	4	5	6
CITROËN	Berlingo II	2	08>18	L	FIX603FP			FIX603FP		
CITROËN	Berlingo II	3	08>18	L	FIX603FP			FIX605FP		FIX603FP
CITROËN	Jumper - L1,L2,L3 - H1,H2,H3	3	94>06	XXL	FIX601FP		FIX601FP			FIX601FP
CITROËN	Jumper II - L1,L2,L3 - H1,H2,H3	3	06>14	XXL	FIX601FP		FIX601FP			FIX601FP
CITROËN	Jumper III - L1,L2,L3,L4 - H1,H2,H3	3	14>	XXL	FIX601FP		FIX601FP			FIX601FP
CITROËN	Jumpy II - L1,L2	4	07>15	L	FIX604FP	FIX604FP		FIX604FP		FIX604FP
CITROËN	Jumpy III - L1,L2	3	16>	L	FIX603FP		FIX603FP		FIX603FP	
CITROËN	Nemo	3	08>	L	FIX603FP		FIX605FP			FIX603FP
CITROËN	Spacetourer	3	16>	L	FIX603FP		FIX603FP		FIX603FP	
DACIA	Dokker Van	3	13>	M	FIX603FP		FIX605FP			FIX603FP
FIAT	Doblò / Doblò Cargo II	3	10>15	L	FIX603FP		FIX605FP			FIX603FP
FIAT	Doblò / Doblò Cargo II	3	15>	L	FIX602FP		FIX605FP			FIX602FP
FIAT	Doblò I	2	01>09	L		FIX603FP				FIX603FP
FIAT	Doblò I	3	01>09	L	FIX603FP		FIX605FP			FIX603FP
FIAT	Doblò II Maxi	3	10>15	L	FIX602FP		FIX605FP			FIX602FP
FIAT	Doblò II Maxi	3	15>	L	FIX602FP		FIX605FP			FIX602FP
FIAT	Ducato II - L1,L2,L3 - H1,H2,H3	3	94>06	XXL	FIX601FP		FIX601FP			FIX601FP
FIAT	Ducato III - L1,L2,L3,L4 - H1,H2,H3	3	06>14	XXL	FIX601FP		FIX601FP			FIX601FP
FIAT	Ducato VI - L1,L2,L3,L4 - H1,H2,H3	3	14>	XXL	FIX601FP		FIX601FP			FIX601FP
FIAT	Fiorino II	3	08>	L	FIX603FP		FIX605FP			FIX603FP
FIAT	Scudo L1 L1	4	07>	L	FIX604FP	FIX604FP	FIX604FP			FIX604FP
FIAT	Scudo II L2	4	07>	L	FIX604FP	FIX604FP		FIX604FP		FIX604FP
FIAT	Talento II - L1,L2	4	14>	XXL	FIX606FP	FIX606FP		FIX606FP		FIX606FP
FORD	Tourneo VII Connect - L1,L2	2	06>14	M	FIX603FP				FIX603FP	
FORD	Tourneo VIII Courier	2	14>	L	FIX603FP					FIX603FP
FORD	Tourneo VIII Coustom - L1,L2	3	14>	XL	FIX606FP		FIX606FP			FIX606FP
FORD	Transit VII Connect - L1,L2	2	06>14	M	FIX603FP				FIX603FP	
FORD	Transit VIII Connect - L1	3	14>	M		FIX603FP		FIX603FP		FIX603FP
FORD	Transit VIII Connect - L1	4	14>	M	FIX603FP		FIX603FP	FIX603FP		FIX603FP
FORD	Transit VIII Connect - L2	5	14>	M	FIX603FP	FIX603FP	FIX603FP		FIX603FP	FIX603FP
FORD	Transit VIII Courier	2	14>	L	FIX603FP					FIX603FP
FORD	Transit VIII Coustom - L1,L2	3	14>	XL	FIX606FP		FIX606FP			FIX606FP
IVECO	Daily 3000/H1 (7,3m3)	3	14>	XXL		FIX601FP		FIX601FP		FIX601FP
IVECO	Daily 3520/H1 (9m3)	3	14>	XXL		FIX601FP		FIX601FP		FIX601FP
IVECO	Daily 3520/H2 (10,8m3)	3	14>	XXL		FIX601FP		FIX601FP		FIX601FP
IVECO	Daily 3520/H2 (10,8m3)	2	14>	XXL		FIX601FP		FIX601FP		FIX601FP
IVECO	Daily 3520/H2 (12m3)	3	14>	XXL		FIX601FP		FIX601FP		FIX601FP
IVECO	Daily 4100 (16m3)	3	14>	XXL		FIX601FP		FIX601FP		FIX601FP
IVECO	Daily 4100 (17,5m3)	3	14>	XXL		FIX601FP		FIX601FP		FIX601FP
IVECO	Daily III - L1,L2,L3 - H1,H2	2	00>06	XXL		FIX601FP				FIX601FP
IVECO	Daily III - L1,L2,L3 - H1,H2	3	00>06	XXL	FIX601FP		FIX601FP			FIX601FP
IVECO	Daily IV - L1,L2,L3 - H1	3	06>14	XXL	FIX601FP		FIX601FP			FIX601FP
IVECO	Daily IV - L1,L2,L3 - H2,H3,H4	3	06>14	XL	FIX601FP		FIX601FP			FIX601FP
MERCEDES	Citan (W415) - L1,L2 - H1,H2	2	12>	M	FIX603FP					FIX603FP
MERCEDES	Citan (W415) - L3	3	12>	M	FIX603FP		FIX605FP			FIX603FP
MERCEDES	Sprinter II (W906) - L1,L2,L3,L4 - H1,H2,H3	6	06>	XXL	FIX606FP	FIX606FP	FIX606FP	FIX606FP	FIX606FP	FIX606FP
MERCEDES	Viano 5P MPV (W447)	4	14>	XL	FIX602FP		FIX602FP	FIX602FP		FIX602FP
MERCEDES	Viano 5P MPV (W639)	4	03>14	XL	FIX602FP		FIX602FP	FIX602FP		FIX602FP
MERCEDES	Vito (W447) - L1,L2,L3 - H1,H2	4	14>	XL	FIX602FP		FIX602FP	FIX602FP		FIX602FP
MERCEDES	Vito (W639) - L1,L2,L3 - H1,H2	4	03>14	XL	FIX602FP		FIX602FP	FIX602FP		FIX602FP
NISSAN	Interstar - H1,H2	3	97>10	XXL		FIX606FP	FIX606FP			FIX606FP
NISSAN	Interstar - L2,L3 - H2,H3	5	97>10	XXL	FIX606FP	FIX606FP	FIX606FP		FIX606FP	FIX606FP
NISSAN	Kubistar - L1,L2	2	97>09	M	FIX603FP					FIX603FP
NISSAN	Nv200	3	09>	L	FIX603FP		FIX603FP			FIX603FP
NISSAN	Nv300 - L1,L2	4	16>	XL	FIX606FP	FIX606FP		FIX606FP		FIX606FP
NISSAN	Nv400 - L1,L2 - H1,H2	3	10>	XXL	FIX606FP			FIX606FP		FIX606FP
NISSAN	Nv400 - L3	5	10>	XXL	FIX606FP		FIX606FP	FIX606FP	FIX606FP	FIX606FP
NISSAN	Primastar - L1,L2 - H1	4	02>14	XXL	FIX603FP	FIX603FP		FIX603FP		FIX603FP
NISSAN	Primastar - L1,L2 - H2	4	02>14	L	FIX603FP	FIX603FP		FIX603FP		FIX603FP
OPEL / VAUXHALL	Combo (C) (2 viti / 2 screws)	2	02>11	M	FIX602FP				FIX602FP	
OPEL / VAUXHALL	Combo (D) Cargo - L1,L2	3	12>	L	FIX602FP		FIX605FP			FIX602FP
OPEL / VAUXHALL	Movano	5	10>	XXL	FIX606FP		FIX606FP	FIX606FP	FIX606FP	FIX606FP
OPEL / VAUXHALL	Movano - L1,L2 - H1,H2	3	10>	XXL	FIX606FP		FIX606FP			FIX606FP
OPEL / VAUXHALL	Movano - L1,L2 - H1,H2	3	97>10	XXL		FIX606FP	FIX606FP			FIX606FP

		MAX 		M, L, XL, XXL 	 Fixing kit					
					1	2	3	4	5	6
OPEL / VAUXHALL	Movano - L2,L3 - H2,H3	5	97>10	XXL	FIX606FP	FIX606FP	FIX606FP		FIX606FP	FIX606FP
OPEL / VAUXHALL	Vivaro (A) - L1,L2 - H1	4	02>14	XXL	FIX603FP	FIX603FP		FIX603FP		FIX603FP
OPEL / VAUXHALL	Vivaro (A) - L1,L2 - H2	4	02>14	L	FIX603FP	FIX603FP		FIX603FP		FIX603FP
OPEL / VAUXHALL	Vivaro (B) - L1,L2	4	14>	XXL	FIX606FP	FIX606FP		FIX606FP		FIX606FP
PEUGEOT	Bipper	3	08>	L	FIX603FP		FIX605FP			FIX603FP
PEUGEOT	Boxer I - L1,L2,L3 - H1,H2,H3	3	94>06	XXL	FIX601FP		FIX601FP			FIX601FP
PEUGEOT	Boxer II	4	06>14	XXL	FIX601FP		FIX601FP	FIX601FP		FIX601FP
PEUGEOT	Boxer II - L1,L2,L3,L4 - H1,H2,H3	3	06>14	XXL	FIX601FP		FIX601FP			FIX601FP
PEUGEOT	Boxer III	4	14>	XXL	FIX601FP		FIX601FP	FIX601FP		FIX601FP
PEUGEOT	Boxer III - L1,L2,L3,L4 - H1,H2,H3	3	14>	XXL	FIX601FP		FIX601FP			FIX601FP
PEUGEOT	Expert II - L1,L2	4	07>15	L	FIX604FP	FIX604FP		FIX604FP		FIX604FP
PEUGEOT	Expert III - L1,L2	3	16>	L	FIX603FP		FIX603FP		FIX603FP	
PEUGEOT	Partner II	2	08>18	L	FIX603FP			FIX603FP		
PEUGEOT	Partner II - L1,L2	3	08>18	L	FIX603FP			FIX605FP		FIX603FP
PEUGEOT	Traveller	3	16>	L	FIX603FP		FIX603FP		FIX603FP	
RENAULT	Kangoo I - L1,L2	2	97>08	M	FIX603FP					FIX603FP
RENAULT	Kangoo II	3	08>	M	FIX603FP		FIX605FP			FIX603FP
RENAULT	Kangoo II - L1,L2	2	08>	M	FIX603FP					FIX603FP
RENAULT	Master I - H1,H2	3	97>10	XXL		FIX606FP	FIX606FP			FIX606FP
RENAULT	Master I - L2,L3 - H2,H3	5	97>10	XXL	FIX606FP	FIX606FP	FIX606FP		FIX606FP	FIX606FP
RENAULT	Master II	5	10>14	XXL	FIX606FP		FIX606FP	FIX606FP	FIX606FP	FIX606FP
RENAULT	Master II - L1,L2 - H1,H2	3	10>14	XXL	FIX606FP		FIX606FP			FIX606FP
RENAULT	Master III	5	10>	XXL	FIX606FP		FIX606FP	FIX606FP	FIX606FP	FIX606FP
RENAULT	Master III - L1,L2 - H1,H2	3	10>	XXL	FIX606FP		FIX606FP			FIX606FP
RENAULT	Trafic II - L1,L2 - H1	4	02>14	XXL	FIX603FP	FIX603FP		FIX603FP		FIX603FP
RENAULT	Trafic II - L1,L2 - H2	4	02>14	L	FIX603FP	FIX603FP		FIX603FP		FIX603FP
RENAULT	Trafic III - L1,L2	4	14>	XXL	FIX606FP	FIX606FP		FIX606FP		FIX606FP
TOYOTA	Proace I - L1,L2	4	13>15	L	FIX604FP	FIX604FP		FIX604FP		FIX604FP
TOYOTA	Proace II	3	16>	L	FIX603FP		FIX603FP		FIX603FP	
TOYOTA	Proace II	4	16>	L	FIX603FP	FIX603FP	FIX603FP	FIX603FP		
TOYOTA	Proace Verso	3	16>	L	FIX603FP		FIX603FP		FIX603FP	
VOLKSWAGEN	Caddy III	2	04>11	M	FIX603FP				FIX603FP	
VOLKSWAGEN	Caddy III	3	11>	M	FIX603FP		FIX605FP			FIX603FP
VOLKSWAGEN	Caddy III Maxi	3	07>11	M	FIX603FP		FIX605FP		FIX603FP	
VOLKSWAGEN	Caddy III Maxi	3	11>	M	FIX603FP		FIX605FP			FIX603FP
VOLKSWAGEN	Caddy IV (2K) - L1,L2	3	15>	M	FIX603FP		FIX605FP			FIX603FP
VOLKSWAGEN	Crafter - L1,L2,L3,L4,L5 - H1,H2,H3	6	06>	XXL	FIX603FP	FIX603FP	FIX603FP	FIX603FP	FIX603FP	FIX603FP
VOLKSWAGEN	T5 Transporter - L1,L2	3	03>14	XL	FIX603FP		FIX603FP			FIX603FP
VOLKSWAGEN	T6 Transporter - L1,L2	3	15>	XL	FIX603FP		FIX603FP			FIX603FP

PROFILSATZ (1 pc)

DE) Aluminiumprofil mit dreifachem Rillendesign für maximale Anpassungsfähigkeit bei der Verwendung. Die verschiedenen Zubehörelemente können kombiniert werden, um sie einzeln oder gemeinsam zu verwenden.

EN) Aluminium profile with three slots to grant the utmost flexibility. It is possible to combine several accessories to be used together or separately.

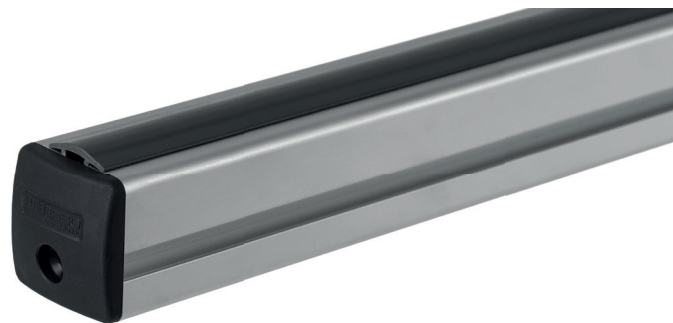

M	Art. 000084200000
L	Art. 000084300000
XL	Art. 000084400000
XXL	Art. 000084500000

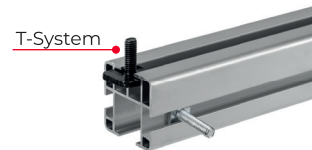
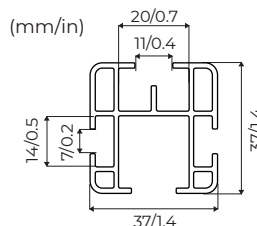

Optional Art.000110100000

BEFESTIGUNGSSATZ (2 pcs)

DE) Einbausatz bestehend aus 4 Elementen: eine universelle Basis, ein Befestigungsbügel, eine Schutzabdeckung und eine Abdeckung.

EN) Fixing kit made of four components: a universal base, a steel bracket, an inner protection cover and an outer cover.

OPTIONAL

Art. 000084800000
DE) Diebstahlsicherungssatz
EN) Antitheft lock

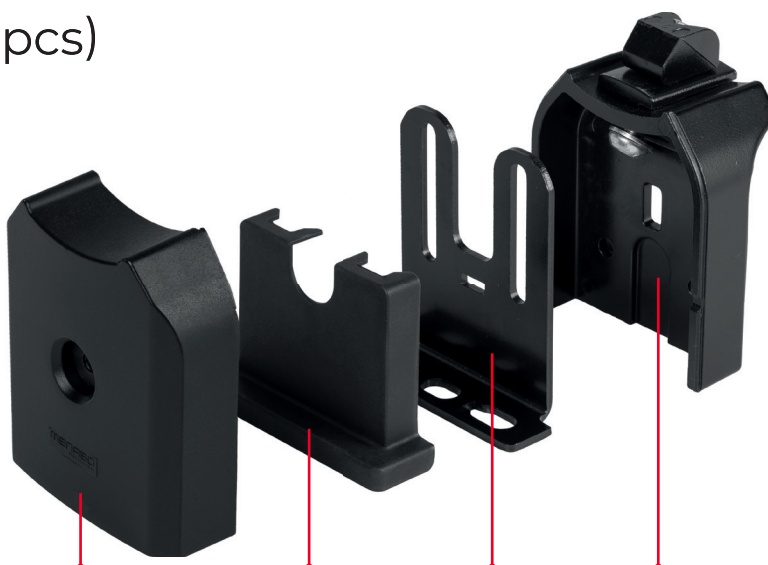

DE) Abdeckung mit Inbusschlüssel.
EN) Cover with outer key fastening.

DE) Schutzabdeckung.
EN) Inner protection cover.

DE) Befestigungsbügel
EN) Steel bracket.

DE) Basisplatte
EN) Universal base.

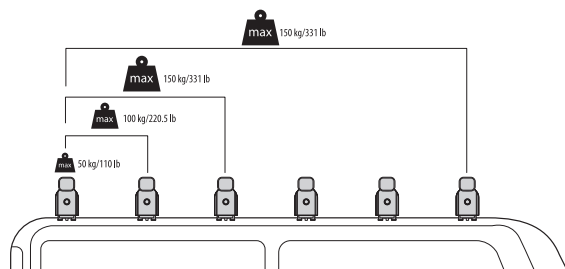

DE) Es werden minimum zwei Profilsätze und Befestigungssätze benötigt. Diese können laut Anwendungsliste je nach benötigter Traglast erweitert werden. Jede Stange hat eine maximale Tragfähigkeit von 50kg/110lb. Je nach Fahrzeug können bis zu 6 Stangen installiert werden, was einer Gesamtkapazität von einer Gesamttragfähigkeit von 150kg/330lb entspricht

EN) A minimum of two profile sets and fixing sets are required. These can be extended according to the application list depending on the required load capacity. Each bar has a maximum load capacity of 50kg/110lb. Depending on the vehicle, up to 6 bars can be installed, which corresponds to a total capacity of 150kg/330lb.

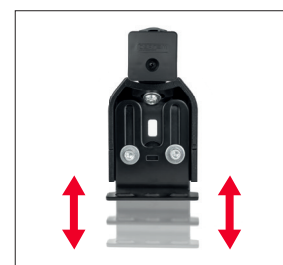

DE) Dank seiner Konstruktion ist es möglich, die Neigung und Höhe der einzelnen Stangen für den sicheren Transport jeder Art von Art der Ladung zu justieren.

EN) Thanks to its design, it is possible to change the angle and the height of each bar, thus allowing a safe cargo of any kind of load.



OPTIONALES ZUBEHÖR FÜR PROFI-TRÄGER PROFESSIONAL ROOF BARS ACCESSORIES

4



LADUNGSSICHERUNG

Art. 000114100000

DE) Stahlrohr zur Sicherung der Ladung auf den Stangen. Set mit 2 Stück.
EN) Steel made foldable cargo holder to secure the load on the bars. 2 pcs set.

1



LADUNGSBEGRENZER SATZ

Art. 000109600000

DE) Unterstützung für die schnelle Befestigung der Ladung auf Stangen.
Set mit 4 Stück.
EN) Cargo holder to secure the load on the bars. 4 pcs set.

2



RINGMUTTER SATZ

Art. 000111700000

DE) Öse für Riemen zum Befestigen.
Set mit 2 Stück.
EN) Cargo ring nuts to secure straps. 2 pcs set.

SPANNGURTE



UNITEC SPANNGURT KLEMMVERSCHLUSS

Art. 75230/75233

DE) 3m 25mm & 5m 25mm
Zurkraft: 400kg
EN) 3m 25mm & 5m 25mm
Lashing force: 400kg



UNITEC SPANNGURT RATSCH

Art.75234

DE) 5m 25mm
Zurkraft: 500kg
EN) 5m 25mm
Lashing force: 500kg



UNITEC SPANNGURT RATSCH-HAKEN

Art.75235

DE) 5m 25mm
Zurkraft: 225kg
EN) 5m 25mm
Lashing force: 225kg



5

ROLLGESTELL

DE) Stütze zur Erleichterung des Aufladens von Gegenständen auf die Stangen durch Verschieben vom Heck des Fahrzeugs aus.
 EN) Roll support to facilitate the loading of objects on the bars by pushing them from the back of the vehicle.

1400mm / 55" Art. 000102500000
 1800mm / 71" Art. 000102600000



6

SEITENSCHIENE

DE) Leichte und stabile Aluminium-Seitenschiene, die die Ladung während der Fahrt stabil halten. 2er Set.
 EN) Lightweight and sturdy aluminium side guards allowing to hold the load in place. 2 pcs set.

1400mm / 55" Art. 000102200000
 1700mm / 67" Art. 000102300000
 1900mm / 75" Art. 000102400000



7

TRANSPORTBOX 3M (BESTELLPRODUKT IM ONLINE-SHOP)
 Art. 000113400000

DE) Rohrträger aus Aluminium für den Transport von Gegenständen bis zu einer maximalen Länge von 3 Metern. Kann sowohl im oberen als auch im seitlichen Kanal platziert werden und ist mit einer Verschlussklappe mit Diebstahlsicherung ausgestattet.
 EN) Aluminium pipes carrier to transport long objects, up to a maximum of 3 meters. It may be positioned in the upper and/or in the side slots and it is equipped with a door with antitheft lock.



