

# **ASSEMBLY** **NOTICE**

Notice de montage  
Montage handleiding  
Montageanleitung  
Manuale d'istruzione  
Instrucciones de montaje  
Instruções de montagem



---

**Plancher pour Décor Home**

---

**4,80x3,48m - DH 15m<sup>2</sup>**

---

**ref 69720-000**

---







Made in Belgium

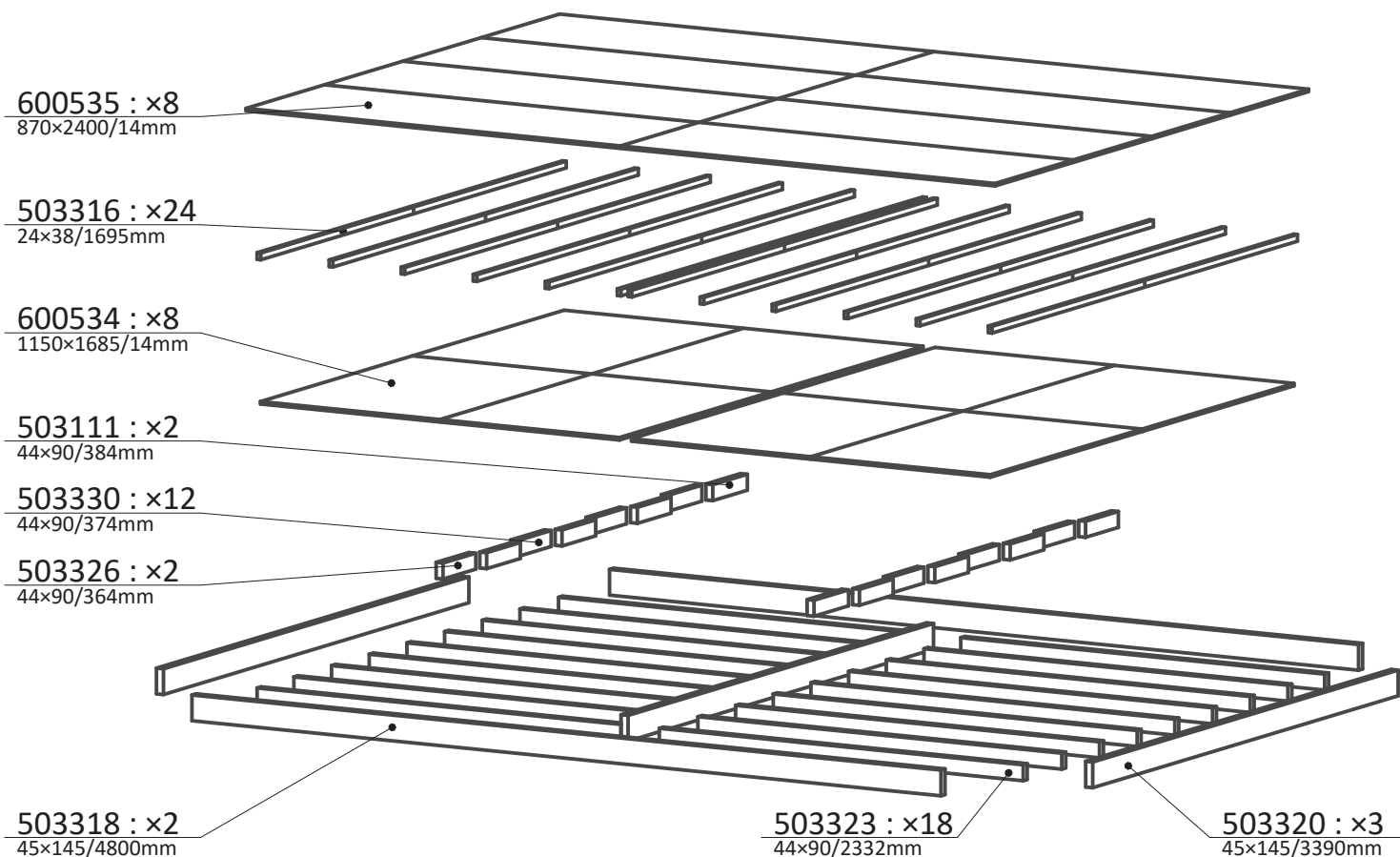

# Plancher pour Décor Home 4,80×3,48m

69720-000

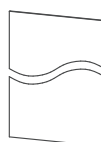
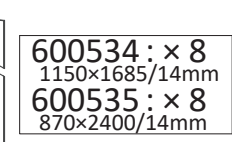

	<b>503316 : × 24</b> 24 × 38 / 1695mm
	<b>503326 : × 2</b> 44 × 90 / 364mm
	<b>503330 : × 12</b> 44 × 90 / 374mm
	<b>503111 : × 2</b> 44 × 90 / 384mm
	<b>503323 : × 18</b> 44 × 90 / 2332mm
	<b>503320 : × 3</b> 45 × 145 / 3390mm
	<b>503318 : × 2</b> 45 × 145 / 4800mm

	<b>600534 : × 8</b> 1150×1685/14mm
	<b>600535 : × 8</b> 870×2400/14mm



Kit 700286			
	3023	ø4×40mm	× 304
	3025	ø4×50mm	× 120
	3045	ø5×80mm	× 16
	3047	ø5×90mm	× 140
	3050	ø6×110mm	× 26

Pare-vapeur (bleu) 		
800072	↓ 2,50m	7,0m

**1**

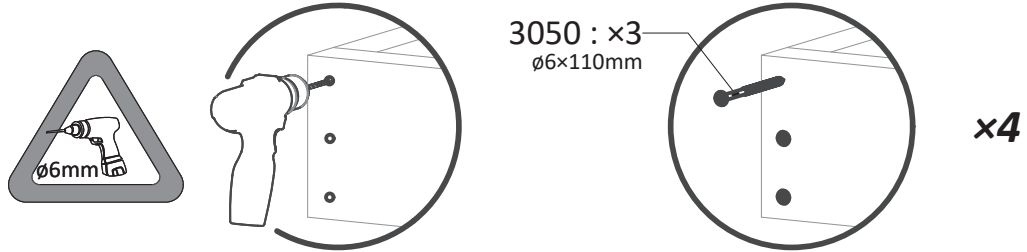
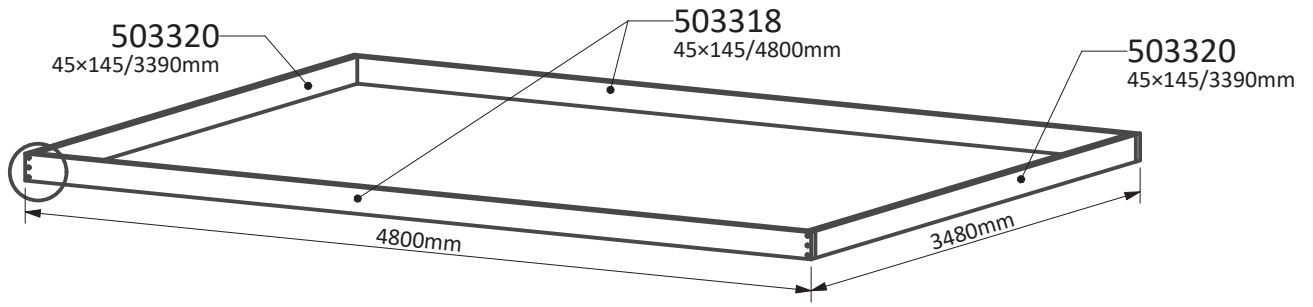

**2**

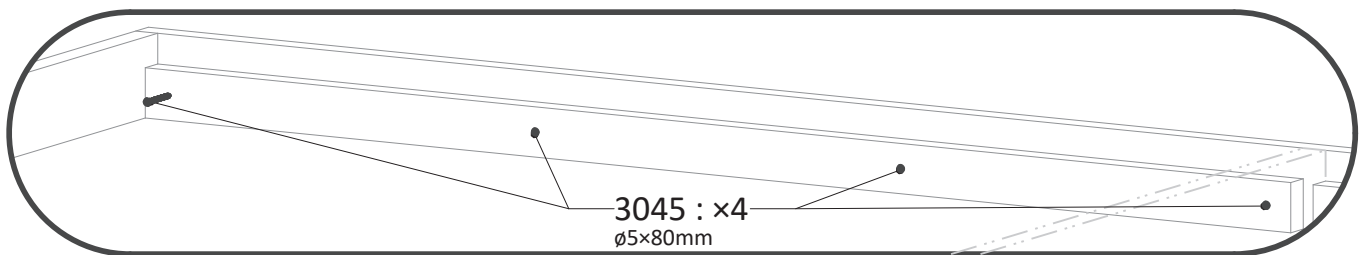
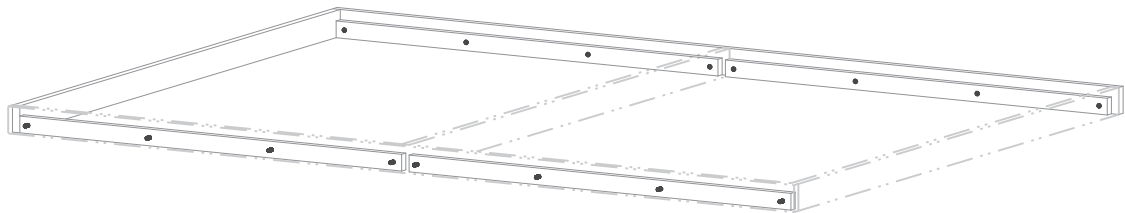
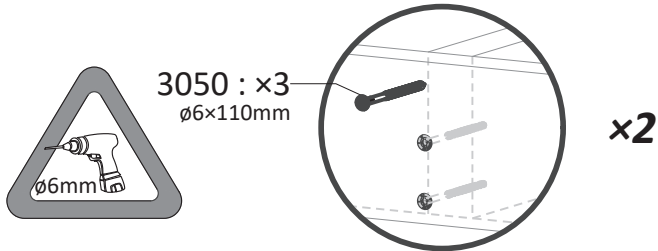
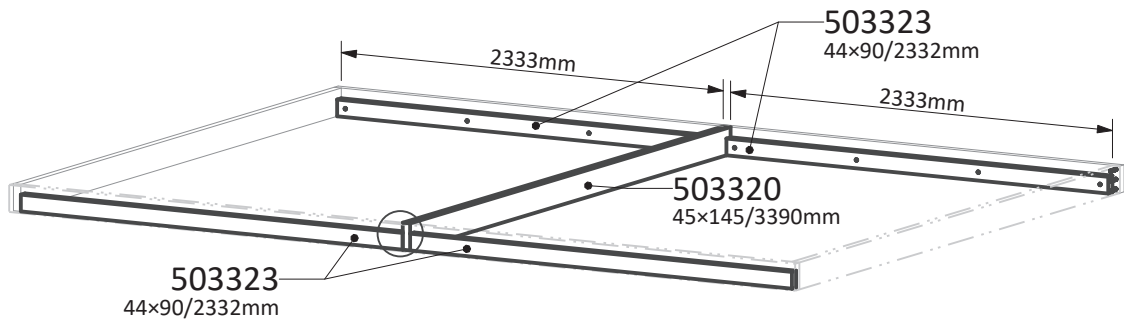

**x4**

# 3

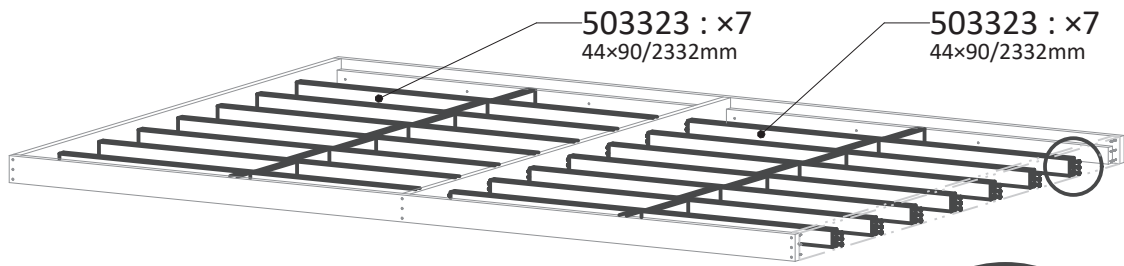

**503111**  
44x90/384mm

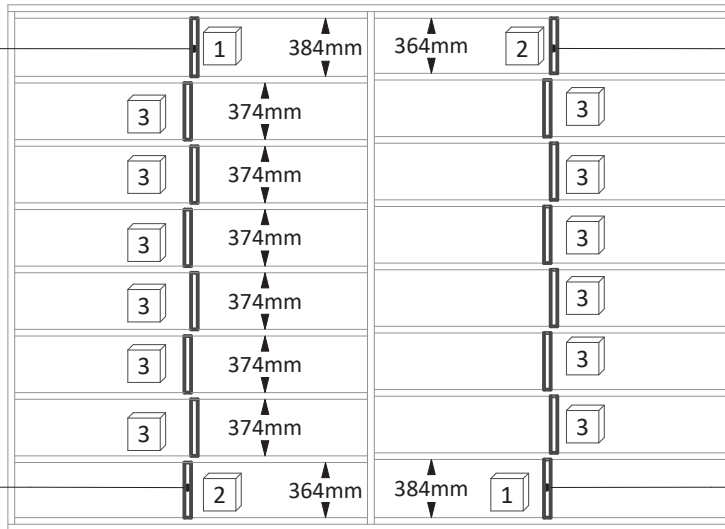

**503326**  
44x90/364mm

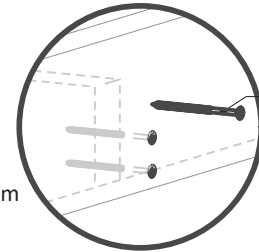

**3047 : x3**  
ø5x90mm



**503330 : x6**  
44x90/374mm  
**x2**

**503326**  
44x90/364mm

**503111**  
44x90/384mm

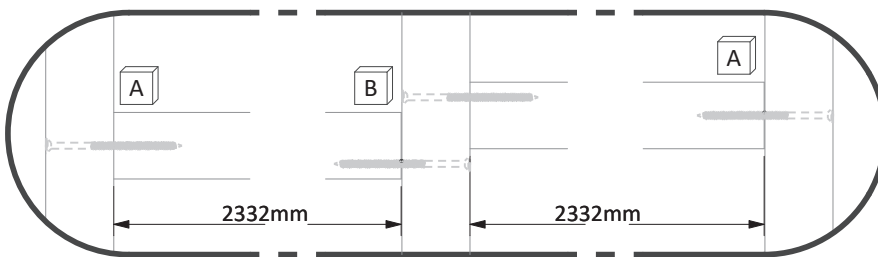

**A** = 14x **3047 : x3**  
ø5x90

**B** = 7x **3047 : x6**  
ø5x90

# 4

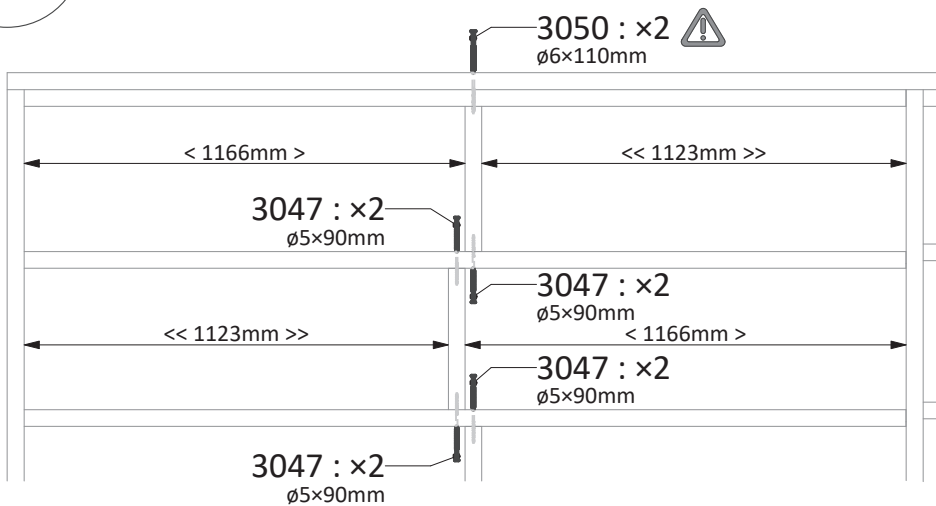

**3050 : x2**  
ø6x110mm

**3047 : x2**  
ø5x90mm

**3047 : x2**  
ø5x90mm

**3047 : x2**  
ø5x90mm

**3047 : x2**  
ø5x90mm

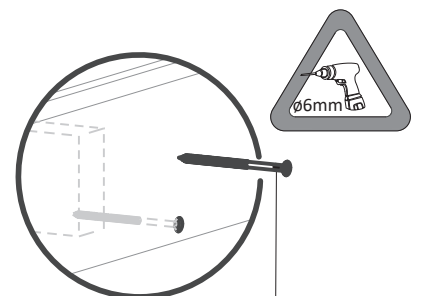

**3050 : x2**  
ø6x110mm  
**x4**

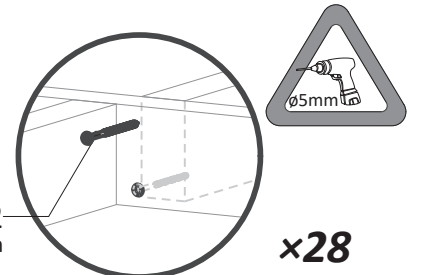

**3047 : x2**  
ø5x90mm  
**x28**

5

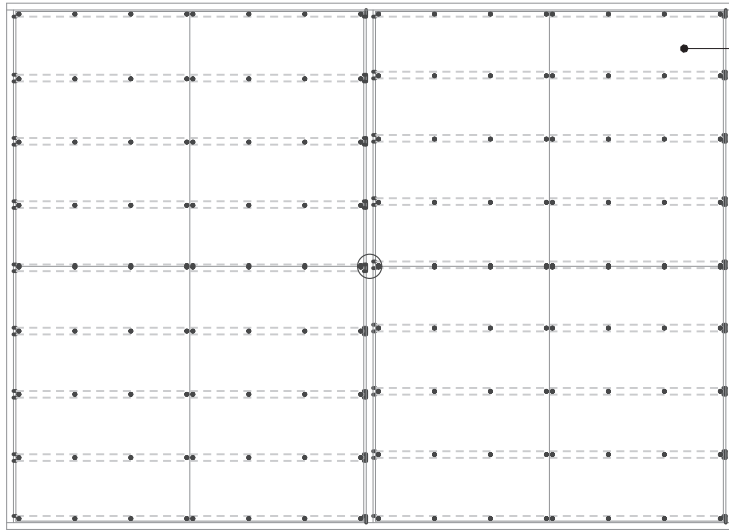
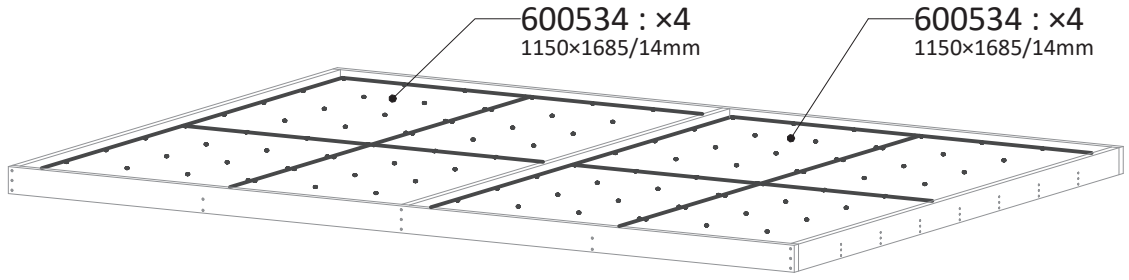

1x 600534  
+  
3023 : x20  
ø4x40 } x8

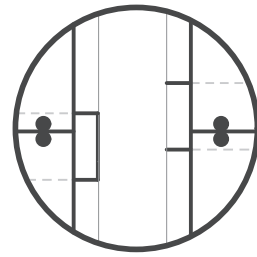

6

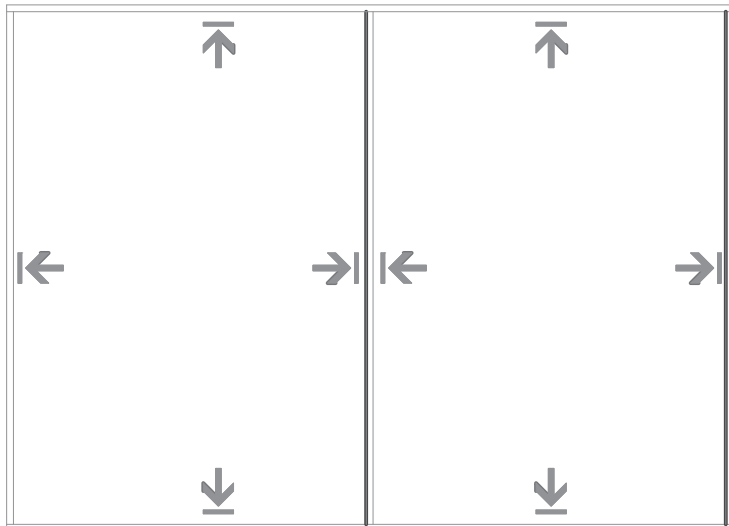
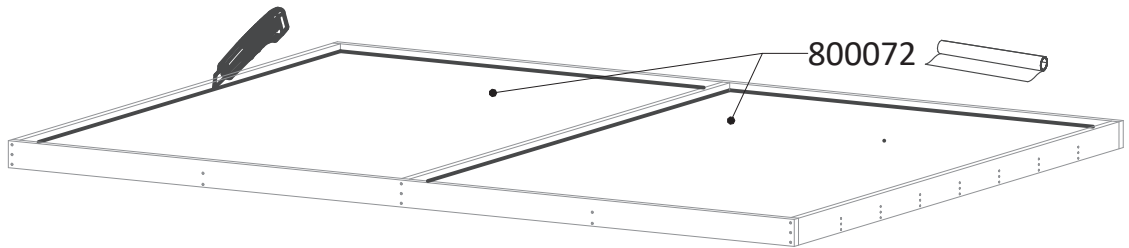

7

503316 : x2  
24x38/1695mm  
x12

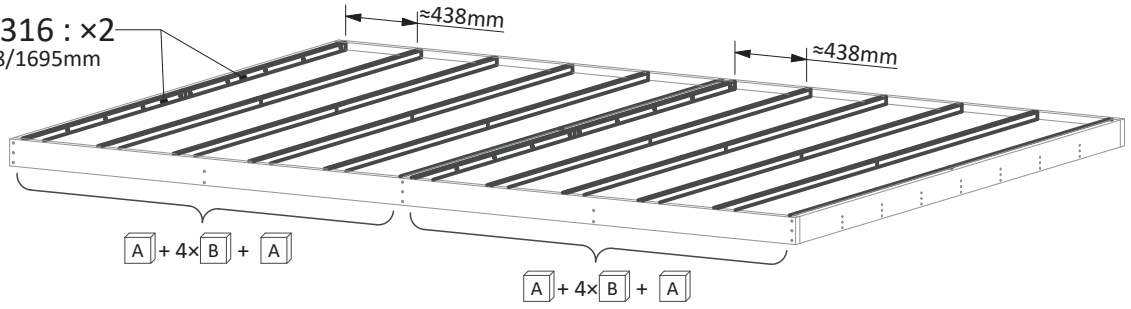

A  
= x4

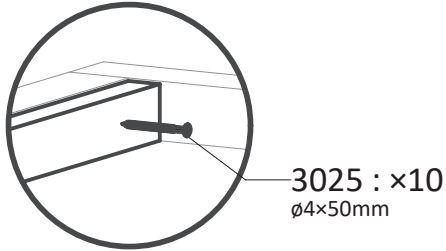

B  
= x8

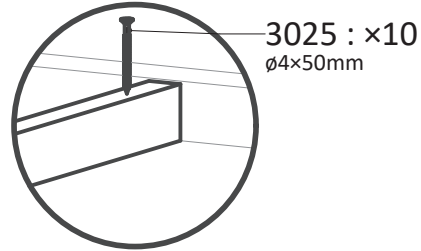

8

600535 : x8  
870x2400/14mm

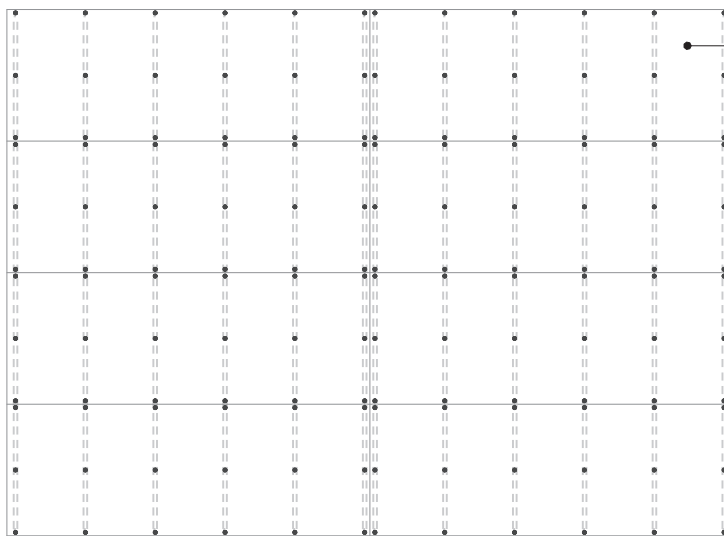
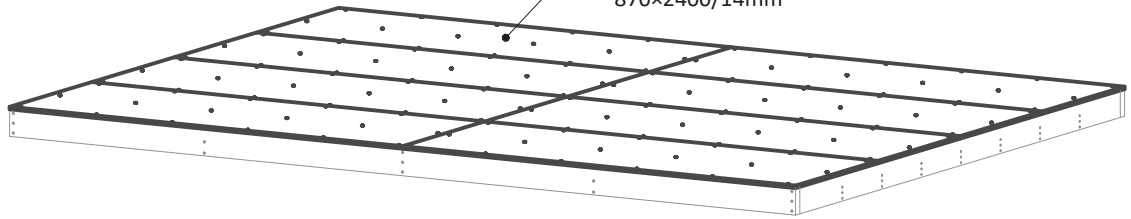

1x 600535  
+ 3023 : x18  
ø4x40 } x8

# Plancher pour Décor Home 4,80×3,48m

69720-000

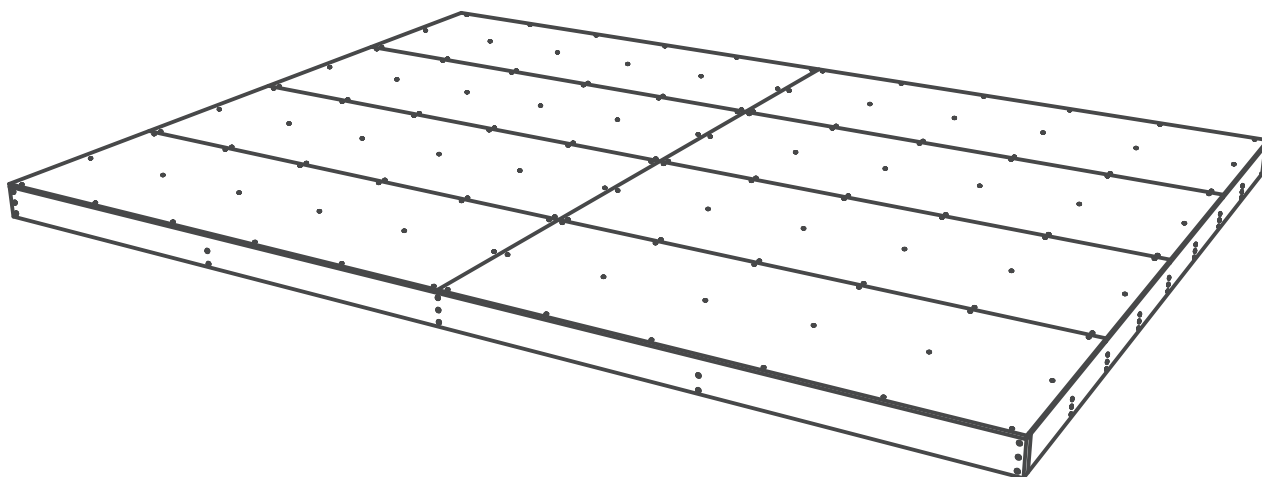

- (EN) **Assembly notice - keep for later reference.**
- (FR) **Notice de montage à conserver pour consultations ultérieures.**
- (NL) **Te bewaren gebruiksaanwijzingen voor latere raadplegingen.**
- (DE) **Montageanleitung nicht wegwerfen, bewahren Sie diese für später.**
- (IT) **Manuale di montaggio da conservare per ulteriori consultazioni.**
- (ES) **Debe conservar las instrucciones de montaje para consultas posteriores.**
- (PT) **Instruções de montagem a guardar para consultas futuras.**

Fabriqué par Décor et Jardin  
Parc Industriel - Rue Nazareth, 13  
4651 Battice - Belgique  
e-mail : [infodecoretjardin.com](mailto:infodecoretjardin.com)  
website : [www.decoretjardin.com](http://www.decoretjardin.com)

