

# LITT

1.32 m<sup>2</sup>

PLUS



MANUAL DE INSTRUCCIONES · USER'S MANUAL · MANUAL DE INSTRUÇÕES  
MANUEL D'INSTRUCTIONS · BENUTZERHANDBUCH · ΕΓΧΕΙΡΙΔΙΟ ΧΡΗΣΗΣ  
PRIROČNIK Z NAVODILI ZA UPORABO · PRIRUČNIK ZA UPORABU



 **Hoggar**<sup>®</sup>

# PRIRUČNIK ZA UPORABU

*Našim cijenjenim klijentima:*

***Hvala što ste odabrali  
jedan od naših proizvoda***

## PRIJE NO ŠTO ZAPOČNETE...

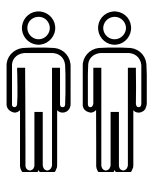

Za montažu  
kućice  
potrebne su  
dvije osobe

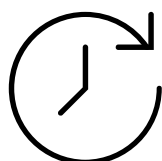

Montaža  
može  
potrajati 2  
do 3 sata



Provjerite kod  
nadležnih tijela  
je li postavljanje  
dopušteno

Savjetujemo vam da pažljivo, korak po korak slijedite ovaj priručnik za uporabu za ispravnu montažu proizvoda.

Provjerite imate li sve dijelove potrebne za montažu i uklonite zaštitnu plastiku prije no što počnete sa sastavljanjem.

Nemojte sastavljati kućicu/ormarić u blizini djece i/ili kućnih ljubimaca.

Planirajte postavljanje proizvoda na suh dan bez vjetera. Izbjegavajte montažu u dane s lošim vremenom kako biste izbjegli oštećenje proizvoda ili osobne ozljede. Kućica nije namijenjena za travnjak kao izravnu podlogu.

Preporučuje se montaža na čvrstoj, ravnoj drvenoj podlozi, ravnoj betonskoj podlozi ili podlozi od cementiranih opeka ili ploča. Vrlo je važno pričvrstiti kućicu za pod. Nisu uključeni vijci ni drugi dijelovi potrebni za pričvršćivanje.

Ako se radi betonska platforma, važno je da ona ima nagib prema rubovima kako bi se izbjegao prodor vode.

Proizvod treba smjestiti na mjestu zaštićenom od vjetera i s dobrom drenažom. Nastojte ga ne postavljati u neposrednoj blizini drveća, jer će biti potrebno redovito čišćenje grana i lišća koji bi mogli padati na njega.

Preporučujemo uklanjati snijeg s metalne kućice nakon svakog sniježenja, inače njegova težina može oštetiti krov kućice.

Nikada nemojte centrirati težinu tijela na krovu.

Za pravilno održavanje preporučuje se kućicu brisati mekom krpom te redovito čistiti vodilicu vrata kako bi pravilno klizila.

Kućice su namijenjene isključivo za čuvanje predmeta, stanovanje i druge namjene su zabranjene.

## ČISTOĆA I ODRŽAVANJE

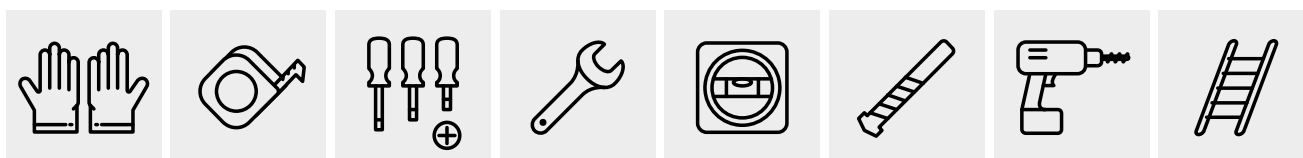

## ČISTOĆA I ODRŽAVANJE

Za pravilno održavanje preporučuje se da proizvod održavate čistim, možete ga čistiti mekom vlažnom krpom.

Na proizvodu nikad nemojte koristiti abrazivne otopine ili deterdžente.

Važno je da krovni odvodni kućice uvijek budu čisti kako se na krovu ne bi skupljala prljavština.

## JAMSTVO

---

Ova kućica izrađena je od materijala vrhunske kvalitete i pod strogim kontrolama i standardima kvalitete. U slučaju bilo kakvih mana na kupljenom proizvodu, obratite se službi za kupce na broj telefona i e-mail koji su navedeni na poledini ovog priručnika za uporabu.

Jamstvo vrijedi od datuma kupnje koji se nalazi na potvrdi ili računu koji je potrebno predložiti za korištenje jamstva.

Jamstveno razdoblje za ovaj proizvod je 10 godina za bilo kakve mane ili kvarove koji su rezultat strukturnog nedostatka ili promjene boje.

### U JAMSTVO NISU UKLJUČENI:







- › Neadekvatan transport. Nakon primitka proizvoda morate obavijestiti agenciju za prijevoz u roku navedenom na dostavnici.
- › Lomovi, štete uzrokovane vremenskim nepogodama kao što su jaki vjetrovi, tuča, poplave itd.
- › Loša montaža, nepravilna uporaba i njihove posljedice.
- › Neodržavanje i dijelovi koji se troše kao što su amortizeri, cilindar, kvaka i šarke.
- › Plastični dijelovi.
- › Čišćenje ili održavanje abrazivnim proizvodima.
- › Mjestimična oštećenja od korozije na dijelovima ili limovima te područja oštećena neizravnim putem poput oštećenja zbog izloženosti morskoj soli koja uzrokuje koroziju. Oštećenja od korozije na rubovima ili kutovima dijelova isključena su iz jamstva.
- › Promjena boje uzrokovana protokom vremena.
- › Ogrebotine na boji.
- › Udarci ili udubljenja u limu.
- › Nepredložene računa ili potvrde o prodaji i neobavještanje na vrijeme i na odgovarajući način.
- › Troškovi nastali rukovanjem neispravnim ili oštećenim dijelovima, kao i odgovornost za neizravne štete koje tako mogu nastati.
- › Uporaba u komercijalne ili druge svrhe osim osobnih ili kućnih.
- › Preinake, bojenje ili montaža koji nisu izvršeni u skladu s odrednicama jamstva i objašnjenjima u priručniku za uporabu, kao i štete uzrokovane prekoračenjem kapaciteta skladištenja proizvoda.

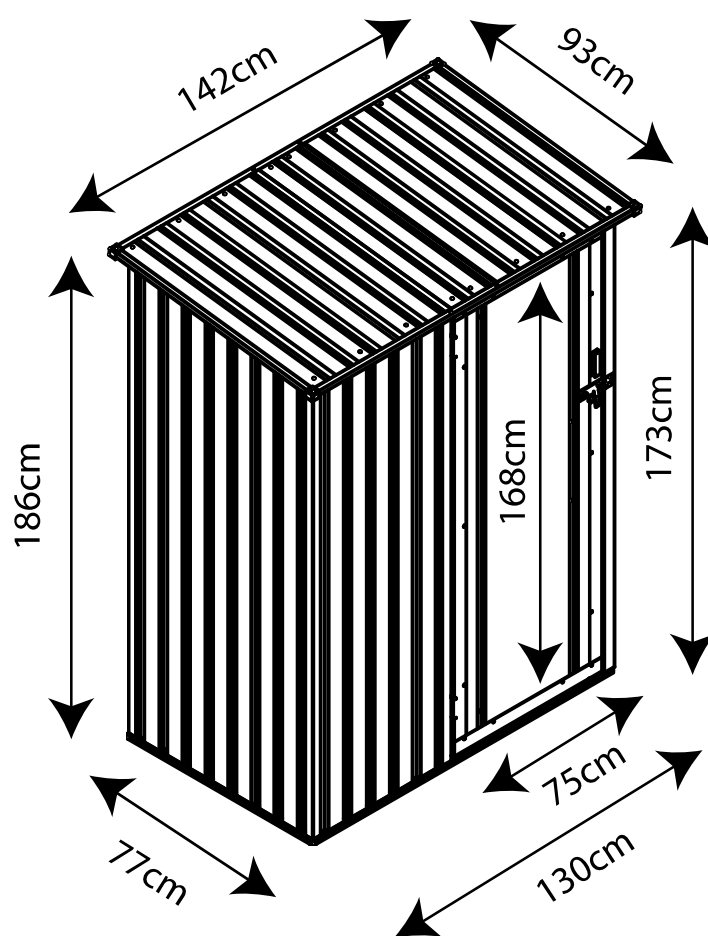

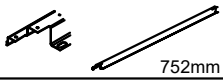
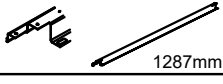
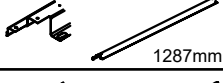
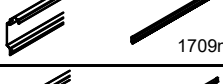
# MONTAJE

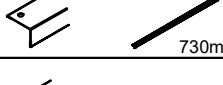
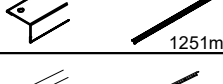
Assembly · Montagem · Montage · Συναρμολόγηση · Montaża

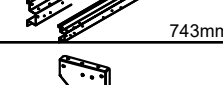
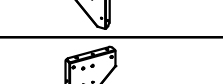
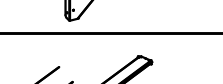
---

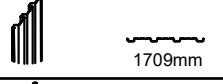
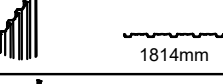
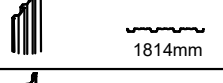
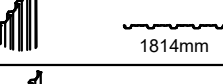
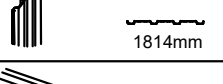
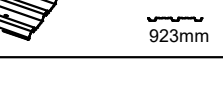
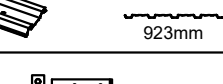
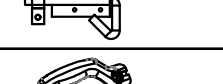
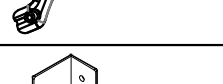

NO.	PART	Qty.
1	 752mm	2
2	 1287mm	1
3	 1287mm	1
4L	 1709mm	1
4R	 1709mm	1
9	 730mm	2
10	 1251mm	1
15	 922mm	2
17	 1411mm	2
18	 743mm	2
25	 2	2
25-1	 2	2
26	 1590mm	1
28	 1251mm	1

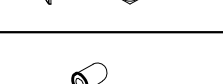
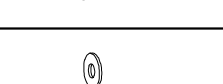
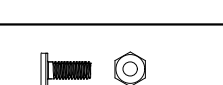
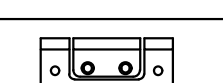
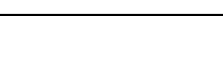
NO.	PART	Qty.
P2	 1709mm	1
P3	 1814mm	2
P4	 1814mm	1
P5	 1814mm	1
P6	 1814mm	1
P7	 923mm	2
P8	 923mm	1
G2	 1	1
GB	 1	1
GC	 4	4
F1	 180	180
F2	 15	15
S2	 180	180
S3	 180	180
F3	 20	20
G3	 3	3

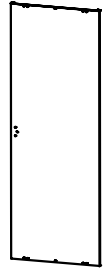
NO.	PART	Qty.
D1	 1678X746mm	1

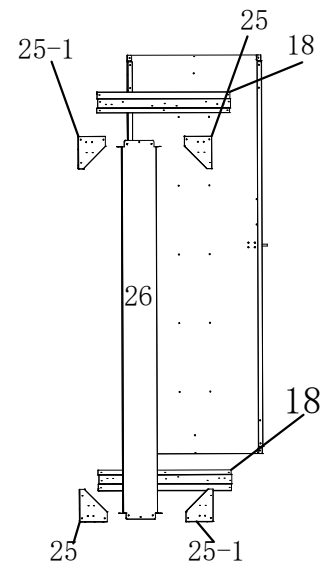
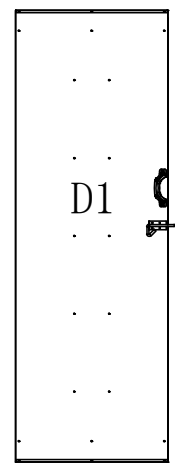
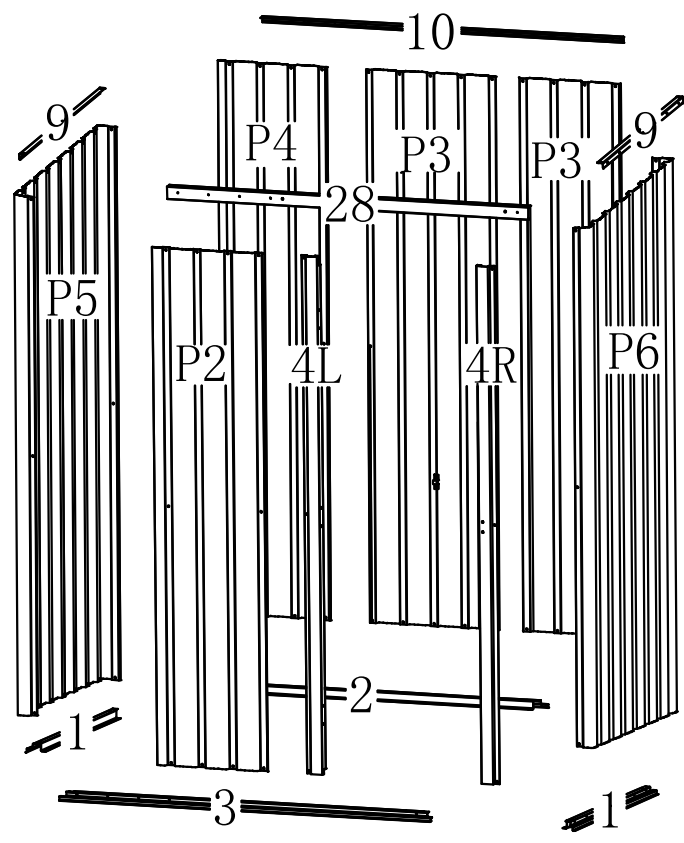
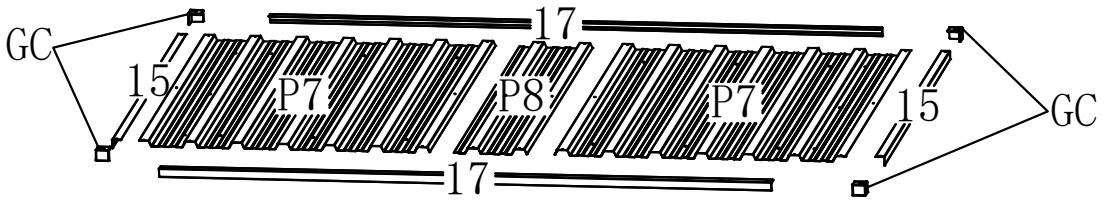

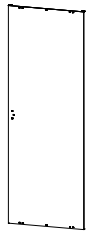

D1x1



18 x 2

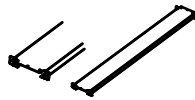

26 x 1

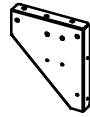

25 x 2

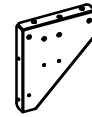

25-1 x 2



GB x 1

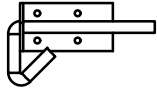

G2 x 1



F1 x 68



F2 x 4



F3 x 6



S3 x 68

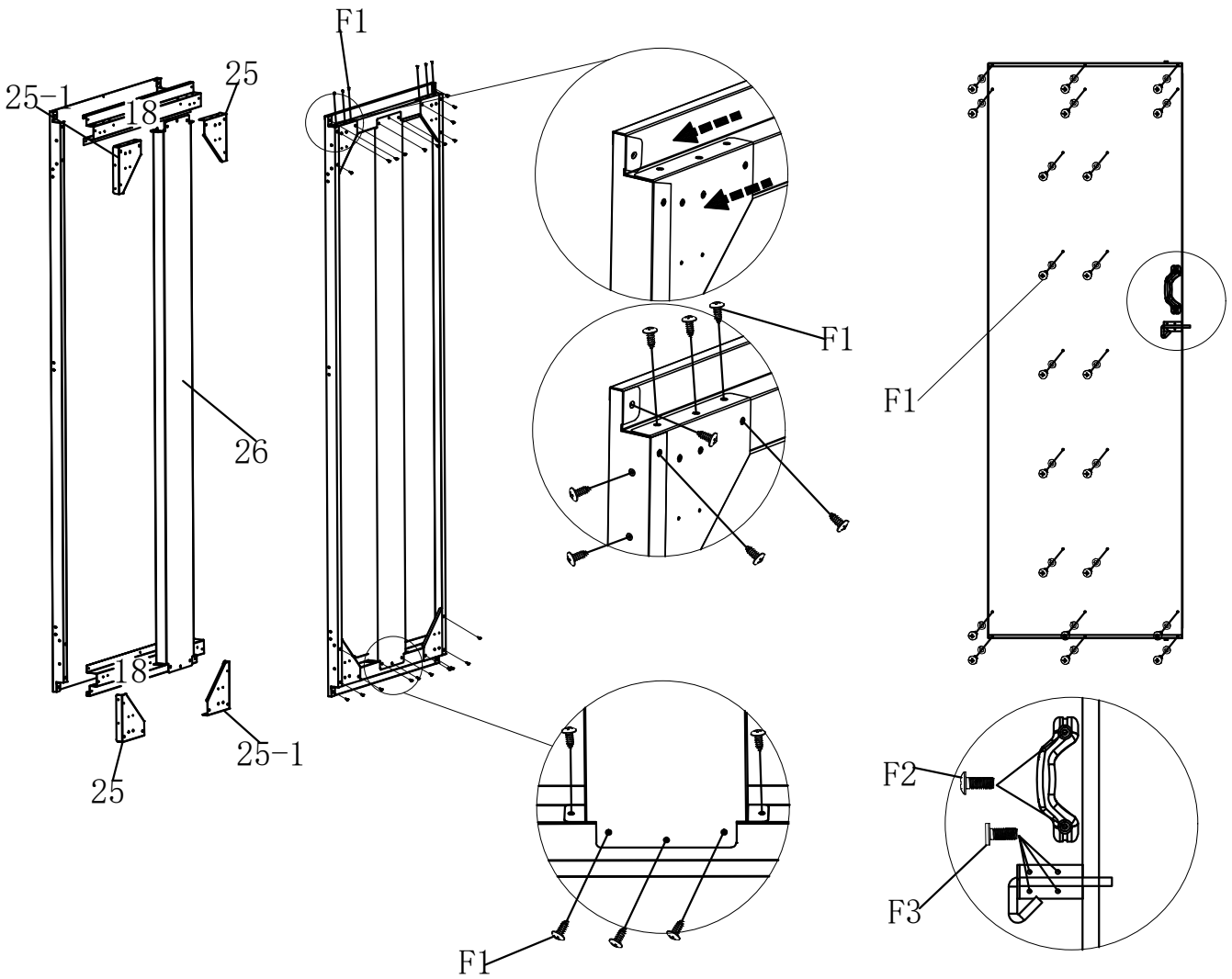

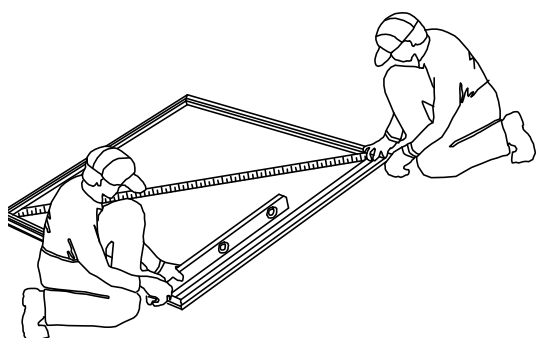
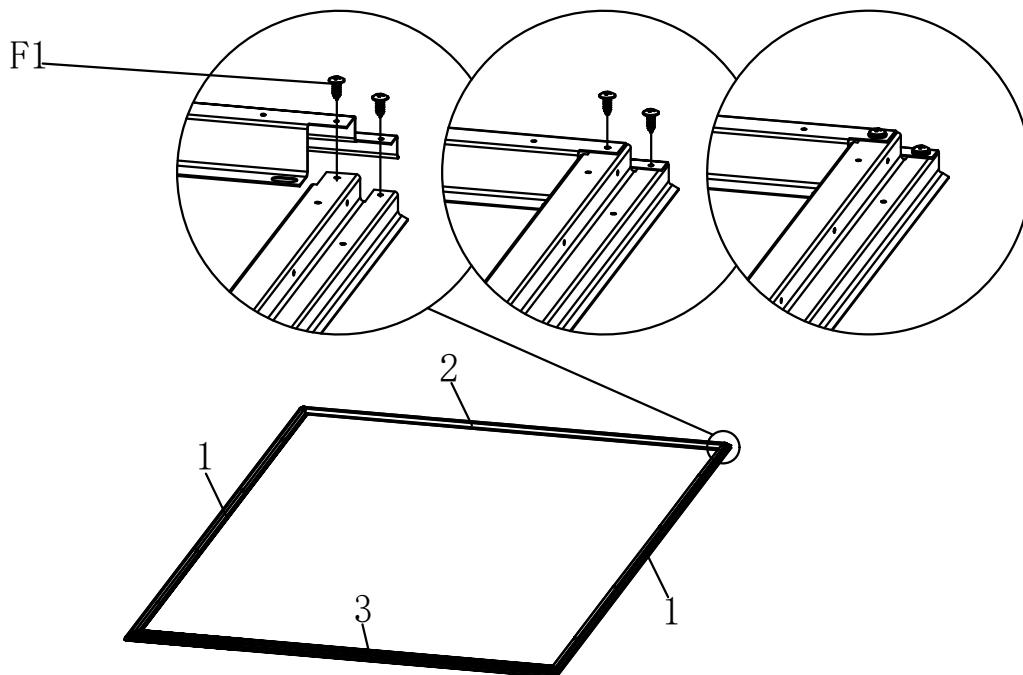
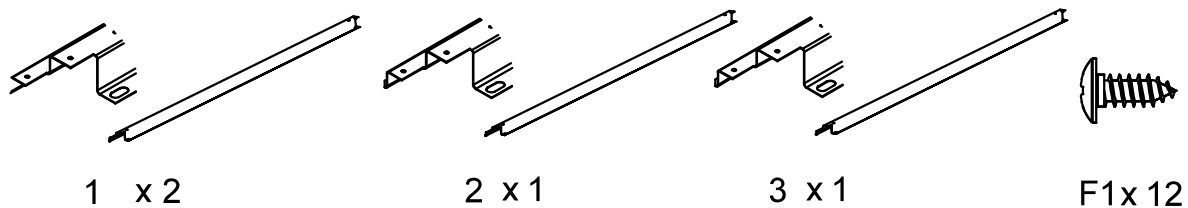

**ES:** Cuando las mediciones diagonales son iguales, el marco es cuadrado. El marco del suelo debe estar cuadrado y nivelado o los agujeros no se alinearán correctamente.

**EN:** When diagonal measurements are equal, the frame is square. The floor frame must be both square and level or the holes will not line up properly.

**PT:** Quando as medidas diagonais são iguais, o quadro é quadrado. A estrutura do piso deve ser quadrada e nivelada ou os furos não serão alinhados corretamente.

**FR:** Quand les dimensions diagonales sont égales, le cadre est carré. Le cadre du terrain doit être à la fois carré et de niveau ou les trous ne s'alignent pas correctement.

**DE:** Wenn die diagonalen Maße gleich sind, ist der Rahmen quadratisch. Der Bodenrahmen muss quadratisch und eben sein, sonst werden die Löcher nicht richtig ausgerichtet.

**GR:** Όταν οι διαγώνιες μετρήσεις είναι ίσες, το πλαίσιο είναι τετράγωνο. Το πλαίσιο του δαπέδου πρέπει να είναι τετράγωνο και επίπεδο, αλλιώς οι οπές δεν θα ευθυγραμμίζονται σωστά.

**SK:** Ak sú rozmery uhlopriečok rovnaké, rám je štvorcový. Podlahový rám musí byť štvorcový a vodorovný, inak sa otvory nezostavia správne.

**HR:** Kad su dijagonale jednake, okvir je kvadratan. Podni okvir mora biti pravokutan i ravan ili se rupe neće ispravno poravnati.



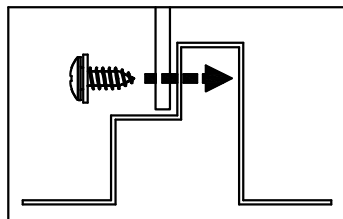
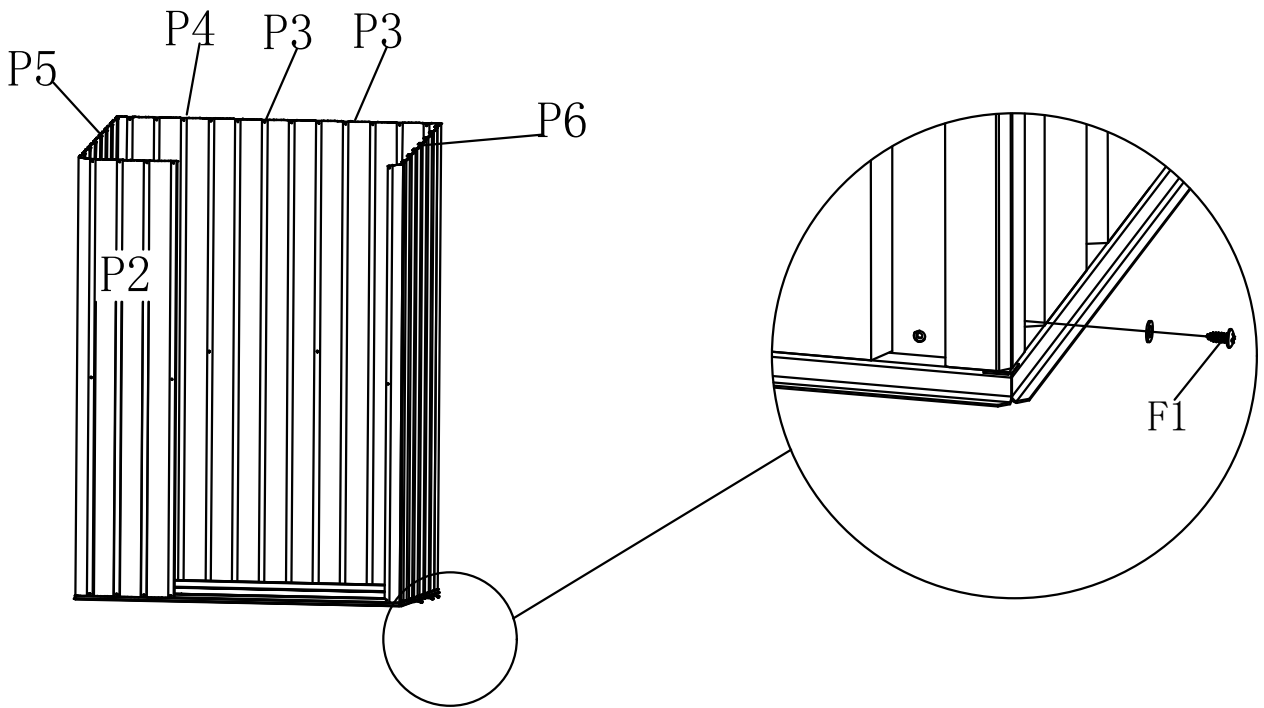
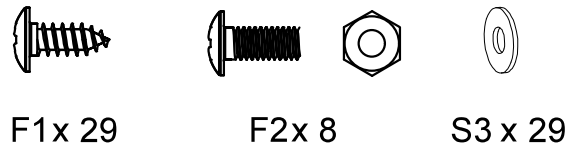
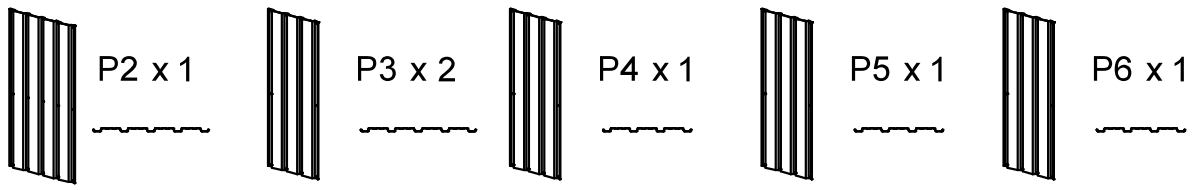

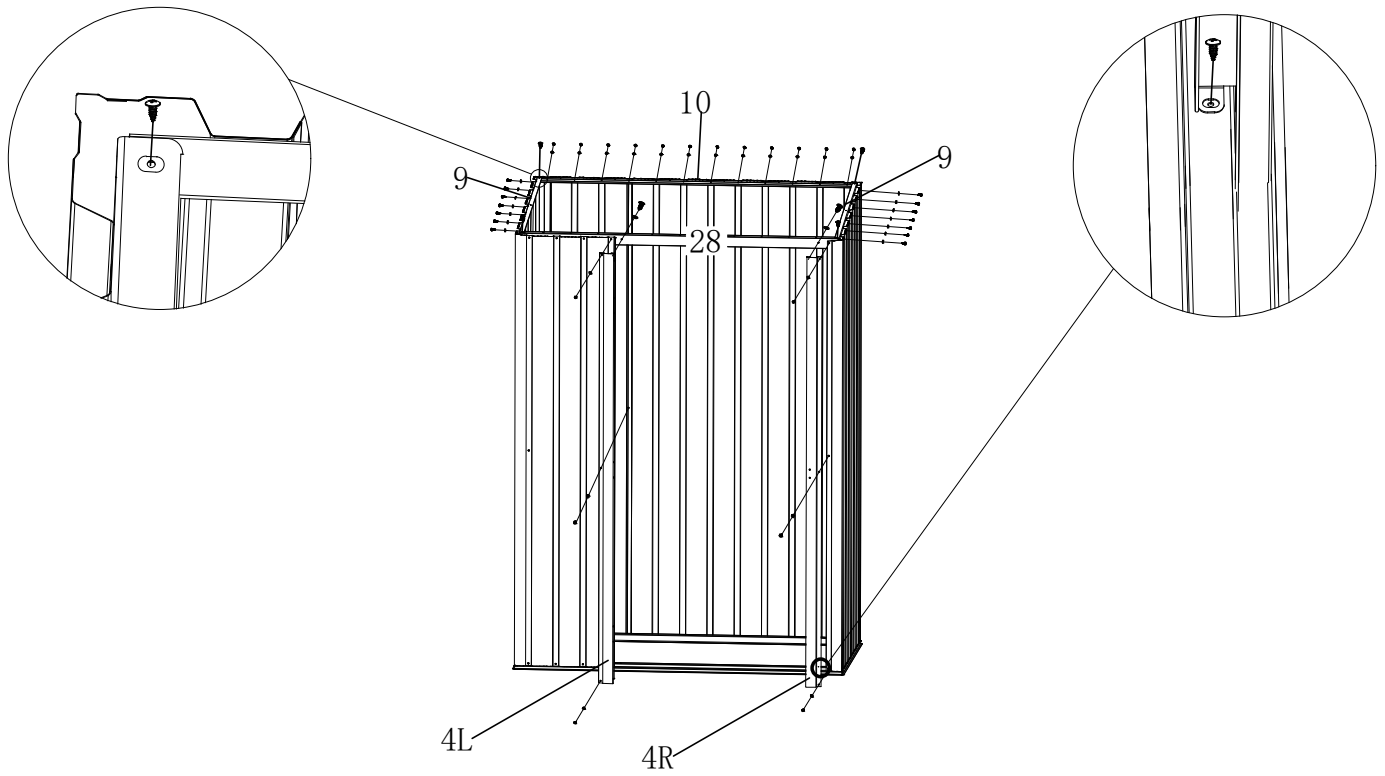
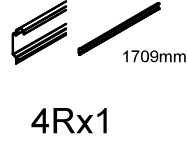
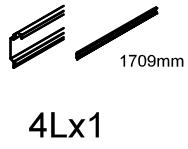
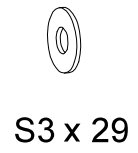
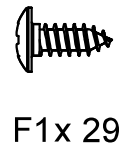
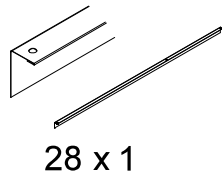
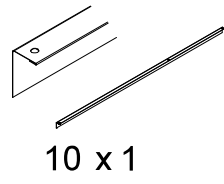
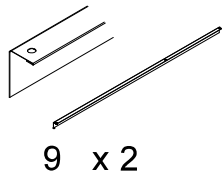

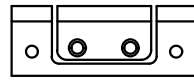
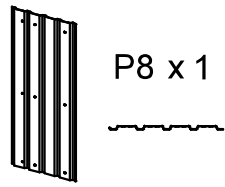
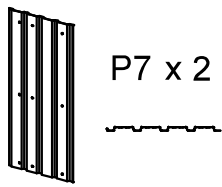

G3x 3



G2x 1

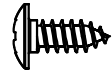

F3 x 4



S3 x 18

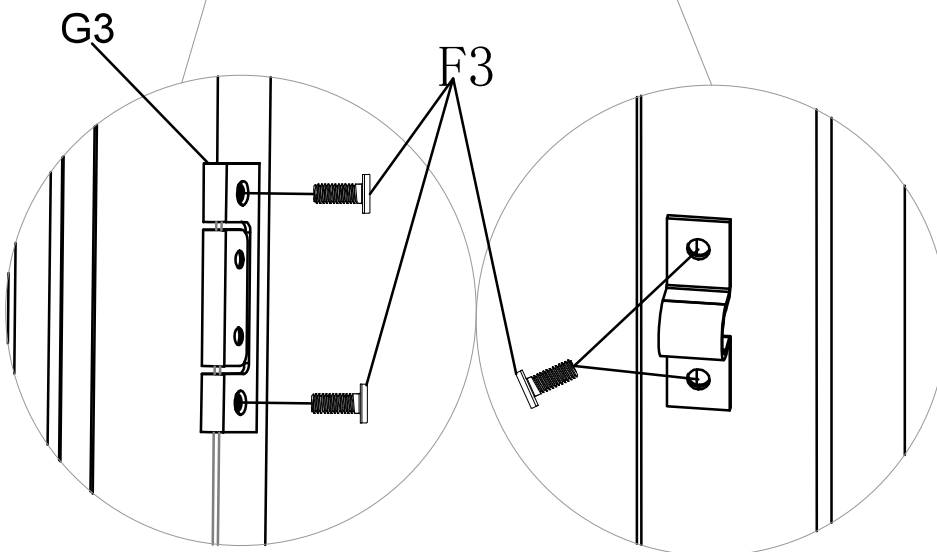
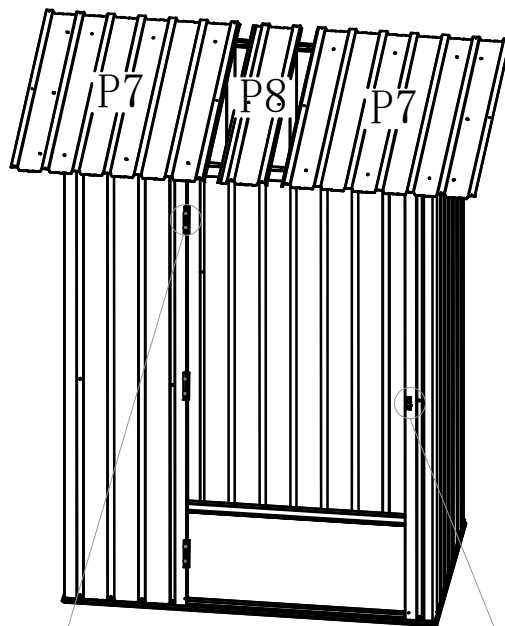

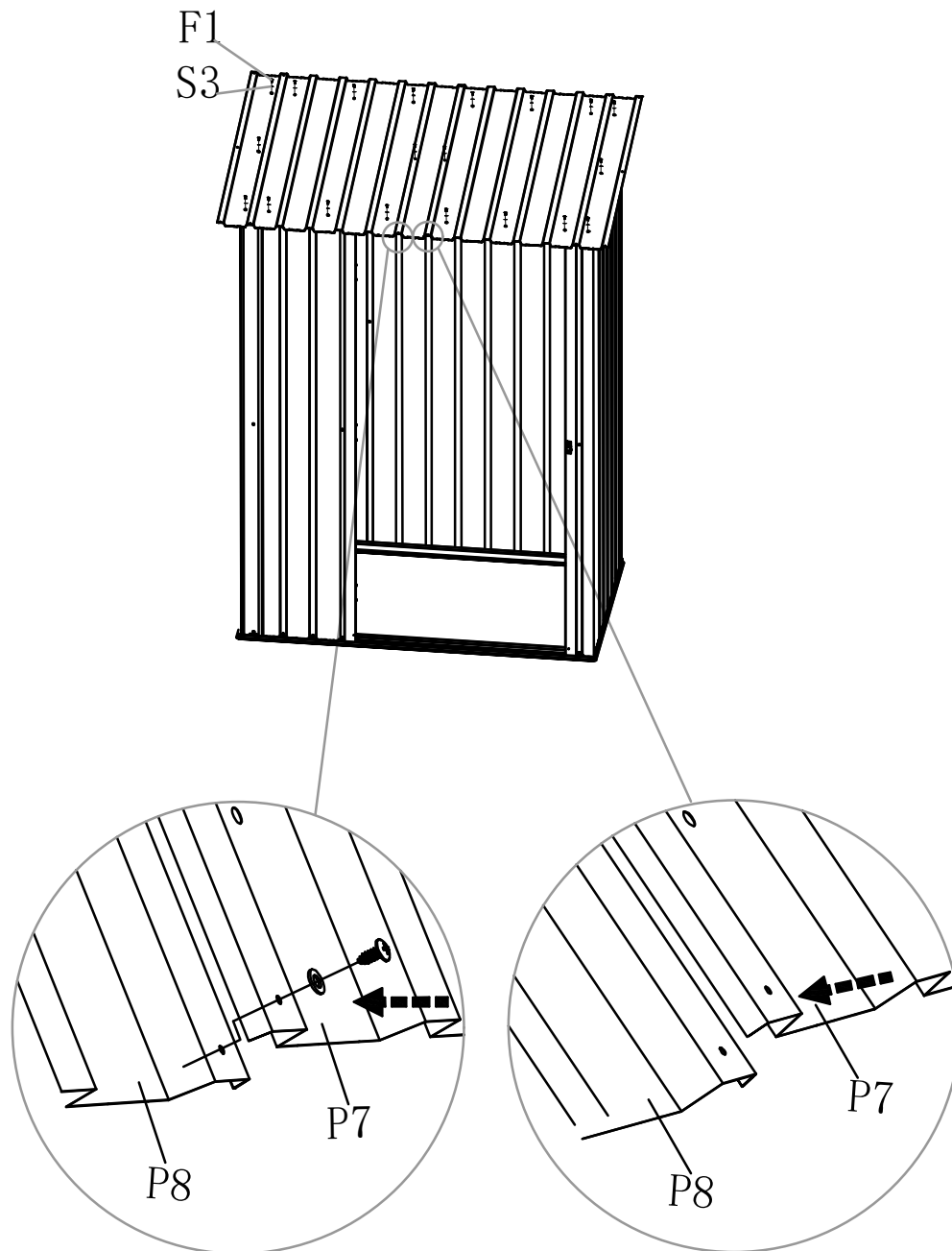

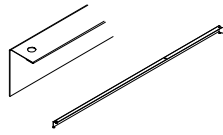

15 x 2

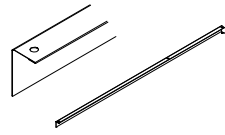

17 x 2

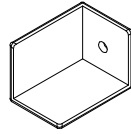

GCx 4

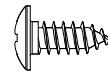

F1x 8



S3x 8

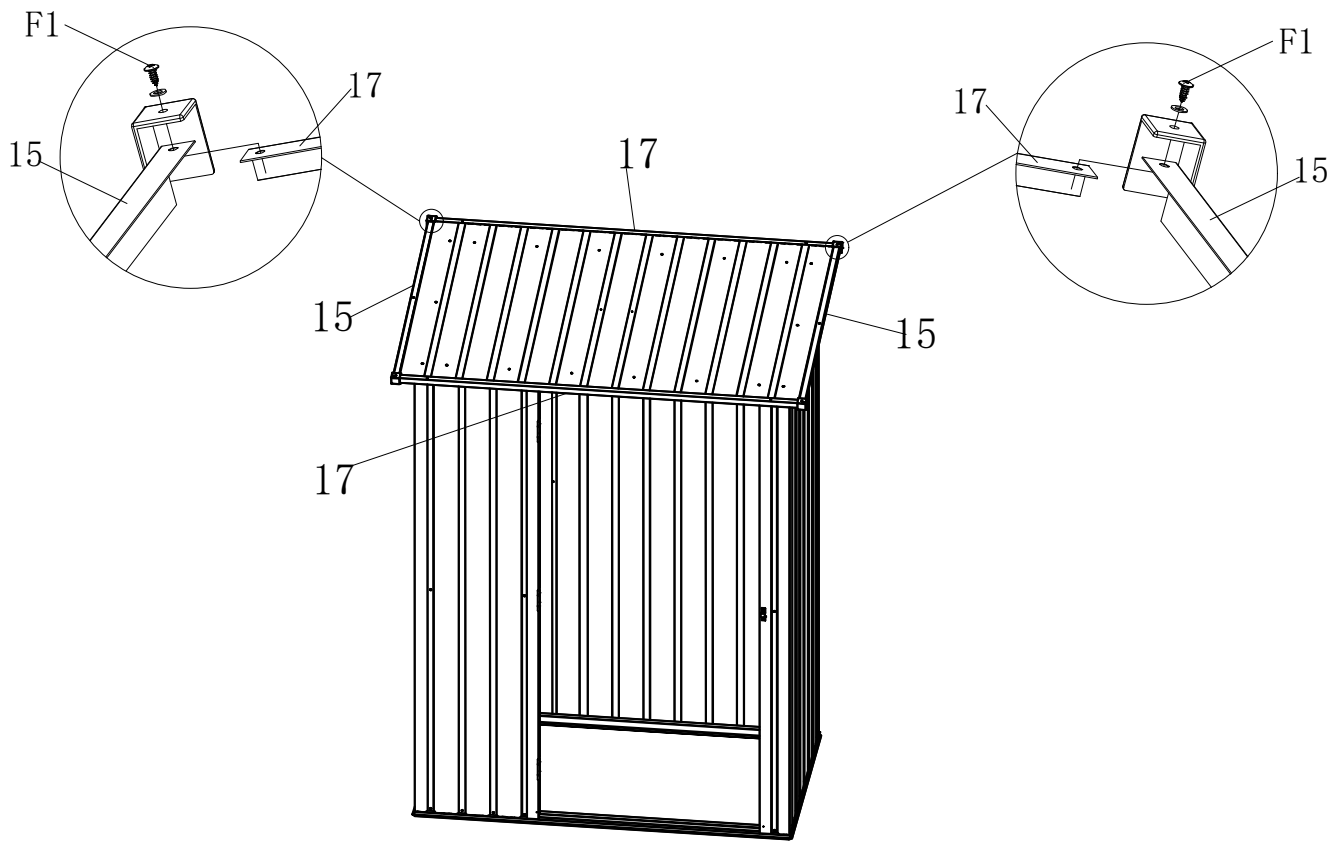

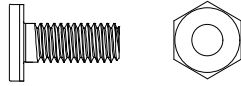

F3 x 6

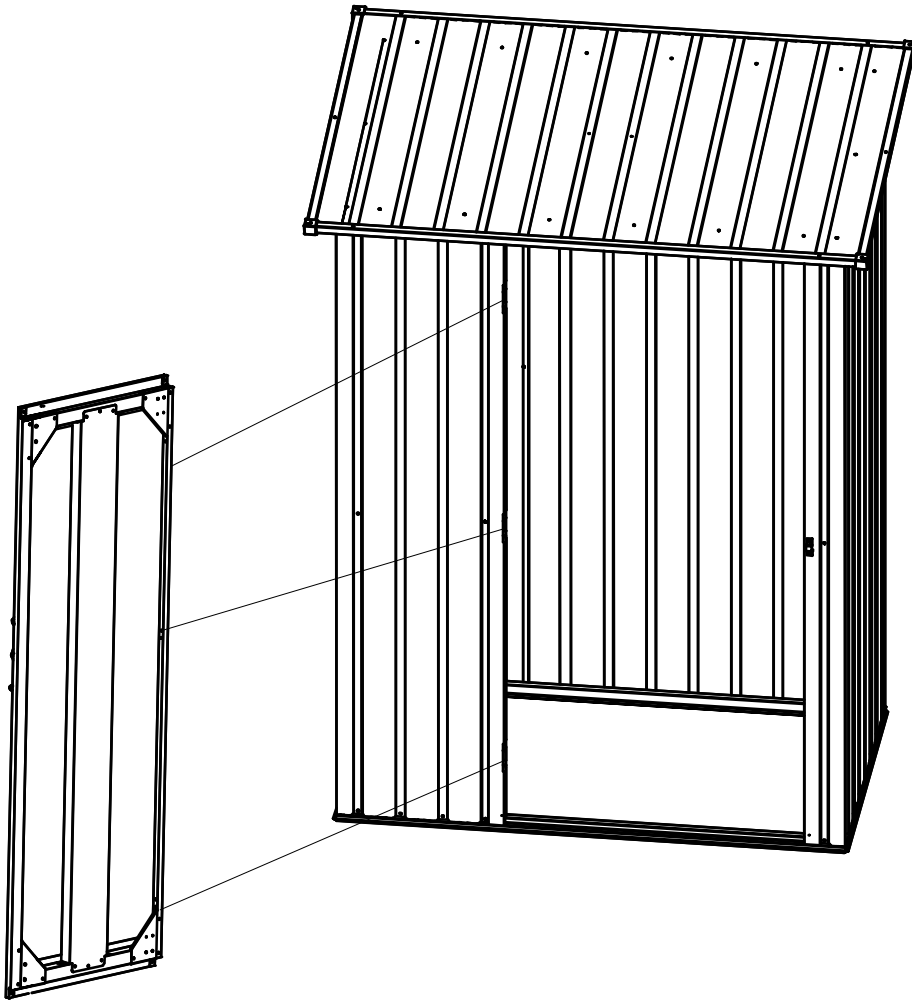

**Thank**   
**you** and  
**congratulations!**





 **Hoggar**<sup>®</sup>

... [hoggargarden.com](http://hoggargarden.com)



OKORU GLOBAL S.L. // Pol. Ind. Barros nº 29. 39408 Barros. Cantabria - España  
(+34) 942 842 170 · info@okoru.es // MADE IN P.R.C.