

Montageanleitung

Duschwanne Nevis

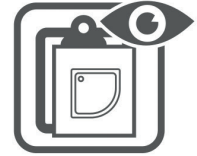

Montagevideo

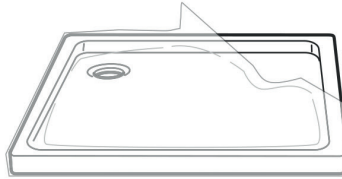

OPTION! (ALTERNATIVE MONTAGE)

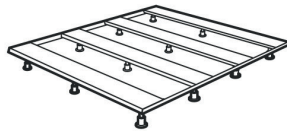

Action icons

0 [Icon: Eye with checkmark] [Icon: Checklist with checkmark] [Icon: Hammer and screwdriver] [Icon: L-shaped corner] [Icon: Drill and screw] [Icon: Bucket and brush] [Icon: Roll of material] [Icon: Clock with 24h] [Icon: Fire with slash]

0 [Icon: Eye with checkmark] [Icon: Checklist with checkmark] [Icon: Hammer and screwdriver] [Icon: L-shaped corner] [Icon: Drill and screw] [Icon: Bucket and brush] [Icon: Roll of material] [Icon: Clock with 24h] [Icon: Fire with slash]

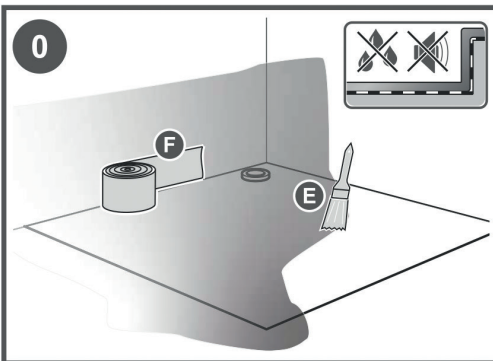

DE Die Montagefläche muss sauber, eben, stabil und ohne Risse sein. Der Aufstellort der Duschwanne und des Ablaufsystems sollte gut abgedichtet werden, z.B. mit einer Flüssigfolie. Dadurch wird ein Überfluten des Bereiches unter der Duschwanne bei Undichtigkeit des Ablaufs verhindert.

EN The mounting surface must be clean, even, stable and without cracks. The place of installation of the shower tray and drainage system should be properly sealed, e.g. with a liquid foil. This prevents flooding of the area under the shower tray in the event of leakage of the drain.

[Icon: Eye with checkmark] [Icon: Checklist with checkmark] [Icon: SILICONE]

X = ~3 mm

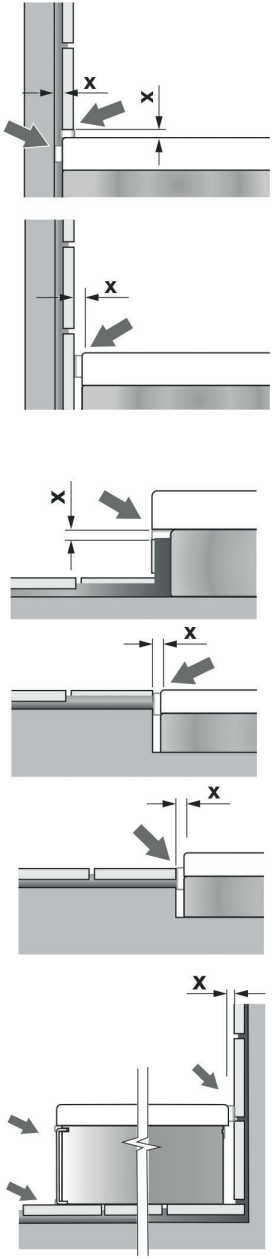

[Icon: Warning triangle] [Icon: Arrow pointing left and right]

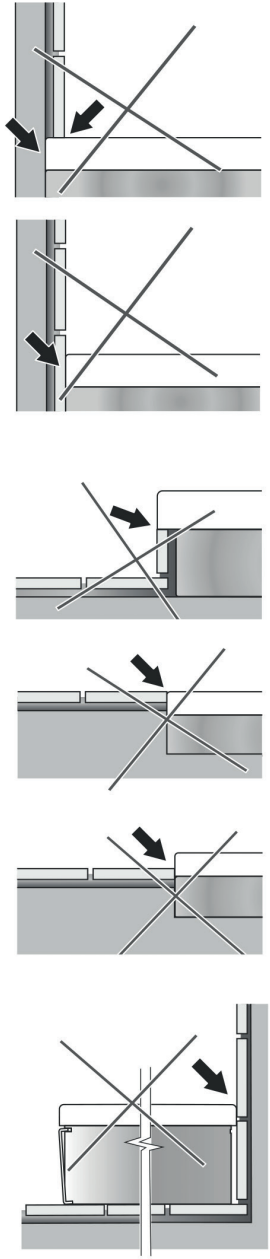

Montageanleitung

Duschwanne Nevis

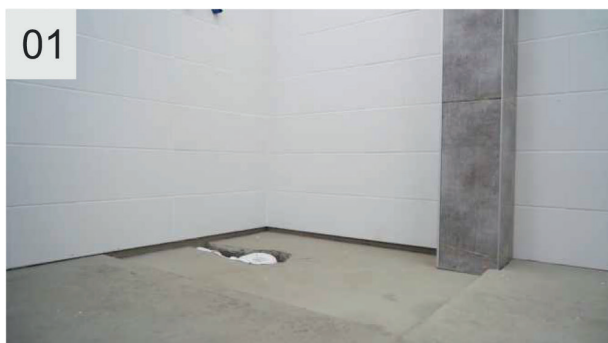

DE kürzbar (> 5 cm)

EN cuttable (> 5 cm)



DE Führen Sie den Schnitt mit einer Stichsäge mit einem Metallschneideblatt durch.

EN Make the cut using a jigsaw with a metal-cutting blade.



DE Sichern Sie den Schnitt mit Dichtmasse.

EN Secure the cut with sealing compound.



Montageanleitung

Duschwanne Nevis



DE Kleben Sie die Duschwanne mit Fliesenkleber oder Baukleber vollflächig auf den Boden.

EN Glue the shower tray to the floor using tile adhesive or construction adhesive spread over the entire surface.

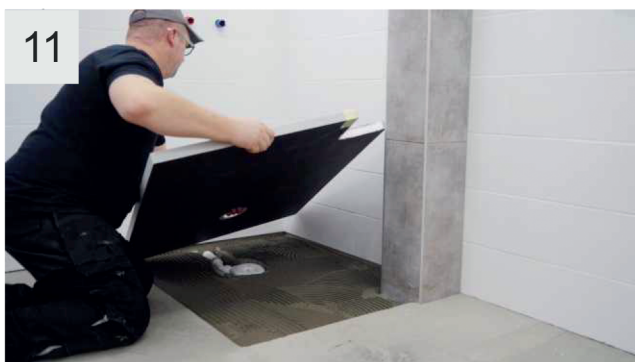

DE Belasten Sie die Duschwanne (mindestens 25 kg) für die Abbindezeit des Klebers.

EN Apply weight to the shower tray (minimum 25kg) while the adhesive is binding.

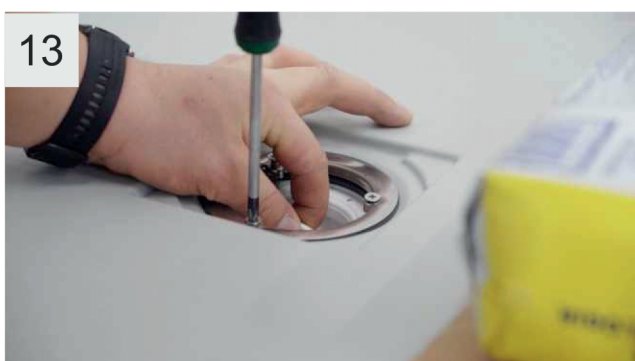

DE Dichten Sie die Fugen zwischen der Duschwanne und den Wänden und dem Boden mit Sanitärsilikon ab.

EN Seal the joints between the shower tray and the walls and floor with sanitary silicone

Alternative Einbaumöglichkeit mit Montagerahmen

Alternative installation on a rack

