

HT-Innenentwässerung

Das komplette Programm. Einfache Steckmontage, deshalb schnell und sauber zu verlegen!

- Rohre und Formstücke für Abwasserleitungen innerhalb von Gebäuden nach DIN EN 1451 - 1
- heißwasserbeständig bis 90°C
- für heiße, kalte und aggressive Abwässer geeignet
- einfache Steckmuffen-Verbindung
- schnell und rationell zu verlegen mit geringem Gefälle
- Nennweiten DN 32/40/50/75/90/110
- Material: schwer entflammables Polypropylen = PP nach DIN 4102/B1
- Farbe: Staubgrau RAL 7037

Toilette

Montage der Abwasserrohre unterhalb der Decke. Spülkasten nicht eingebaut.

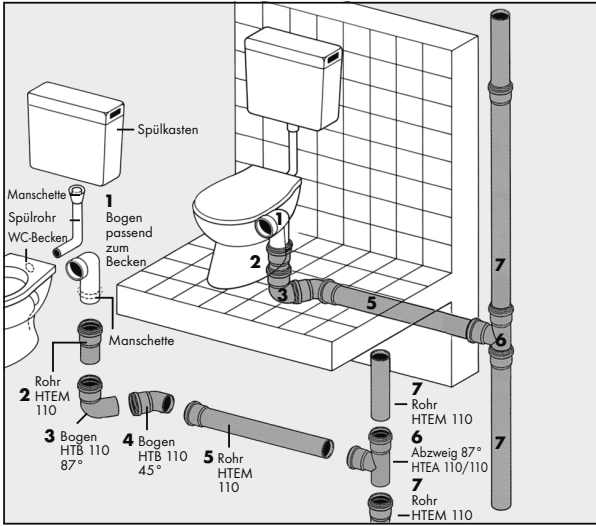

Waschbecken

Verlegung der Abwasserrohre im Mauerschlitze. Anschluss unter der Decke.

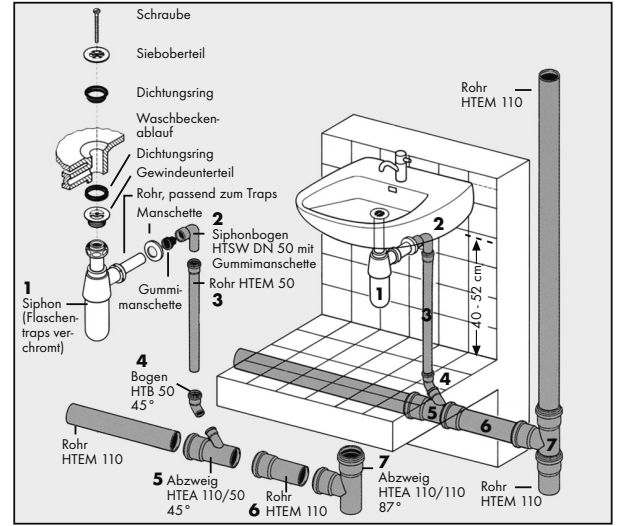

Dusche

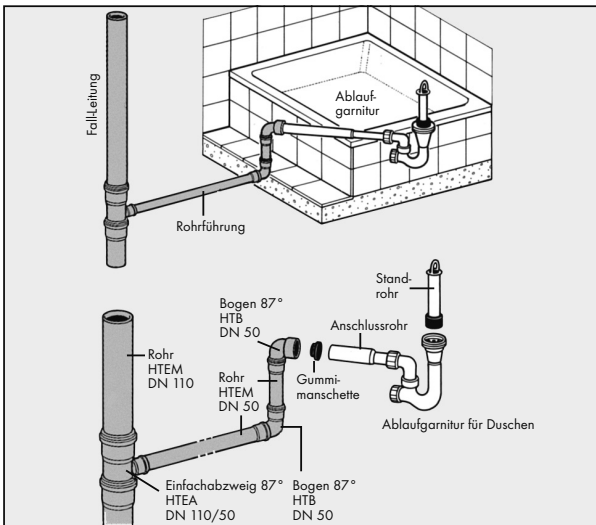

Spüle und Geschirrspüler

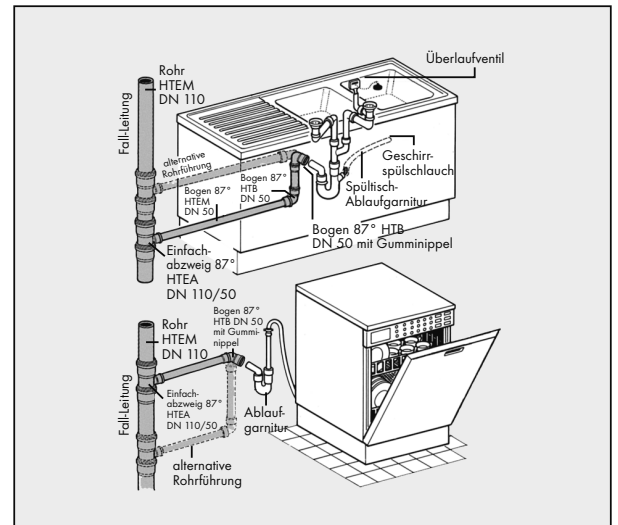









Unseren Produktfilm
HT-Rohrleitungssystem verlegen
 auf Ihrem Smartphone ansehen!

















Weitere Informationen unter
www.marley.de

















Mach's mit Marley.

Marley HT-Innenentwässerung

Das HT-Programm zur einfachen Steckmontage.
Mit vormontierter Lippendichtung.

Artikel	DN	EAN-Nr. 4002644...	Menge
HTEM Rohre mit Steckmuffe 	150 mm	40	090023
		50	090030
		75	090047
		110	090054
		32	090115
	250 mm	40	090122
		50	090139
		75	090146
		90	090160
		110	090153
	500 mm	32	090214
		40	090221
		50	090238
		75	090245
		90	090269
	1100 mm	110	090252
		32	090412
		40	090429
		50	090436
		75	090443
2000 mm	90	090467	
	110	090450	
	32	090818	
	40	090825	
	50	090832	
32	75	090849	
	90	090900	
	110	090856	
	40	091105	
	50	091129	
HTB Bogen 15° 	75	091136	
	90	091143	
	110	091150	
	32	091204	
	40	091228	
HTB Bogen 30° 	50	091235	
	75	091242	
	90	091273	
	110	091259	
	32	091303	
HTB Bogen 45° 	40	091327	
	50	091334	
	75	091341	
	90	091372	
	110	091358	
HTB Bogen 67° 	32	091402	
	40	091426	
	50	091433	
	75	091440	
	90	091471	
HTB Bogen 87° 	110	091457	
	32	091600	
	40	091624	
	50	091631	
	75	091648	
HTEA Einfach-Abzweig 45° 	90	091662	
	110	091655	
	32/32	091709	
	40/40	091716	
	50/40	091723	
	50/50	091730	
	75/50	091754	
	75/75	091761	
	90/50	091679	
	90/75	091686	
90/90	091693		
HTEA Einfach-Abzweig 67° 	110/50	091778	
	110/75	091785	
	110/110	091792	
	40/40	091815	
	50/40	091822	
	50/50	091839	
	75/50	091853	
	75/75	091860	
	110/50	091877	
	110/75	091884	
HTEA Einfach-Abzweig 87° 	110/110	091891	
	32/32	091907	
	40/40	091914	
	50/40	091921	
	50/50	091938	
	75/50	091952	
	90/50	092003	
	90/75	092010	
	90/90	092027	
	75/75	091969	
110/50	091976		
110/75	091983		
110/110	091990		

Artikel	DN	EAN-Nr. 4002644...	Menge
HTDA Doppel-Abzweig 67° 	50/50/50	092126	
	75/75/75	092133	
	110/50/50	092140	
	110/110/110	092164	
	HTDA Doppel-Abzweig 87° 	90/90/90	092188
HTED Eckabzweig 67° 	110/110/110	092171	
	HTR Übergangsrohr exzentrisch 	40/32	092300
HTR Übergangsrohr exzentrisch 	50/32	092317	
	50/40	092324	
	75/50	092348	
	90/50	092270	
	90/75	092287	
	110/50	092355	
	110/75	092362	
110/90	092294		
HTR Übergangsrohr kurz exzentrisch 	110/50	513683	
	110/75	513690	
HTL Langmuffe (2 1/2 fach) 	40	092423	
	50	092430	
	75	092447	
	90	092478	
	110	092454	
HTU Überschiebemuffe 	32	092508	
	40	092522	
HTRE Reinigungsrohr 	50	092539	
	75	092546	
	90	092577	
	110	092553	
	50	092737	
HTM Muffenstopfen 	75	092744	
	90	092775	
	110	092751	
	32	092805	
	40	092829	
HTSW Siphon-Winkel 90° 	50	092836	
	75	092843	
	90	092874	
	110	092850	
	30/30	099293	
HTDSB Doppel-siphon-Bogen 90° 	40/30	092928	
	40/40	092935	
	50/40	092942	
	50/50	092959	
	40/50/40	092966	
HTS Anschlussstück an Metallrohre 	32/32	098791	
	40/40	093024	
	50/40	093031	
	50/50	093048	
	50	093352	
HTUG Anschlussstück an Gussrohre 	75	093369	
	110	093376	
	40	093666	
	50	093673	
	75	093680	
HT-Schelle, mit Gewindestift 8 x 80 mm 	110	093697	
	40	093765	
	50	093772	
	75	093789	
	90	093802	
HT-Schelle schallgedämmt mit Stockschraube, 8 x 80 mm 	110	093796	
	150 g	093963	

Artikel	DN	EAN-Nr. 4002644...	Menge
HTGM Gummimanschette für Siphonbogen 90°, Doppelsiphon und HTS 	für NW 30/30	30/30	094632
	40/30	40/30 A	094649
	40/40	40/30 B	094656
	50/40	40/40 C	094663
	50/50	50/30 D	094670
		50/40 E	094687
		50/50 F	094694
Gumminippel mit Sickenwulst für Metall- oder Bleirohre 	40 - 1 1/4"		094700
	50 - 1 1/4"		094717
	50 - 1 1/2"		094724
Doppeldichtung für Muffen 	50	094731	
	75	094748	
	110	094755	
Ersatz-Lippendichtung (Typ „BL-Ring“) 	32	094809	
	40	094762	
	50	094779	
	75	094786	
	90	094816	
	110	094793	
	250 mm	50	093918
HT-Flexschlauch 	500 mm	50	093925
	750 mm	50	093932
	1000 mm	50	093949
	50	094007	
	75	094014	
HT-Schallschutzschlauch 5 m Reduziert Schallübertragung, verhindert Schwitzwasser, schützt das Abwasserrohr, 4 mm stark 	110	094021	
	32/40/50	093833	
HT-Rohrbelüfter 	75/90/110	093840	
	50	093895	
Einfach-Rückstauverschluss ERV 50 	50	093895	
	50/75/110	093901	
Dunstrohranschluss für Verbindung der Abwasserleitung mit dem Dunstrohr 	110-50	092614	
	110-75	092621	
HT-Innenreduktion zum Anschluss von HT-Rohren DN 50 und DN 75 an Rohrenden DN 110 	24-32/32-40	338064	
	24-32/40-50	338071	
	32-40/40-50	338187	
	40-50/53-63	338286	
	40-50/75-89	338293	
	40-50/100-115	338309	
	75-89/100-115	338101	
	100-115/110-125	338156	
	100-115/121-136	338149	
	110-125/144-160	338163	
Rohrverbinder 	24-32	338088	
	32-40	338194	
	42-50	338316	
	55-65	338118	
	75-89	338231	
	105-120	338262	
	24-32	338088	
Übergang 	32-40	338194	
	42-50	338316	
Kupplung 	55-65	338118	
	75-89	338231	
	105-120	338262	
	40	093055	
	50	093062	
Schlauchtülle Anschluss für Wasch- und Spülmaschinen 	50	093079	
	40	093086	
Schlauchwinkel Anschluss für Wasch- und Spülmaschinen 	50	093079	
	40	093086	
2-fach Anschlusswinkel zum parallelen Anschließen von Waschmaschine und Kondensat-Trockner an eine Abwasserleitung 	50	093093	
	40	515595	
Kondensatablauf zum Anschließen an Heizungen oder Gasthermen 	40	515595	