

GARDEN SHED

Caseta de jardín · Arrumação exterior · Abri de jardim
Gerätehaus · Σπιτάκι · Záhradné domčeky · Vrtne kučice
Zahradní domek · Vrtne hišice

2,57m²



USER'S MANUAL · MANUAL DE INSTRUCCIONES · MANUAL DE INSTRUÇÕES
MANUEL D'INSTRUCTIONS · GEBRAUCHSANWEISUNG · ΕΓΧΕΙΡΙΔΙΟ ΧΡΗΣΤΗ
MANUALE DI ISTRUZIONI · NÁVOD NA POUŽITIE · PRIRUČNIK
NÁVOD K POUŽITÍ · NAVODILA ZA UPORABO



INDEX

Índice - Inhaltsverzeichnis - Indice - Kazalo

| | | | |
|----|--|--------------------------------------|----|
| EN | | User's manual | 04 |
| ES | | Manual de instrucciones | 05 |
| PT | | Manual de instruções | 06 |
| FR | | Manuel d'instructions | 07 |
| DE | | Gebrauchsanweisung | 08 |
| EL | | Εγχειρίδιο χρήστη | 09 |
| IT | | Manuale di istruzioni | 10 |
| SK | | Návod na použitie | 11 |
| HR | | Priručnik | 12 |
| CS | | Návod k použití | 13 |
| SL | | Navodila za uporabo | 14 |

Assembly - Montaje - Montagem
Montage - Συναρμολόγηση
Montaggio - Montáž - Montaža....15

USER'S MANUAL

Before we begin...

We want to thank you for choosing one of our products. The assembly process may require a little patience and time, but don't worry, we are here to encourage you! 😊

Once you are finished think of the satisfaction and pride you will feel when you see your finished work and know that you have done it yourself. Also, by assembling it you are making a contribution to the environment. How? As it is not delivered fully assembled, less packaging is used, which means less waste and less waste. In this way each product takes up less space and therefore you make the most of the means of transport, thus reducing CO² emissions.

Therefore, with this purchase you are making a conscious choice to protect our planet.

So, go ahead and get to work!



Two people are required to assemble the product



The average assembly time can be between 2 hours for the smaller models and 10-12 hours for the larger ones

RECOMMENDATIONS PRIOR TO ASSEMBLY

The product is not designed to be installed directly on the lawn. We recommend mounting on a level and firm wooden base, a flat concrete floor or cemented bricks or blocks.

If a concrete pad is made it is important that it is sloped towards the edges to prevent water ingress.

It is very important to fix the product to the floor. It does not include screws or other parts necessary for anchoring.

MAINTENANCE

The roof must be kept free of debris, as the weight on top can damage your product.

Do not store chemical, combustible and/or corrosive products inside.

WARRANTY

This product is manufactured with the best materials and under strict quality controls and standards. If you detect any problem with the product you have purchased, please contact our customer service department at the telephone number and email address given on the back cover of this instruction manual.

The warranty is valid from the date of purchase that appears on the receipt or invoice, which must be presented in order to make use of the warranty.

The warranty period for this product is 10 years against any inconvenience or failure resulting from structural defect or discolouration.

EXCLUDED FROM THE WARRANTY:

There are certain causes which are excluded from the guarantee, such as:

- > there is a transport non-conformity, the transport agency must be notified within 24 hours of delivery.
- > Breakage or damage caused by inclement weather.
- > Incorrect assembly, incorrect use and the consequences of this.

In addition, you can consult the complete list of these three by scanning the QR on the box.

TOOLS REQUIRED FOR ASSEMBLY



MANUAL DE INSTRUCCIONES

Antes de comenzar...

Queremos agradecerte que hayas elegido una de nuestros productos. El proceso de montaje puede requerir un poco de paciencia y tiempo, pero no te preocupes ¡estamos aquí para animarte! 😊

Una vez que termines piensa en la satisfacción y orgullo que sentirás al ver tu trabajo terminado y saber que lo has hecho tú mismo. Además, al montarlo estás haciendo una contribución al medio ambiente. ¿Cómo? Al no ser entregado completamente armado, se utiliza menos embalaje, lo que significa menos residuos y menos desperdicio. De esta manera cada producto ocupa menos espacio y por lo tanto se aprovecha al máximo los medios de transporte reduciendo de esta manera las emisiones de CO².

Por lo tanto, con esta compra estás haciendo una elección consciente para proteger nuestro planeta.

Ahora sí... ¡Adelante y manos a la obra!



Son necesarias dos personas para el montaje del producto



El tiempo medio de montaje puede estar entre las 2h de los modelos más pequeños a las 10-12h de los más grandes

RECOMENDACIONES PREVIAS AL MONTAJE

El producto no está diseñado para ser instalado directamente sobre el césped. Recomendamos el montaje sobre una base nivelada y firme de madera, un suelo llano de cemento o ladrillos o bloques cementados.

Si se hace una plataforma de cemento es importante que se incline hacia los bordes para evitar la entrada de agua.

Es muy importante fijar el producto al suelo. No incluye tornillos ni otras piezas necesarias para su anclaje.

MANTENIMIENTO

El techo debe mantenerse limpio de residuos, ya que el peso en la parte superior puede deteriorar tu producto.

No guarde productos químicos, combustibles y/o corrosivos en el interior.

GARANTÍA

Este producto está fabricado con los mejores materiales y bajo estrictos controles y estándares de calidad. En caso de detectar algún inconveniente en el producto adquirido, rogamos te pongas en contacto con el servicio de atención al cliente en el teléfono y email que aparecen descritos en la contraportada de este manual de instrucciones.

La garantía es válida a partir de compra que aparece en el ticket o factura, el cual deberá presentarse para hacer uso de la garantía.

El periodo de garantía de este producto es de 10 años contra todo inconveniente o fallo consecuencia de un defecto estructural o decoloración.

QUEDAN EXCLUIDAS DE LA GARANTÍA:

Hay ciertas causas que quedan excluidas de la garantía como:

- > Si existe una no conformidad del transporte, hay que comunicárselo a la agencia de transportes antes de que transcurran 24h desde la entrega.
- > Las roturas o daños generados por inclemencias meteorológicas.
- > El mal montaje, uso incorrecto y consecuencias derivadas de ello.

Además, de estas tres puedes consultar la lista completa en escaneando el QR de la caja.

**HERRAMIENTAS
NECESARIAS PARA
SU MONTAJE**



MANUAL DE INSTRUÇÕES

Antes de começarmos...

Queremos agradecer-lhe por ter escolhido um dos nossos produtos. O processo de montagem pode exigir um pouco de paciência e tempo, mas não se preocupe, estamos aqui para o encorajar! 😊

Quando terminar, pense na satisfação e no orgulho que sentirá quando vir o seu trabalho acabado e souber que foi feito por si. Além disso, ao montá-lo, está a contribuir para o ambiente. Como? Como não é entregue totalmente montado, é utilizada menos embalagem, o que significa menos resíduos e menos desperdício. Desta forma, cada produto ocupa menos espaço e, portanto, aproveita-se ao máximo os meios de transporte, reduzindo assim as emissões de CO².

Portanto, com esta compra, está a fazer uma escolha consciente para proteger o nosso planeta.

Por isso, ponha mãos à obra!



São necessárias duas pessoas para montar o produto



O tempo médio de montagem pode ser de 2 horas para os modelos mais pequenos e de 10 a 12 horas para os modelos maiores

RECOMENDAÇÕES ANTES DA MONTAGEM

O produto não foi concebido para ser instalado diretamente no relvado. Recomenda-se a instalação sobre uma base de madeira nivelada e firme, sobre um pavimento plano de betão ou sobre tijolos ou blocos cimentados.

Se for feita uma base de betão, é importante que esta seja inclinada em direção às extremidades para evitar a entrada de água. É muito importante fixar o produto ao solo. Não inclui parafusos ou outras peças necessárias para a fixação.

MANUTENÇÃO

O teto deve ser mantido livre de detritos, uma vez que o peso em cima pode danificar o seu produto.

Não guardar produtos químicos, combustíveis e/ou corrosivos no interior.

GARANTIA

Este produto é fabricado com os melhores materiais e sob rigorosos controlos e normas de qualidade. Se detetar algum problema com o produto que adquiriu, contacte o nosso serviço de apoio ao cliente através do número de telefone e do endereço de correio eletrónico indicados na contracapa deste manual de instruções.

A garantia é válida a partir da data de compra que consta do recibo ou da fatura, que deve ser apresentada para poder usufruir da garantia.

O período de garantia deste produto é de 10 anos contra qualquer inconveniente ou falha resultante de defeito estrutural ou descoloração.

EXCLUÍDOS DA GARANTIA:

Existem algumas causas que estão excluídas da garantia, tais como:

- > Se houver uma não conformidade de transporte, a agência de transporte deve ser notificada no prazo de 24 horas após a entrega.
- > Quebra ou danos causados por condições climáticas adversas.
- > Montagem incorrecta, utilização incorrecta e respectivas consequências.

Para além disso, pode consultar a lista completa destas três advertências através da leitura do QR na caixa.

**FERRAMENTAS
NECESSÁRIAS
PARA A MONTAGEM**



MANUEL D'INSTRUCTIONS

Avant de commencer...

Nous tenons à vous remercier d'avoir choisi l'un de nos produits. Le processus d'assemblage peut nécessiter un peu de patience et de temps, mais ne vous inquiétez pas, nous sommes là pour vous encourager ! 😊

Une fois que vous aurez terminé, pensez à la satisfaction et à la fierté que vous éprouverez en voyant votre travail terminé et en sachant que vous l'avez fait vous-même. De plus, en l'assemblant, vous contribuez à la protection de l'environnement. Comment ? Comme il n'est pas livré entièrement assemblé, moins d'emballage est utilisé, ce qui signifie moins de déchets et moins de gaspillage. De cette manière, chaque produit prend moins de place et vous exploitez au maximum les moyens de transport, réduisant ainsi les émissions de CO².

Avec cet achat, vous faites donc un choix conscient pour protéger notre planète.

Alors, n'hésitez plus et mettez-vous au travail !



Deux personnes sont nécessaires pour assembler le produit



Le temps de montage moyen peut être de 2 heures pour les petits modèles et de 10 à 12 heures pour les plus grands

RECOMMANDATIONS AVANT L'ASSEMBLAGE

Le produit n'est pas conçu pour être installé directement sur la pelouse. Nous recommandons de l'installer sur une base en bois plane et ferme, sur un sol plat en béton ou sur des briques ou des blocs cimentés.

Si un socle en béton est réalisé, il est important qu'il soit incliné vers les bords afin d'éviter les infiltrations d'eau.

Il est très important de fixer le produit au sol. Les vis et autres éléments nécessaires à l'ancrage ne sont pas inclus.

ENTRETIEN

Le toit doit être maintenu exempt de débris, car le poids qui s'y trouve peut endommager votre produit.

Ne pas stocker de produits chimiques, combustibles et/ou corrosifs à l'intérieur.

GARANTIE

Ce produit est fabriqué avec les meilleurs matériaux et selon des normes et des contrôles de qualité stricts. Si vous constatez un problème quelconque avec le produit que vous avez acheté, veuillez contacter notre service clientèle au numéro de téléphone et à l'adresse électronique indiqués au dos de ce manuel d'instructions.

La garantie est valable à partir de la date d'achat figurant sur le ticket de caisse ou la facture, qui doivent être présentés pour pouvoir bénéficier de la garantie.

La période de garantie de ce produit est de 10 ans contre tout inconvénient ou défaillance résultant d'un défaut structurel ou d'une décoloration.

EXCLUS DE LA GARANTIE:

Certaines causes sont exclues de la garantie:

- > En cas de non-conformité du transport, l'agence de transport doit être informée dans les 24 heures suivant la livraison.
- > Casse ou dommages causés par les intempéries.
- > Un mauvais montage, une mauvaise utilisation et les conséquences qui en découlent.

En outre, vous pouvez consulter la liste complète de ces trois éléments en scannant le QR sur la boîte.

**OUTILS
NÉCESSAIRES À
L'ASSEMBLAGE**



GEBRAUCHSANWEISUNG

Bevor wir beginnen...

Wir möchten Ihnen danken, dass Sie sich für eines unserer Produkte entschieden haben. Der Zusammenbau kann ein wenig Geduld und Zeit erfordern, aber keine Sorge, wir sind hier, um Sie zu unterstützen! 😊

Wenn Sie fertig sind, denken Sie an die Zufriedenheit und den Stolz, den Sie empfinden werden, wenn Sie Ihr fertiges Werk sehen und wissen, dass Sie es selbst gemacht haben. Außerdem leisten Sie durch den Zusammenbau einen Beitrag zum Umweltschutz: Da das Produkt nicht komplett zusammengebaut geliefert wird, wird weniger Verpackung verwendet, was wiederum weniger Abfall bedeutet. Auf diese Weise nimmt jedes Produkt weniger Platz ein, und Sie nutzen die Transportmittel optimal aus, wodurch der CO²-Ausstoß verringert wird.

Mit diesem Kauf treffen Sie also eine bewusste Entscheidung für den Schutz unseres Planeten.

Und jetzt... an die Arbeit!



Für den Zusammenbau des Produkts werden zwei Personen benötigt



Die durchschnittliche Montagezeit kann zwischen 2 Stunden für die kleineren Modelle und 10-12 Stunden für die größeren Modelle liegen

🗨 EMPFEHLUNGEN VOR DER MONTAGE

Das Produkt ist nicht für die direkte Installation auf dem Rasen vorgesehen. Wir empfehlen die Aufstellung auf einer ebenen und festen Holzunterlage, einem flachen Betonboden oder zementierten Ziegeln oder Blöcken.

Bei einer Betonunterlage ist es wichtig, dass sie zu den Kanten hin abgeschrägt ist, um das Eindringen von Wasser zu verhindern. Es ist sehr wichtig, das Produkt auf dem Boden zu befestigen. Schrauben oder andere für die Verankerung notwendige Teile sind nicht im Lieferumfang enthalten.

🔧 WARTUNG

Das Dach muss frei von Ablagerungen gehalten werden, da das Gewicht auf dem Dach Ihr Produkt beschädigen kann. Lagern Sie keine chemischen, brennbaren und/oder ätzenden Produkte im Inneren.

🛡 GARANTIE

Dieses Produkt wird mit den besten Materialien und unter strengen Qualitätskontrollen und -standards hergestellt. Sollten Sie ein Problem mit dem von Ihnen erworbenen Produkt feststellen, wenden Sie sich bitte an unseren Kundendienst unter der auf der Rückseite dieser Bedienungsanleitung angegebenen Telefonnummer und E-Mail-Adresse.

Die Garantie gilt ab dem Kaufdatum, das auf der Quittung oder Rechnung angegeben ist, die zur Inanspruchnahme der Garantie vorgelegt werden muss.

Die Garantiezeit für dieses Produkt beträgt 10 Jahre gegen jegliche Unannehmlichkeiten oder Ausfälle, die auf strukturelle Mängel oder Verfärbungen zurückzuführen sind.

⚙ VON DER GARANTIE AUSGESCHLOSSEN:

Es gibt bestimmte Ursachen, die von der Garantie ausgeschlossen sind, wie zum Beispiel:

- > Wenn ein Transportfehler vorliegt, muss das Transportunternehmen innerhalb von 24 Stunden nach der Lieferung benachrichtigt werden.
- > Bruch oder Beschädigung durch schlechtes Wetter.
- > Unsachgemäße Montage, unsachgemäße Verwendung und die daraus resultierenden Folgen.

Darüber hinaus können Sie die vollständige Liste dieser drei Punkte durch Scannen des QR-Codes auf der Verpackung einsehen.

**FÜR DIE MONTAGE
ERFORDERLICHE
WERKZEUGE**



ΕΓΧΕΙΡΙΔΙΟ ΧΡΗΣΤΗ

Πριν ξεκινήσουμε...

Θέλουμε να σας ευχαριστήσουμε που επιλέξατε ένα από τα προϊόντα μας. Η διαδικασία συναρμολόγησης μπορεί να απαιτεί λίγη υπομονή και χρόνο, αλλά μην ανησυχείτε, είμαστε εδώ για να σας ενθαρρύνουμε! 😊

Μόλις τελειώσετε σκεφτείτε την ικανοποίηση και την υπερηφάνεια που θα νιώσετε όταν θα δείτε το τελικό σας έργο και θα ξέρετε ότι το κάνατε μόνοι σας. Επίσης, με τη συναρμολόγησή του συμβάλλετε στο περιβάλλον. Πώς; Καθώς δεν παραδίδεται πλήρως συναρμολογημένο, χρησιμοποιείται λιγότερη συσκευασία, πράγμα που σημαίνει λιγότερα απορρίμματα και λιγότερα απόβλητα. Με αυτόν τον τρόπο κάθε προϊόν καταλαμβάνει λιγότερο χώρο και επομένως αξιοποιεί στο έπακρο τα μέσα μεταφοράς, μειώνοντας έτσι τις εκπομπές CO².

Επομένως, με αυτή την αγορά κάνετε μια συνειδητή επιλογή για την προστασία του πλανήτη μας.

Προχωρήστε λοιπόν και πιάστε δουλειά!



Για τη συναρμολόγηση του προϊόντος απαιτούνται δύο άτομα



Ο μέσος χρόνος συναρμολόγησης μπορεί να κυμαίνεται μεταξύ 2 ωρών για τα μικρότερα μοντέλα και 10-12 ωρών για τα μεγαλύτερα

☑ ΣΥΣΤΑΣΕΙΣ ΠΡΙΝ ΑΠΟ ΤΗ ΣΥΝΑΡΜΟΛΟΓΗΣΗ

Το προϊόν δεν έχει σχεδιαστεί για να εγκατασταθεί απευθείας στο γκαζόν. Συνιστούμε την εγκατάσταση σε επίπεδη και σταθερή ξύλινη βάση, σε επίπεδο δάπεδο από σκυρόδεμα ή σε τσιμεντοποιημένα τούβλα ή τούβλα.

Εάν γίνει μια τσιμεντένια βάση, είναι σημαντικό να έχει κλίση προς τις άκρες για να αποφευχθεί η εισροή νερού.

Είναι πολύ σημαντικό να στερεωθεί το προϊόν στο δάπεδο. Δεν περιλαμβάνονται βίδες ή άλλα μέρη που είναι απαραίτητα για την αγκύρωση.

🔧 ΣΥΝΤΗΡΗΣΗ

Η οροφή πρέπει να διατηρείται απαλλαγμένη από σκουπίδια, καθώς το βάρος στην κορυφή μπορεί να προκαλέσει ζημιά στο προϊόν σας.

Μην αποθηκεύετε χημικά, εύφλεκτα ή/και διαβρωτικά προϊόντα στο εσωτερικό της.

🔩 ΕΓΓΥΗΣΗ

Αυτό το προϊόν κατασκευάζεται με τα καλύτερα υλικά και κάτω από αυστηρούς ποιοτικούς ελέγχους και πρότυπα. Εάν εντοπίσετε οποιοδήποτε πρόβλημα με το προϊόν που αγοράσατε, παρακαλούμε επικοινωνήστε με το τμήμα εξυπηρέτησης πελατών μας στον αριθμό τηλεφώνου και στη διεύθυνση ηλεκτρονικού ταχυδρομείου που αναφέρονται στο πίσω εξώφυλλο του παρόντος εγχειριδίου οδηγιών χρήσης.

Η εγγύηση ισχύει από την ημερομηνία αγοράς που αναγράφεται στην απόδειξη ή το τιμολόγιο, τα οποία πρέπει να προσκομιστούν για να κάνετε χρήση της εγγύησης.

Η περίοδος εγγύησης για αυτό το προϊόν είναι 10 χρόνια για κάθε ενόχληση ή βλάβη που προκύπτει από δομικό ελάττωμα ή αποχρωματισμό.

⚠ ΕΞΑΙΡΟΥΝΤΑΙ ΑΠΟ ΤΗΝ ΕΓΓΥΗΣΗ:

Υπάρχουν ορισμένες αιτίες που εξαιρούνται από την εγγύηση, όπως:

- > Εάν υπάρχει μη συμμόρφωση κατά τη μεταφορά, το πρακτορείο μεταφοράς πρέπει να ειδοποιηθεί εντός 24 ωρών από την παράδοση.
- > Σπάζιμο ή ζημιά που προκαλείται από δυσμενείς καιρικές συνθήκες.
- > Λανθασμένη συναρμολόγηση, λανθασμένη χρήση και οι συνέπειες αυτής.

Επιπλέον, μπορείτε να συμβουλευτείτε τον πλήρη κατάλογο αυτών των τριών, σαρώνοντας το QR στο κουτί.

ΕΡΓΑΛΕΙΑ ΠΟΥ ΑΠΑΙΤΟΥΝΤΑΙ ΓΙΑ ΤΗ ΣΥΝΑΡΜΟΛΟΓΗΣΗ



MANUALE DI ISTRUZIONI

Prima di iniziare...

Vogliamo ringraziarvi per aver scelto uno dei nostri prodotti. Il processo di assemblaggio può richiedere un po' di pazienza e di tempo, ma non preoccupatevi, siamo qui per incoraggiarvi! 😊

Una volta terminato, pensate alla soddisfazione e all'orgoglio che proverete quando vedrete il vostro lavoro finito e saprete di averlo fatto da soli. Inoltre, assemblandolo, darete un contributo all'ambiente: poiché non viene consegnato completamente assemblato, vengono utilizzati meno imballaggi, il che significa meno rifiuti e meno scarti. In questo modo ogni prodotto occupa meno spazio e quindi si sfruttano al meglio i mezzi di trasporto, riducendo così le emissioni di CO2. Pertanto, con questo acquisto fate una scelta consapevole per proteggere il nostro pianeta.

Quindi, andate avanti e mettetevi al lavoro!



Per assemblare il prodotto sono necessarie due persone



Il tempo medio di montaggio può variare da 2 ore per i modelli più piccoli a 10-12 ore per quelli più grandi

🗨️ RACCOMANDAZIONI PRIMA DEL MONTAGGIO

Il prodotto non è progettato per essere installato direttamente sul prato. Si consiglia l'installazione su una base di legno piana e solida, su un pavimento piatto di cemento o su mattoni o blocchi cementati.

Se si realizza una base in cemento, è importante che sia inclinata verso i bordi per evitare l'ingresso di acqua.

È molto importante fissare il prodotto al pavimento. Non sono incluse viti o altre parti necessarie per l'ancoraggio.

🔧 MANUTENZIONE

Il tetto deve essere mantenuto libero da detriti, poiché il peso sulla parte superiore può danneggiare il prodotto.

Non conservare all'interno prodotti chimici, combustibili e/o corrosivi.

🛡️ GARANZIA

Questo prodotto è realizzato con i migliori materiali e in base a rigorosi controlli e standard di qualità. Se si riscontrano problemi con il prodotto acquistato, si prega di contattare il nostro servizio clienti al numero di telefono e all'indirizzo e-mail riportati sul retro della copertina di questo manuale di istruzioni.

La garanzia è valida a partire dalla data di acquisto riportata sullo scontrino o sulla fattura, che deve essere presentata per usufruire della garanzia.

Il periodo di garanzia per questo prodotto è di 10 anni contro qualsiasi inconveniente o guasto derivante da difetti strutturali o scolorimento.

🚫 ESCLUSE DALLA GARANZIA:

Vi sono alcune cause che sono escluse dalla garanzia, quali:

- > In caso di non conformità dovuta al trasporto, l'agenzia di trasporto deve essere informata entro 24 ore dalla consegna.
- > Rotture o danni causati da intemperie.
- > Montaggio non corretto, uso non corretto e relative conseguenze.

Inoltre, è possibile consultare l'elenco completo di questi tre elementi scansionando il QR sulla scatola.

**STRUMENTI
NECESSARI PER IL
MONTAGGIO**



NÁVOD NA POUŽITIE

Predtým, ako začneme...

Ďakujeme za kúpu jedného z našich produktov. Proces montáže môže vyžadovať trochu trpezlivosti a času, no my sme tu na to, aby sme vám s tým pomohli! 😊

Myslíte na uspokojenie a pýchu, ktorú pocítite pri pohľade na vlastnoručne dokončenú prácu. Navyše, montážou pomáhate životnému prostrediu. Ako? Dodanie čiastočne rozloženého produktu vyžaduje menej obalového materiálu a menej odpadu. Týmto spôsobom sa obmedzuje aj veľkosť produktov, a tým sa prispieva k úplnému využitiu priestoru v dopravných prostriedkoch a zníženiu CO².

Táto kúpa reprezentuje vašu uvedomelú voľbu na ochranu planéty.

Teraz sa už môžete pustiť do práce!



Na montáž produktu sú potrebné dve osoby



Čas montáže sa pohybuje medzi 2 hodinami, v prípade malých modelov, a 10 – 12 hodinami pri najväčších produktoch

ODPORÚČANIA PRED ZAČATÍM MONTÁŽE

Výrobok nie je určený na inštaláciu priamo na trávnik. Odporúčame montáž na rovný a pevný drevený podklad, rovnú podlahu z betónu, tehiel či tvárnic.

Pri stavbe betónového podkladu je dôležité jeho naklonenie smerom k okraju, aby sa vyhlo hromadeniu vody.

Je dôležité pripevniť produkt k podkladu. Balenie neobsahuje skrutky ani iné súčiastky na jeho ukotvenie.

ÚDRŽBA

Udržujte strechu produktu bez záťaže, pretože tá by mohla spôsobiť jej poškodenie.

Vo vnútri produktu neskladujte chemikálie, horľavé a/alebo oxidačné látky.

ZÁRUKA

Tento produkt je vyrobený z najlepších materiálov podľa prísnych kontrol a štandardov kvality. Ak zistíte akékoľvek problémy so zakúpeným výrobkom, obráťte sa na oddelenie služieb zákazníkom na telefónnom čísle a e-mailovej adrese uvedenej na zadnej strane tohto návodu na použitie.

Záruka je platná od dátumu nákupu uvedeného na účtenke alebo faktúre, ktorú je potrebné predložiť na uplatnenie záruky. Záručná doba tohto výrobku je 10 rokov na akékoľvek neprijemnosti alebo poruchy spôsobené konštrukčnou chybou alebo zmenou farby.

SÚ ZO ZÁRUKY VYLÚČENÉ:

Existujú určité príčiny, ktoré sú zo záruky vylúčené, ako napríklad:

- > Ak sa vyskytne nehoda pri preprave, prepravná spoločnosť musí byť informovaná do 24 hodín od doručenia.
- > Rozbitie alebo poškodenie spôsobené nepriaznivým počasím.
- > Nesprávna montáž, nesprávne používanie a ich dôsledky.

Kompletný zoznam týchto prípadov si môžete pozrieť naskenovaním kódu QR na škatuli.

**NÁRADIE
POTREBNÉ NA
MONTÁŽ**



PRIRUČNIK

Prije no što započnete...

Hvala vam što ste odabrali jedan od naših proizvoda. Za proces montaže možda je potrebno nešto strpljenja i vremena, ali ne brinite se: ovdje smo da vam pomognemo! 😊

Pomislite na zadovoljstvo i ponos koje ćete osjetiti kad završite i vidite da je vaš posao gotov i da ste ga sami napravili. Osim toga, montažom pomažete okolišu. Kako? S obzirom na to da se ne isporučuje u gotovom stanju, troši se manje ambalaže, što znači manje otpadaka i smeća. Na ovaj način svaki proizvod zauzima manje prostora, zbog čega se prijevozna sredstva maksimalno iskorištavaju, čime se smanjuje emisija CO².

Stoga vi ovom kupnjom svjesno odlučujete zaštititi naš planet.

A sada... Na posao!



Za montažu proizvoda potrebne su dvije osobe



Prosječno vrijeme montaže može biti od 2 h za najmanje modele do 10-12 h za najveće

PREPORUKE PRIJE MONTAŽE

Proizvod nije namijenjen za travnjak kao izravnu podlogu. Preporučujemo montažu na čvrstoj, ravnoj drvenoj podlozi, ravnoj betonskoj podlozi ili podlozi od cementiranih opeka ili ploča.

Ako se radi betonska platforma važno je da ona ima nagib prema rubovima kako bi se izbjegao prodor vode.

Vrlo je važno pričvrstiti proizvod za pod. Nisu uključeni vijci ni drugi dijelovi potrebni za pričvršćivanje.

ODRŽAVANJE

Krov se mora čistiti od otpadaka jer težina u gornjem dijelu može oštetiti vaš proizvod.

Unutra nemojte skladištiti kemijske, zapaljive i/ili korozivne proizvode.

JAMSTVO

Ovaj proizvod izrađen je od vrhunskih materijala i pod strogim kontrolama i standardima kvalitete. U slučaju bilo kakvih mana na kupljenom proizvodu, obratite se službi za kupce na broj telefona i e-mail koji su navedeni na poledini ovog priručnika za uporabu.

Jamstvo vrijedi od datuma kupnje koji se nalazi na potvrdi ili računu koji je potrebno predočiti za korištenje jamstva.

Razdoblje jamstva za ovaj proizvod je 10 godina za bilo kakve neugodnosti ili kvarove koji su rezultat strukturnog oštećenja ili promjene boje.

U JAMSTVO NISU UKLJUČENI:

Neki uzroci nisu uključeni u jamstvo, kao:

- > U slučaju neadekvatnog transporta, treba obavijestiti agenciju za prijevoz prije no što prođu 24 sata od isporuke.
- > Lomovi ili oštećenja uzrokovani vremenskim nepogodama.
- > Loša montaža, nepravilna uporaba i njihove posljedice.

Osim ova tri, možete pregledati cijeli popis skeniranjem QR koda na kutiji.

**ALAT POTREBAN
ZA MONTAŽU**



NÁVOD K POUŽITÍ

Než začnete...

Chtěli bychom vám poděkovat, že jste si vybrali jeden z našich produktů. Montáž může vyžadovat trochu trpělivosti a času, ale nebojte se, jsme tu, abychom vám pomohli! 😊

Představte si, jaké uspokojení a hrdost pocítíte, až uvidíte produkt smontovaný a budete vědět, že jste jej smontovali vy sami. Navíc tím šetříte i životní prostředí. Proč? Díky tomu, že produkty nejsou dodávány kompletně smontované, spotřebovává se méně obalů, což znamená méně odpadu a zbytků. Každý výrobek tak zabírá méně místa a proto se dopravní prostředky maximálně využijí, čímž se snižují emise CO².

Tímto nákupem se tedy vědomě rozhodujete chránit naši planetu.

Tak a nyní... Jdeme na to!



**K sestavení produktu
jsou zapotřebí dvě osoby**



**Průměrná doba montáže může být 2
hodiny u nejmenších modelů a 10-12
hodin u největších**

🗨️ DOPORUČENÍ PŘED MONTÁŽÍ

Výrobek není určen k instalaci přímo na trávnik. Doporučujeme jej umístit na pevný a rovný dřevěný podklad, rovnou cementovou podlahu nebo tmelené cihly či bloky.

Pokud se jedná o cementovou plošinu, je důležité, aby se svažovala směrem k okrajům, aby se zabránilo vniknutí vody.

Je velmi důležité připevnit výrobek k zemi. Neobsahuje šrouby ani jiné díly nutné k jeho ukotvení.

🔧 ÚDRŽBA

Na střeše nesmí zůstat žádné předměty, protože její zatížení by mohlo poškodit váš produkt.

Neskladujte uvnitř chemické, hořlavé ani korozivní produkty.

🛡️ ZÁRUKA

Tento produkt je vyroben z nejlepších materiálů a byl podroben přísné kontrole kvality a norem. V případě, že u zakoupeného produktu zjistíte jakékoliv závady, kontaktujte prosím zákaznický servis na telefonním čísle a emailu, které jsou uvedeny na zadní straně tohoto návodu.

Záruka je platná od data nákupu uvedeného na stvrzence nebo faktuře, kterou je nutné předložit pro její uplatnění.

Záruční doba tohoto výrobku je 10 let na případné nepřijemnosti nebo poruchy způsobené konstrukční vadou nebo změnou barvy.

⚙️ ZÁRUKA SE NEUPLATŇUJE V NÁSLEDUJÍCÍCH PŘÍPÁDECH:

Existují určité případy, kdy záruku nelze uplatnit, například:

- > V případě, že nejste spokojeni s přepravou, je nutné tuto skutečnost oznámit přepravní kanceláři do 24 hodin od doručení.
- > Při rozbití nebo poškození způsobeného nepřízní počasí
- > V případě špatného provedení montáže, nesprávného použití a z toho vyplývajících důsledků.

Kromě těchto tří důvodů existují další, jejichž kompletní seznam si můžete přečíst po naskenování QR kódu na krabici.

**NÁŘADÍ POTŘEBNÉ
K MONTÁŽI**



NAVODILA ZA UPORABO

Pred začetkom...

Želimo se vam zahvaliti, ker ste izbrali enega od naših izdelkov. Postopek montaže bo morda zahteval nekaj potrpljenja in časa, a ne skrbite, tukaj smo, da vam pomagamo! 😊

Ko končate z montažo, pomislite na zadovoljstvo in ponos, ki ju boste občutili, ko boste videli svoje delo dokončali in vse naredili sami. Poleg tega z montažo pozitivno prispevate k okolju. Kako? Ker izdelek ni dostavljen popolnoma montiran, se porabi manj embalaže, kar pomeni manj ostankov in manj odpadkov. Na ta način vsak izdelek zasede manj prostora in je zato prevozno sredstvo kar se da izkoriščeno, s čimer se zmanjšajo emisije CO².

Zato ste se s tem nakupom zavestno odločili za zaščito našega planeta.

Zdaj pa ... Kar na delo!



Za montažo izdelka sta potrebni dve osebi



Povprečni čas montaže je lahko med 2 urama za manjše modele in 10-12 ur za največje modele

PRIPOROČILA PRED MONTAŽO

Izdelek ni zasnovan za namestitvev neposredno na trato. Priporočamo, da se montaža opravi na trdni, ravni leseni podlagi, ravnih cementnih tleh ali na cementiranih opekah ali blokih.

Če se izdelka cementna ploščad, je pomembno, da je nagnjena proti robovom, da se prepreči udor vode.

Zelo pomembno je, da izdelek pritrdite na tla. Ne vključuje vijakov ali drugih delov, potrebnih za njegovo pritrditev.

VZDRŽEVANJE

Na strehi ne sme biti ostankov, saj lahko njihova teža uniči vaš izdelek.

V notranjosti ne shranjujte kemičnih, gorljivih in/ali jedkih izdelkov.

GARANCIJA

Ta izdelek je narejen iz najboljših materialov ter pod strogimi nadzori in standardi glede kakovosti. V primeru, da pri kupljenem izdelku zaznate kakršne koli nevspečnosti, se obrnite na službo za pomoč strankam ter pokličite na telefonsko številko ali pišite na e-poštni naslov, ki sta navedena na zadnji platnici teh navodil za uporabo.

Garancija velja od datuma nakupa, ki je naveden na računu, ki ga morate predložiti za uveljavljanje garancije.

Garancijski rok za ta izdelek je 10 let za morebitne nevspečnosti ali okvare zaradi strukturnih napak ali spremembe barve.

IZ GARANCIJE JE IZVZETO NASLEDNJE:

Obstajajo določeni vzroki, ki so izključeni iz garancije, kot so:

- > Če pride do neskladij pri prevozu, je treba o tem obvestiti prevoznika v 24 urah po dostavi izdelka.
- > Zlomi ali poškodbe zaradi neugodnih vremenskih razmer
- > Slaba montaža, nepravilna uporaba in posledice, ki izhajajo iz tega.

Poleg teh treh vzrokov si lahko ogledate celoten seznam tako, da skenirate kodo QR na škati.







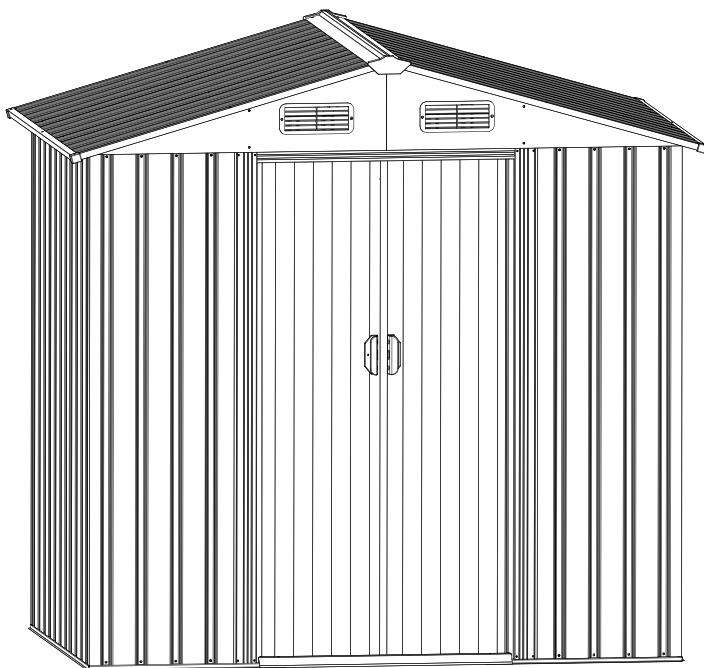

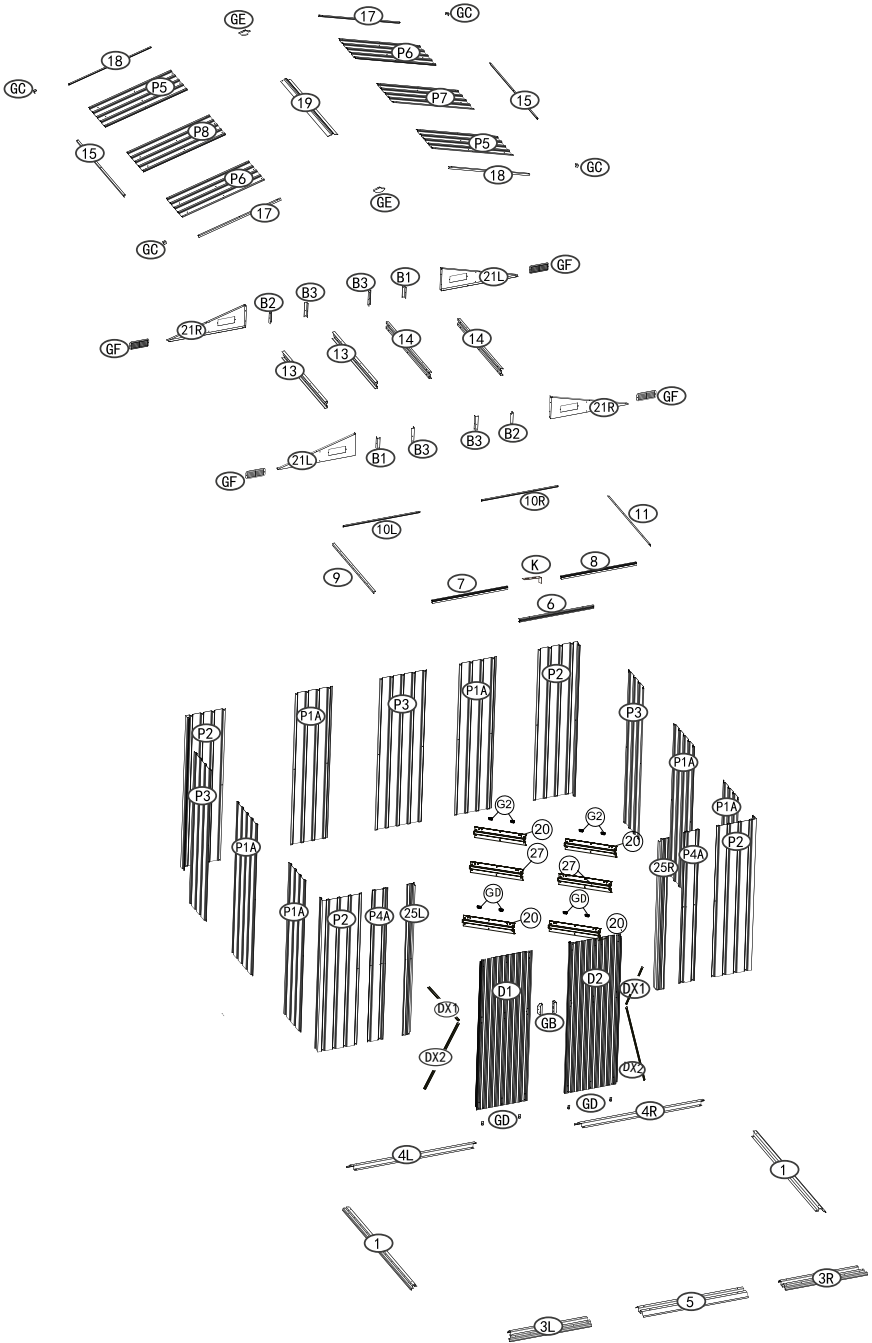











**ORODJE,
POTREBNO ZA
MONTAŽO**

































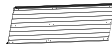

👁 ASSEMBLY · MONTAJE · MONTAGEM · MONTAGE · ΣΥΝΑΡΜΟΛΟΓΗΣΗ
MONTAGGIO · MONTÁŽ · MONTÁŽA









| NO. | PART | Qty. |
|-----|---|------|
| 1 |  | 2 |
| 3L |  | 1 |
| 3R |  | 1 |
| 4L |  | 1 |
| 4R |  | 1 |
| 5 |  | 1 |
| 6 |  | 1 |
| 7 |  | 1 |
| 8 |  | 1 |
| 9 |  | 1 |
| 10L |  | 1 |
| 10R |  | 1 |
| 11 |  | 1 |
| 15 |  | 2 |
| 17 |  | 2 |
| 18 |  | 2 |
| 19 |  | 1 |
| 20 |  | 4 |
| 21L |  | 2 |
| 21R |  | 2 |

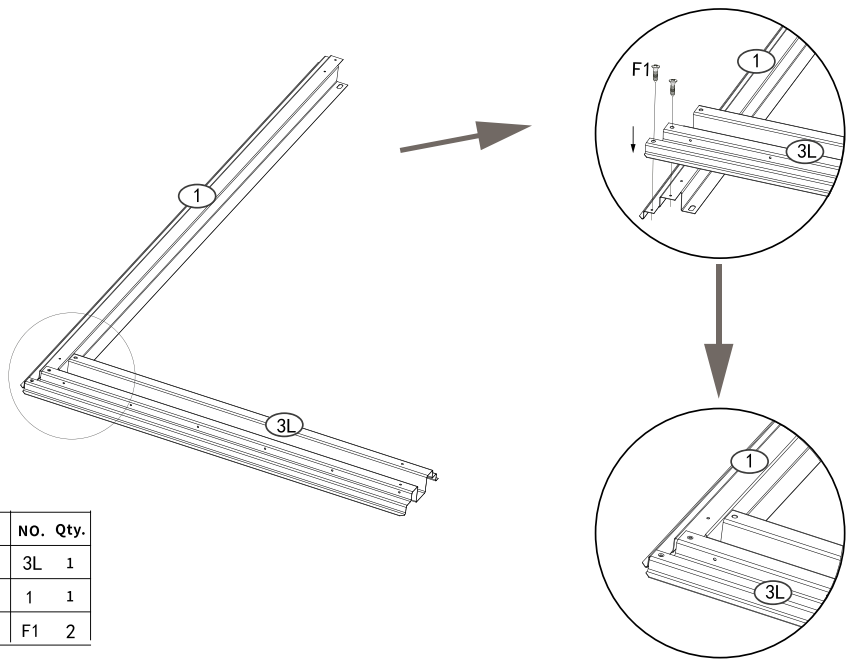

| NO. | PART | Qty. |
|-----|---|------|
| 25L |  | 1 |
| 25R |  | 1 |
| 27 |  | 2 |
| P4A |  | 2 |
| P2 |  | 4 |
| P1A |  | 6 |
| P3 |  | 3 |
| P5 |  | 2 |
| P6 |  | 2 |
| P7 |  | 1 |
| P8 |  | 1 |
| B1 |  | 2 |
| B2 |  | 2 |
| B3 |  | 4 |
| 13 |  | 2 |
| 14 |  | 2 |
| GE |  | 2 |
| GC |  | 4 |
| GF |  | 4 |
| G2 |  | 4 |

| NO. | PART | Qty. |
|------------|---|----------|
| GB |  | 2 |
| D1 |  | 1 |
| D2 |  | 1 |
| GD |  | 4 |
| K |  | 1 |
| F1 |  | 194 |
| F2 |  | 85 |
| S2 |  | 288 |
| F3 |  | 8 |
| S1 |  | 142 |
| DX1 |  | 2 |
| DX2 |  | 2 |



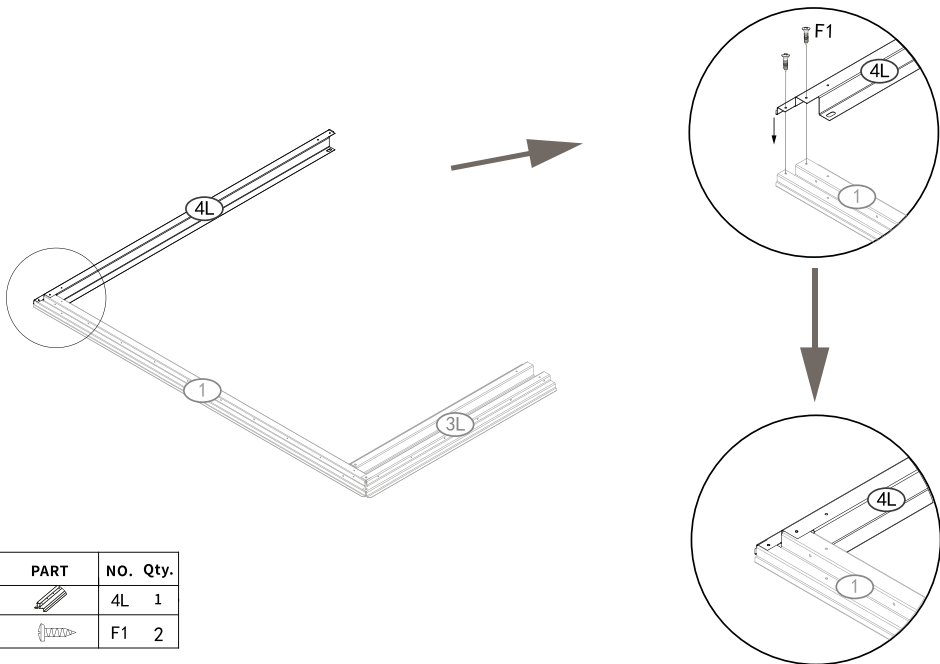

| PART | NO. | Qty. |
|--|-----|------|
|  | 3L | 1 |
|  | 1 | 1 |
|  | F1 | 2 |



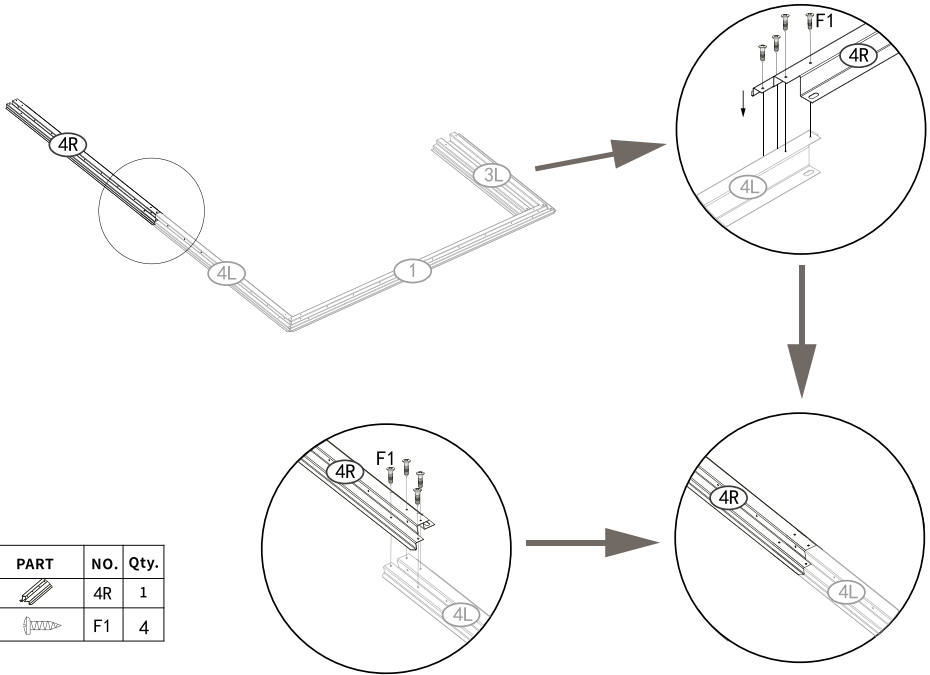

| PART | NO. | Qty. |
|--|-----|------|
|  | 4L | 1 |
|  | F1 | 2 |



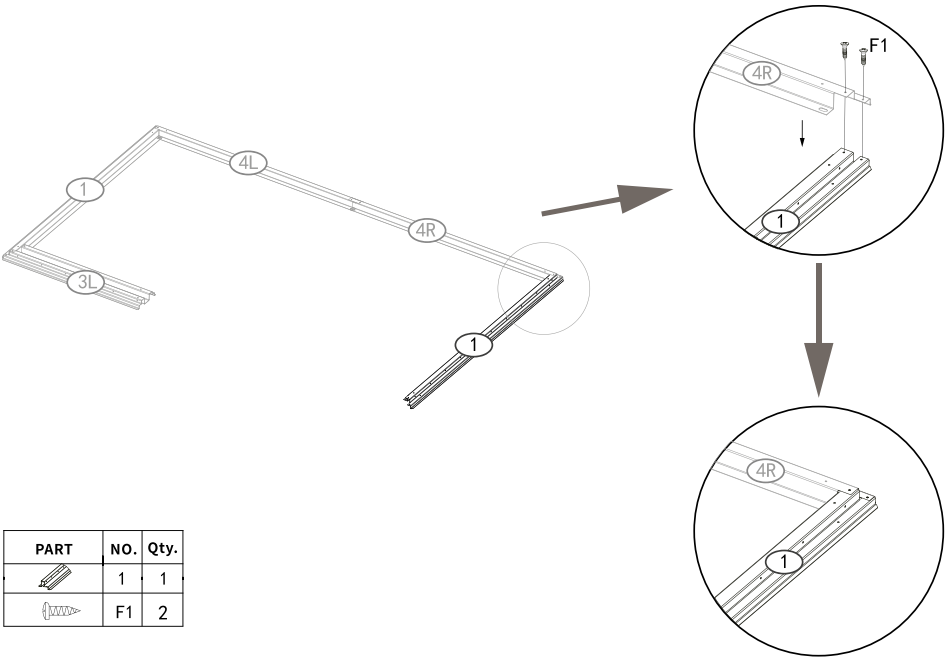

| PART | NO. | Qty. |
|---|-----|------|
|  | 4R | 1 |
|  | F1 | 4 |



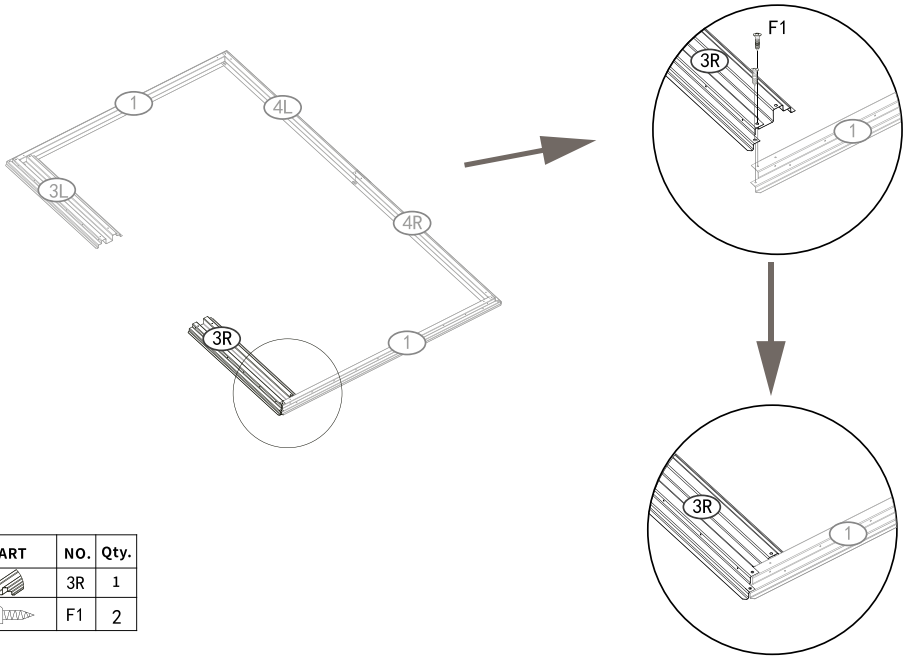

| PART | NO. | Qty. |
|---|-----|------|
|  | 1 | 1 |
|  | F1 | 2 |



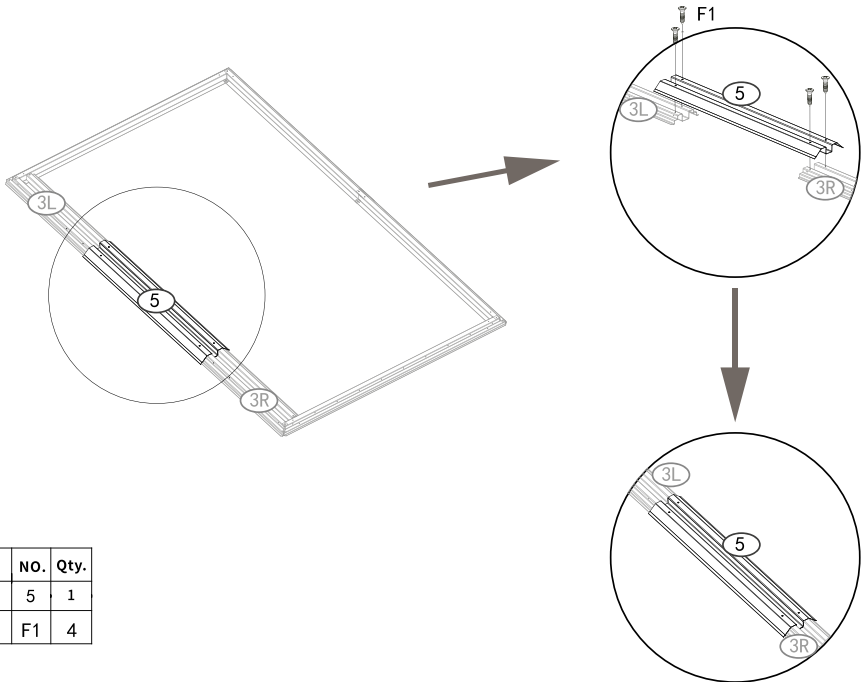

| PART | NO. | Qty. |
|---|-----|------|
|  | 3R | 1 |
|  | F1 | 2 |



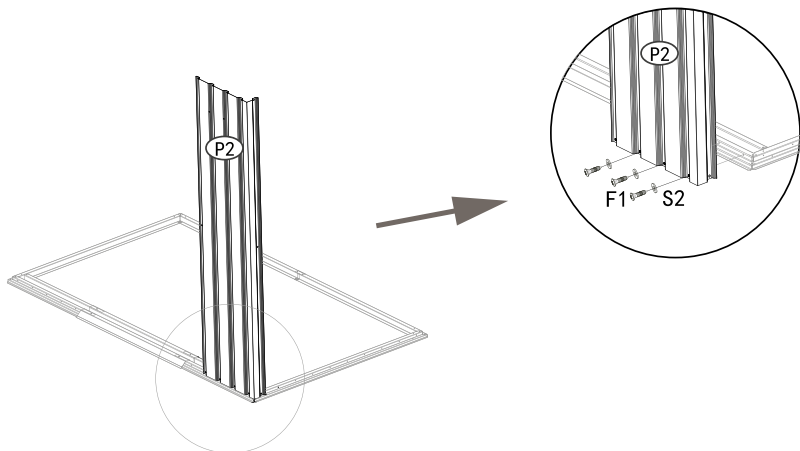

| PART | NO. | Qty. |
|---|-----|------|
|  | 5 | 1 |
|  | F1 | 4 |



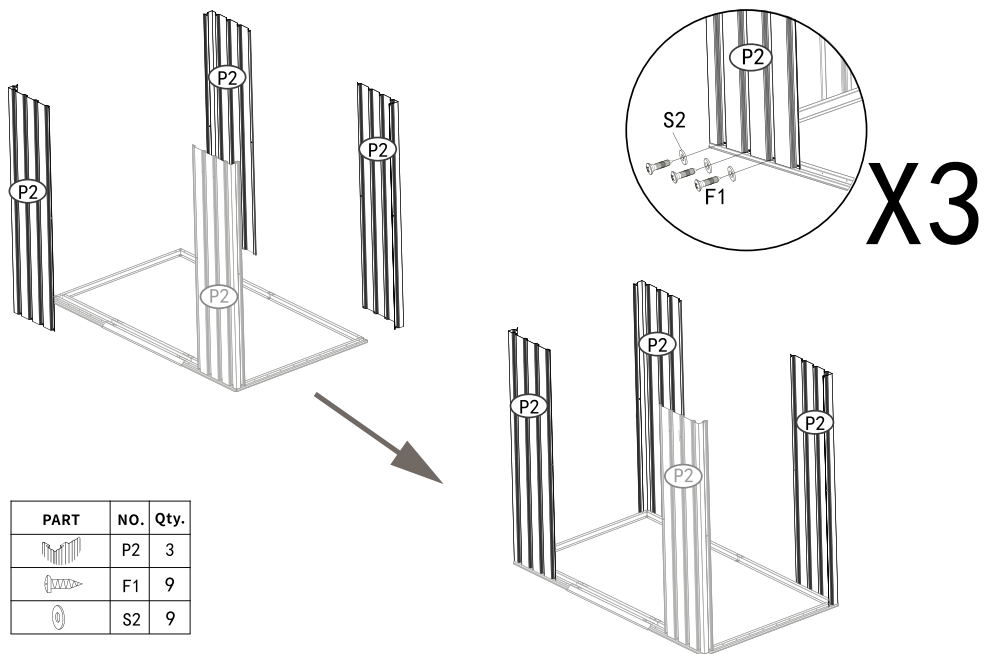



| PART | NO. | Qty. |
|---|-----|------|
|  | P2 | 1 |
|  | F1 | 3 |
|  | S2 | 3 |

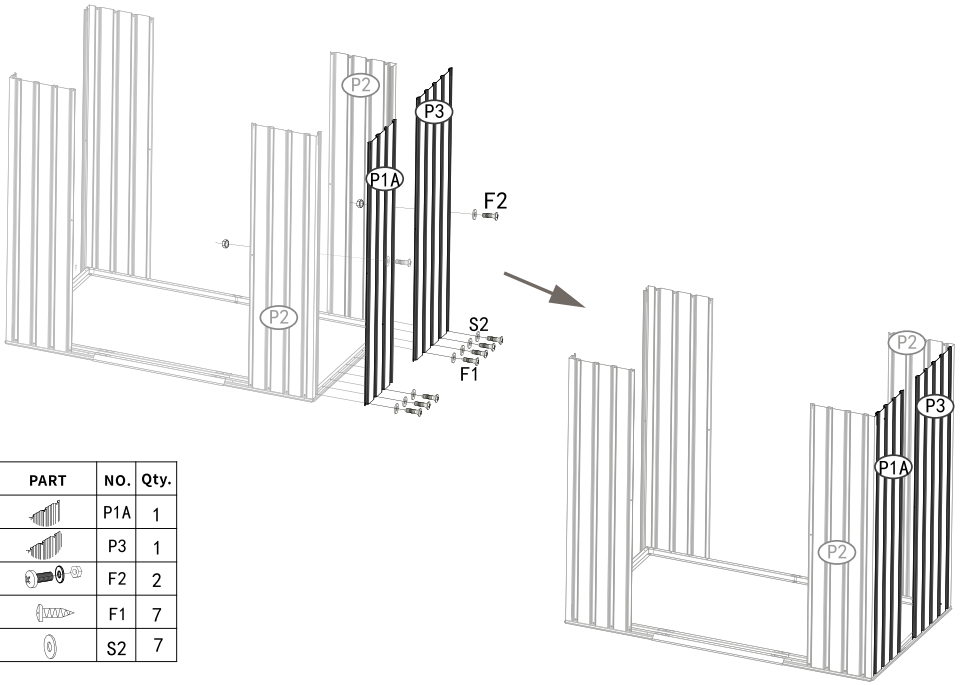







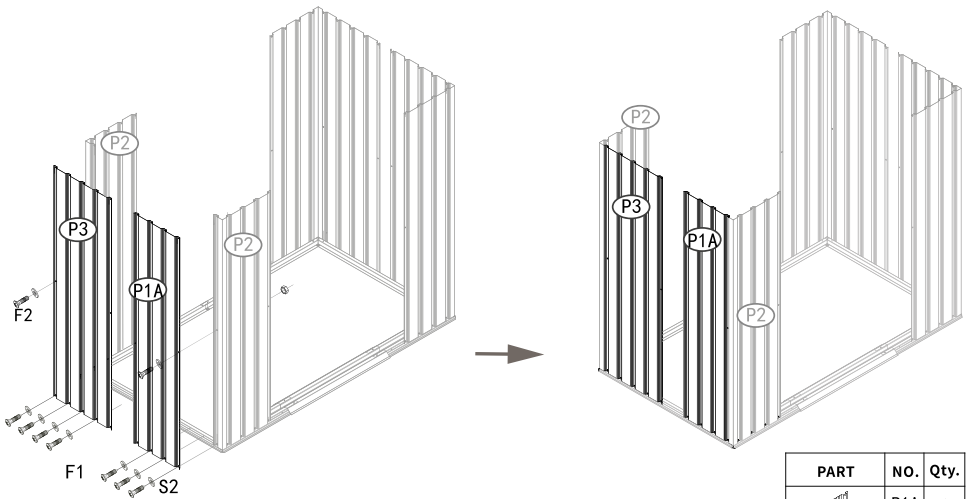

| PART | NO. | Qty. |
|---|-----|------|
|  | P2 | 3 |
|  | F1 | 9 |
|  | S2 | 9 |







| PART | NO. | Qty. |
|---|-----|------|
|  | P1A | 1 |
|  | P3 | 1 |
|  | F2 | 2 |
|  | F1 | 7 |
|  | S2 | 7 |



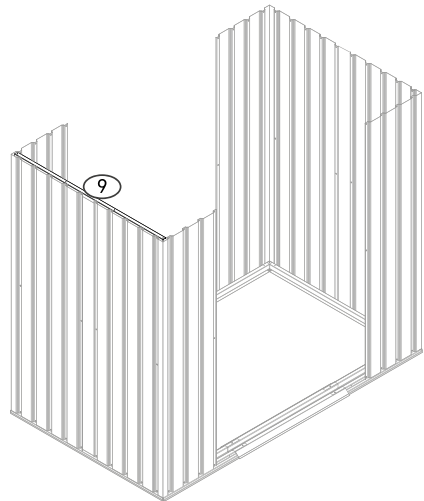
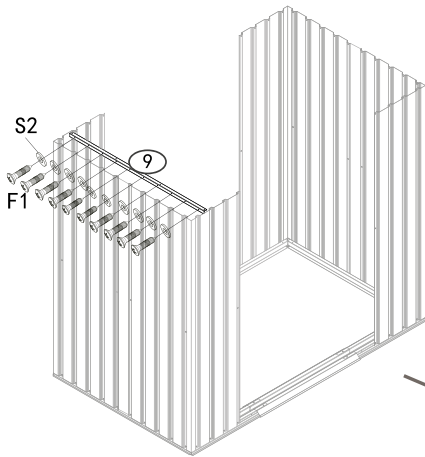
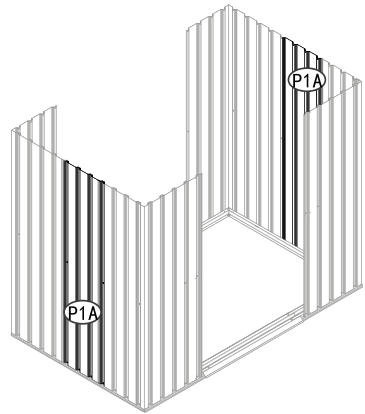
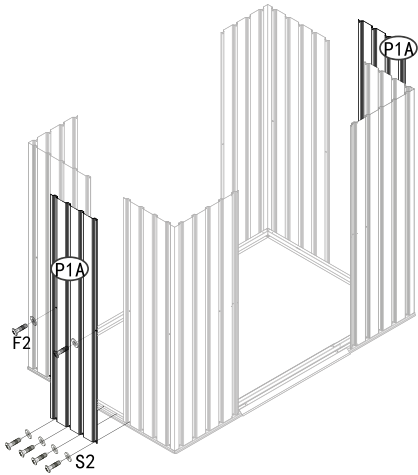



| PART | NO. | Qty. |
|---|-----|------|
|  | P1A | 1 |
|  | P3 | 1 |
|  | F2 | 2 |
|  | F1 | 7 |
|  | S2 | 7 |

| PART | NO. | Qty. |
|---|-----|------|
|  | P1A | 2 |
|  | F2 | 4 |
|  | F1 | 8 |
|  | S2 | 8 |

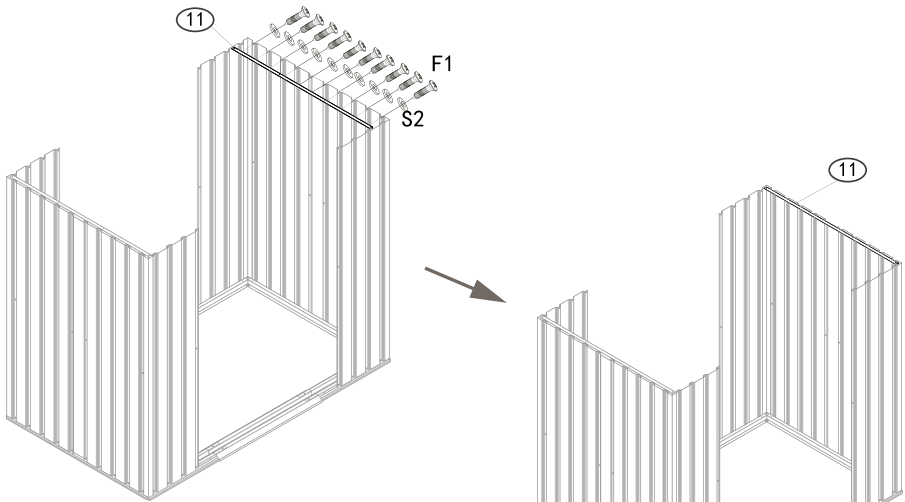



| PART | NO. | Qty. |
|---|-----|------|
|  | 9 | 1 |
|  | F1 | 11 |
|  | S2 | 11 |



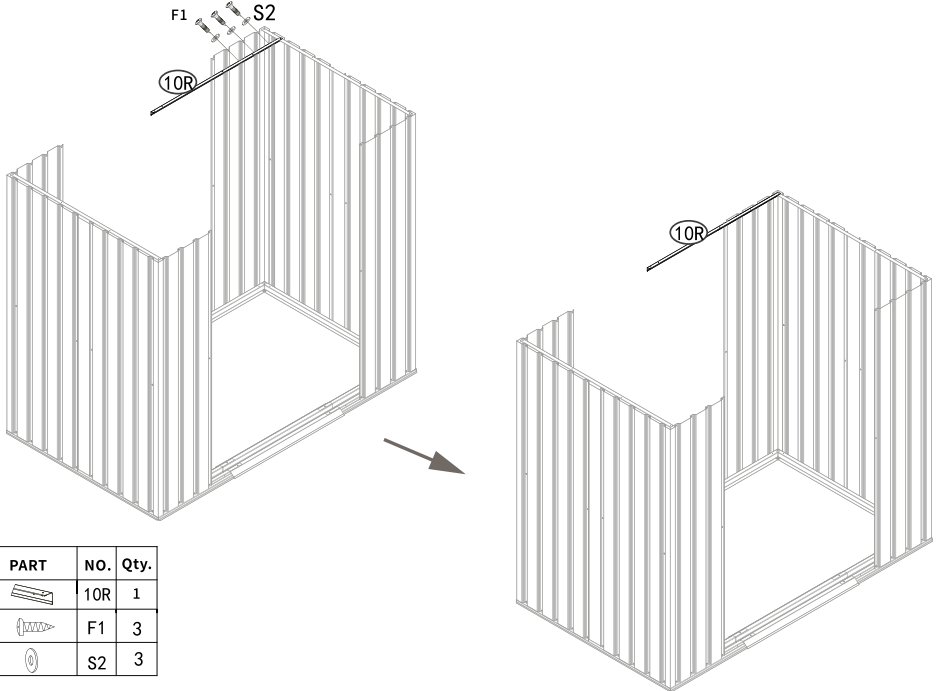

| PART | NO. | Qty. |
|---|-----|------|
|  | 11 | 1 |
|  | F1 | 11 |
|  | S2 | 11 |



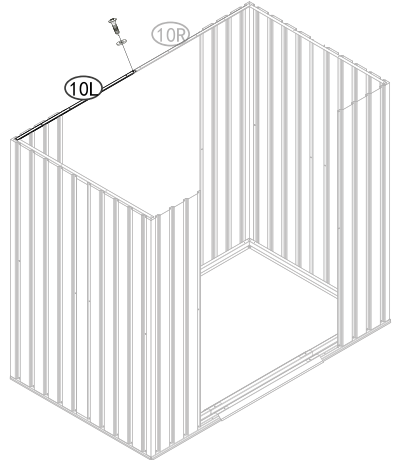
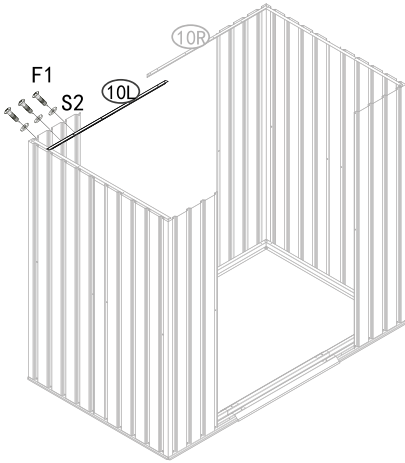



| PART | NO. | Qty. |
|---|-----|------|
|  | 10R | 1 |
|  | F1 | 3 |
|  | S2 | 3 |

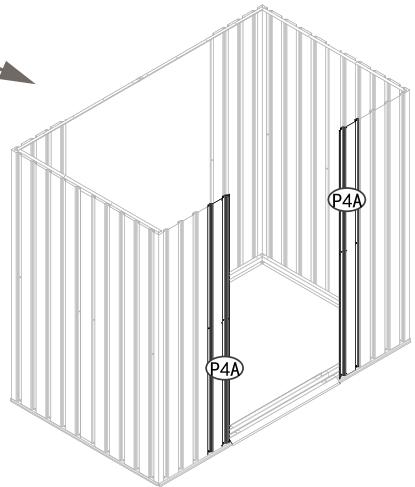
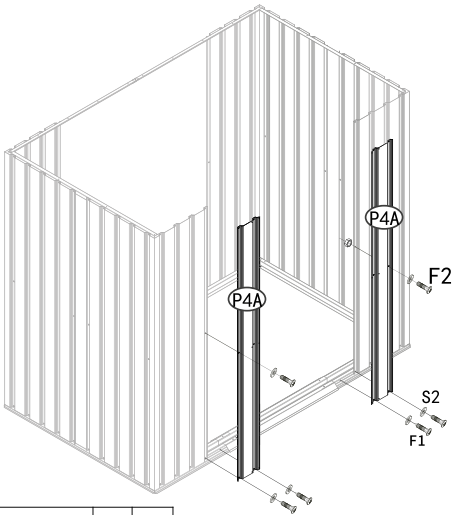

| PART | NO. | Qty. |
|---|-----|------|
|  | 10L | 1 |
|  | F1 | 4 |
|  | S2 | 4 |



| PART | NO. | Qty. |
|---|-----|------|
|  | P4A | 2 |
|  | F2 | 2 |
|  | F1 | 4 |
|  | S2 | 4 |

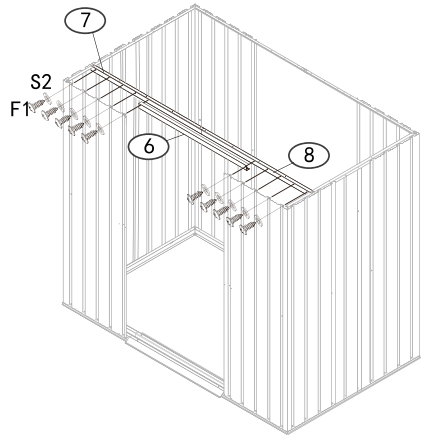
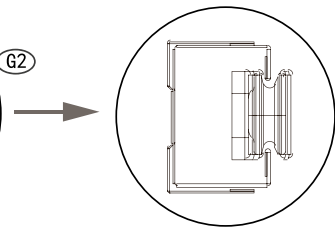
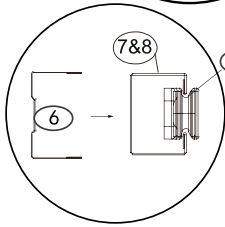
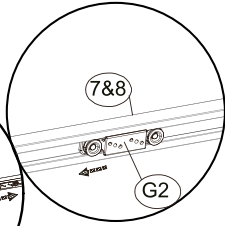
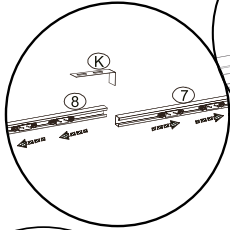
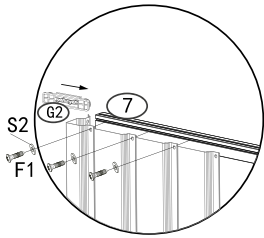



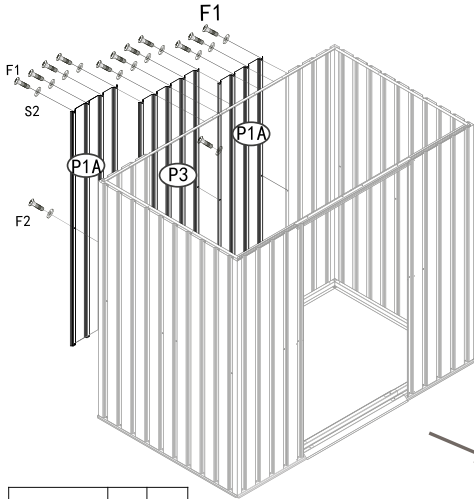

| PART | NO. | Qty. | PART | NO. | Qty. |
|------|-----|------|------|-----|------|
| | 6 | 1 | | K | 1 |
| | 7 | 1 | | F1 | 10 |
| | 8 | 1 | | S2 | 10 |
| | G2 | 4 | | | |

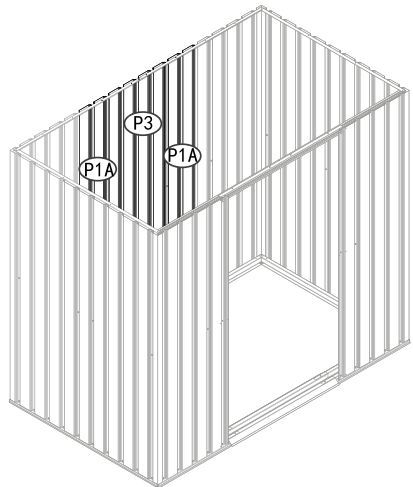

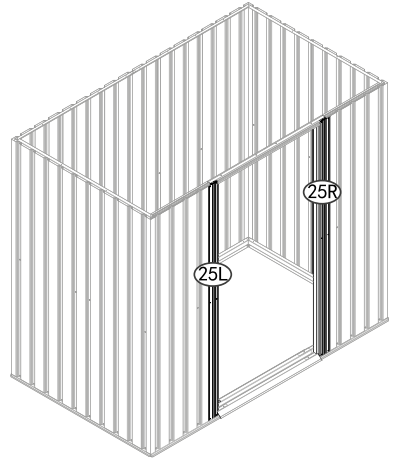
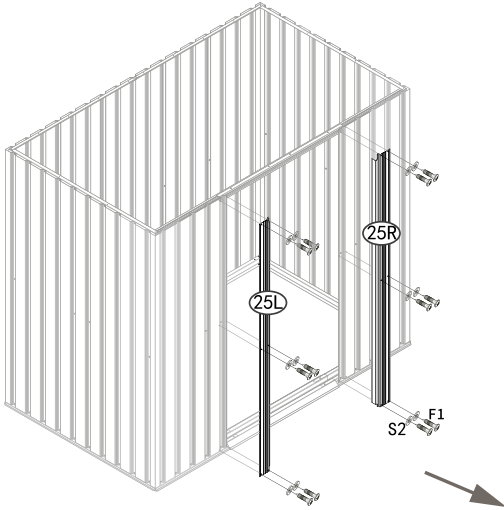





| PART | NO. | Qty. |
|------|-----|------|
| | P1A | 2 |
| | P3 | 1 |
| | F2 | 4 |
| | F1 | 22 |
| | S2 | 22 |





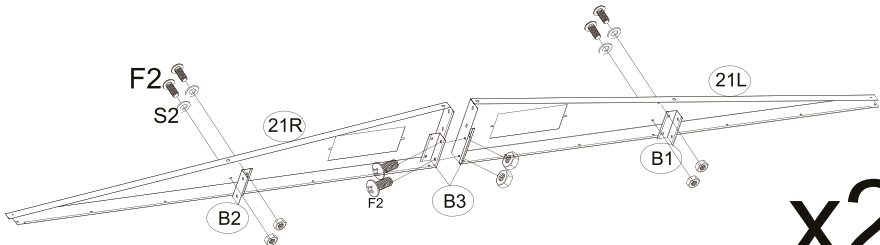

| PART | NO. | Qty. |
|---|-----|------|
|  | 25L | 1 |
|  | 25R | 1 |
|  | F1 | 12 |
|  | S2 | 12 |

| PART | NO. | Qty. |
|---|-----|------|
|  | 21L | 1 |
|  | 21R | 1 |
|  | B1 | 2 |
|  | B2 | 2 |
|  | B3 | 4 |
|  | F2 | 12 |
|  | S2 | 12 |



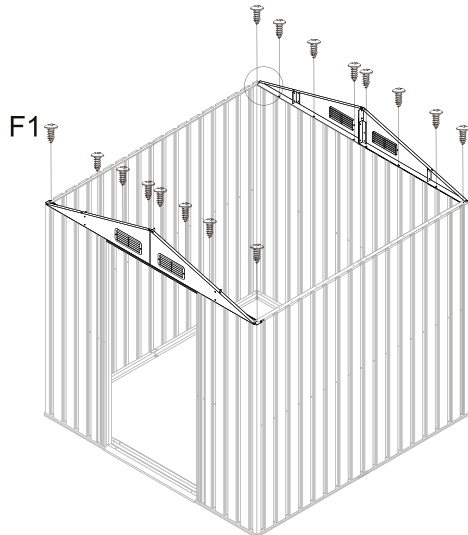
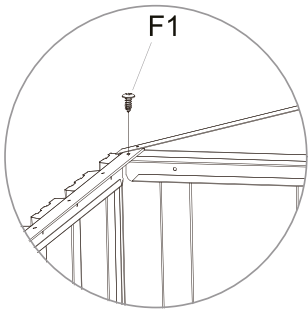
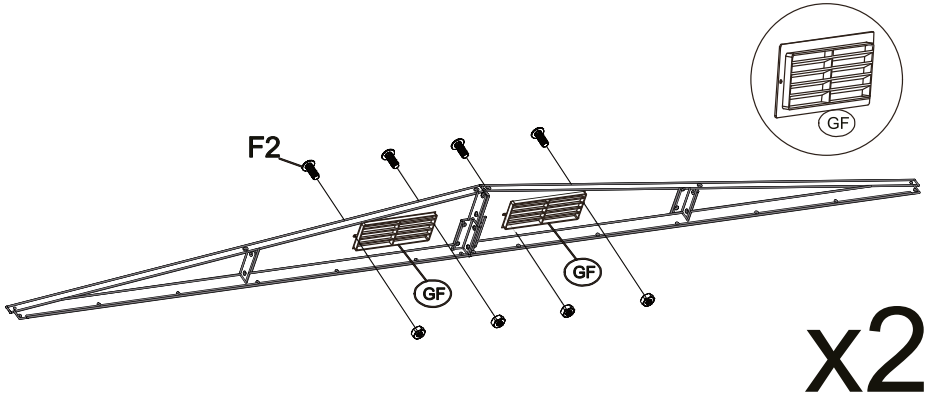

x2

| PART | NO. | Qty. |
|---|-----|------|
|  | GF | 4 |
|  | F2 | 8 |



| PART | NO. | Qty. |
|---|-----|------|
|  | F1 | 16 |

| PART | NO. | Qty. |
|---|-----|------|
|  | 13 | 1 |
|  | 14 | 1 |
|  | F2 | 2 |

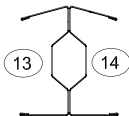
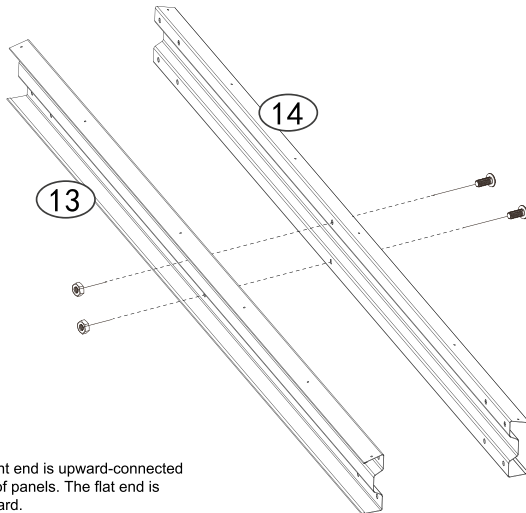

The bent end is upward-connected with roof panels. The flat end is downward.

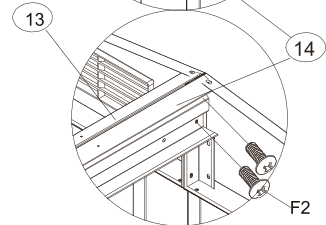
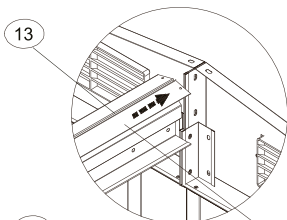



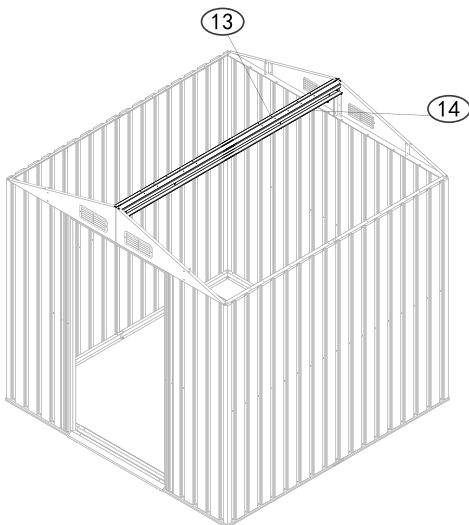

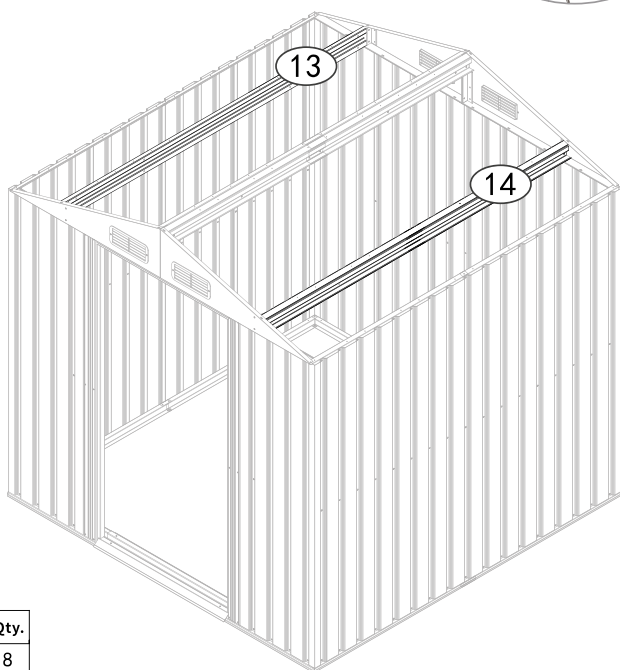
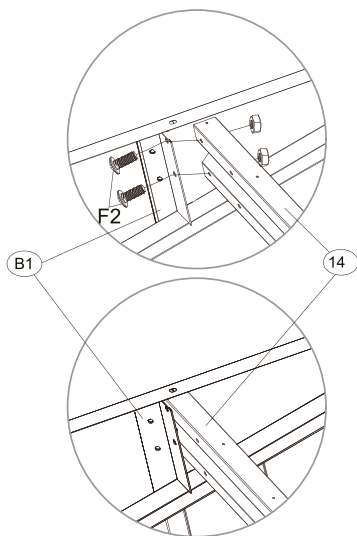
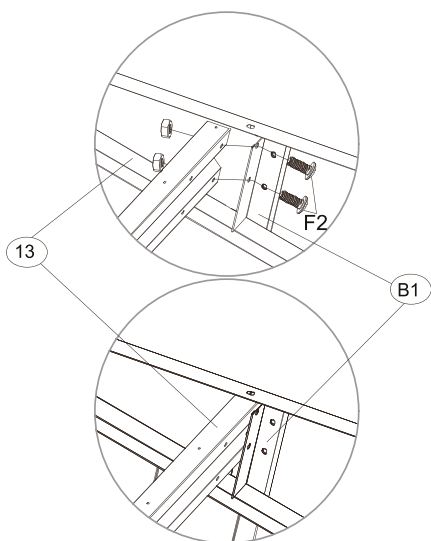

x2









| PART | NO. | Qty. |
|---|-----|------|
|  | F2 | 4 |

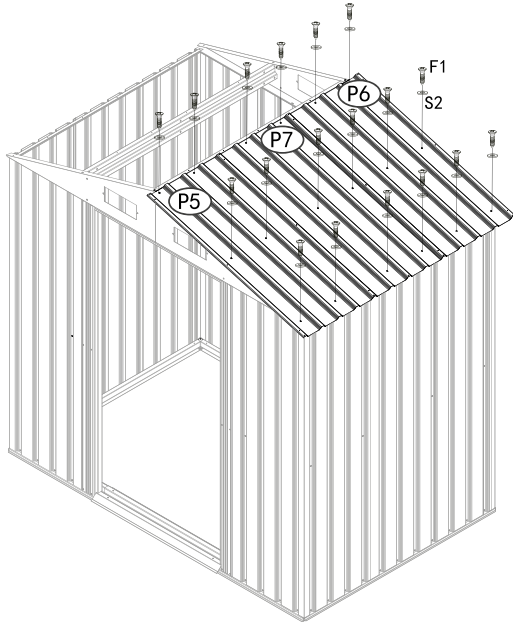





| PART | NO. | Qty. |
|---|-----|------|
|  | F2 | 8 |

| PART | NO. | Qty. |
|---|-----|------|
|  | P5 | 1 |
|  | P6 | 1 |
|  | P7 | 1 |
|  | F1 | 18 |
|  | S2 | 18 |

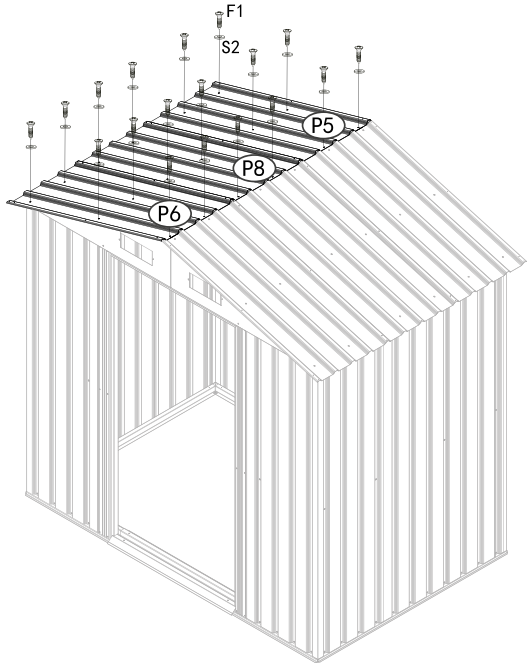



| PART | NO. | Qty. |
|---|-----|------|
|  | P5 | 1 |
|  | P6 | 1 |
|  | P8 | 1 |
|  | F1 | 18 |
|  | S2 | 18 |



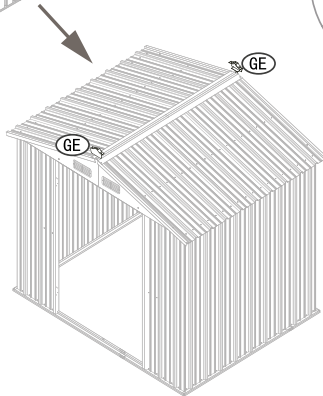
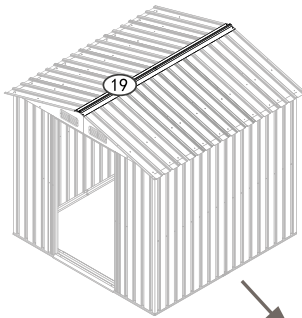
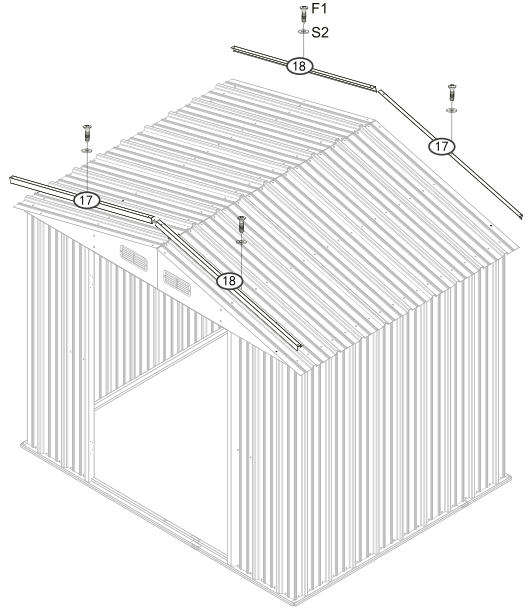

| PART | NO. | Qty. |
|---|-----|------|
|  | 17 | 2 |
|  | 18 | 2 |
|  | F1 | 4 |
|  | S2 | 4 |

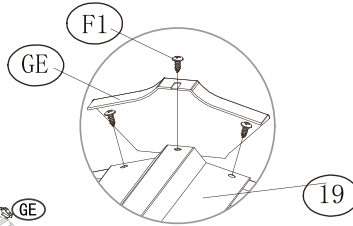

| PART | NO. | Qty. |
|---|-----|------|
|  | 19 | 1 |
|  | GE | 2 |
|  | F1 | 6 |



x2

| PART | NO. | Qty. |
|---|-----|------|
|  | 15 | 2 |
|  | GC | 2 |
|  | F1 | 4 |

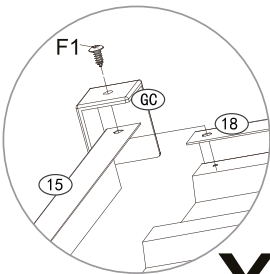
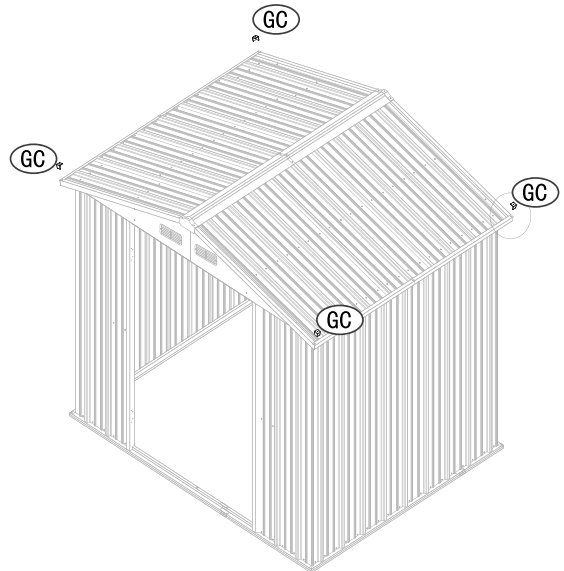
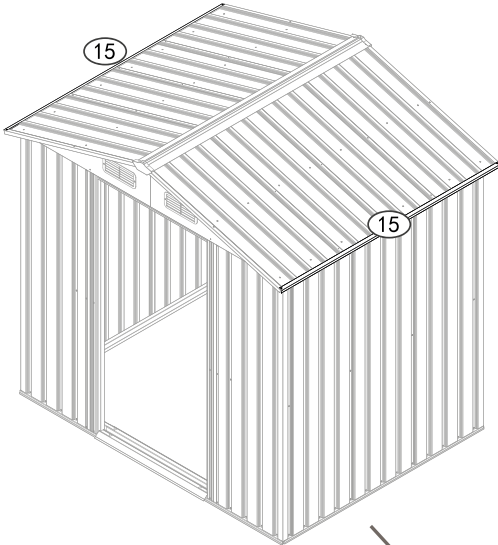

x4

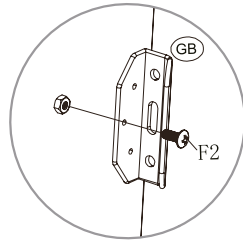
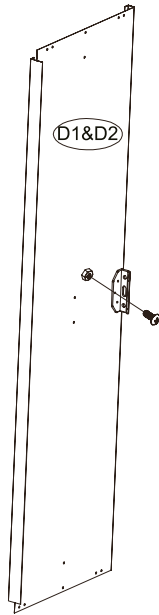

x2

| PART | NO. | Qty. |
|------|-----|------|
| | D1 | 1 |
| | D2 | 1 |
| | GB | 2 |
| | F2 | 2 |

D1&D2

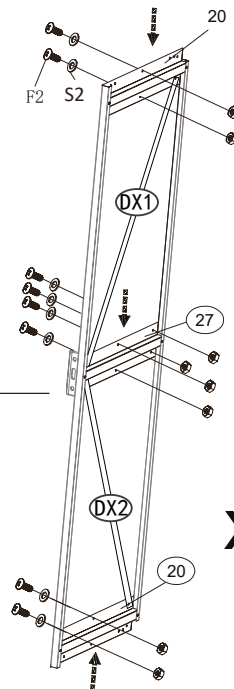

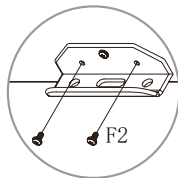

x2



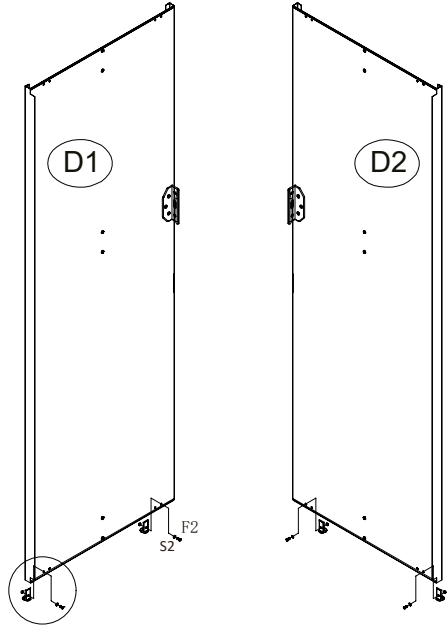
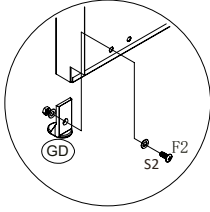

| PART | NO. | Qty. |
|------|-----|------|
| | 20 | 4 |
| | 27 | 2 |
| | DX1 | 2 |
| | DX2 | 2 |
| | F2 | 20 |

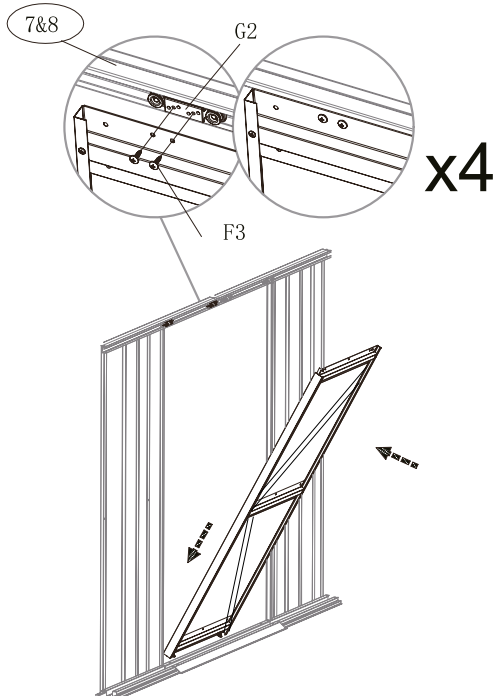

| PART | NO. | Qty. |
|---|-----|------|
|  | GD | 4 |
|  | F2 | 4 |



| PART | NO. | Qty. |
|---|-----|------|
|  | F3 | 8 |

| PART | NO. | Qty. |
|---|-----|------|
|  | S1 | 142 |

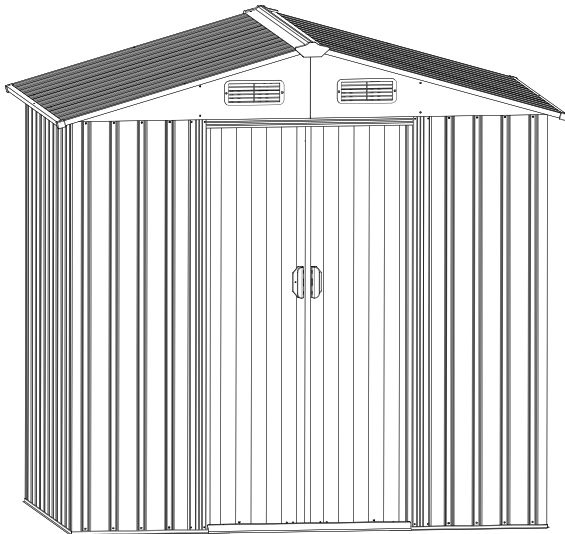
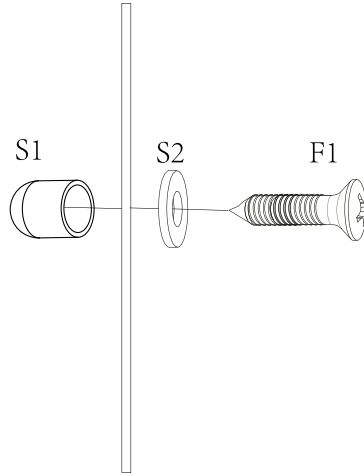



Thank
you and
congratulations!



OKORU GLOBAL S.L. // Pol. Ind. Barros nº 29. 39408 Barros. Cantabria - España
(+34) 942 842 170 · info@okorules // MADE IN P.R.C.