

# INSTRUCCIONES DE MONTAJE

## ME10S02



20

COMPLEMENTOS DECORATIVOS  
DEL BAÑO, S.L.

Avda. Can Roqueta 70, 08202 Sabadell, Barcelona,  
España

DdP nº 4

UNE-EN 14428

Higiene Personal

Estabilidad: cumple  
Fuerza: cumple  
Estanqueidad: cumple

### Recomendaciones previas

- Verificar que la mampara no tiene ningún desperfecto y/o anomalía
- Verificar que la base donde se va a colocar está perfectamente alineada y seca
- IMPORTANTE:** En el caso de observar cualquier anomalía al respecto **NO INSTALAR** y comunicar a la tienda la situación.

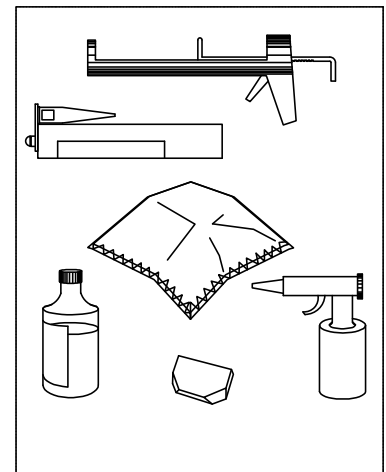
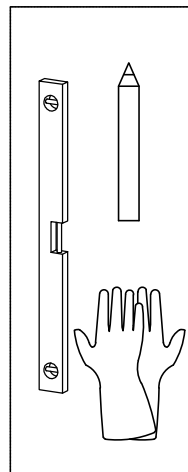
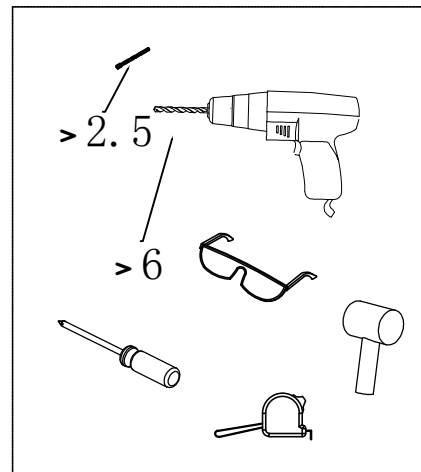
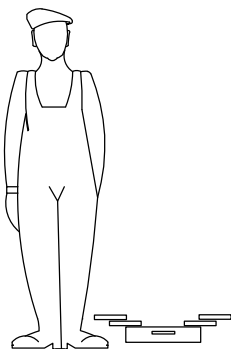
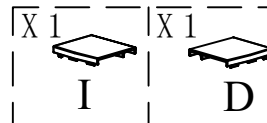
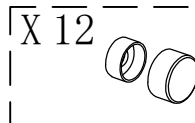
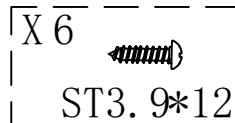
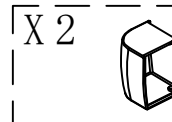
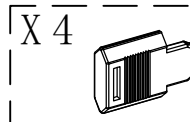
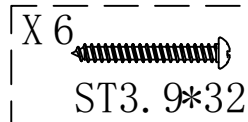
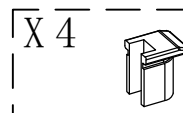
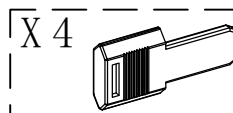
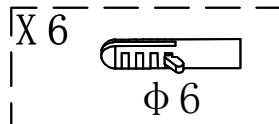
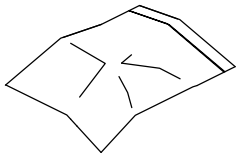
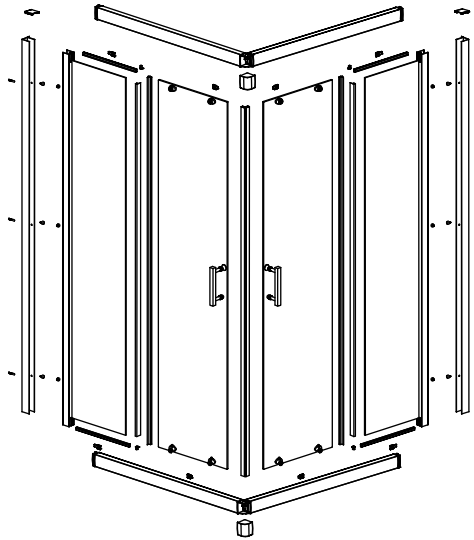
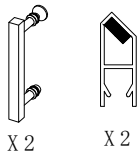
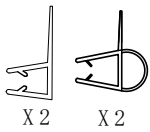
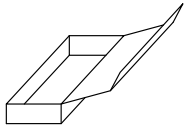

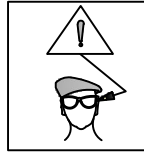
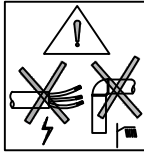
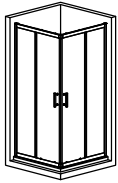

ME10S02

1

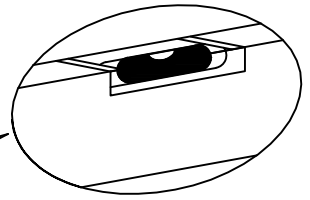
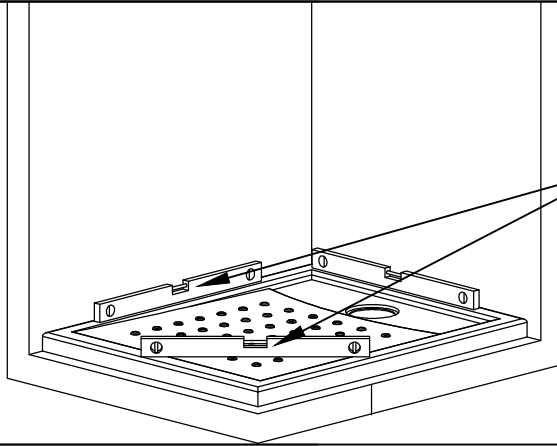
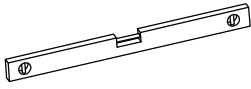

2

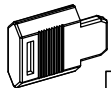

X4

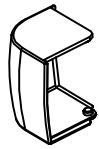

X2

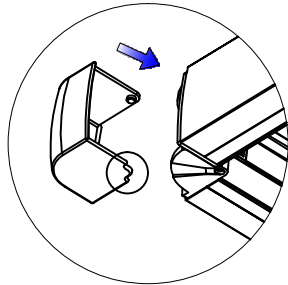

ARRIBA

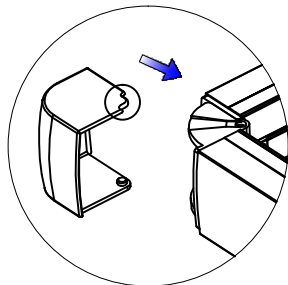
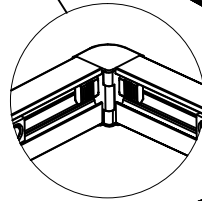
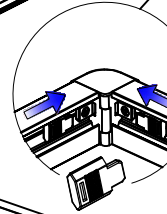
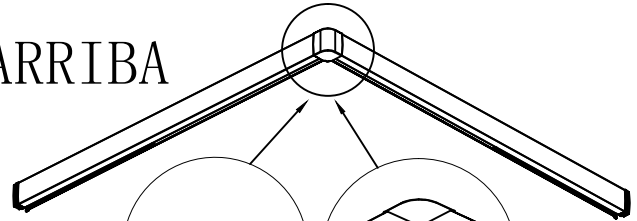

ABAJO

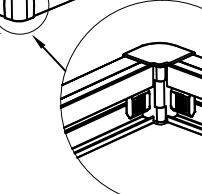
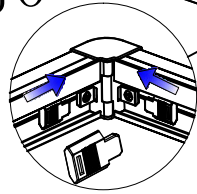
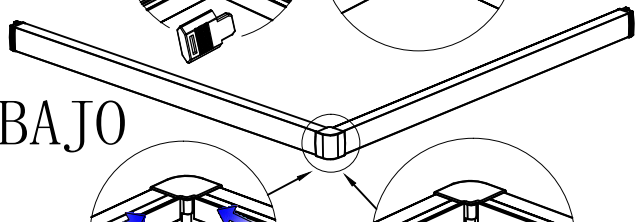

3

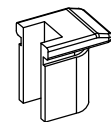
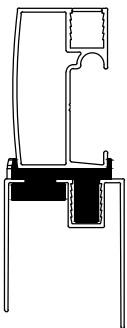

X2

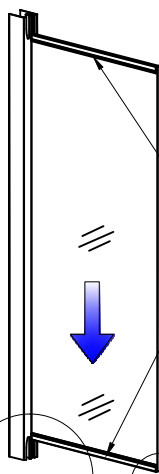
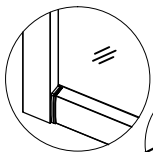
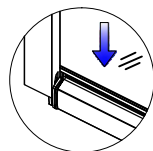
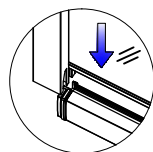

3.1

3.2

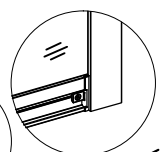
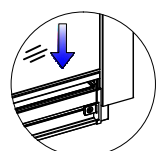
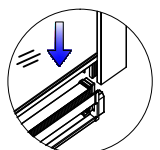
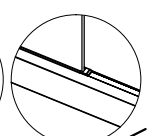
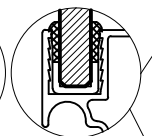
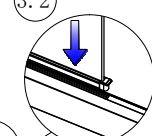
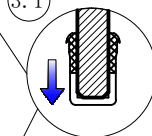

Outside

Inside

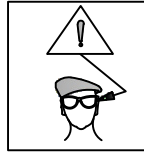
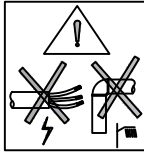
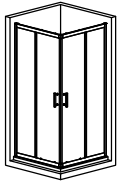

ME10S02

4

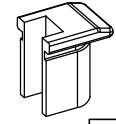

X2

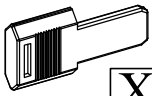

X4

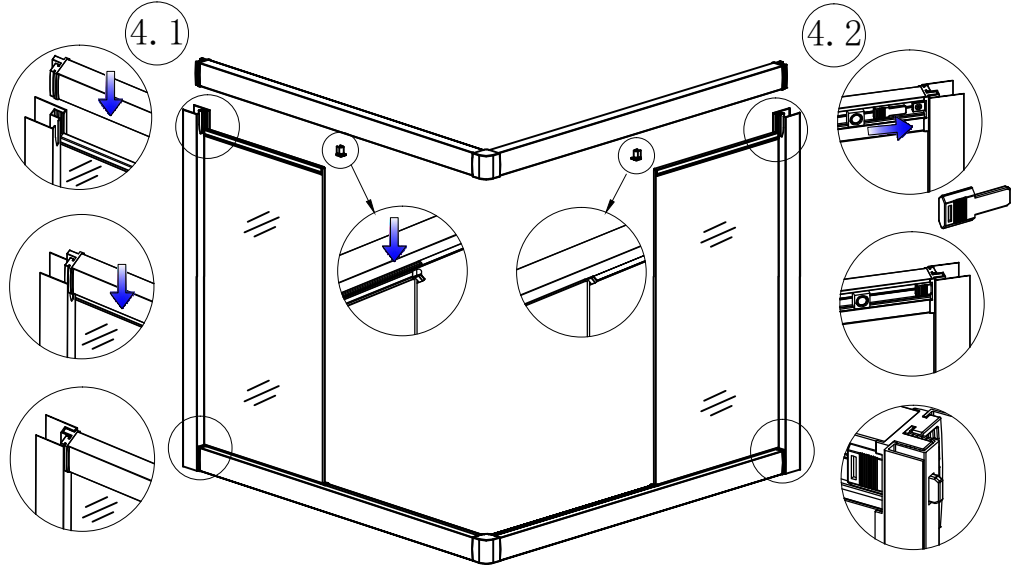

5

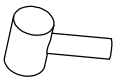
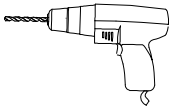
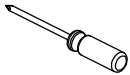
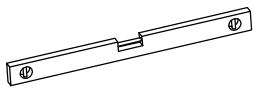

ST3, 9\*32 X6



X6

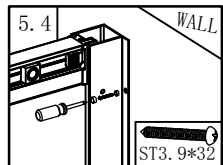
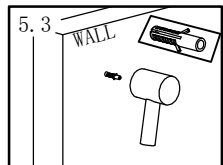
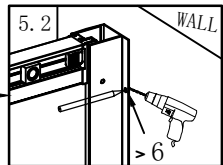
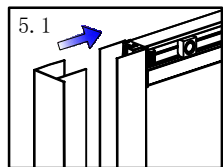
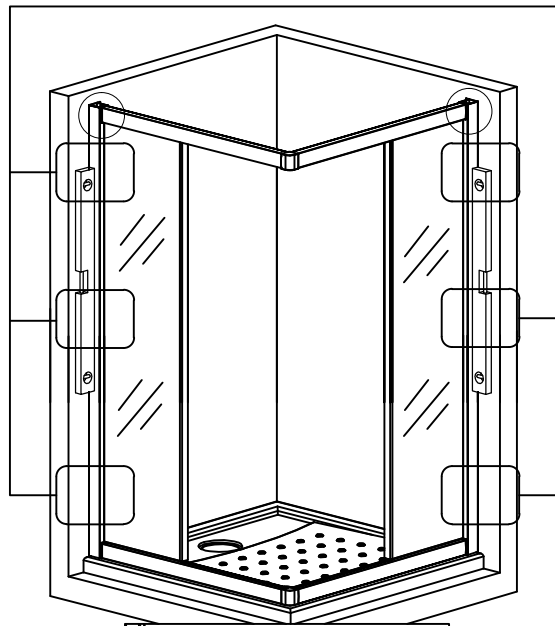

6

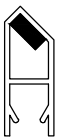

X2

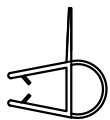

X2

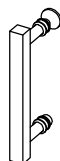

X2

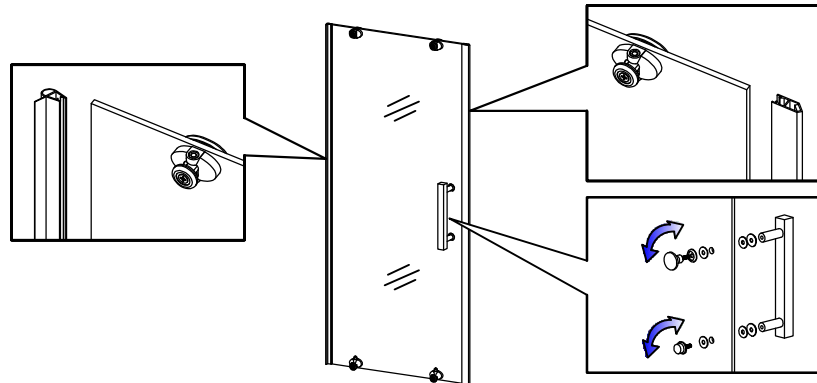

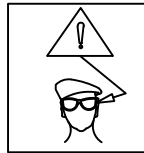
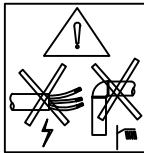
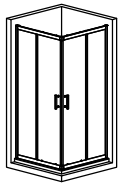

ME10S02



X 2

7

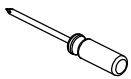
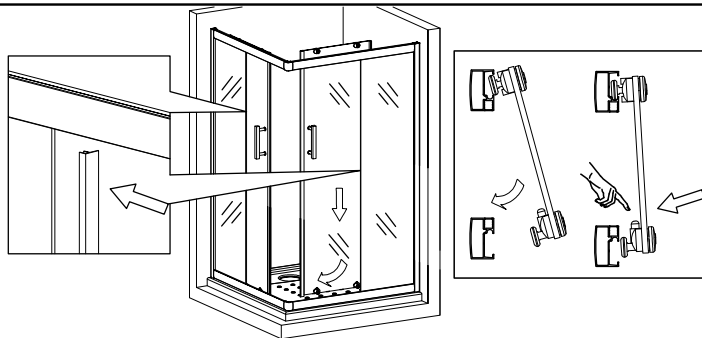

8

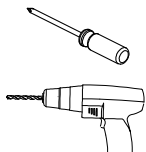
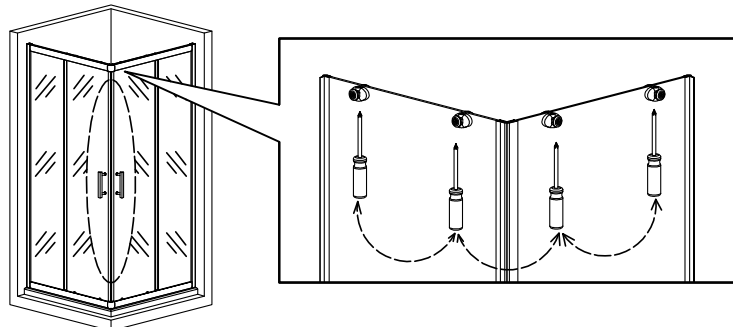

ST3. 9\*12



9

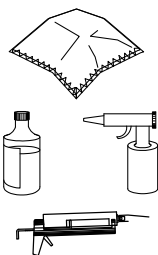
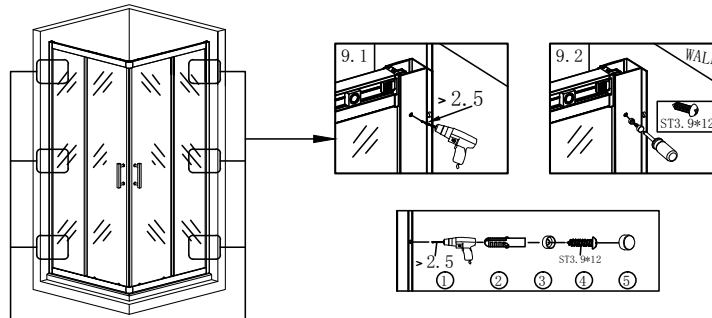

10

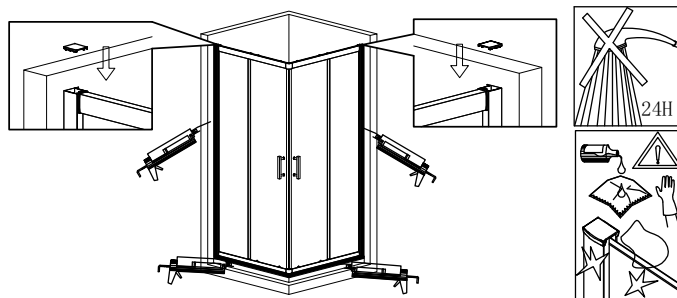

### Consejos de mantenimiento

- Tras cada uso, aclarar con agua y secar la mampara con un paño suave y seco.
- Para eliminar la cal y restos residuales, se puede utilizar una espátula limpia-mamparas para evitar rayaduras.
- Ventilar para evitar la formación de bacterias y moho.

### Consejos de limpieza

- Hacer una limpieza periódicamente en profundidad.
- En caso de utilizar un producto especial para el baño, asegúrese que se usa como indica el envase, la incorrecta utilización puede provocar deterioro de la mampara.
- Se ruega no utilizar los siguientes elementos para limpiar la mampara: ácidos, disolventes, acetona y productos abrasivos.