

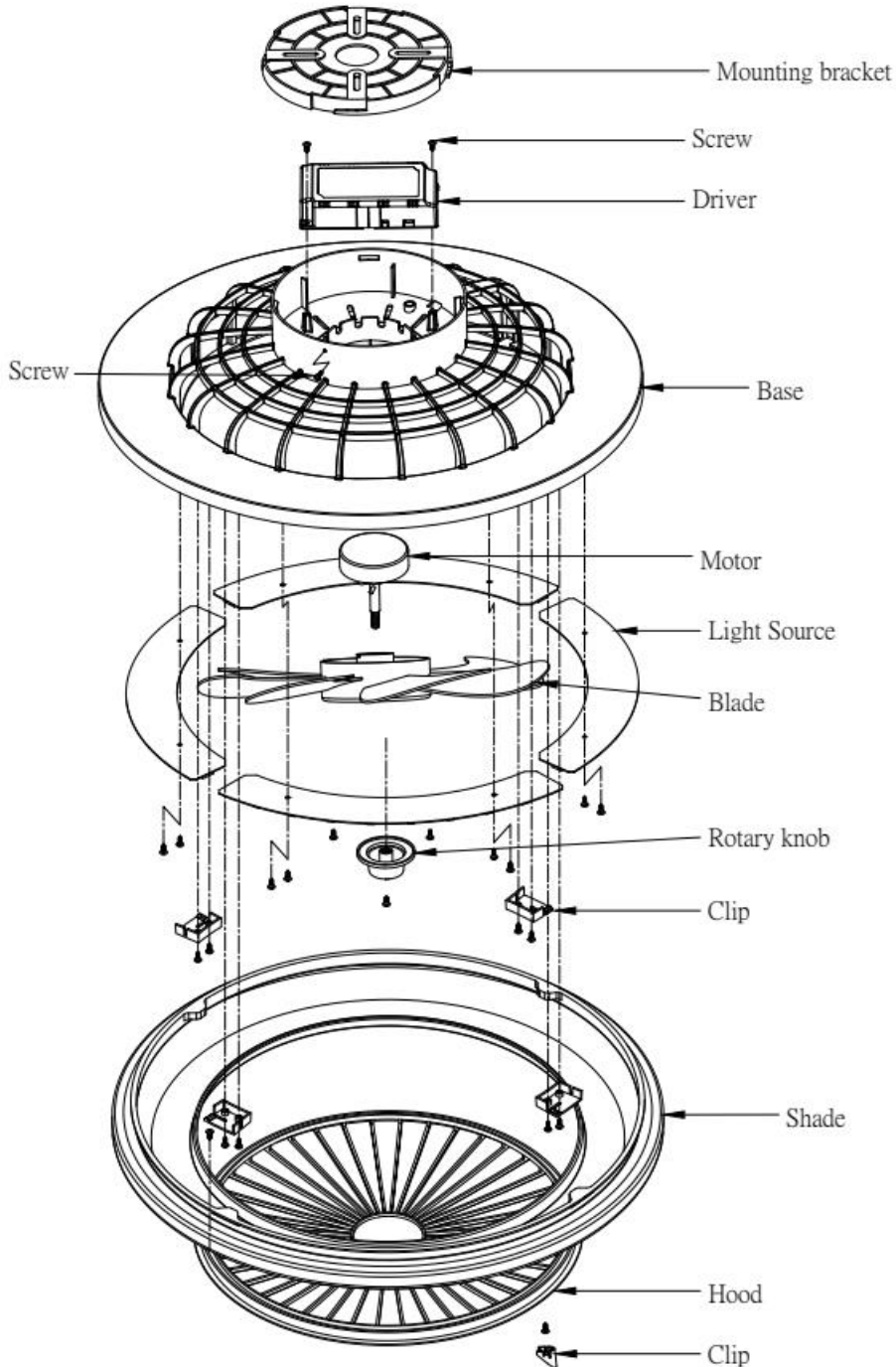











# Removability Introduction on Disposal at End of Life

## Composition Explanation – Flat Fan Ceiling



# Removability Introduction on Disposal at End of Life

## Composition Explanation – Flat Fan Ceiling

Plastic part	Electrical part	Metal part
Base 	Light Source 	Screw 
Shade 	Driver 	
Blade 	Motor 	
Hood 		
Rotary knob 		
Mounting bracket 		
Clip 		

### C Recommendation on disposal

- Plastic part :reuse and recycling
- Electrical part :incineration and disposal
- Metal part :recycling

# Removability Introduction on Disposal at End of Life

## Composition Explanation – Flat Fan Ceiling

