

**AUFBAUANLEITUNG** **DE**

**INSTRUCTIONS DE MONTAGE** **FR**

**BOUWINSTRUCTIES** **NL**

**SZERELÉSI ÚTMUTATÓ** **HU**

**INSTRUCȚIUNI DE ASAMBLARE** **RO**

**NAVODILA ZA SESTAVLJANJE** **SL**

**NÁVOD PRO MONTÁŽ** **CZ**

**NÁVOD NA MONTÁŽ** **SK**

**MONTERINGSANVISNING** **SE**

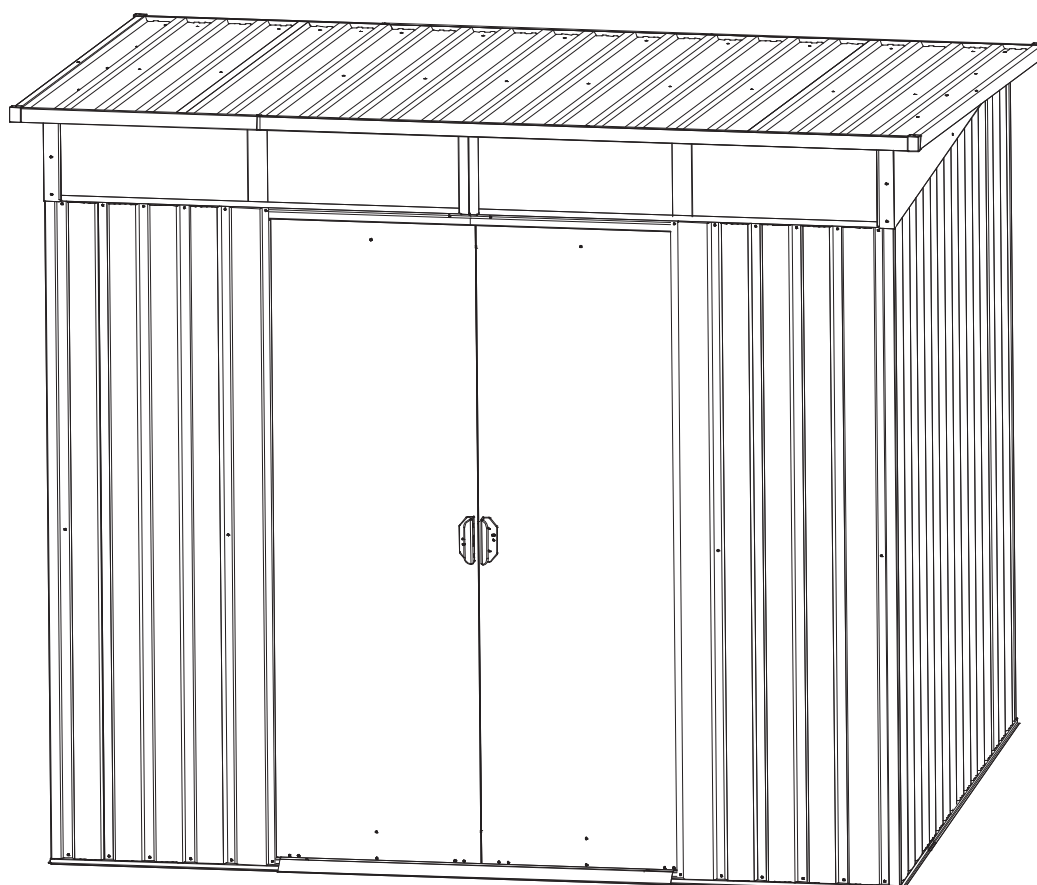



## GERÄTEHAUS LIGHTLINE MIT PULTDACH AUFBAUANLEITUNG

DE

Maße: L x B x H 239 x 193 x 202 cm

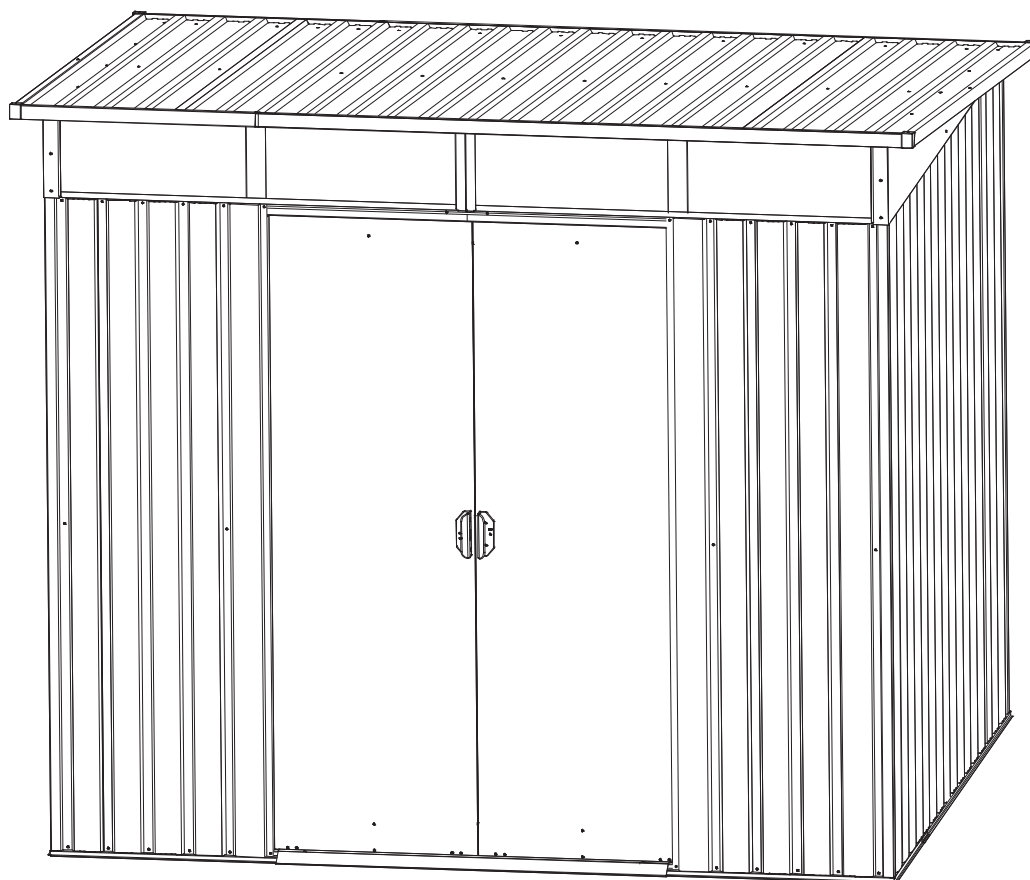

### HINWEIS

Lesen Sie die Aufbauanleitung sorgfältig, bevor Sie mit dem Aufbau des Gerätehauses beginnen. Dies gilt insbesondere für die Sicherheitshinweise.

Andernfalls können Sie sich verletzen oder das Gerätehaus beschädigen.

Das Gerätehaus ist kein Klettergerüst für Kinder und keine Rankhilfe. Es besteht die Gefahr der Überlastung. Stellen Sie sicher, dass alle benötigten Bauteile in der angegebenen Menge vorhanden sind.

Führen Sie die einzelnen Aufbauschritte nacheinander und in der angegebenen Reihenfolge, wie in dieser Anleitung vorgegeben, durch.

Überspringen Sie bitte keinen der angegebenen Schritte oder kürzen diese ab.

Verwahren Sie die Aufbauanleitung an einem sicheren Ort, um zu einem späteren Zeitpunkt erneut darauf zugreifen zu können.

## ALLGEMEINE INFORMATIONEN

Bevor Sie mit der Montage beginnen, stellen Sie sicher, dass die für Sie zutreffenden Richtlinien/Gesetze eingehalten werden. Planen Sie für die Montage mindestens 390 bis 450 Minuten Zeit ein.

Für die Montage werden mindestens 2 Personen benötigt. Prüfen Sie vor dem Beginn der Arbeit, dass alle Teile in der richtigen Menge vorhanden sind. Nutzen Sie zum Aufbau eine freie, sonnige Fläche ohne überstehende Äste. Prüfen Sie die einzelnen Bauteile vor Montagebeginn auf ihre Unversehrtheit und legen Sie diese so, dass die Bauteile während der Arbeit gut erreichbar sind.

Am besten bewahren Sie Kleinteile wie Schrauben, Mutter etc. in einer Schale auf, so dass diese nicht verloren gehen. Nutzen Sie das Gerätehaus auf keinen Fall als Rankhilfe für Hülsenfrüchte, Kletter- und Schlingpflanzen, Obst, Gemüse oder als Halterung für Ihre Wäscheleine.

Halten Sie das Gerätehaus frei von Schnee und Laub. **Die max. Traglast 90 kg/m<sup>2</sup>.**

Verwenden Sie das Gerätehaus ausschließlich wie in dieser Montageanleitung beschrieben.

Der Hersteller oder Händler übernimmt keine Haftung für Schäden, die durch nicht bestimmungsgemäßen oder falschen Gebrauch entstanden sind. Stellen Sie das Gerätehaus nicht direkt auf den Rasen oder unebene Untergründe, sorgen Sie für einen geeigneten, tragfähigen, waagerechten und stabilen Untergrund. Wir empfehlen das Gerätehaus fest auf dem Boden zu verankern. Stellen Sie sicher, dass alle Schrauben fest angezogen sind und dass der Rahmen richtig ausgerichtet und waagrecht ist. Prüfen Sie regelmäßig, dass alle Schrauben fest angezogen sind und ziehen Sie diese gegebenenfalls nach. **Einige Metallteile sind mit einer Schutzfolie versehen. Diese Folie muss vor Montagebeginn vorsichtig entfernt werden.**

## SICHERHEITSHINWEISE

Stellen Sie sich niemals direkt auf die Dachfläche, es besteht die Gefahr der Überlastung. Auch nicht während der Montage oder zur Reinigung.

Es besteht Gefahr für Kinder und Personen mit eingeschränkten physischen, sensorischen oder geistigen Fähigkeiten (z.B. übermüdete Personen, teilbehinderte Personen, ältere Personen mit reduzierten physischen und geistigen Fähigkeiten) oder Mangel an Erfahrung und Wissen (z.B. ältere Kinder).

Bei der Montage des Gerätehauses kommen Kleinteile wie Schrauben und Muttern zum Einsatz, von denen Erstickungsgefahr ausgeht, wenn sie verschluckt werden.

Das Gerätehaus darf nur von fachkundigen Personen aufgebaut werden, nicht von Kindern oder Personen mit eingeschränkten geistigen oder motorischen Fähigkeiten oder mangelnder Erfahrung.

Der nicht sachgemäße Umgang mit dem Gerätehaus kann zu Verletzungen oder Sachschäden führen.

Lassen Sie beim Auspacken der einzelnen Bauteile aus der Verpackung Vorsicht walten. **Es besteht Verletzungsgefahr an scharfen Kanten.** Einzelne Bauteile bestehen aus Metall und sind dadurch schwer. Bei einer unvorsichtigen Öffnung der Verpackung, zum Beispiel mit einem scharfen Messer oder einem anderen scharfen/spitzen Gegenstand besteht die Gefahr, dass Sie Bauteile beschädigen. Nach dem Auspacken der Bauteile prüfen Sie, ob alle Einzelteile in der richtigen Menge vorhanden sind. Legen Sie die einzelnen Teile auf eine Decke oder ähnliches, um Kratzer in der Beschichtung zu vermeiden.

Kontrollieren Sie, ob die einzelnen Bauteile in einem einwandfreien Zustand sind oder Beschädigungen aufweisen, in diesem Fall verwenden Sie die beschädigten, deformierten Teile nicht.

Tragen Sie während des Aufbaus und der Montage stets Sicherheitskleidung. Zur Grundausstattung gehören Sicherheitsschuhe, Schutzhandschuhe, Schutzbrille und Helm.

Installieren Sie das Gerätehaus nicht an sehr windigen oder regnerischen Tagen.

Stellen Sie sicher, dass die Bauteile keine Stromkabel berühren.

Entsorgen Sie die Verpackung, Kunststoffbeutel oder Schutzfolien sachgemäß und halten Sie diese außerhalb der Reichweite von Kindern, Erstickungsgefahr!

Stellen Sie das Gerätehaus auf eine ebene Fläche.

Stellen Sie sicher, dass während der Montage keine Kinder im Gefahrenbereich anwesend sind.

Platzieren Sie das Gerätehaus nicht in Bereichen, die starken oder andauernden Winden ausgesetzt sind.

Zu Ihrer persönlichen Sicherheit sollten Sie das Gerätehaus nicht aufbauen, wenn Sie müde, alkoholisiert oder berauscht sind, bzw. wenn Sie sich schwindlig fühlen oder Ihnen unwohl ist.

Wenn Sie Leitern oder elektronische Geräte verwenden, stellen Sie sicher, dass Sie sich an die jeweiligen Herstellerangaben zur Verwendung halten. Heiße Geräte wie Grills, Heizgeräte, Brenner etc. dürfen nicht in dem Gerätehaus verwendet oder gelagert werden, Brandgefahr! Stellen Sie sich bei Unwetter oder Gewitter nie in oder neben das Gerätehaus. Es besteht die Gefahr eines Blitzeinschlages.

## PFLEGE UND INSTANDHALTUNG

Reinigen Sie die Oberfläche regelmäßig. Sollten Sie Kratzer in der Oberfläche bemerken, beseitigen Sie diese umgehend mit einem geeigneten Lack. Verwenden Sie keine aggressiven Reinigungsmittel, Bürsten mit Metall- oder Nylonbürsten sowie keine scharfen oder metallischen Hilfsmittel wie Messer oder Spachtel.

Verwenden Sie zur Reinigung weiche Borsten. Verwenden Sie kaltes, sauberes Wasser.

## WERKZEUGE UND AUSRÜSTUNG

Sicherheitskleidung (Sicherheitsschuhe, Schutzhandschuhe, Schutzbrille, Helm etc.)

Wasserwaage

Längenmesser

Standleiter (ca. 1,5 m Höhe)

Schrauben- oder Ratschen-Schlüssel

Akkuschrauber und Bohrmaschine mit ver. Aufsätzen

Schraubendreher

(nicht im Lieferumfang enthalten)

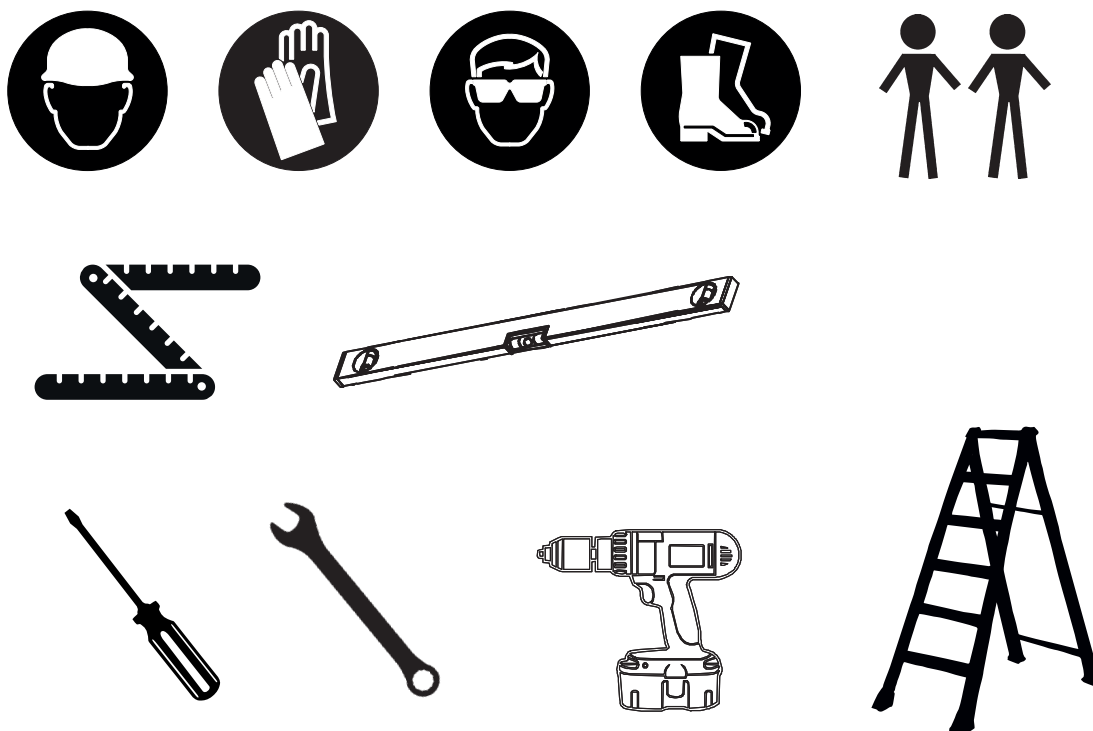

## VERPACKUNGSENTSORGUNG

Entsorgen Sie die Verpackung sortenrein.

Pappe und Karton wird als Altpapier entsorgt und Folien führen Sie der entsprechenden Wertstoffsammlung zu.

## ENTSORGUNG DES GERÄTEHAUSES





Achten Sie bei der Entsorgung des Gerätehauses auf die in Ihrem Land oder Bundesland geltenden Richtlinien, Gesetze und Bestimmungen bezüglich der Entsorgung.

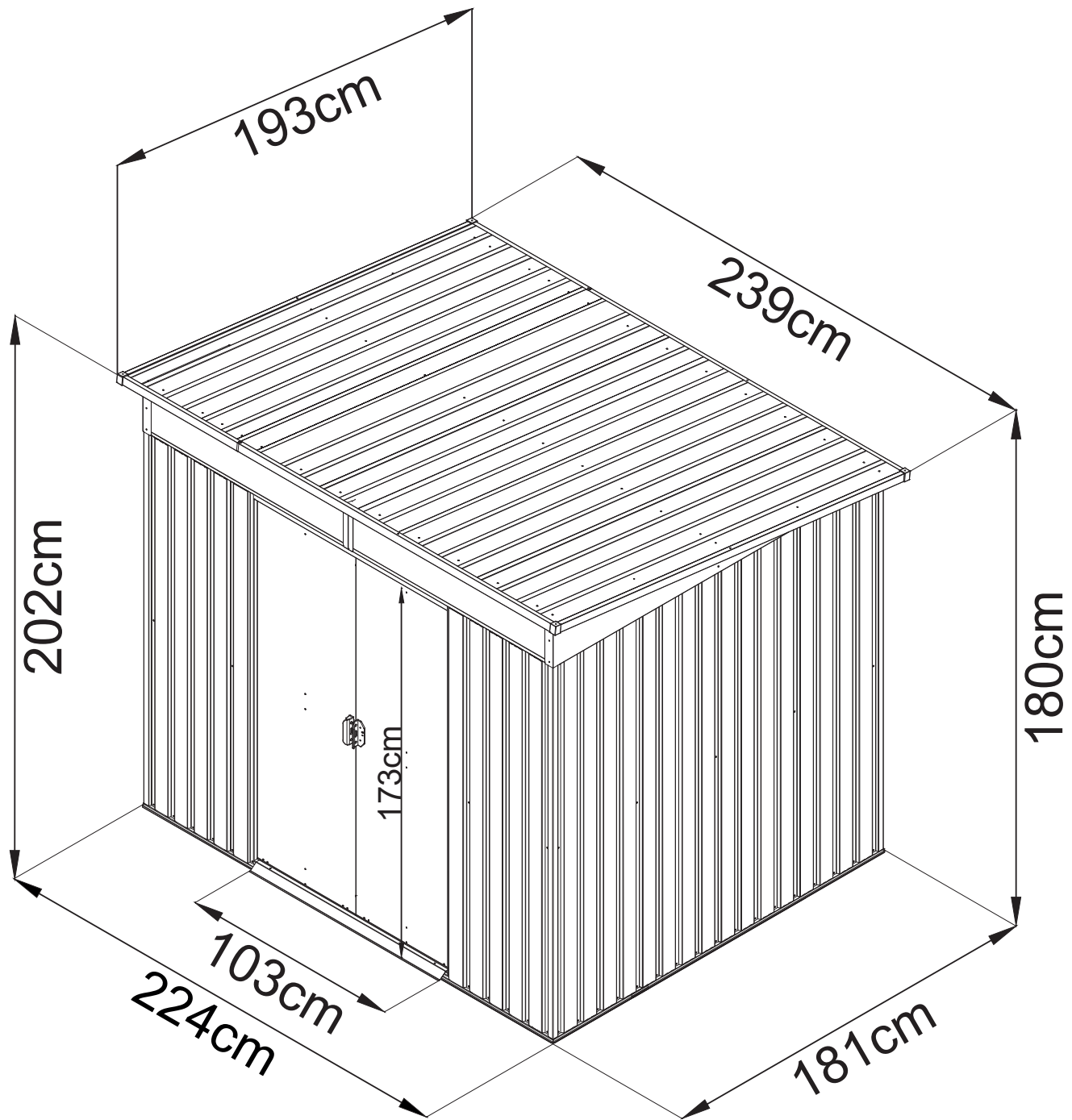



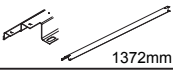
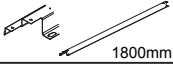
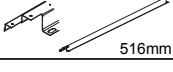
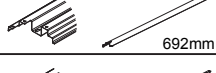
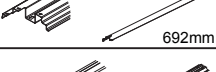
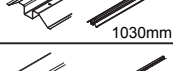
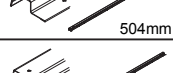
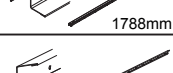
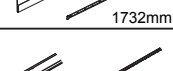
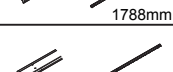
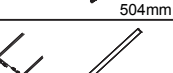
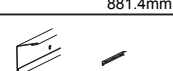

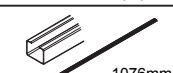
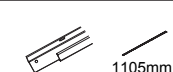
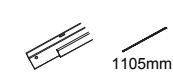
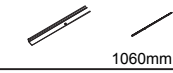
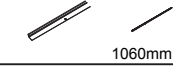
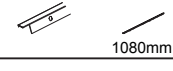
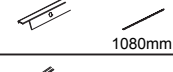
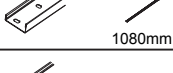

# ABMESSUNGEN

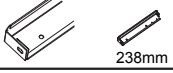
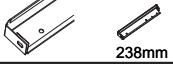
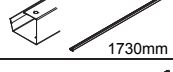
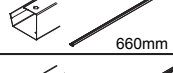
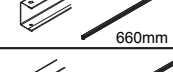
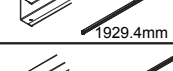
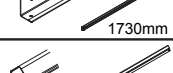
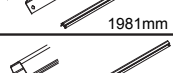
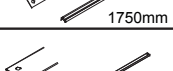
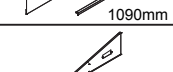
DE



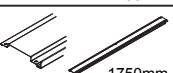
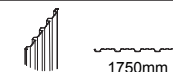

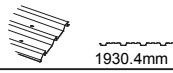
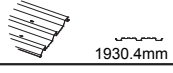
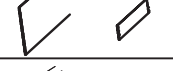
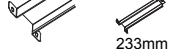







# TEILE-LISTE



NR.	TEIL	MENGE
1	 1372mm	2
2	 1800mm	1
1-1	 516mm	3
3L	 692mm	1
3R	 692mm	1
5	 1030mm	1
9-1	 504mm	1
9	 1788mm	1
20	 1732mm	2
11	 1788mm	1
11-1	 504mm	1
11-2	 881.4mm	1
B1	 128mm	2
7L	 1076mm	1
7R	 1076mm	1
12L	 1105mm	1
12R	 1105mm	1
14L	 1060mm	1
14R	 1060mm	1
15L	 1080mm	1
15R	 1080mm	1
16L	 1080mm	1
16R	 1080mm	1

NR.	TEIL	MENGE
19L	 238mm	1
19R	 238mm	1
10	 1730mm	1
10-1	 660mm	1
17-1	 660mm	1
17-2	 1929.4mm	2
17	 1730mm	1
13	 1981mm	2
13-1	 1750mm	2
6	 1090mm	1
21L		1
21R		1
18	 566mm	6
4L	 1750mm	1
4R	 1750mm	1
P1	 1750mm	15
P2	 1930.4mm	2
P3	 1930.4mm	3
P4	 1930.4mm	1
P5		2
22	 233mm	2

DE

# TEILE-LISTE

NR.	TEIL	MENGE
G2		4
GD		4
GB		2
GC		4
GS		2
F1		310
F2		58
F3		8
S2		167
S3		252

NR.	TEIL	MENGE
D1	 1740X570mm	1
D2	 1740X570mm	1

DE



# MONTAGE-ÜBERSICHT

DE

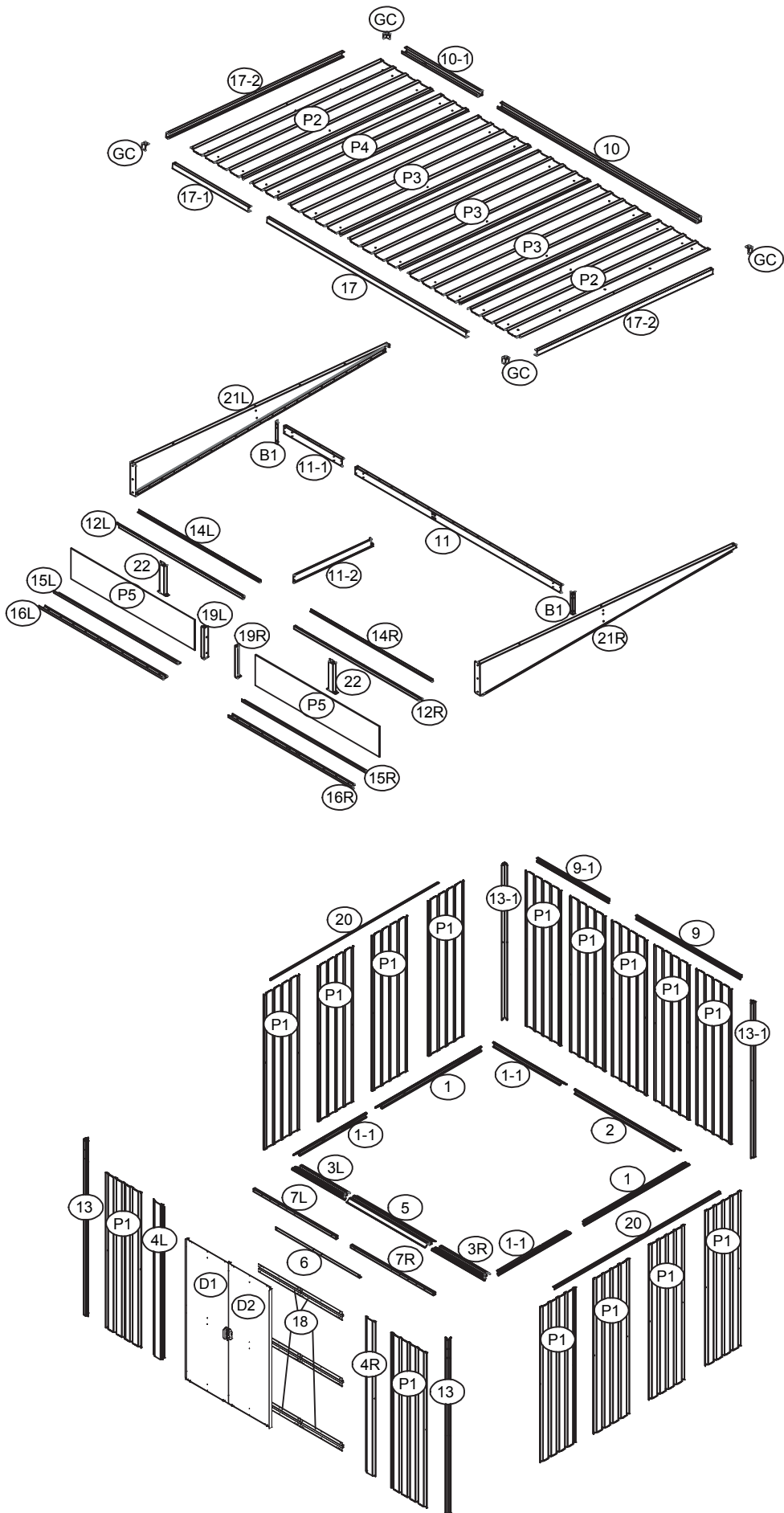

## ABRI DE JARDIN EN MÉTAL À TOIT 1 PAN LIGHTLINE INSTRUCTIONS DE MONTAGE

FR

Dimensions L x l x h 239 x 193 x 202 cm

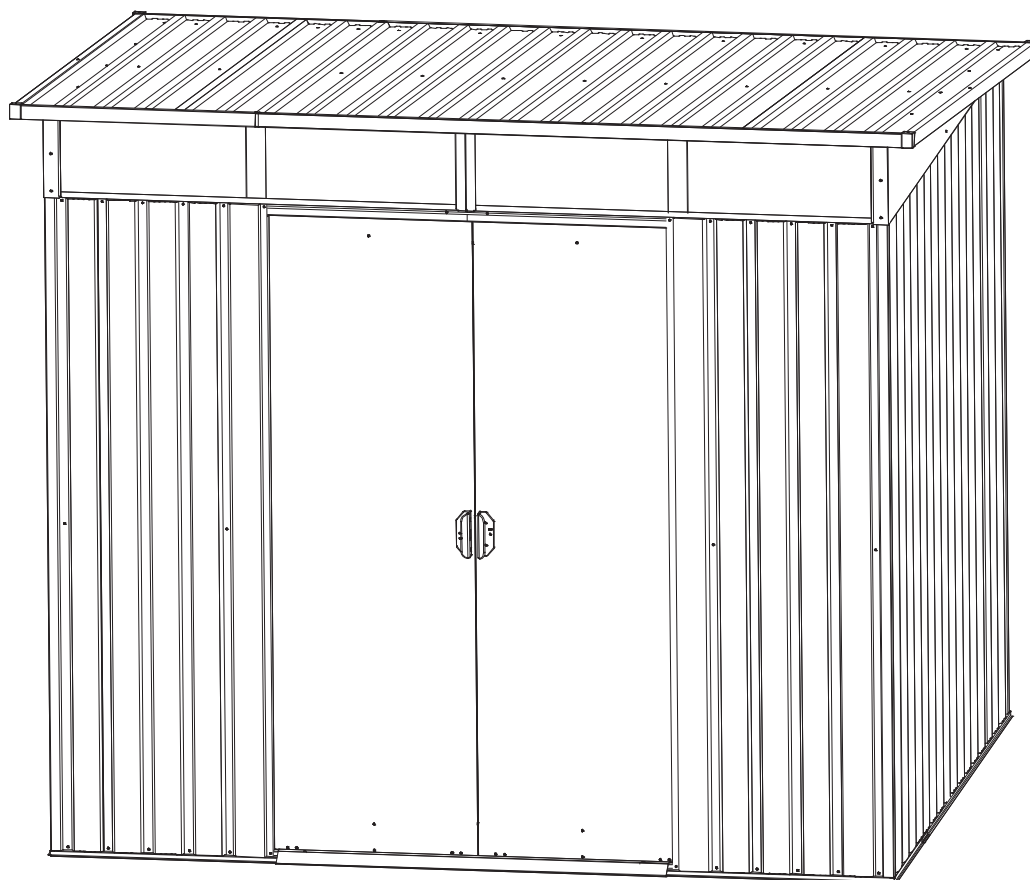

### NOTE

Lisez attentivement les instructions de montage avant de commencer à assembler l'abri de jardin. Cela vaut en particulier pour les consignes de sécurité.

Sinon, vous pourriez être blessé ou endommager l'abri.

L'abri de jardin n'est pas un support d'escalade pour les enfants ni un tuteur pour les plantes grimpantes. Il existe un risque de surcharge.

Assurez-vous que tous les éléments nécessaires à la construction sont disponibles dans les quantités spécifiées. Effectuez les différentes étapes de montage l'une après l'autre et dans l'ordre indiqué, comme décrit dans la présente notice.

Veuillez ne pas sauter ou abrégé l'une des étapes indiquées.

Conservez la notice de montage dans un endroit sûr afin de pouvoir vous y référer ultérieurement.

## INFORMATIONS GÉNÉRALES

Avant de commencer le montage, assurez-vous que les directives/lois qui vous sont applicables sont respectées.

Prévoyez au moins 390 à 450 minutes pour le montage.

Au moins 2 personnes sont nécessaires pour le montage.

Avant de commencer le travail, vérifiez que toutes les pièces sont disponibles dans les quantités requises.

Utilisez un espace libre et ensoleillé dépourvu de branches saillantes pour le montage.

Vérifiez l'intégrité des différents composants avant de commencer l'assemblage et placez-les de manière à ce qu'ils soient facilement accessibles pendant le travail.

Il est préférable de conserver les petites pièces telles que les vis, les écrous, etc. dans un bol afin de ne pas les perdre.

N'utilisez en aucun cas l'abri de jardin comme tuteur pour les légumineuses, les plantes grimpantes et rampantes, les fruits, les légumes ou comme support pour votre corde à linge.

Veillez à ce que l'abri soit exempt de neige et de feuilles. **La charge maximale supportée est de 90 kg/m<sup>2</sup>.**

Utilisez l'abri uniquement de la manière décrite dans ces instructions de montage.

Le fabricant ou le revendeur déclinent toute responsabilité pour les dommages causés par une utilisation incorrecte ou inappropriée. Ne placez pas l'abri directement sur l'herbe ou sur un terrain inégal, assurez-vous que le sol soit approprié, porteur, horizontal et stable. Nous recommandons de fixer solidement l'abri au sol. Assurez-vous que toutes les vis sont bien serrées et que le cadre est bien aligné et horizontal. Vérifiez régulièrement que toutes les vis sont bien serrées et resserrez-les le cas échéant. **Certaines pièces métalliques sont recouvertes d'un film protecteur.**

**Ce film doit être enlevé avec précaution avant le début du montage.**

## CONSIGNES DE SÉCURITÉ

Ne vous placez jamais directement sur le toit, il y a un risque de surcharge. Et ce que ce soit pour le montage ou pour le nettoyage.

Il existe un danger pour les enfants et les personnes aux capacités physiques, sensorielles ou mentales limitées (par exemple, les personnes surmenées, les personnes partiellement handicapées, les personnes âgées aux capacités physiques et mentales diminuées) ou qui manquent d'expérience et de connaissances (par exemple, les enfants plus âgés). Lors du montage de l'abri, on utilise de petites pièces telles que des écrous et des boulons qui présentent un risque de suffocation en cas d'ingestion.

L'abri de jardin ne doit être monté que par des personnes compétentes, et non par des enfants ou des personnes ayant des capacités mentales ou motrices limitées ou manquant d'expérience.

Une mauvaise manipulation de l'abri peut entraîner des blessures ou des dégâts matériels.

Soyez prudents lors du déballage des différentes pièces. **Il y a un risque de blessure sur les bords tranchants.**

Certains éléments sont en métal, donc lourds. Si vous ouvrez l'emballage sans précautions, par exemple avec un couteau pointu ou un autre objet pointu/affûté, vous risquez d'endommager des éléments. Après avoir déballé les pièces, vérifiez que toutes les pièces individuelles sont disponibles dans les quantités indiquées.

Disposez les différents éléments sur une couverture ou un objet similaire pour éviter de rayer le revêtement.

Vérifiez que les différentes pièces sont en parfait état ou si elles présentent des signes de détérioration, auquel cas n'utilisez pas les éléments endommagés et déformés.

Portez toujours des vêtements de sécurité lors du montage et de l'installation. L'équipement de base comprend des chaussures de sécurité, des gants de protection, des lunettes de sécurité et un casque.

N'installez pas l'abri les jours de grand vent ou de pluie.

Assurez-vous que les éléments ne touchent aucun câble d'alimentation électrique.

Éliminez l'emballage, les sachets en plastique ou les films de protection de manière conforme et tenez-les hors de portée des enfants. Risque de suffocation !

Placez l'abri de jardin sur une surface plane.

Assurez-vous qu'aucun enfant n'est présent dans la zone de danger pendant le montage.

Ne placez pas l'abri dans des zones exposées à des vents forts ou continus.

Pour votre propre sécurité, vous ne devez pas installer le hangar si vous êtes fatigué, ivre ou intoxiqué, ou si vous vous sentez étourdi ou malade.

Si vous utilisez des échelles ou des équipements électroniques, assurez-vous de suivre les instructions d'utilisation du fabricant respectif. Les appareils chauds tels que les grils, les chauffages, les brûleurs, etc. ne doivent pas être utilisés ou stockés dans l'abri de jardin, il y a un risque d'incendie ! Ne restez jamais dans l'abri ou à côté de celui-ci pendant un orage ou une tempête. Il existe un risque de foudroiement.

## ENTRETIEN ET MAINTENANCE

Nettoyez régulièrement la surface. Si vous remarquez des rayures sur la surface, enlevez-les rapidement avec une peinture appropriée. N'utilisez pas de produits de nettoyage agressifs, de brosses avec des pinceaux en métal ou en nylon ou d'outils pointus ou métalliques tels que des couteaux ou des spatules. Utilisez des brosses à poils souples pour le nettoyage. Utilisez de l'eau froide et propre.

## OUTILS ET ÉQUIPEMENTS

Vêtements de sécurité (chaussures de sécurité, gants de protection, lunettes de sécurité, casque, etc.)

Niveau à bulle

Mètre

Escabeau ou échelle double (env. 1,5 m. de hauteur)

Clé simple ou clé à cliquet

Vis pour visseuse et perceuse avec divers. extensions

Tournevis

(non inclus dans la livraison)

FR

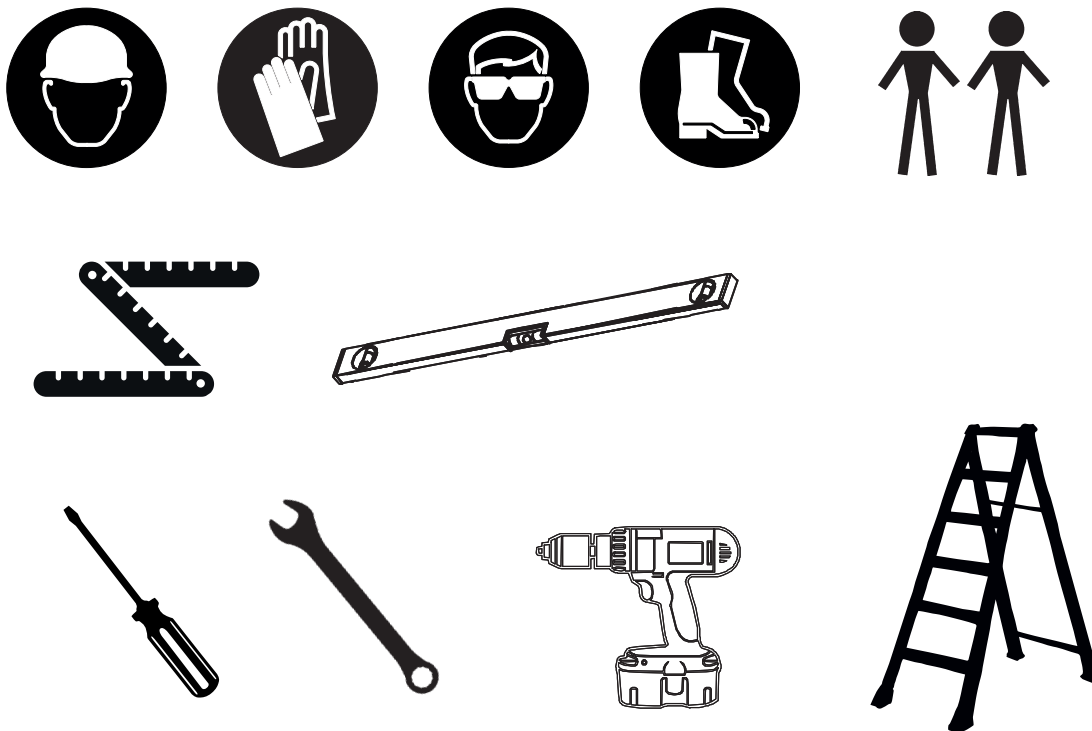

## ÉLIMINATION DES EMBALLAGES

Éliminez les emballages en les triant.

Les cartons sont éliminés comme des déchets de papier et les films d'emballage doivent être affectés à la collecte appropriée des matériaux recyclables.

## MISE AU REBUT DE L'ABRI DE JARDIN





Lors de l'élimination de l'abri de jardin, respectez les directives, les lois et les règlements applicables dans votre pays ou état fédéral en matière d'élimination des déchets.

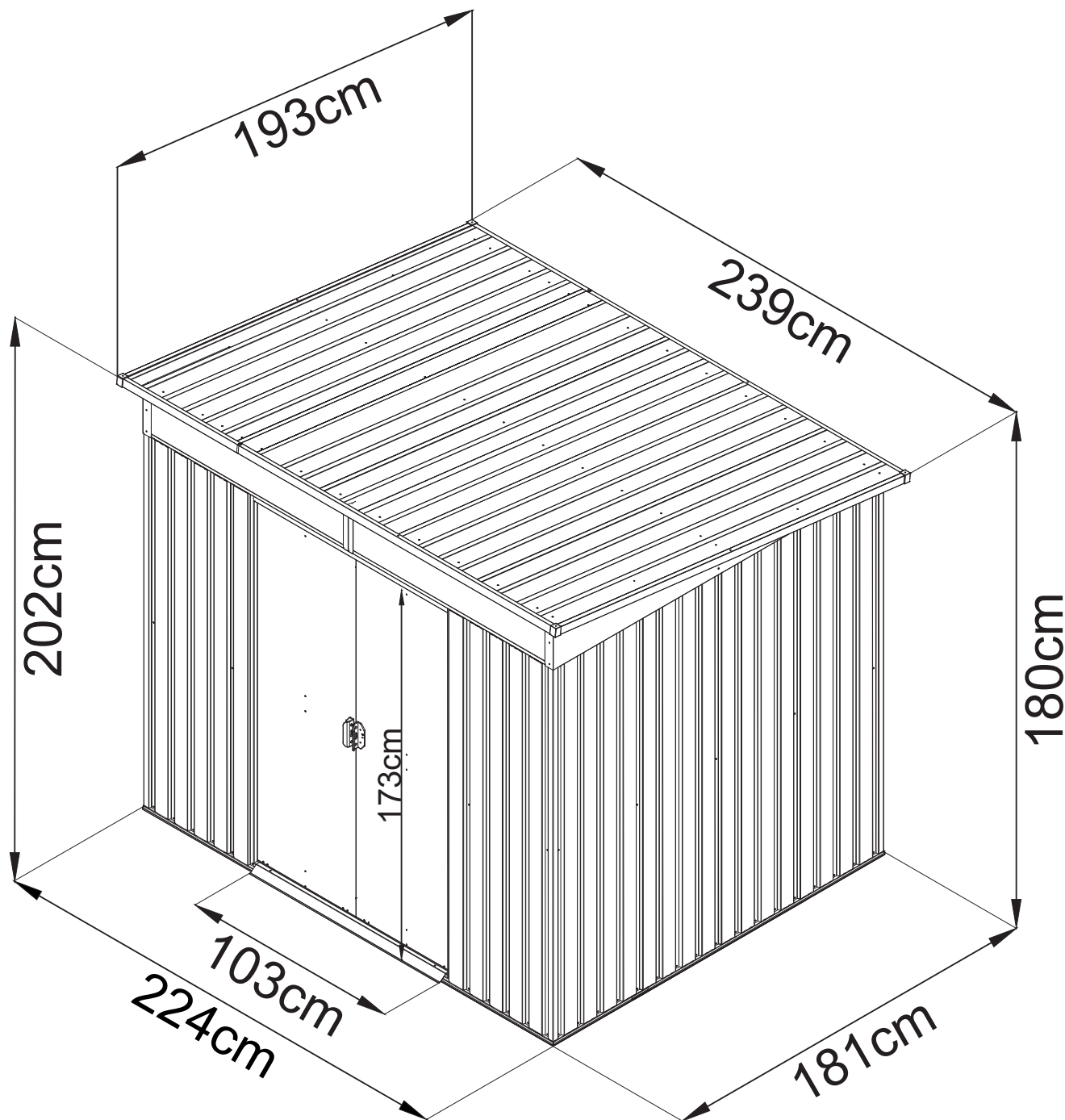



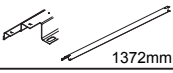
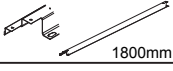
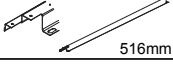
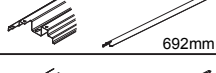
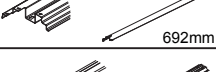
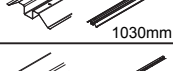
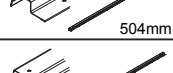
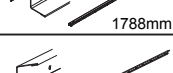
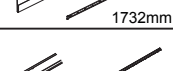
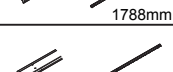
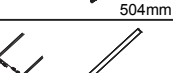
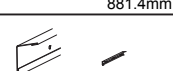

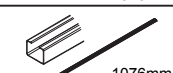
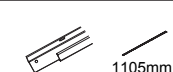
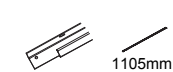
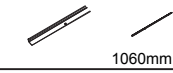
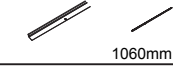
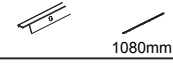
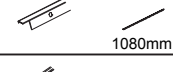
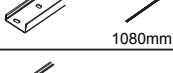
# DIMENSIONS

FR

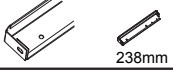
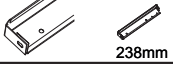
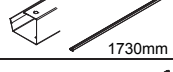
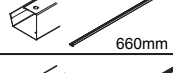
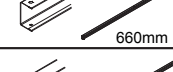
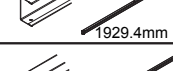
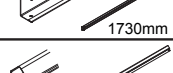
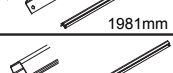
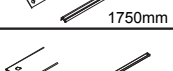
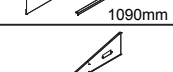
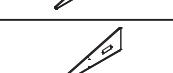

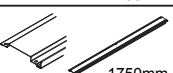
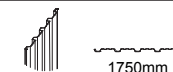

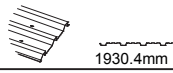
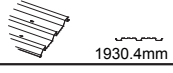
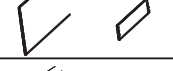
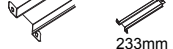









# LISTE DES PIÈCES

N° DE PIÈCE	PIÈCE	QUANTITÉ
1	 1372mm	2
2	 1800mm	1
1-1	 516mm	3
3L	 692mm	1
3R	 692mm	1
5	 1030mm	1
9-1	 504mm	1
9	 1788mm	1
20	 1732mm	2
11	 1788mm	1
11-1	 504mm	1
11-2	 881.4mm	1
B1	 128mm	2
7L	 1076mm	1
7R	 1076mm	1
12L	 1105mm	1
12R	 1105mm	1
14L	 1060mm	1
14R	 1060mm	1
15L	 1080mm	1
15R	 1080mm	1
16L	 1080mm	1
16R	 1080mm	1

N° DE PIÈCE	PIÈCE	QUANTITÉ
19L	 238mm	1
19R	 238mm	1
10	 1730mm	1
10-1	 660mm	1
17-1	 660mm	1
17-2	 1929.4mm	2
17	 1730mm	1
13	 1981mm	2
13-1	 1750mm	2
6	 1090mm	1
21L		1
21R		1
18	 566mm	6
4L	 1750mm	1
4R	 1750mm	1
P1	 1750mm	15
P2	 1930.4mm	2
P3	 1930.4mm	3
P4	 1930.4mm	1
P5		2
22	 233mm	2

# LISTE DES PIÈCES

N° DE PIÈCE	PIÈCE	QUANTITÉ
G2		4
GD		4
GB		2
GC		4
GS		2
F1		310
F2		58
F3		8
S2		167
S3		252

N° DE PIÈCE	PIÈCE	QUANTITÉ
D1	 1740X570mm	1
D2	 1740X570mm	1

FR

# VUE D'ENSEMBLE DU MONTAGE

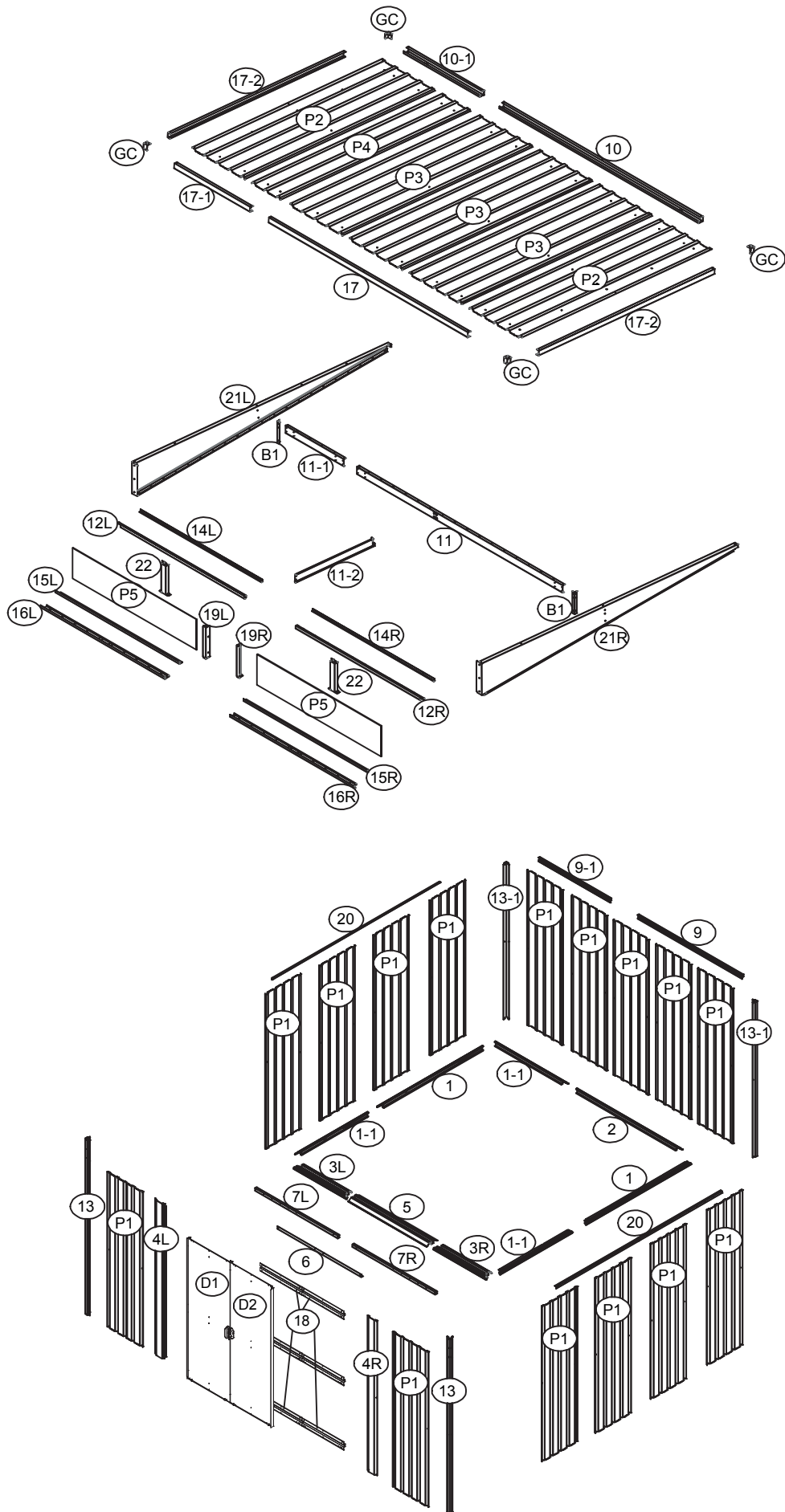



## GEREEDSCHAPSSCHUUR LIGHTLINE MET LESSENAARSDAK BOUWINSTRUCTIES

Afmetingen: L x B x H 239 x 193 x 202 cm

NL

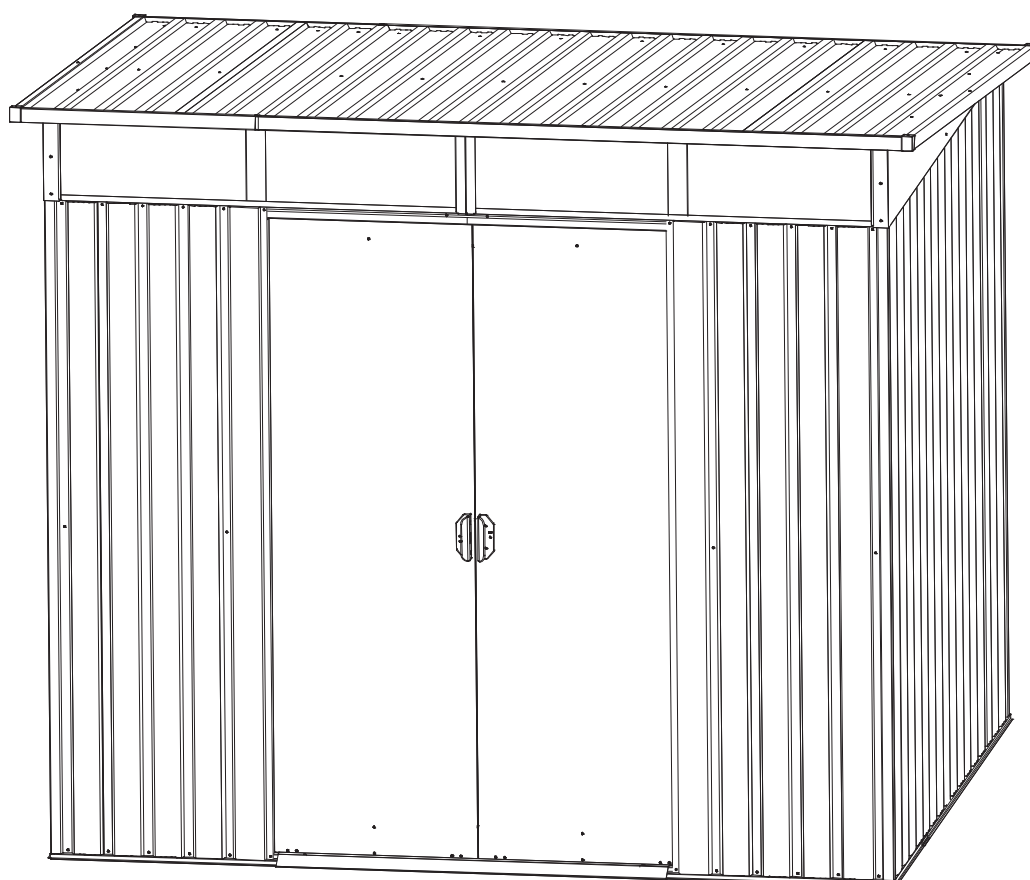

### OPMERKING

Lees de bouwinstructies zorgvuldig door voordat u de gereedschapsschuur gaat bouwen.

Dit geldt in het bijzonder voor de veiligheidsinstructies.

Doet u dit niet, dan kunt u letsel oplopen of de gereedschapsschuur beschadigen.

De gereedschapsschuur is geen klimtoestel voor kinderen en geen klimhulp. Er is een risico op overbelasting.

Zorg dat alle benodigde onderdelen aanwezig zijn in de aangegeven aantallen.

Voer de stappen na elkaar uit, in de volgorde die in deze handleiding staat.

Sla geen stappen of onderdelen van stappen over.

Bewaar de bouwinstructies op een veilige plek zodat u ze er later weer bij kunt pakken.

## ALGEMENE INFORMATIE

Zorg voordat u met de montage begint dat er wordt voldaan aan alle geldende richtlijnen en wetten.

Maak voor de montage minimaal 390 tot 450 minuten tijd vrij.

Voor de montage zijn minimaal 2 personen nodig. Controleer voordat u begint of alle onderdelen in de juiste aantallen aanwezig zijn. Gebruik voor het bouwen een vrije, zonnige plek zonder overhangende takken.

Controleer voor de montage of alle onderdelen volledig intact zijn en leg ze zo neer dat ze tijdens het werk goed bereikbaar zijn.

U kunt kleine onderdelen zoals schroeven en moeren het beste in een bakje leggen zodat u ze niet kwijtraakt.

Gebruik de gereedschapsschuur nooit als klimhulp voor peulvruchten, klim- en slingerplanten, groente of fruit of als steunpunt voor uw waslijn.

Hou de gereedschapsschuur vrij van sneeuw en bladeren. **De maximale draaglast is 90 kg/m<sup>2</sup>.**

Gebruik de gereedschapsschuur alleen zoals in deze montagehandleiding omschreven staat.

De fabrikant of verkoper is niet aansprakelijk voor schade die voortvloeit uit abnormaal of onjuist gebruik.

Zet de gereedschapsschuur niet rechtstreeks op gras of ongelijke ondergronden.

Zorg voor een geschikte, sterke, vlakke en stabiele ondergrond.

We raden aan om de gereedschapsschuur stevig te verankeren in de bodem. Zorg dat alle schroeven stevig zijn aangehaald en dat het frame correct en waterpas staat. Controleer regelmatig of alle schroeven stevig vastzitten en draai ze waar nodig weer vast.

**Een aantal metalen onderdelen is voorzien van beschermfolie. Deze folie moet voor het begin van de montage zorgvuldig worden verwijderd.**

## VEILIGHEIDSINSTRUCTIES

Ga nooit rechtstreeks op het dak staan, er bestaat risico op overbelasting. Doe dit ook niet tijdens de montage of om schoon te maken.

Er is een risico voor kinderen en personen met beperkte lichamelijke, zintuiglijke of geestelijke vaardigheden (bijvoorbeeld oververmoeide personen, mensen met een gedeeltelijke beperking of oudere personen met verminderde lichamelijke en geestelijke vaardigheden) of met beperkte ervaring en kennis (bijvoorbeeld oudere kinderen).

Bij de montage van de gereedschapsschuur worden kleine onderdelen gebruikt, zoals schroeven en moeren.

Deze brengen bij inslikken een verstikkingsgevaar met zich mee.

De gereedschapsschuur mag alleen worden gebouwd door deskundige personen, en niet door kinderen of door personen met beperkte geestelijke of motorische vaardigheden of met een gebrek aan ervaring.

Onjuist gebruik van de gereedschapsschuur kan letsel of schade veroorzaken.

Wees voorzichtig bij het uitpakken van de afzonderlijke onderdelen uit de verpakking. **Er is een risico op letsel door scherpe randen.** Sommige onderdelen zijn van metaal en zijn daardoor zwaar. Als u de verpakking niet voorzichtig opent, bijvoorbeeld door een scherp mes of een ander scherp of spits voorwerp te gebruiken, is er een risico dat u onderdelen beschadigt. Controleer na het uitpakken of alle onderdelen aanwezig zijn in de juiste aantallen.

Leg de losse onderdelen op een deken of een soortgelijke ondergrond om krassen in de coating te voorkomen.

Controleer of alle onderdelen volledig intact zijn en niet beschadigd zijn. In dat laatste geval dient u de beschadigde, vervormde onderdelen niet te gebruiken.

Draag altijd veiligheidskleding tijdens de bouw en de montage. De basisuitrusting bestaat uit veiligheidsschoenen, veiligheidshandschoenen, een veiligheidsbril en een helm.

Installeer de gereedschapsschuur niet op dagen met veel regen of wind.

Zorg dat de onderdelen niet in contact komen met stroomkabels.

Verpakking, kunststof zakje of beschermfolie correct verwijderen en deze buiten het bereik van kinderen houden, verstikkingsgevaar!

Zet de gereedschapsschuur op een vlakke ondergrond.

Zorg dat er tijdens de montage geen kinderen aanwezig zijn in de gevarenzone.

Zet de gereedschapsschuur niet op plekken die worden blootgesteld aan harde of continue wind.

Voor uw eigen veiligheid wordt afgeraden om de gereedschapsschuur te bouwen als u moe, beschonken of onder invloed bent of als u zich duizelig of niet goed voelt.

Als u ladders of elektronische apparaten gebruikt, zorg dan dat u zich houdt aan de gebruiksinstructies van de betreffende fabrikant. Gebruik en bewaar geen hete apparatuur in de gereedschapsschuur, zoals barbecues, verwarmingstoestellen en branders. Hierbij bestaat brandgevaar! Ga bij onweer niet in of naast de gereedschapsschuur staan. Er is een risico op blikseminslag.

## VERZORGING EN ONDERHOUD

Maak de oppervlakken regelmatig schoon. Ziet u krassen in het oppervlak, repareer deze dan onmiddellijk met geschikte lak. Gebruik geen agressieve schoonmaakmiddelen, borstels met metalen of nylon haren, of scherpe of metalen hulpmiddelen zoals messen of spatels. Gebruik bij het schoonmaken zachte borstels.

Gebruik koud en schoon water.

## GEREEDSCHAPPEN EN UITRUSTING

Veiligheidskleding (veiligheidsschoenen, veiligheidshandschoenen, veiligheidsbril, helm et)

Waterpas

Meetlat

Trapladder (hoogte ca. 1,5 m)

Schroef- of ratelsleutel

Accuschroef- en boormachine met verschillende hulpstukken

Schroevendraaier

(niet inbegrepen)

NL



## AFVOER VAN DE VERPAKKING

Voer de verpakkingsonderdelen gescheiden af.

Doe papier en karton bij het oud papier en doe folie

in de betreffende recyclingbak.

## AFVOER VAN DE GEREEDSCHAPSSCHUUR





Let bij het afvoeren van de gereedschapsschuur op de afvoerrichtlijnen, -wetten en -bepalingen voor uw land of regio.

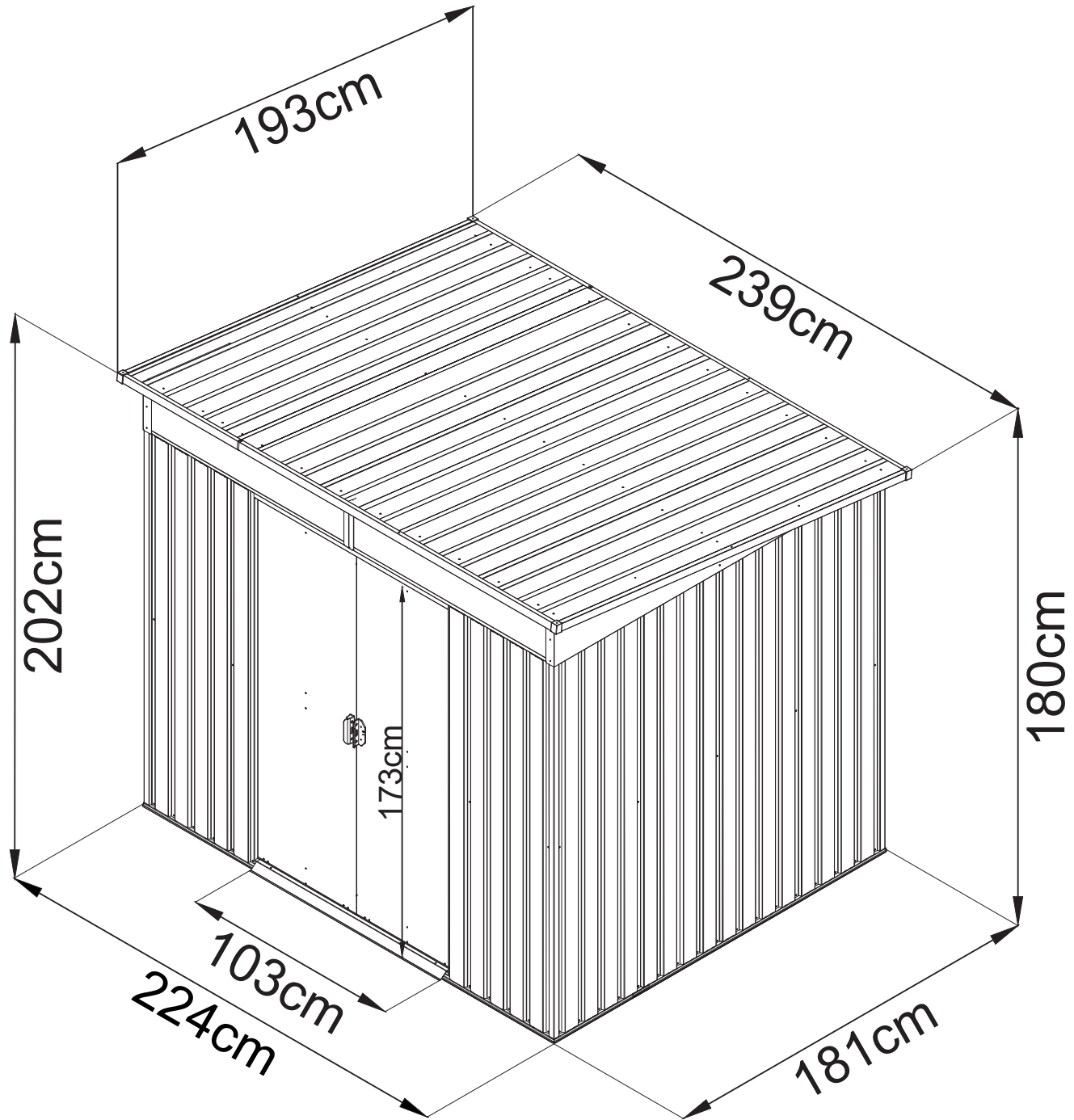



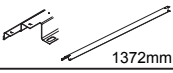
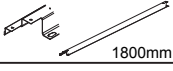
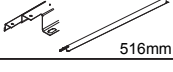
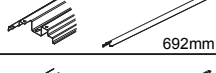
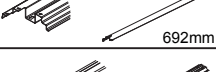
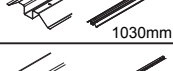
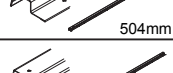
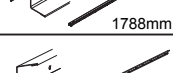
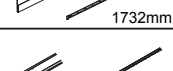
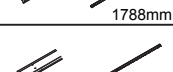
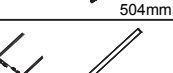
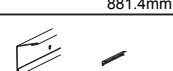

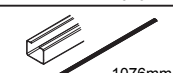
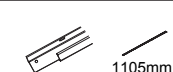
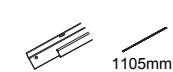
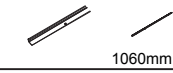
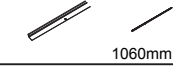
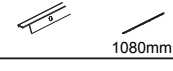
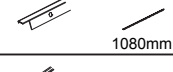
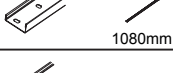
# AFMETINGEN

NL

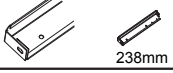
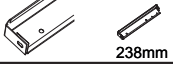
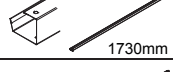
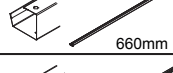
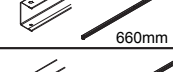
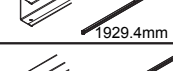
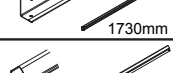
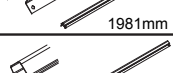
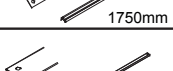
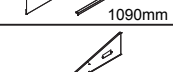
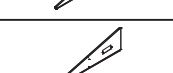

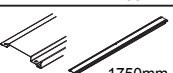
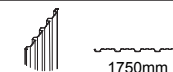

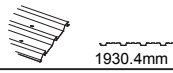
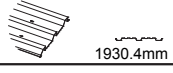
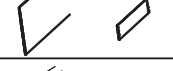
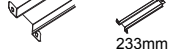









# ONDERDELENLIJST

NR.	ONDERDEEL	HOEEVEELHEID
1	 1372mm	2
2	 1800mm	1
1-1	 516mm	3
3L	 692mm	1
3R	 692mm	1
5	 1030mm	1
9-1	 504mm	1
9	 1788mm	1
20	 1732mm	2
11	 1788mm	1
11-1	 504mm	1
11-2	 881.4mm	1
B1	 128mm	2
7L	 1076mm	1
7R	 1076mm	1
12L	 1105mm	1
12R	 1105mm	1
14L	 1060mm	1
14R	 1060mm	1
15L	 1080mm	1
15R	 1080mm	1
16L	 1080mm	1
16R	 1080mm	1

NR.	ONDERDEEL	HOEEVEELHEID
19L	 238mm	1
19R	 238mm	1
10	 1730mm	1
10-1	 660mm	1
17-1	 660mm	1
17-2	 1929.4mm	2
17	 1730mm	1
13	 1981mm	2
13-1	 1750mm	2
6	 1090mm	1
21L		1
21R		1
18	 566mm	6
4L	 1750mm	1
4R	 1750mm	1
P1	 1750mm	15
P2	 1930.4mm	2
P3	 1930.4mm	3
P4	 1930.4mm	1
P5		2
22	 233mm	2

## ONDERDELENLIJST

NR.	ONDERDEEL	HOEEVELHEID
G2		4
GD		4
GB		2
GC		4
GS		2
F1		310
F2		58
F3		8
S2		167
S3		252

NR.	ONDERDEEL	HOEEVELHEID
D1	 1740X570mm	1
D2	 1740X570mm	1

NL

# MONTAGEOVERZICHT

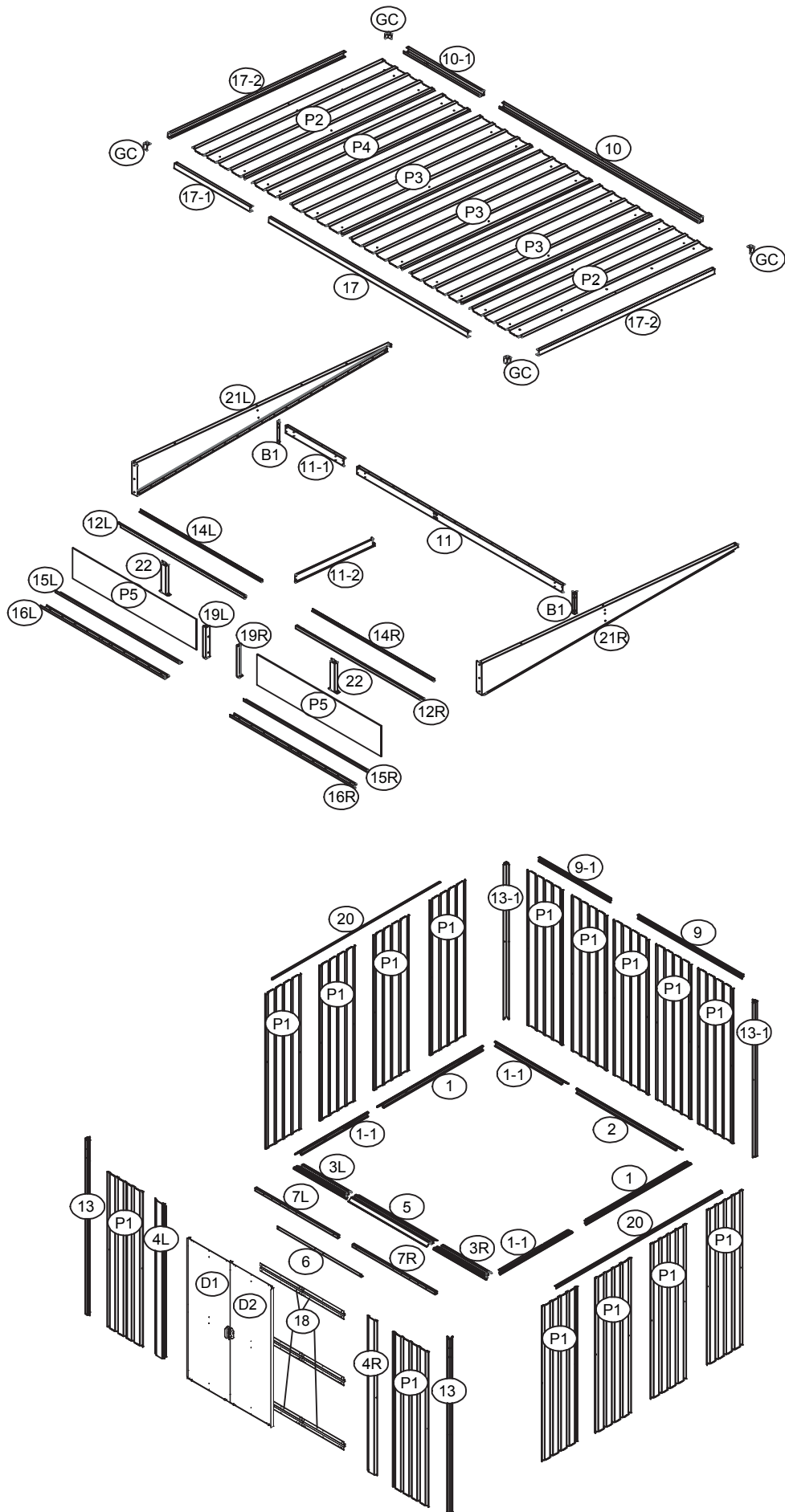

## FÉSZER FÉLNYEREGTETŐVEL LIGHTLINE SZERELÉSI ÚTMUTATÓ

Méret: H x Szé x Ma 239 x 193 x 202 cm

HU

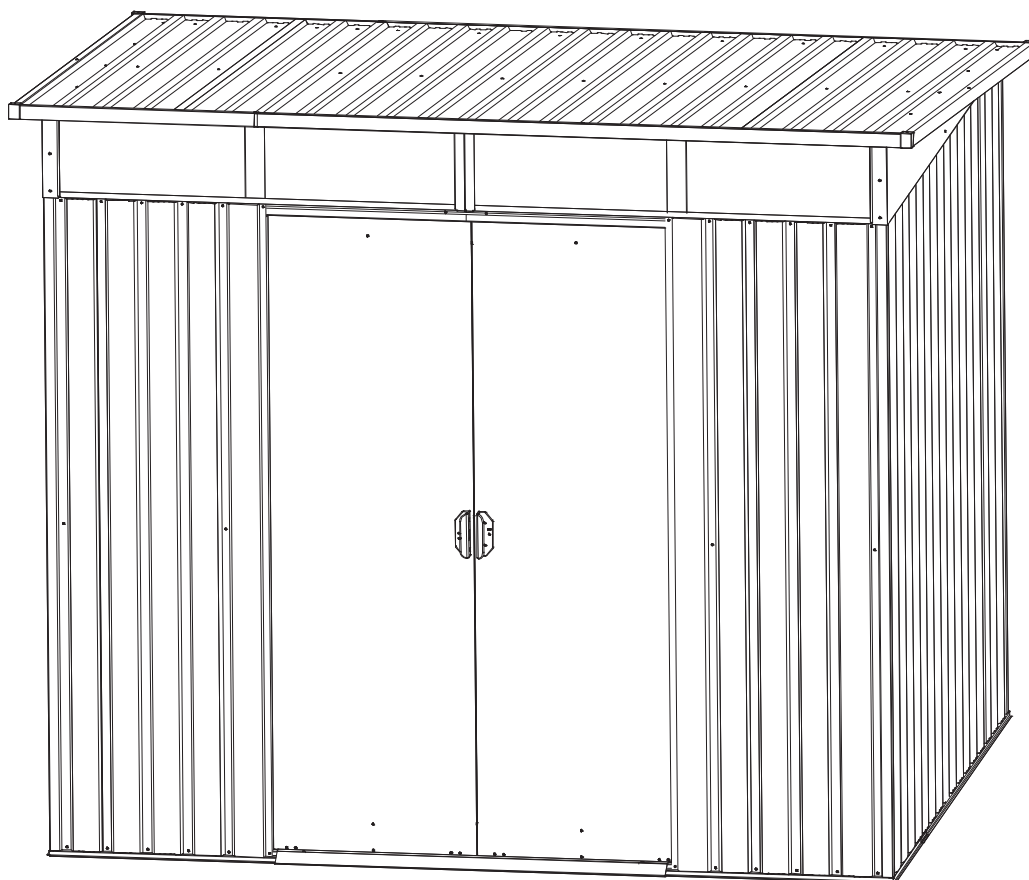

### ÉRTESÍTÉS:

Olvassa el figyelmesen a szerelési útmutatót, mielőtt hozzáfog a kerti fészter összeszereléséhez.

Ez különösen érvényes a biztonsági utasításokra.

Ellenkező esetben megsérülhet vagy megrongálhatja a fésztert.

A kerti fészter nem gyerekek részére szánt mászóka és nem kúszórács. Fennáll a túlterhelés veszélye.

Győződjön meg arról, hogy minden szükséges szerkezeti elem a megadott mennyiségben áll rendelkezésre.

Az összeszerelés lépéseit egymás után és a megadott sorrendben hajtsa végre a jelen útmutatóban megadottak szerint.

A megadott lépések egyikét se ugorja át vagy rövidítse le.

Ahhoz, hogy későbbi időpontban elővehesse, őrizze meg biztonságos helyen a szerelési útmutatót.



## ÁLTALÁNOS INFORMÁCIÓK:

Az összeszerelés megkezdése előtt győződjön meg arról, hogy betartja a megfelelő irányelveket/törvényeket.

Az összeszereléshez legalább 390 - 450 perccel számoljon.

Az összeszereléshez legalább 2 személy szükséges. A munkavégzés megkezdése előtt ellenőrizze, hogy minden alkatrész megfelelő mennyiségben áll-e rendelkezésre. Az összeszerelést szabad, napos felületen végezze, ahol nem állnak ki ágak.

Az összeszerelés megkezdése előtt ellenőrizze az egyes szerkezeti elemek épségét, és úgy helyezze el azokat, hogy a szerkezeti elemeket könnyen elérje a munkavégzés során.

A legjobb, ha az apró alkatrészeket, például a csavart, anyát stb. egy tálban tárolja, hogy ne vesszenek el.

A kerti fészter semmi esetre se használja kúszórácsként hüvelyesek, futó- és kúszónövények, gyümölcs, zöldség esetén vagy ruhaszáritó kötél tartójaként.

Szabadítsa meg a kerti fészter a hótól és a lombtól. **A legnagyobb teherbírás 90 kg/m<sup>2</sup>.**

A kerti fészter kizárólag a jelen szerelési útmutatóban leírtak szerint használja.

A gyártó vagy a kereskedő nem vállal felelősséget olyan károkért, amelyek a rendeltetésellenes vagy hibás használat miatt következnek be. Ne állítsa a kerti fészter közvetlenül a fűre vagy egyenetlen talajra, gondoskodjon a megfelelő teherbíró képességgel rendelkező vízszintes és stabil aljzatról. Javasoljuk, hogy rögzítse a kerti fészter szilárdan a talajhoz. Győződjön meg arról, hogy minden csavart szilárdan meghúzott és helyes irányban és vízszintesen áll a keret. Ellenőrizze rendszeresen, hogy szilárdan meghúzott minden csavart és szükség esetén húzza után azokat.

**Némely fém alkatrészt védőfóliával láttunk el. Ezt a fóliát a szerelés megkezdése előtt el kell távolítani.**

## BIZTONSÁGI UTASÍTÁSOK:

Soha ne álljon közvetlenül a tetőfelületre, mert fennáll a túlterhelés veszélye. Még összeszerelés és tisztítás közben sem. Gyerekek és korlátozott fizikai, érzékszervi vagy mentális képességekkel rendelkező személyek (pl. túlságosan fáradt személyek, részben fogyatékos személyek, csökkent fizikai és szellemi képességgel rendelkező idősebb személyek) esetén vagy tapasztalat és tudás hiányában (pl. idősebb gyerekek) veszély áll fenn. A kerti fészter szereléséhez apró alkatrészek, például csavarok és anyák használatosak, amelyek lenyeléskor fulladásveszélyt okozhatnak.

A kerti fészter kizárólag szakavatott személy építheti fel, gyerekek vagy korlátozott szellemi és motorikus képességű vagy kevés tapasztalattal rendelkező személyek nem.

A kerti fészter nem szakszerű használata sérüléshez vagy anyagi kárhoz vezethet.

Vigyázzon az egyes szerkezeti elemek csomagolásból való kicsomagolásakor. **Az éles élek mentén balesetveszély áll fenn.**

Az egyes szerkezeti elemek fémből vannak, ezért nehezek. Ha nem óvatosan nyitja ki a csomagolást, például éles késsel vagy egyéb éles/hegyes tárggyal fennáll a veszélye, hogy megséríti a szerkezeti elemet. A részegységek kicsomagolását követően ellenőrizze, hogy minden szerkezeti elem megfelelő mennyiségben áll-e rendelkezésre.

A bevonat karcolásának megakadályozása érdekében helyezze az egyes alkatrészeket egy takaróra vagy hasonlóra.

Ellenőrizze, hogy az egyes szerkezeti elemek kifogástalan állapotúak vagy sérültek-e. Ha igen, ne használja a sérült, deformált szerkezeti elemeket.

Az összeszerelés és a szerelés során mindig viseljen biztonsági ruházatot. Az alapfelszereléshez tartozik a biztonsági lábbeli, védőkesztyű, védőszemüveg és a sisak.

Ne erősen szeles vagy esős napon állítsa fel a kerti fészter.

Győződjön meg arról, hogy a szerkezeti elemek nem érintkeznek elektromos vezetékkel.

A csomagolást, műanyag tasakot vagy a védőfóliát szakszerűen ártalmatlanítsa és tartsa azokat gyerekektől távol, fulladásveszély!

A kerti fészter egyenes felületre állítsa.

Győződjön meg arról, hogy az összeszerelés során ne tartózkodjanak gyerekek a veszélyzónában.

Ne helyezze a kerti fészter olyan területekre, ahol azt erős vagy folyamatos szél éri.

Személyes biztonsága érdekében ne szerelje össze a kerti fészter, ha fáradt, alkoholt fogyasztott vagy kábítószer hatása alatt áll stb., illetve ha úgy érzi, szédül vagy rosszul érzi magát.

Ha létrát vagy elektromos készüléket használ, győződjön meg arról, hogy betartja a felhasználásra vonatkozó gyártói adatokat. A tűzveszély miatt forró készülékek, például grillsütő, fűtőkészülékek stb. nem használhatók vagy tárolhatók a fészterben! Rossz idő vagy zivatar esetén soha ne álljon a fészterbe vagy a fészter mellé. Fennáll a villámcsapás veszélye.

## ÁPOLÁS ÉS ÁLLAGMEGÓVÁS:

Tisztítsa meg rendszeresen a felületet. Amennyiben a felületen karcolást észlel, megfelelő lakk segítségével azonnal távolítsa el azt.

Ne használjon maró tisztítószeret, fém- vagy nejlonsörtéjű kefét, valamint éles vagy fém segédeszközt, például kést vagy spatulát. Tisztításhoz puha sörtét használjon. Használjon hideg, tiszta vizet.

## SZERSZÁM ÉS FELSZERELÉS:

Biztonsági ruházat (biztonsági lábbeli, védőkesztyű, védőszemüveg, kobak stb.)

Vízmérték

Hosszmérő

Kétágú létra (kb. 1,5 m magas)

Csavar- vagy racsnis kulcsot

Akkumulátoros csavarhúzó és fúrógép különböző rátétel

Csavarhúzó

(nem tartozik a készülékhez mellékelt tartozékok közé)

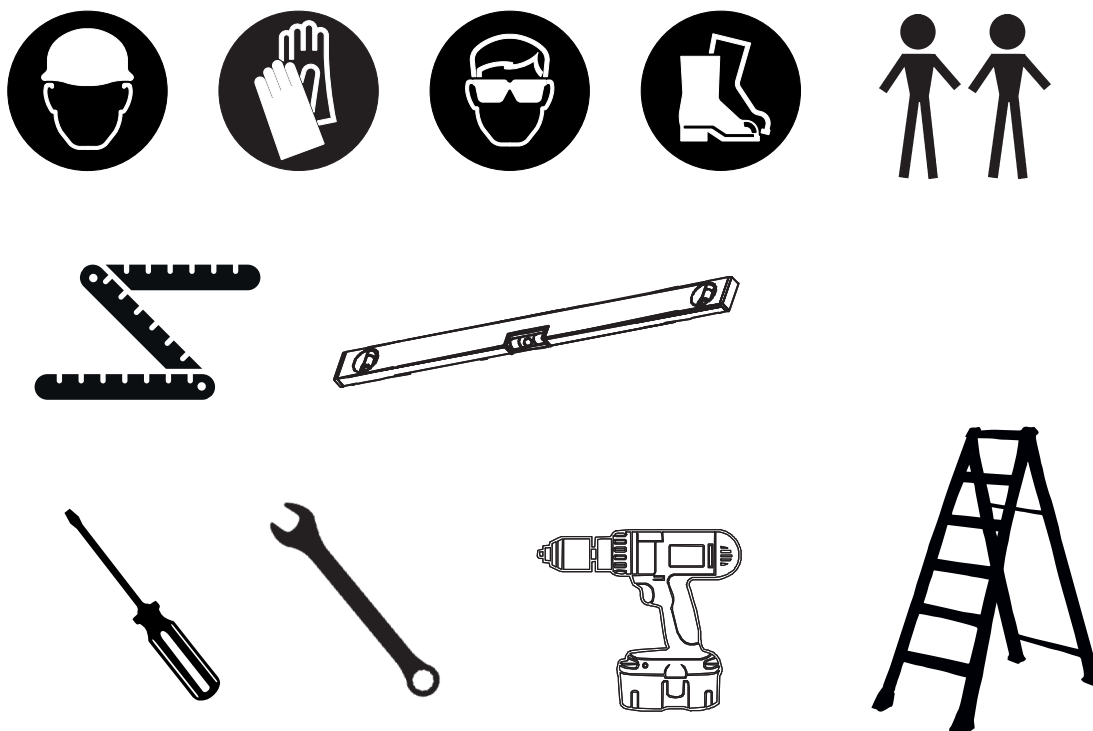

## A CSOMAGOLÁS ÁRTALMATLANÍTÁSA:

A csomagolást fajtánként szétválogatva ártalmatlanítsa.

A hullámpapír és a kartonpapír ártalmatlanítása papírhulladékként, és a fóliát vigye a megfelelő gyűjtőhelyre

## A FÉSZER ÁRTALMATLANÍTÁSA:



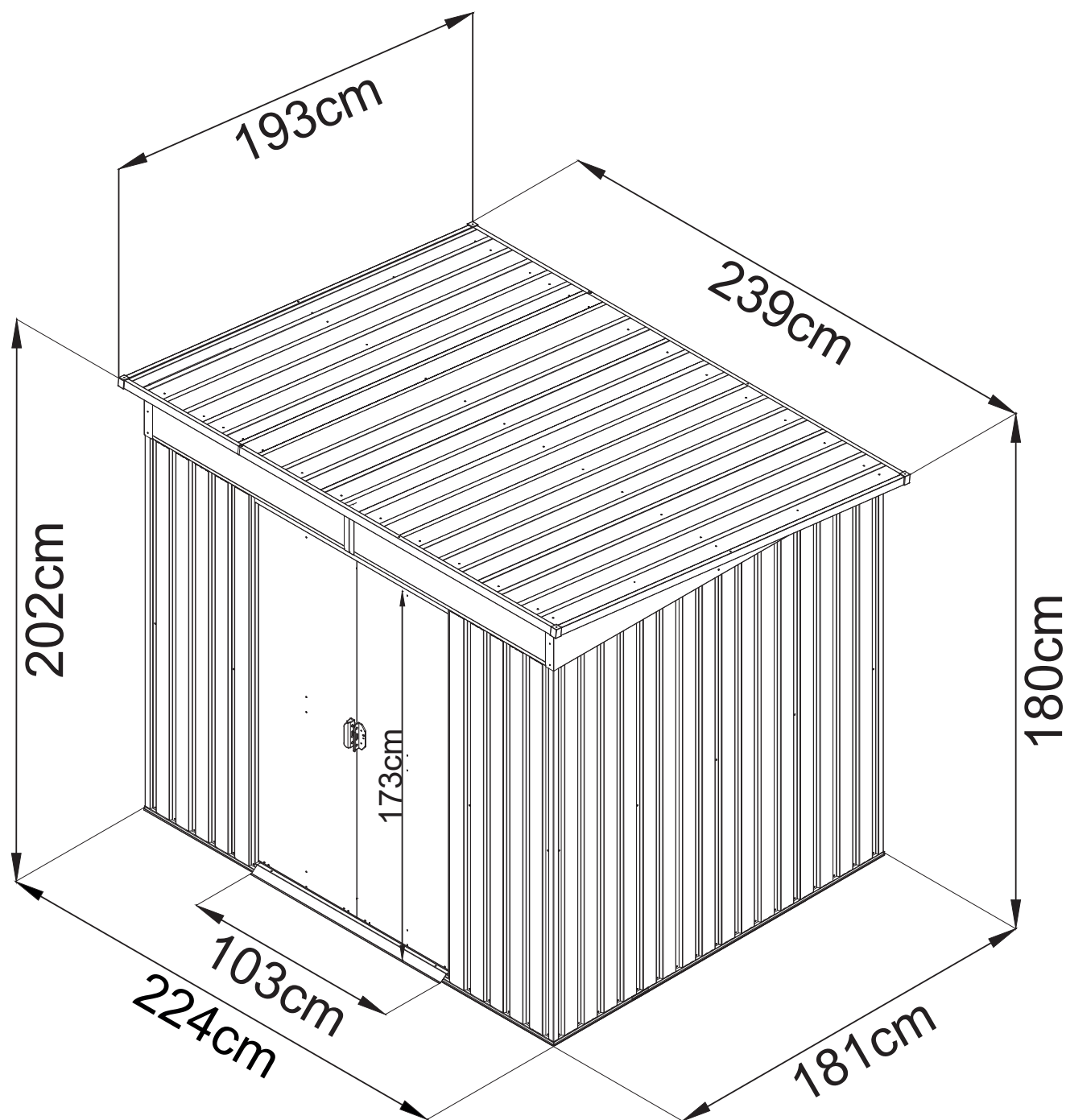

A fészert ártalmatlanításánál ügyeljen az Ön országában vagy tartományában az ártalmatlanításra vonatkozóan érvényes irányelvekre, törvényekre és rendelkezésekre.





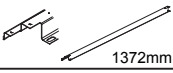
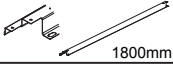
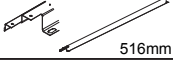
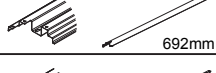
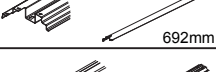
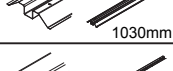
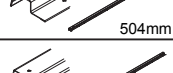
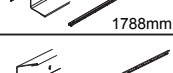
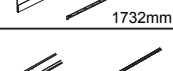
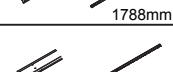
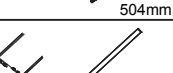
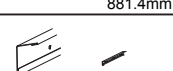

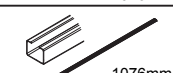
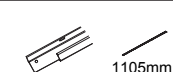
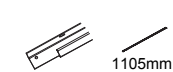
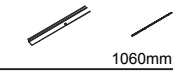
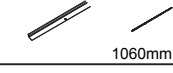
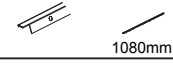
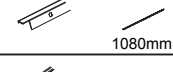
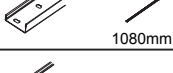
# MÉRETEK



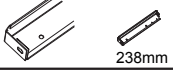
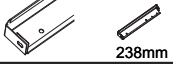
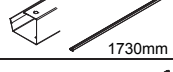
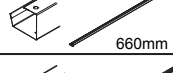
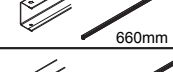
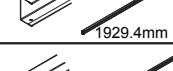
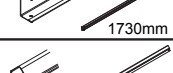
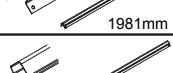
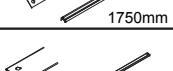
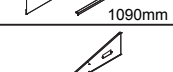
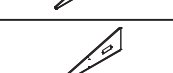

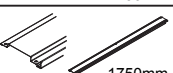
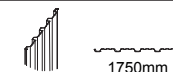

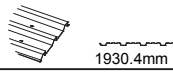
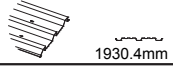
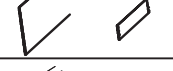
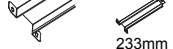





HU



# ALKATRÉSZLISTA

SZ.	ALKATRÉSZ	MENNYISÉG
1	 1372mm	2
2	 1800mm	1
1-1	 516mm	3
3L	 692mm	1
3R	 692mm	1
5	 1030mm	1
9-1	 504mm	1
9	 1788mm	1
20	 1732mm	2
11	 1788mm	1
11-1	 504mm	1
11-2	 881.4mm	1
B1	 128mm	2
7L	 1076mm	1
7R	 1076mm	1
12L	 1105mm	1
12R	 1105mm	1
14L	 1060mm	1
14R	 1060mm	1
15L	 1080mm	1
15R	 1080mm	1
16L	 1080mm	1
16R	 1080mm	1

SZ.	ALKATRÉSZ	MENNYISÉG
19L	 238mm	1
19R	 238mm	1
10	 1730mm	1
10-1	 660mm	1
17-1	 660mm	1
17-2	 1929.4mm	2
17	 1730mm	1
13	 1981mm	2
13-1	 1750mm	2
6	 1090mm	1
21L		1
21R		1
18	 566mm	6
4L	 1750mm	1
4R	 1750mm	1
P1	 1750mm	15
P2	 1930.4mm	2
P3	 1930.4mm	3
P4	 1930.4mm	1
P5		2
22	 233mm	2

# ALKATRÉSZLISTA

SZ.	ALKATRÉSZ	MENNYISÉG
G2		4
GD		4
GB		2
GC		4
GS		2
F1		310
F2		58
F3		8
S2		167
S3		252

SZ.	ALKATRÉSZ	MENNYISÉG
D1	 1740X570mm	1
D2	 1740X570mm	1

HU

# SZERELÉS ÁTTEKINTÉSE

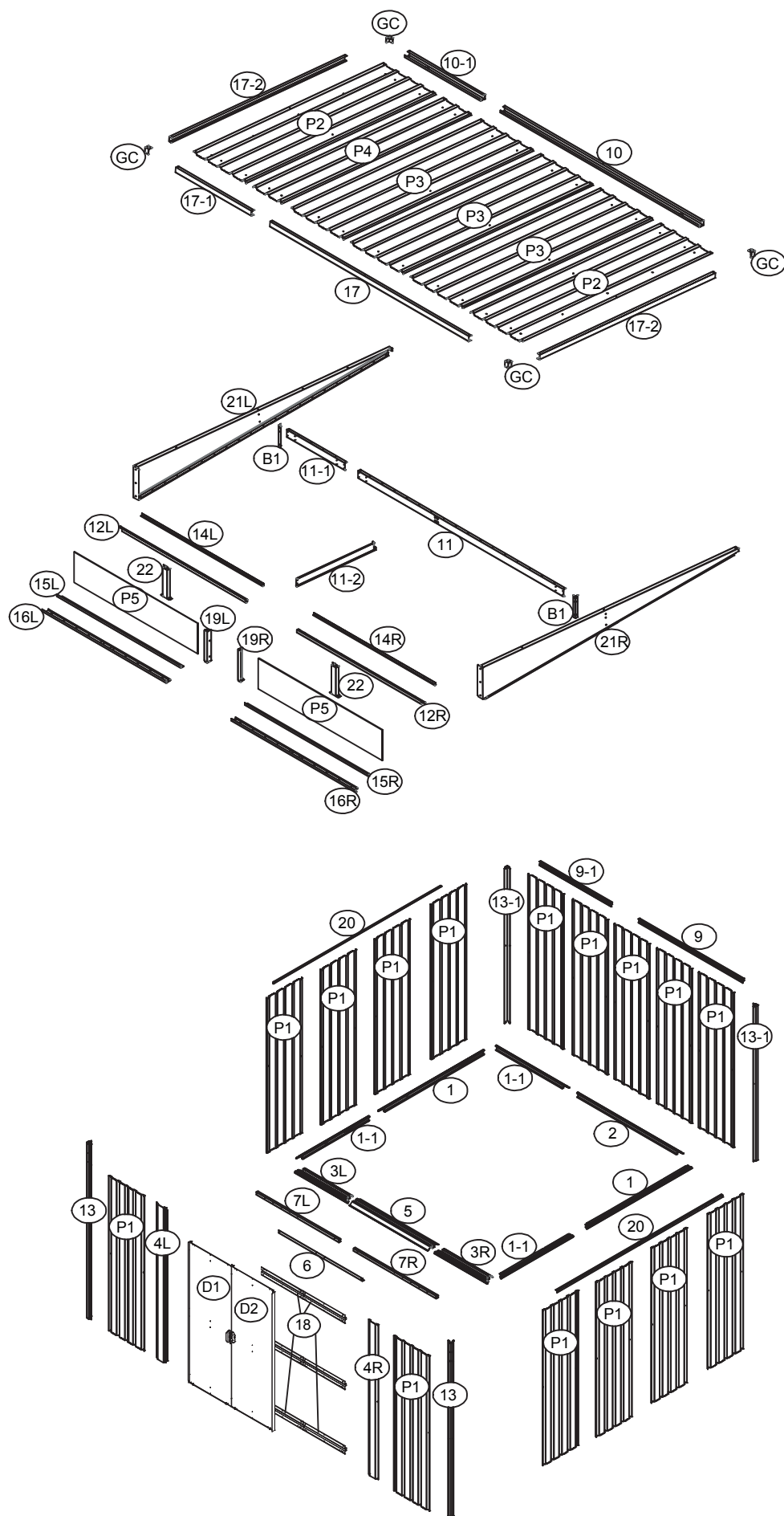

## MAGAZIE CU ACOPERIȘ TIP TERASĂ LIGHTLINE INSTRUCȚIUNI DE ASAMBLARE

Dimensiuni: L x l x H 239 x 193 x 202 cm

RO

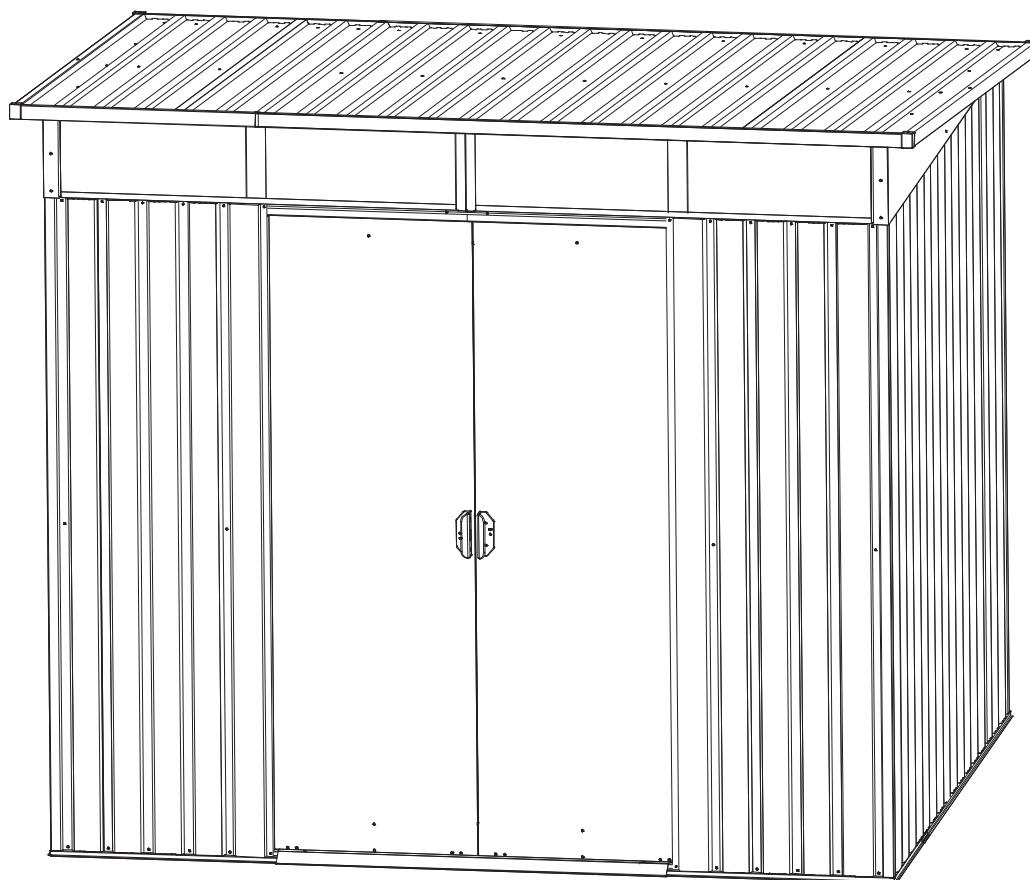

### INDICAȚIE

Citiți cu atenție instrucțiunile de asamblare înainte de a începe asamblarea magaziei.  
Se aplică în special instrucțiunilor de siguranță.  
Altfel, vă puteți răni sau puteți deteriora dispozitivul.  
Magazia nu este un obiect pe care se pot cățăra copiii și nici scară. Există riscul de răsturnare.  
Asigurați-vă că toate piesele componente sunt disponibile în cantitatea prevăzută.  
Urmați pașii de asamblare individuali și în ordinea corectă, așa cum sunt precizate în aceste instrucțiuni.  
Vă rugăm să nu omiteți niciun pas și să nu scurtați succesiunea lor.  
Păstrați instrucțiunile de asamblare într-un loc sigur, pentru a le putea recupera cu ușurință mai târziu.

## INFORMAȚII GENERALE

Înainte de a începe montajul, asigurați-vă că sunt respectate directivele/legile aplicabile pentru dumneavoastră. Planificați între 390 și 450 de minute pentru montaj.

Sunt necesare minim 2 persoane. Înainte de începerea lucrului, verificați dacă toate piesele sunt disponibile în cantitatea corectă. Folosiți o suprafață liberă, înșorită, fără crengi deasupra, pentru montaj.

Verificați piesele individuale înainte de începerea montajului, pentru integritate, și așezați-le astfel încât să fie ușor de luat în timpul lucrului.

Se recomandă păstrarea pieselor mici, precum șuruburile, piulițele etc. într-o cutie, pentru a evita pierderea acestora. Nu folosiți în niciun caz magazia ca suport pentru legume, plante agățătoare sau în ghiveci și fructe, și nici ca uscător pentru haine.

Nu permiteți magaziei să fie acoperită de zăpadă și frunze. **Capacitatea portantă max. este de 90 kg/m<sup>2</sup>.**

Utilizați magazia exclusiv conform descrierii din aceste instrucțiuni pentru montaj.

Producătorul sau comerciantul nu își asumă răspunderea pentru daune survenite în urma utilizării neconforme sau greșite. Nu așezați magazia direct pe iarbă sau pe un teren denivelat.

Asigurați-vă că solul este adecvat, portant, orizontal și stabil. Recomandăm ancorarea sigură a magaziei în pământ.

Asigurați-vă că toate șuruburile sunt strânse și că rama este corect orientată și orizontală. Verificați regulat că toate șuruburile sunt strânse bine și ajustați-le dacă este necesar.

**Unele componente metalice sunt prevăzute cu o folie de protecție. Această folie trebuie să fie îndepărtată cu grijă înainte de începerea montajului.**

## INDICAȚII DE SIGURANȚĂ

Nu vă așezați niciodată direct pe acoperiș, există pericolul de a-l suprasolicita. Valabil și în timpul montajului sau curățării.

Există un pericol pentru copii și persoanele cu capacități fizice, senzoriale sau mentale reduse (de ex. persoane extenuate, cu dizabilități parțiale, cu vârste înaintate și capacități fizice și mentale reduse) sau cu experiență și cunoștințe reduse (de ex. copii mai mari). La montajul magaziei se folosesc piese mici, cum ar fi șuruburile și piulițele, care prezintă risc de înghițire și sufocare.

Magazia se poate construi doar de către persoane cu expertiză suficientă, nu de către copii sau persoane cu capacități spirituale sau motrice reduse, sau cu o experiență redusă.

Manevrarea inadecvată a magaziei poate provoca răniri sau deteriorări ale obiectelor.

Când despachetați piesele componente individuale, atenție la ambalaj. **Există un pericol de rănire generat de muchiile ascuțite.** Piesele individuale sunt confecționate din metal și sunt grele. În cazul deschiderii neglijente a ambalajului, de exemplu folosind un cuțit ascuțit sau un alt obiect ascuțit/tăios prezintă pericolul de a deteriora piesele componente. După despachetare, verificați dacă toate piesele individuale sunt în cantitatea corespunzătoare. Așezați piesele individuale pe o suprafață plană, pentru a evita zgârierea.

Verificați dacă piesele individuale sunt în stare bună sau dacă prezintă deteriorări, caz în care vă rugăm să nu folosiți piesele deteriorate sau deformat.

În timpul asamblării și montajului, vă rugăm să purtați permanent îmbrăcăminte de protecție. Echipamentul de bază include încălțăminte de siguranță, mănuși, ochelari de protecție și cască.

Nu instalați magazia în zile cu mult vânt sau ploioase.

Asigurați-vă că piesele componente nu ating niciun cablu sub tensiune.

Eliminați corespunzător ambalajul, punga de plastic sau foliile de protecție, și păstrați-le în locuri în care nu au acces copiii. Prezintă risc de sufocare!

Așezați magazia pe o suprafață plată.

Asigurați-vă că, în timpul montajului, nu sunt prezenți copii în zona de pericol.

Nu amplasați magazia în zone care sunt expuse vântului puternic sau de durată.

Pentru siguranța personală, nu construiți magazia când sunteți obosit, ați consumat alcool sau sunteți în stare de ebrietate, resp. dacă vă simțiți amețit sau vă este rău.

Dacă utilizați cabluri sau dispozitive electronice, asigurați-vă că respectați indicațiile producătorului.

Dispozitivele fierbinț, cum ar fi grătarele, dispozitivele de încălzire, arzătoarele etc. nu se vor folosi în magazie și nici nu vor fi depozitate acolo - pericol de incendiu! Pe vreme rea sau în condiții meteorologie nefavorabile, nu stați în interiorul sau în proximitatea magaziei. Există riscul să fiți lovit de fulger.

## ÎNTREȚINERE ȘI ÎNGRIJIRE

Curățați regulat suprafețele. Dacă remarcați zgârieturi pe suprafețe, înlăturați-le imediat folosind un lac corespunzător.

Nu utilizați agenți de curățare agresivi, perii cu fire metalice sau de nailon, nici ustensile ascuțite sau metalice, cum ar fi lame ori spatule. Pentru curățare, folosiți perii moi. Folosiți apă rece, curată.



## UNELTE ȘI ECHIPAMENT

Îmbrăcăminte de protecție (mănuși, încălțăminte, ochelari, cască etc.)

Nivelă

Tijă pentru măsurarea lungimii

Scară (cca. 1,5 m înălțime)

Seturi de chei

Șurubelniță electrică și bormașină cu diferite atașamente

Șurubelniță

(nu sunt incluse în pachet)

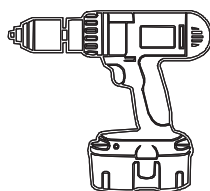
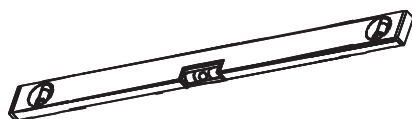

## ELIMINAREA AMBALAJULUI

Eliminați corespunzător ambalajul.

Cartonul și hârtia se elimină ca hârtie veche, iar pentru folii puteți apela la centrele de reciclare.

## ELIMINAREA MAGAZIEI



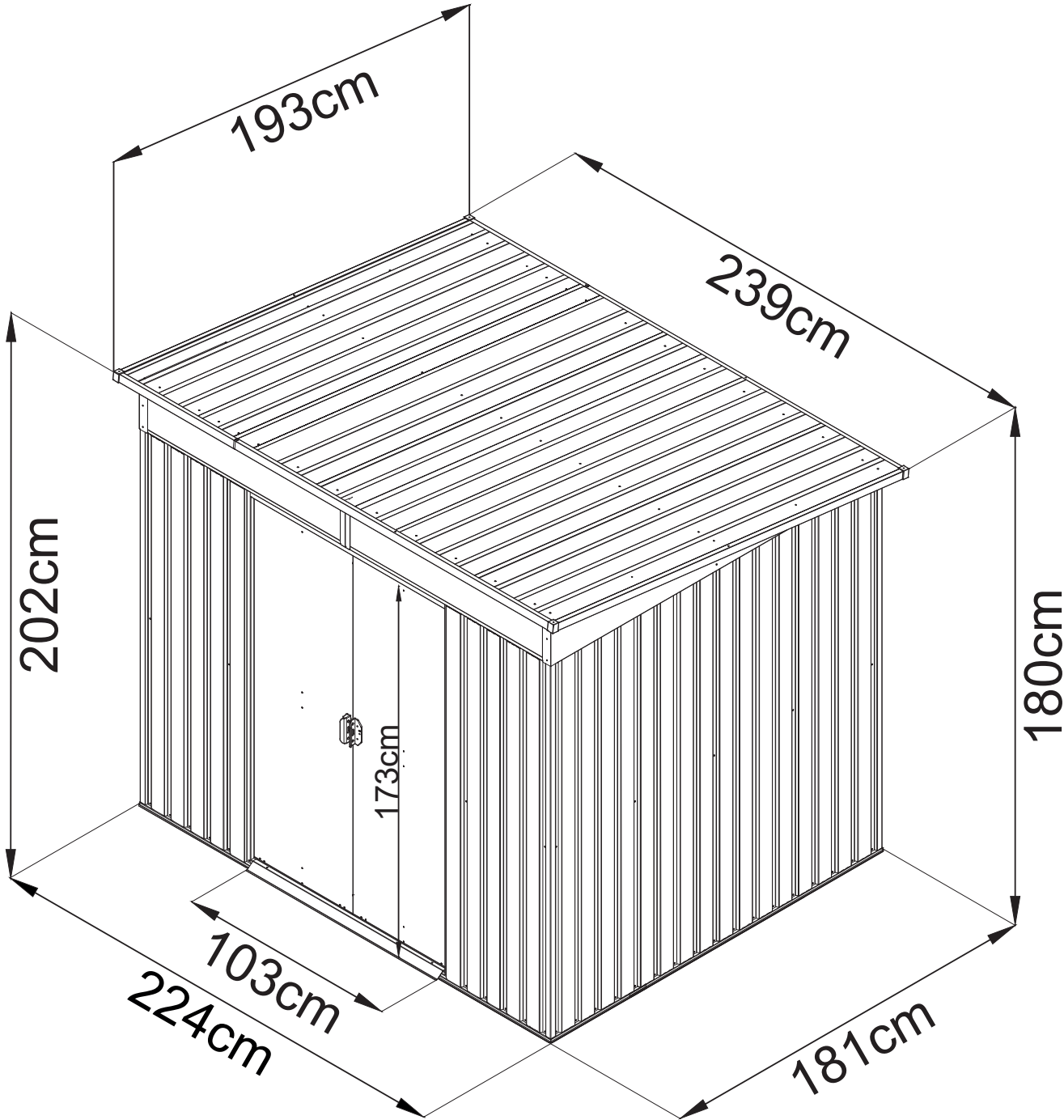

La eliminarea magaziei, vă rugăm să respectați directivele, legile și reglementările aplicabile în țara sau în regiunea dumneavoastră.





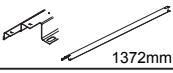
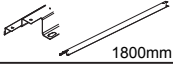
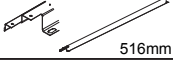
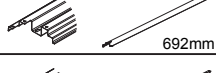
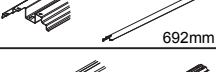
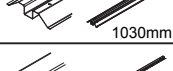
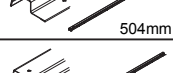
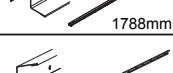
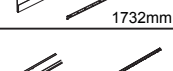
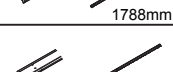
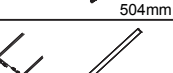
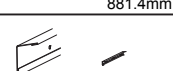

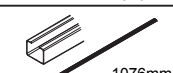
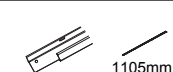
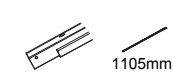
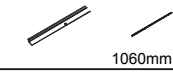
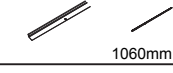
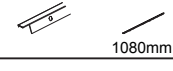
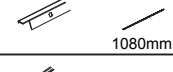
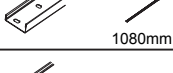

**DIMENSIUNI**

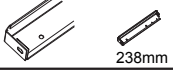
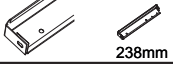
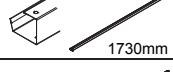
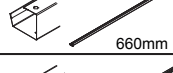
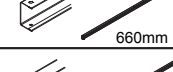
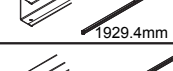
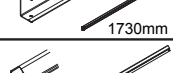
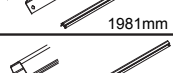
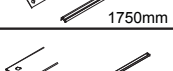
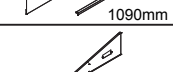



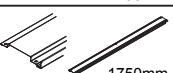
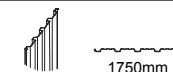

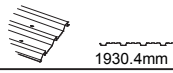
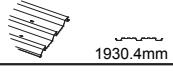
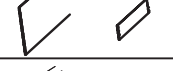
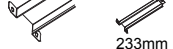





**RO**



# LISTĂ DE PIESE

NR.	PIESĂ	CANTITATE
1	 1372mm	2
2	 1800mm	1
1-1	 516mm	3
3L	 692mm	1
3R	 692mm	1
5	 1030mm	1
9-1	 504mm	1
9	 1788mm	1
20	 1732mm	2
11	 1788mm	1
11-1	 504mm	1
11-2	 881.4mm	1
B1	 128mm	2
7L	 1076mm	1
7R	 1076mm	1
12L	 1105mm	1
12R	 1105mm	1
14L	 1060mm	1
14R	 1060mm	1
15L	 1080mm	1
15R	 1080mm	1
16L	 1080mm	1
16R	 1080mm	1

NR.	PIESĂ	CANTITATE
19L	 238mm	1
19R	 238mm	1
10	 1730mm	1
10-1	 660mm	1
17-1	 660mm	1
17-2	 1929.4mm	2
17	 1730mm	1
13	 1981mm	2
13-1	 1750mm	2
6	 1090mm	1
21L		1
21R		1
18	 566mm	6
4L	 1750mm	1
4R	 1750mm	1
P1	 1750mm	15
P2	 1930.4mm	2
P3	 1930.4mm	3
P4	 1930.4mm	1
P5		2
22	 233mm	2

## LISTĂ DE PIESE

NR.	PIESĂ	CANTITATE
G2		4
GD		4
GB		2
GC		4
GS		2
F1		310
F2		58
F3		8
S2		167
S3		252

NR.	PIESĂ	CANTITATE
D1	 1740X570mm	1
D2	 1740X570mm	1

RO

# PRIVIRE DE ANSAMBLU MONTAJ

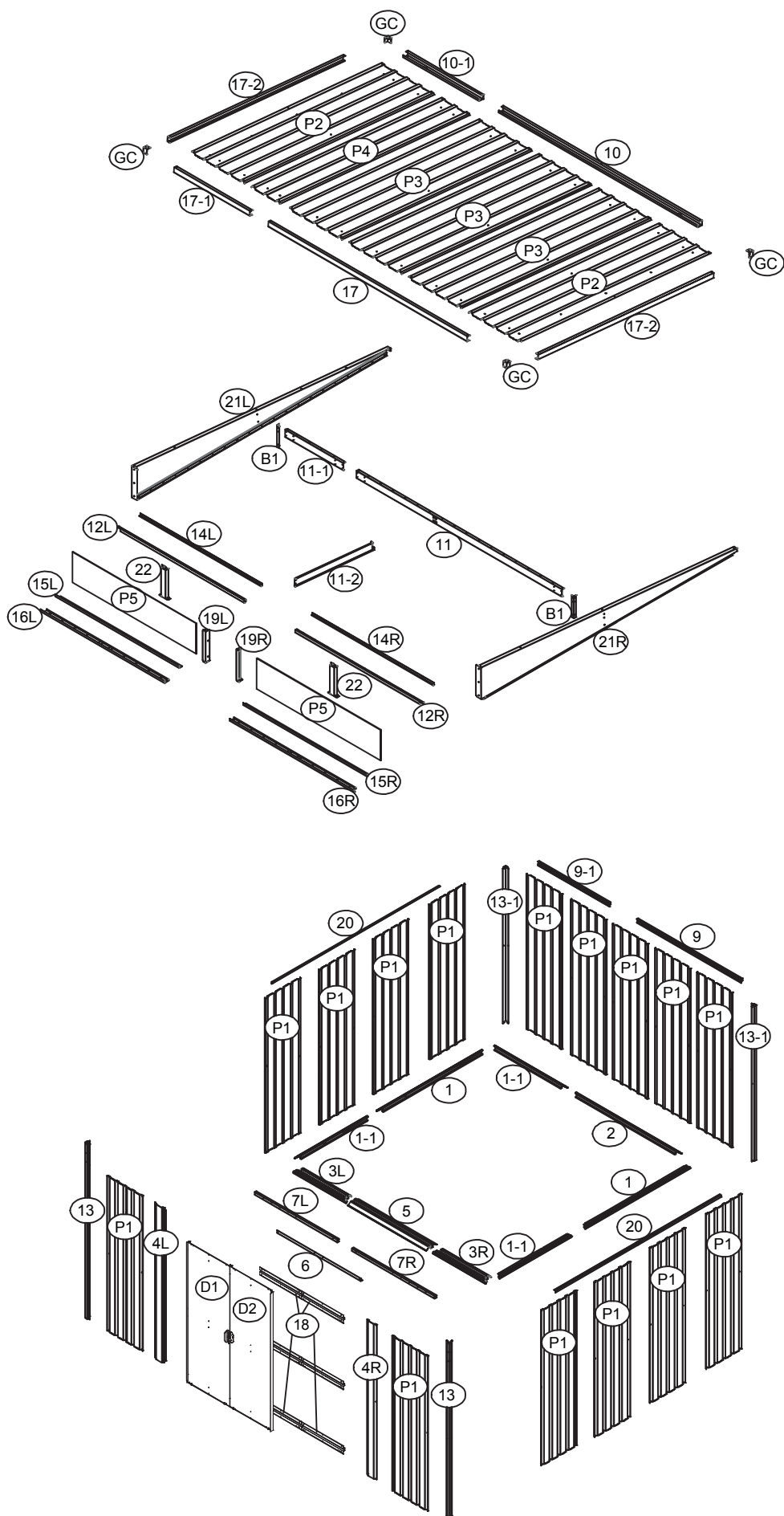

## VRTNA LOPA LIGHTLINE Z ENOKAPNO STREHO NAVODILA ZA SESTAVLJANJE

Mere: D × Š × V: 239 x 193 x 202 cm

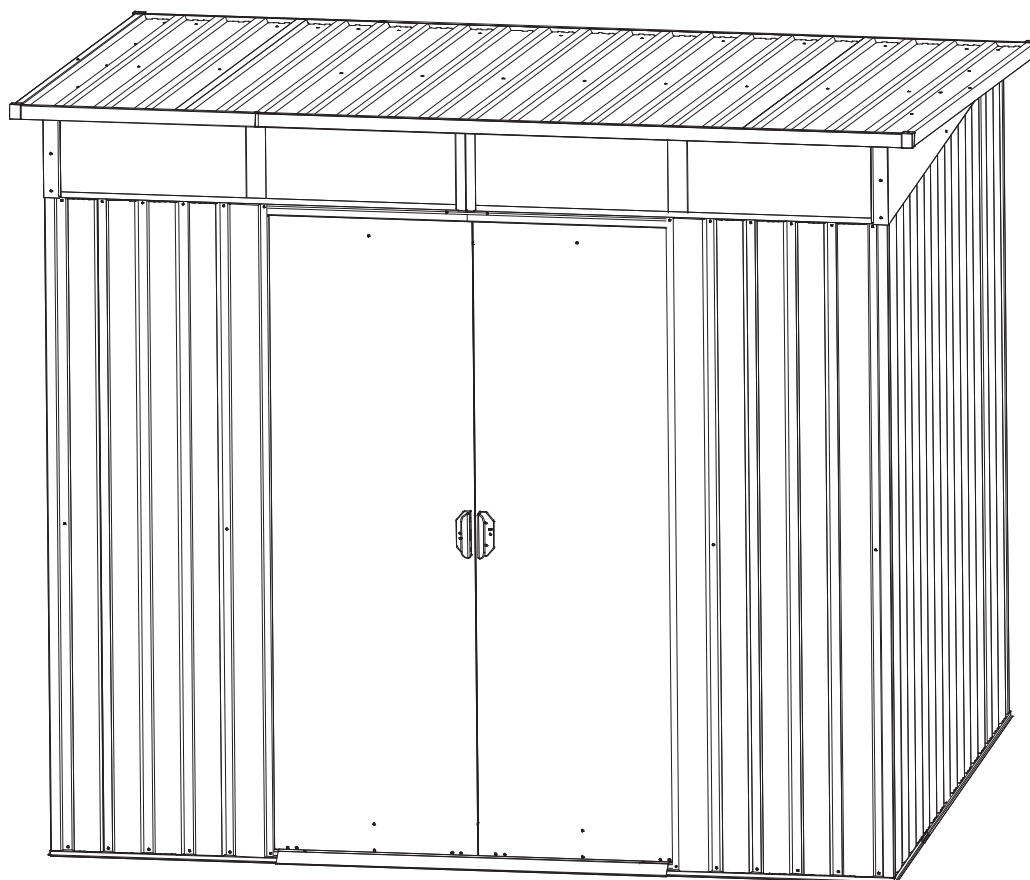

SL

### NAPOTEK:

Skrbno preberite navodila za sestavljanje, preden začnete s sestavljanjem vrtno lopa.

To še zlasti velja za varnostne napotke.

V nasprotnem primeru lahko poškodujete sebe ali vrtno lopa.

Vrtna lopa ni plezalno ogrodje za otroke in ogrodje za rast rastlin. Obstaja nevarnost preobremenitve.

Prepričajte se, da so vsi potrebni sestavni deli na voljo v navedenih količinah.

Posamezne korake sestavljanja izvajajte zaporedoma in v navedenem vrstnem redu, kot je navedeno v teh navodilih.

Nobenega od navedenih korakov ne izpustite ali ga skrajšajte.

Navodila za sestavljanje hranite na varnem mestu, da lahko do njih znova dostopate v prihodnosti.

## SPLOŠNE INFORMACIJE:

Preden začnete z montažo, se prepričajte, da so upoštewane zadevne smernice/zakoni. Za montažo načrtujte vsaj od 390 do 450 minut.

Za montažo so potrebne vsaj 2 osebe. Pred začetkom dela se prepričajte, da so prisotni vsi deli, in sicer v pravih količinah. Za sestavljanje uporabite sončno površino na prostem, nad katero ni vej.

Pred začetkom montaže preglejte posamezne sestavne dele glede nepoškodovanosti in jih odložite tako, da je med delom do sestavnih delov mogoče dostopati brez težav.

Najbolje je, če majhne dele, kot so vijaki, matice itd., hranite v posodi, tako da jih ne izgubite.

Vrtno lopa nikakor ne uporabljajte kot oporo za stročnice, plezalke in ovijalke, sadje, zelenjavo ali kot držalo za vrv za perilo.

Poskrbite, da na vrtni lopa ni snega in listja. **Najv. nosilnost je 90 kg/m<sup>2</sup>.**

Vrtno lopa uporabljajte izključno tako, kot je opisano v teh navodilih za montažo.

Proizvajalec ali trgovec ne prevzema nobene odgovornosti za škodo, ki nastane zaradi nenamenske ali nepravilne uporabe. Vrtno lopa ne postavljajte neposredno na trato ali neravne podlage ter poskrbite za primerno, vzdržljivo, vodoravno in stabilno podlago. Priporočamo, da vrtno lopa zasidrate trdno v tla. Prepričajte se, da so vsi vijaki trdno priviti in da je ogrodje pravilno usmerjeno in vodoravno. Redno preverjajte, ali so vsi vijaki trdno priviti in jih po potrebi dodatno zategnite.

**Nekateri kovinski deli so opremljeni z zaščitno folijo. To folijo je treba pred začetkom vgradnje previdno odstraniti.**

## VARNOSTNI NAPOTKI:

Nikoli ga ne postavljajte neposredno na strešno površino, obstaja nevarnost preobremenitve. Tudi ne v času montaže ali za čiščenje.

Obstaja nevarnost za otroke in osebe z zmanjšanimi fizičnimi, zaznavnimi ali duševnimi sposobnostmi (npr. osebe, ki so pretrujene, delno invalidne osebe, starejše osebe z zmanjšanimi fizičnimi in duševnimi sposobnostmi) ali pomanjkanjem znanja in izkušenj (npr. starejši otroci). Pri montaži vrtno lopa se uporabljajo majhni deli, kot so vijaki in matice, na podlagi česar obstaja nevarnost zadušitve, če se jih zaužije.

Vrtno lopa sme sestavljati le strokovnjak, v postopek pa ne smejo biti vključeni otroci ali osebe z zmanjšanimi duševnimi ali motoričnimi sposobnostmi ali osebe s pomanjkanjem izkušenj.

Zaradi nepravilnega ravnanja z vrtno lopa lahko pride do telesnih poškodb ali materialne škode.

Pri jemanju posameznih sestavnih delov iz embalaže bodite previdni. **Obstaja nevarnost telesnih poškodb zaradi ostrih robov.** Posamezni sestavni deli so izdelani iz kovine in so zaradi tega težki. Pri neprevidnem odpiranju embalaže, npr. z ostrim nožem ali drugim ostrim/koničastim predmetom, obstaja nevarnost poškodb sestavnih delov. Po jemanju sestavnih delov iz embalaže preverite, ali so vsi sestavni deli na voljo v pravih količinah. Posamezne dele odložite na odejo ali podobno podlago, da preprečite raze na premazu.

Preverite, ali so posamezni sestavni deli v brezhibnem stanju, oz. preverite, ali so na njih poškodbe, v primeru česar poškodovanih, deformiranih delov ne uporabljajte.

Med sestavljanjem in montažo nosite vedno varnostna oblačila. Med osnovno opremo sodijo zaščitna obutev, zaščitne rokavice, zaščitna očala in čelada.

Vrtno lopa ne montirajte ob dnevih, ko piha močan veter ali pada dež.

Poskrbite, da se sestavni deli ne dotikajo nobenih električnih kablov.

Embalažo, plastične vrečke ali zaščitne folije pravilno zavržite in jih hranite zunaj dosega otrok, saj obstaja nevarnost zadušitve.

Vrtno lopa postavite na ravno površino.

Prepričajte se, da med montažo na območju nevarnosti ni otrok.

Vrtno lopa ne postavljajte na območjih, ki so izpostavljena močnim ali stalnim vetrovom.

Zaradi osebne varnosti ne sestavljajte vrtno lopa, če ste utrujeni, pod vplivom alkohola ali mamil oz. če imate vrtoglavico ali se ne počutite dobro.

Če uporabljate lestve ali elektronske naprave, se prepričajte, da upoštevate navedbe posameznih proizvajalcev glede uporabe. Vročih naprav, kot so žari, grelne naprave, gorilniki itd., ni dovoljeno uporabljati v vrtni lopa ali jih v njej skladiščiti, saj obstaja nevarnost požara. V primeru neurja ali viharja se nikoli ne zadržujte v vrtni lopa ali ob njej. Obstaja nevarnost udara strele.

## NEGA IN VZDRŽEVANJE:

Površine redno čistite. Če na površinah opazite raze, jih takoj odstranite s primernim lakom.

Ne uporabljajte nobenih agresivnih čistilnih sredstev, krtač s kovinskimi ali najlonskimi ščetinami ter ostrih ali kovinskih predmetov, kot so noži ali lopatice. Za čiščenje uporabljajte krtače z mehкими ščetinami. Uporabljajte hladno, čisto vodo.

## ORODJA IN OPREMA:

Varnostna oblačila (zaščitna obutev, zaščitne rokavice, zaščitna očala, čelada itd.)

Vodna tehtnica

Merilnik dolžine

Lestev (visoka pribl. 1,5 m)

Vijačni ključ ali raglja

Akumulatorski izvijač in vrtalnik z razl. nastavki

Izvijač

(ni priloženo kompletu)



SL

## ODLAGANJE EMBALAŽE MED ODPADKE:

Embalažo odložite med odpadke ločeno po vrstah materialov.

Lepenke in karton zavrzite kot odpadni papir, folije

pa oddajte na ustreznem zbirnem mestu.

## ODLAGANJE VRTNE LOPA ODPADKE:

Pri odlaganju vrtno lopa med odpadke upoštevajte veljavne smernice, zakone in druge določbe v zvezi z odlaganjem opreme med odpadke v svoji državi ali zvezni državi.





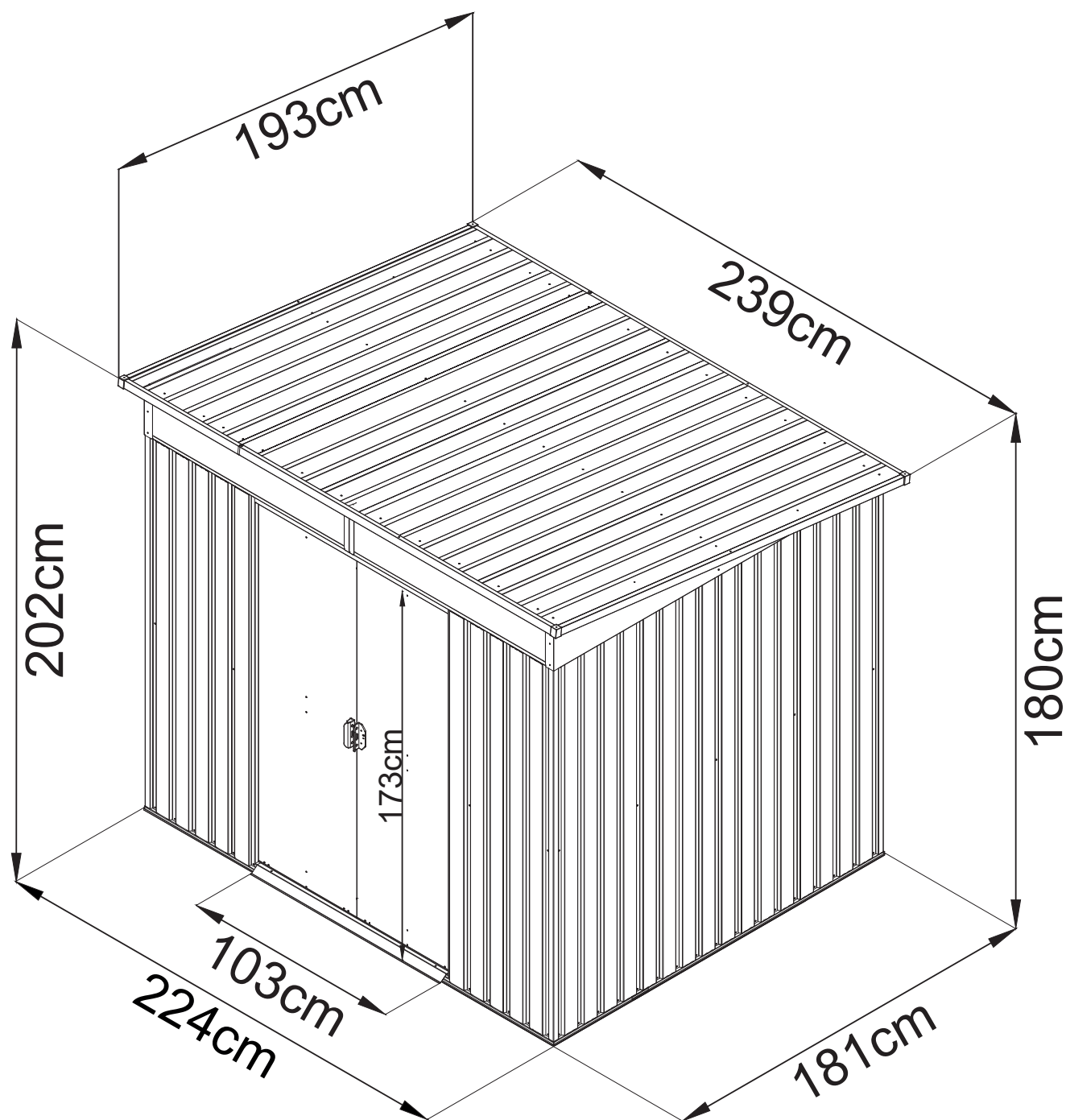





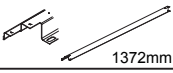
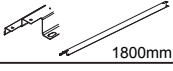
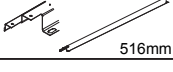
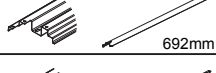
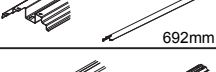
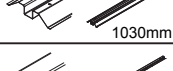
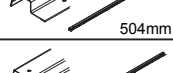
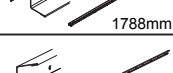
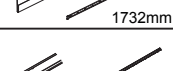
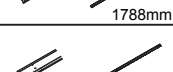
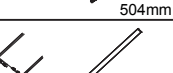
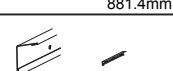

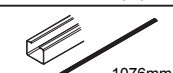
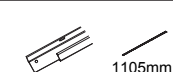
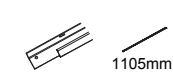
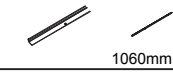
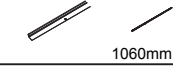
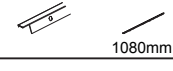
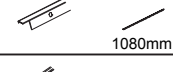
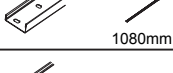
# DIMENZIJE



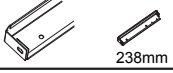
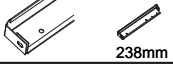
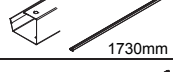
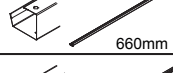
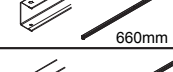
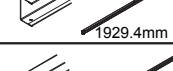
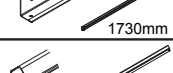
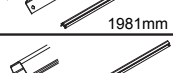
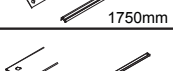
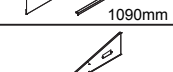
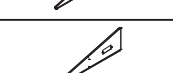

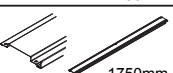
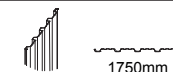

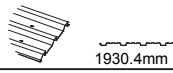
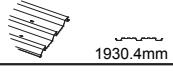
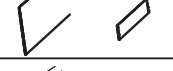
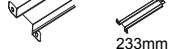





SL



# SEZNAM DELOV

ŠT.	DEL	KOLIČINA
1	 1372mm	2
2	 1800mm	1
1-1	 516mm	3
3L	 692mm	1
3R	 692mm	1
5	 1030mm	1
9-1	 504mm	1
9	 1788mm	1
20	 1732mm	2
11	 1788mm	1
11-1	 504mm	1
11-2	 881.4mm	1
B1	 128mm	2
7L	 1076mm	1
7R	 1076mm	1
12L	 1105mm	1
12R	 1105mm	1
14L	 1060mm	1
14R	 1060mm	1
15L	 1080mm	1
15R	 1080mm	1
16L	 1080mm	1
16R	 1080mm	1

ŠT.	DEL	KOLIČINA
19L	 238mm	1
19R	 238mm	1
10	 1730mm	1
10-1	 660mm	1
17-1	 660mm	1
17-2	 1929.4mm	2
17	 1730mm	1
13	 1981mm	2
13-1	 1750mm	2
6	 1090mm	1
21L		1
21R		1
18	 566mm	6
4L	 1750mm	1
4R	 1750mm	1
P1	 1750mm	15
P2	 1930.4mm	2
P3	 1930.4mm	3
P4	 1930.4mm	1
P5		2
22	 233mm	2

## SEZNAM DELOV

ŠT.	DEL	KOLIČINA
G2		4
GD		4
GB		2
GC		4
GS		2
F1		310
F2		58
F3		8
S2		167
S3		252

ŠT.	DEL	KOLIČINA
D1	 1740X570mm	1
D2	 1740X570mm	1

SL

# PREGLED ZA MONTAŽO

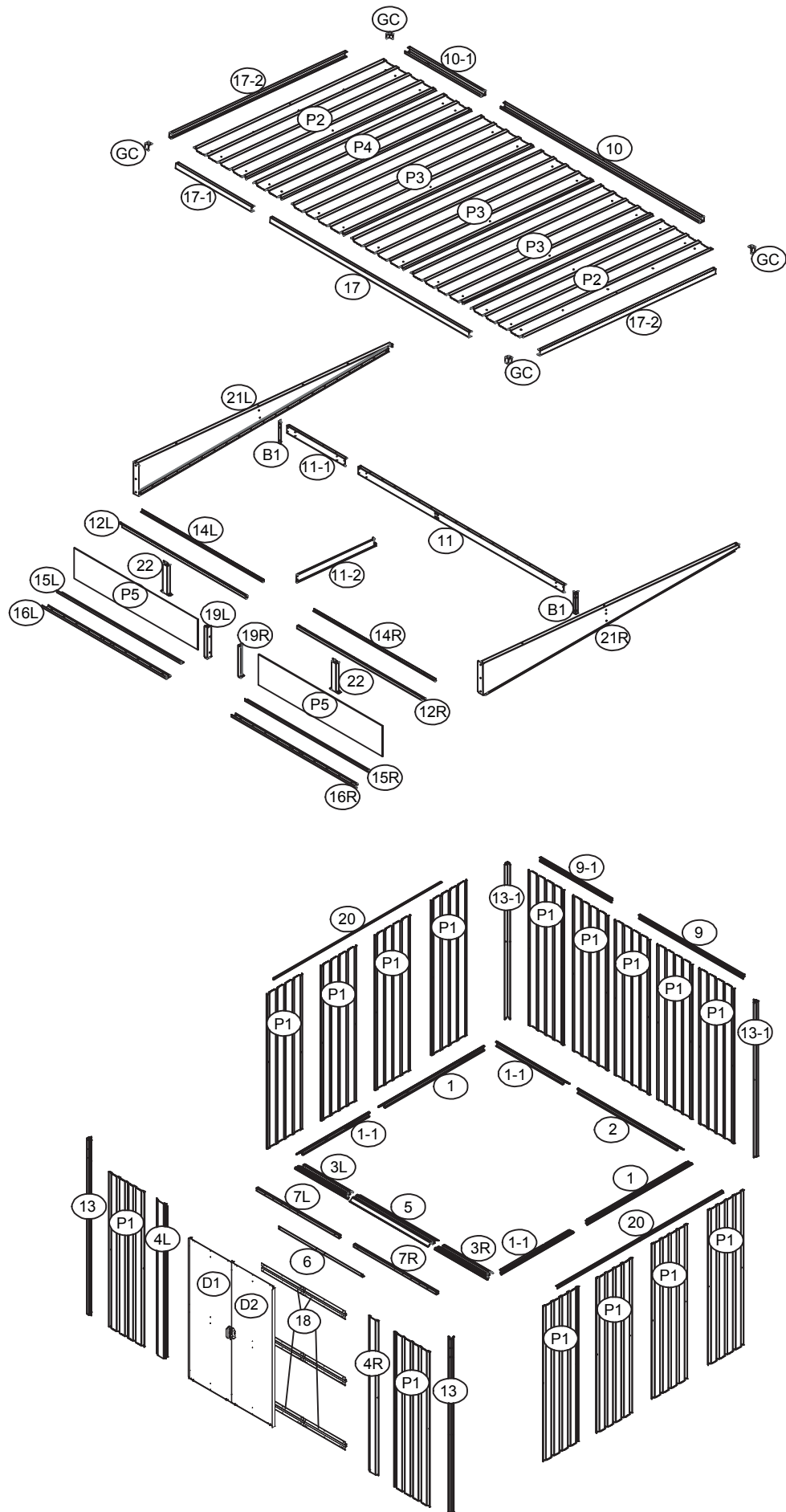

SL

## DOMEK NA NÁŘADÍ LIGHTLINE S PULTOVOU STŘECHOU NÁVOD PRO MONTÁŽ

Rozměry: D x Š x V 239 x 193 x 202 cm

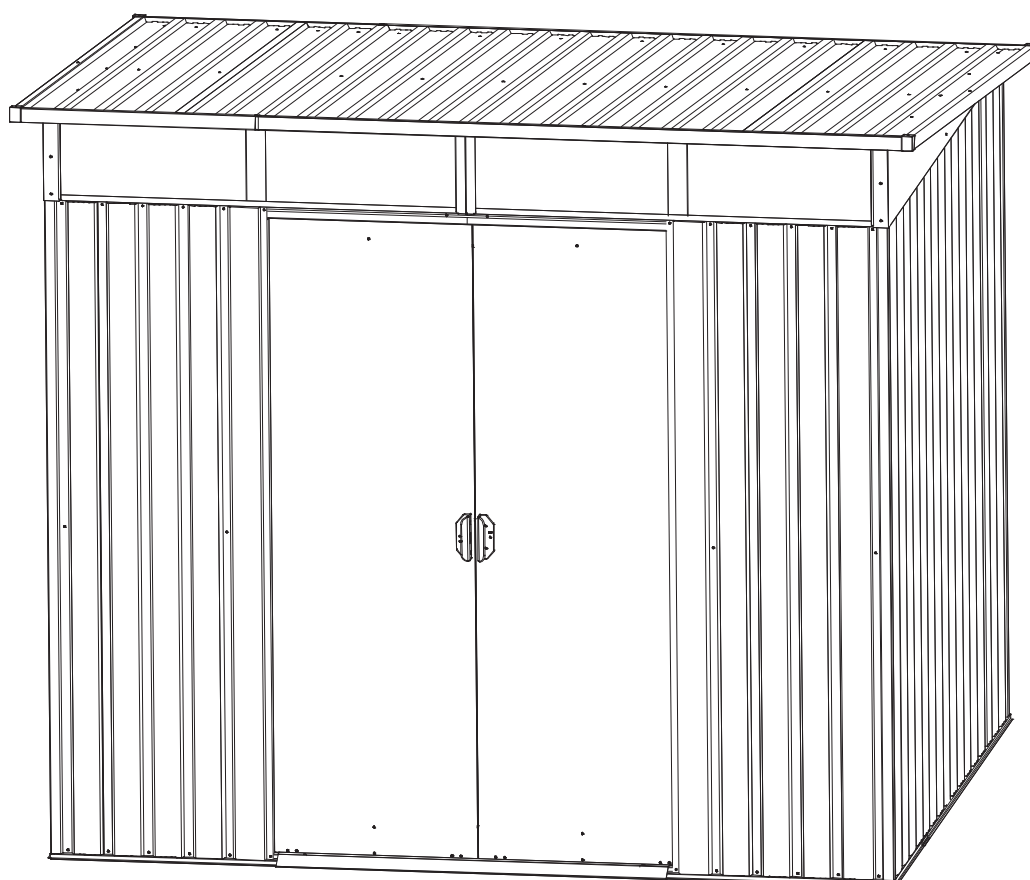

CZ

### UPOZORNĚNÍ:

Před zahájením montáže přístřešku si pečlivě přečtete montážní pokyny.

To se týká především bezpečnostních pokynů.

V opačném případě byste se mohli zranit nebo poškodit přístřešek.

Přístřešek není lezeckým rámem pro děti a není lezeckou pomůckou. Hrozí nebezpečí přetížení.

Ujistěte se, že všechny požadované komponenty jsou k dispozici v určeném množství.

Jednotlivé montážní kroky provádějte jeden po druhém a v pořadí uvedeném v tomto návodu.

Nevynechte žádný z uvedených kroků ani je nezkracujte.

Návod pro montáž uschovejte na bezpečném místě, abyste jej v budoucnu mohli využít.

## VŠEOBECNÉ INFORMACE:

Před zahájením montáže se ujistěte, že jsou dodržovány pro vás platné směrnice/zákony. Pro montáž si naplánujte minimálně 390 až 450 minut.

Pro montáž je zapotřebí minimálně 2 osob. Před zahájením práce zkontrolujte, zda jsou všechny díly k dispozici ve správném množství. K montáži zvolte volnou, slunnou plochu bez přečnávajících větví.

Před zahájením montáže zkontrolujte, zda jsou jednotlivé konstrukční díly neporušené, a položte je tak, aby byly během práce snadno dostupné.

Nejllepší je uchovávat malé části, jako jsou šrouby, matice atd., v misce tak, aby nedošlo k jejich ztrátě.

Přístřešek v žádném případě nepoužívejte jako pomůcku pro popínání luštěnin, popínavých rostlin, ovoce, zeleniny nebo jako držák na prádelní šňůru.

Z přístřešku odstraňujte sníh a spadané listí. **Max. nosnost 90 kg/m<sup>2</sup>.**

Přístřešek používejte pouze tak, jak je to popsáno v tomto montážním návodu.

A gyártó vagy a kereskedő nem vállal felelősséget olyan károktól, amelyek a rendeltetésellenes vagy hibás használat miatt következnek be. Ne állítsa a kerti fészert közvetlenül a tűre vagy egyenetlen talajra, gondoskodjon a megfelelő teherbíró képességgel rendelkező vízszintes és stabil aljzatról. Javasoljuk, hogy rögzítse a kerti fészert szilárdan a talajhoz. Győződjön meg arról, hogy minden csavart szilárdan meghúzott és helyes irányban és vízszintesen áll a keret. Ellenőrizze rendszeresen, hogy szilárdan meghúzott minden csavart és szükség esetén húzza után azokat.

**Některé kovové díly jsou opatřeny ochrannou fólií. Tuto fólii je nutno před zahájením montáže opatrně odstranit.**

## BEZPEČNOSTNÍ POKYNY:

Nikdy nestoupejte přímo na plochu střechy, hrozí nebezpečí přetížení. To platí i během montáže a čištění.

Hrozí nebezpečí pro děti a osoby s omezenými fyzickými, smyslovými nebo mentálními schopnostmi (např. unavení lidé, částečně zdravotně postižení lidé, starší lidé se sníženou fyzickou a duševní schopností) nebo nedostatkem zkušeností a znalostí (např. starší děti). Při montáži přístřešku se používají malé části, jako jsou šrouby a matice, které při spolknutí představují nebezpečí udušení.

Zahradní přístřešek mohou postavit pouze kvalifikované osoby, nikoli děti nebo osoby s omezenými intelektuálními nebo motorickými dovednostmi nebo nedostatkem zkušeností.

Nesprávné zacházení s přístřeškem může způsobit zranění nebo materiální škody.

Při vybalování jednotlivých konstrukčních dílů z obalu buďte opatrní. **Hrozí nebezpečí poranění o ostré hrany.**

Jednotlivé komponenty jsou vyrobeny z kovu a jsou proto těžké. Pokud je obal otevřen neopatrně, například ostrým nožem nebo jiným ostrým/špičatým předmětem, může dojít k poškození jednotlivých součástí. Po vybalení součástí zkontrolujte, zda jsou všechny jednotlivé díly k dispozici ve správném množství. Jednotlivé díly položte na deku a podobně, abyste zabránili poškrábání horních vrstev.

Zkontrolujte, zda jsou jednotlivé konstrukční díly v perfektním stavu nebo zda nevykazují známky poškození, v takovém případě poškozené a deformované součásti nepoužívejte.

Během výstavby a montáže vždy noste ochranný oděv. K základnímu vybavení patří bezpečnostní obuv, ochranné rukavice, ochranné brýle a helma.

Výstavbu přístřešku neprovádějte ve velmi větrných nebo deštivých dnech.

Ujistěte se, že se komponenty nedotýkají žádných napájecích kabelů.

Obaly, plastové sáčky nebo ochranné fólie řádně zlikvidujte a uchovávejte je mimo dosah dětí, nebezpečí udušení!

Přístřešek postavte na rovnou plochu.

Během montáže se ujistěte, že se v nebezpečné oblasti nenacházejí žádné děti.

Přístřešek neumísťujte na místa vystavená silnému nebo trvalému větru.

Pro vaši osobní bezpečnost byste přístřešek neměli stavět, pokud jste unavení, opilí nebo intoxikovaní, nebo máte-li závratě nebo není-li vám dobře.

Používáte-li žebříky nebo elektronická zařízení, ujistěte se, že dodržíte pokyny výrobce k jejich používání. Horká zařízení, jako jsou grily, ohříváče, hořáky atd., nesmíte pod přístřeškem používat ani skladovat, nebezpečí požáru!

Během bouřky se nikdy nezdržujte v přístřešku nebo v jeho blízkosti. Hrozí nebezpečí úderu blesku.

## PÉČE A ÚDRŽBA:

Povrch pravidelně čistěte. Pokud si všimnete škrábanců na povrchu, okamžitě je odstraňte pomocí vhodného laku.

Nepoužívejte agresivní čisticí prostředky, kovové nebo nylonové kartáče ani ostré nebo kovové pomůcky, jako jsou nože nebo špachtle. K čištění používejte měkké štětiny. Použijte studenou, čistou vodu.

## NÁŘADÍ A VYBAVENÍ:

Ochranné oděvy (bezpečnostní obuv, ochranné rukavice, ochranné brýle, helma atd.)

Vodováha

Měření délky

Štafle (přibližně 1,5 m vysoké)

Šroubový nebo řehtačkový klíč

Akumulátorový šroubovák a vrtačka s růz. nástavci

Šroubovák

(Není součástí dodávky)

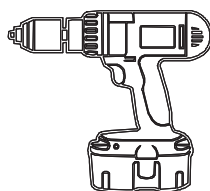
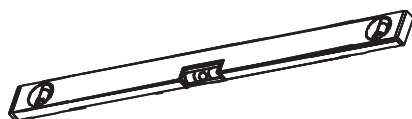

CZ

## LIKVIDACE OBALU:

Obaly zlikvidujte do tříděného dopadu.

Karton a lepenka se likvidují jako odpadní papír a fólie odevzdejte k vhodné recyklaci.

## LIKVIDACE PŘÍSTŘEŠKU:

Při likvidaci zahradního přístřešku věnujte pozornost pokynům, zákonům a předpisům týkajícím se likvidace ve vaší zemi nebo státě.



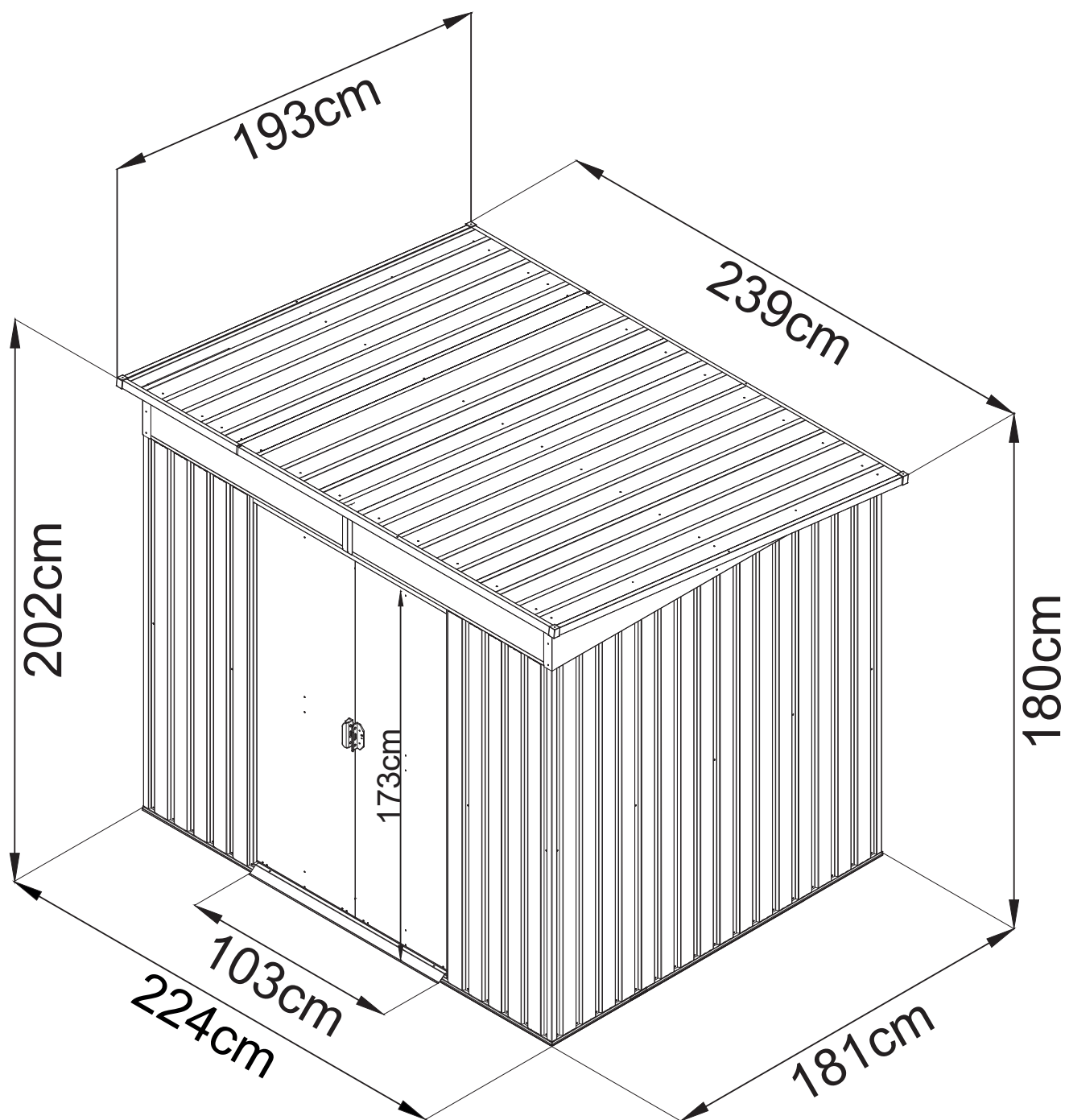

# ROZMĚRY





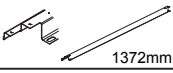
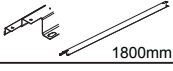
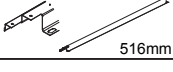
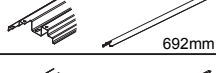
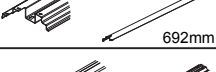
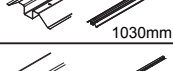
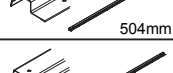
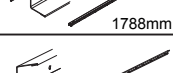
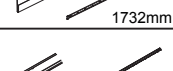
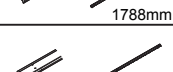
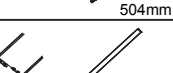
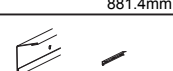

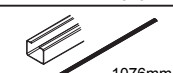
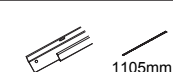
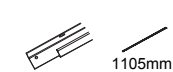
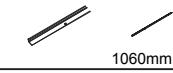
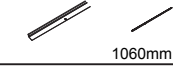
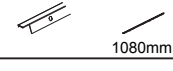
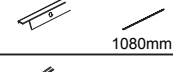
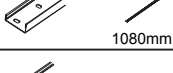

CZ

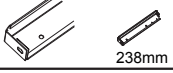
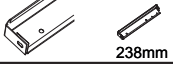
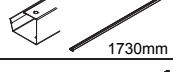
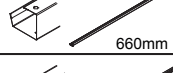
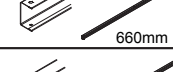
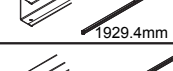
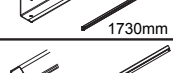
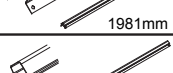
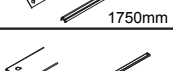
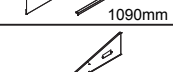
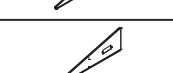

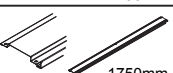
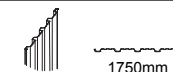

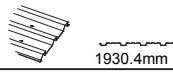
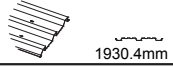
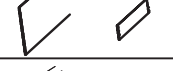
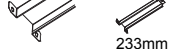









# SEZNAM DÍLŮ

č.	SOUČÁST	MNOŽSTVÍ
1	 1372mm	2
2	 1800mm	1
1-1	 516mm	3
3L	 692mm	1
3R	 692mm	1
5	 1030mm	1
9-1	 504mm	1
9	 1788mm	1
20	 1732mm	2
11	 1788mm	1
11-1	 504mm	1
11-2	 881.4mm	1
B1	 128mm	2
7L	 1076mm	1
7R	 1076mm	1
12L	 1105mm	1
12R	 1105mm	1
14L	 1060mm	1
14R	 1060mm	1
15L	 1080mm	1
15R	 1080mm	1
16L	 1080mm	1
16R	 1080mm	1

č.	SOUČÁST	MNOŽSTVÍ
19L	 238mm	1
19R	 238mm	1
10	 1730mm	1
10-1	 660mm	1
17-1	 660mm	1
17-2	 1929.4mm	2
17	 1730mm	1
13	 1981mm	2
13-1	 1750mm	2
6	 1090mm	1
21L		1
21R		1
18	 566mm	6
4L	 1750mm	1
4R	 1750mm	1
P1	 1750mm	15
P2	 1930.4mm	2
P3	 1930.4mm	3
P4	 1930.4mm	1
P5		2
22	 233mm	2

## SEZNAM DÍLŮ

č.	SOUČÁST	MNOŽSTVÍ
G2		4
GD		4
GB		2
GC		4
GS		2
F1		310
F2		58
F3		8
S2		167
S3		252

č.	SOUČÁST	MNOŽSTVÍ
D1	 1740X570mm	1
D2	 1740X570mm	1

# MONTÁŽNÍ PŘEHLED

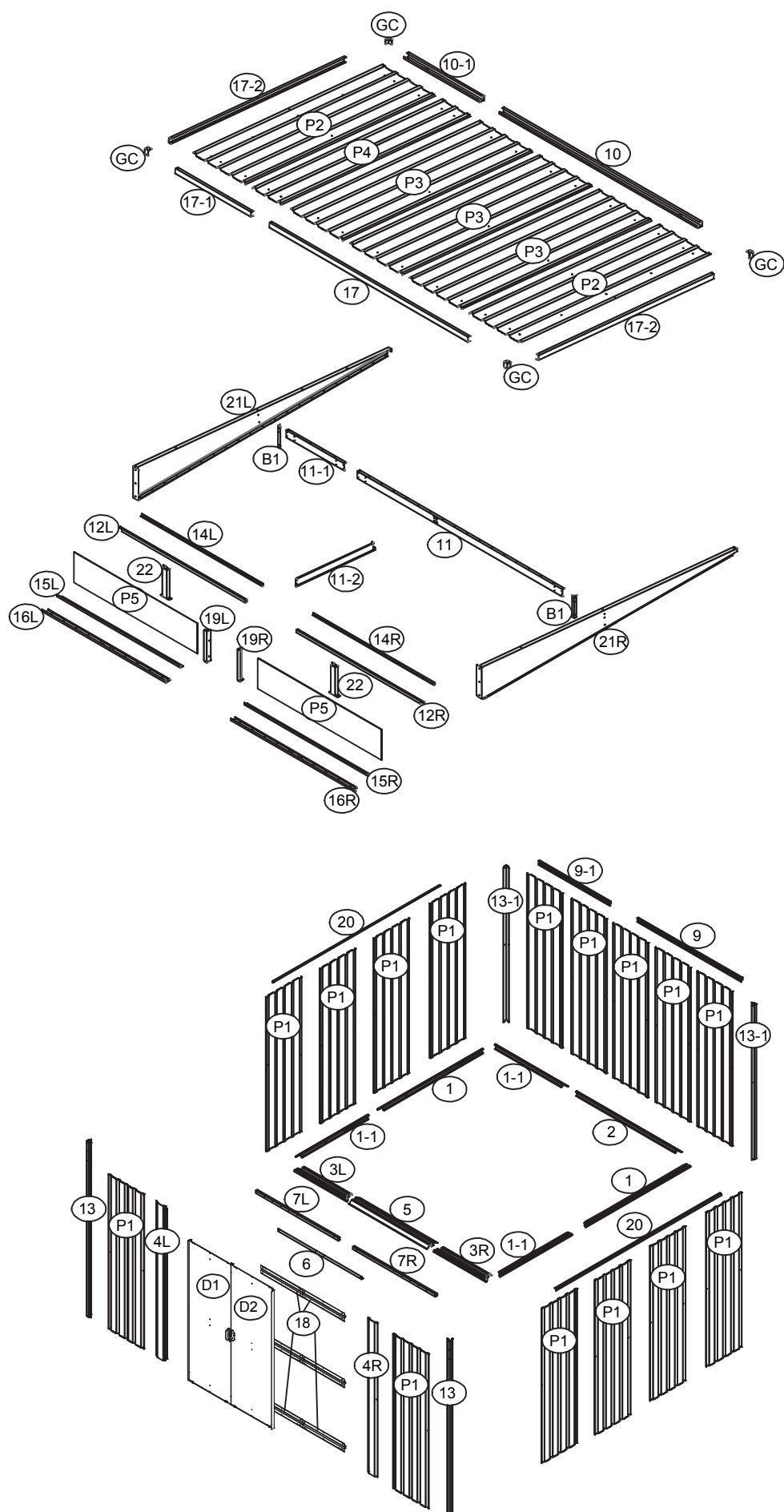

## ZÁHRADNÝ DOMČEK LIGHTLINE SO PULTOVOU STRECHOU NÁVOD NA MONTÁŽ

Rozmery: D x Š x V 239 x 193 x 202 cm

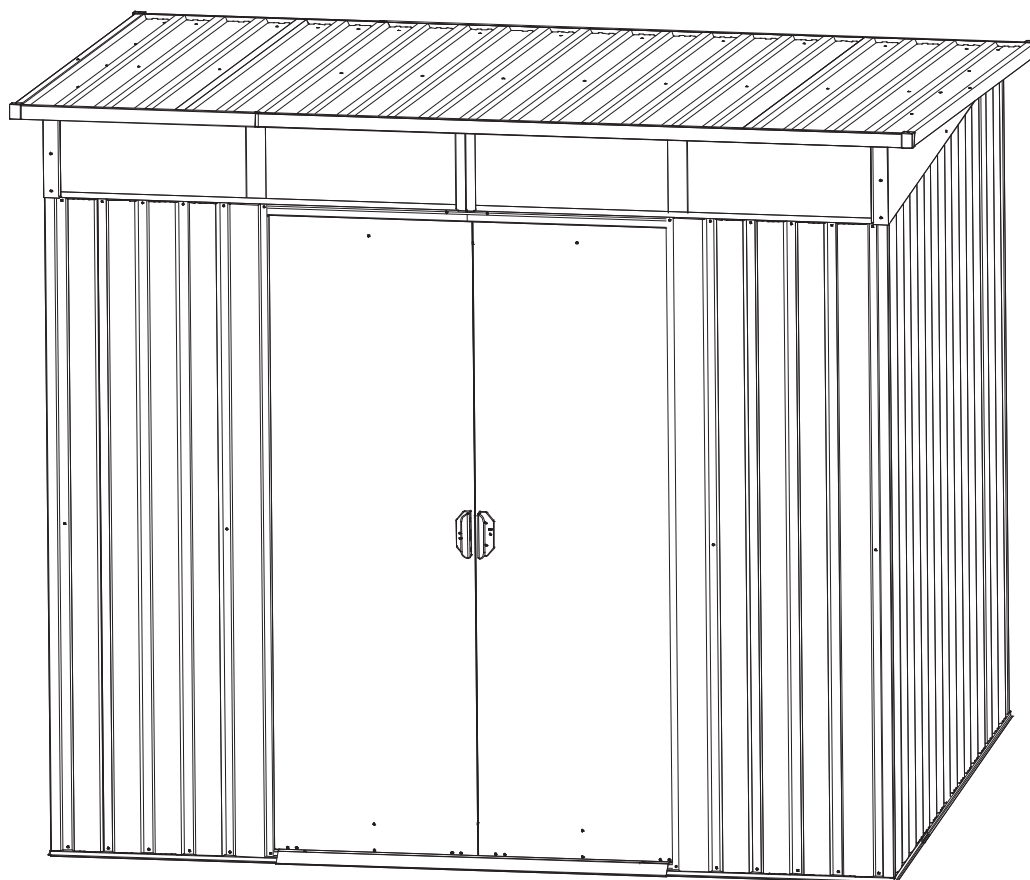

SK

### UPOZORNENIE:

Pred začatím montáže si pozorne prečítajte návod na montáž.

Dbajte o bezpečnosť a venujte pozornosť najmä bezpečnostným pokynom.

V opačnom prípade by ste sa mohli poraniť alebo poškodiť záhradný domček.

Záhradný domček nie je preliezka pre deti ani pomôcka na lezenie. Pozor na riziko preťaženia.

Uistite sa, že všetky požadované diely máte k dispozícii v špecifikovanom množstve.

Jednotlivé kroky montáže vykonávajte jeden po druhom a v špecifikovanom poradí, ako je uvedené v tomto návode.

Nevynechávajte ani neskracujte žiadny z uvedených krokov.

Návod na montáž uschovajte na bezpečnom mieste, aby ste k nemu mali prístup aj neskôr.

## VŠEOBECNÉ INFORMÁCIE:

Pred začatím montáže sa uistite, že sú dodržané príslušné smernice/zákony. Na montáž si vyhradte najmenej 390 až 450 minút.

K montáži sú potrebné najmenej 2 osoby. Pred začatím práce skontrolujte, či máte všetky diely v správnom množstve. Na postavenie záhradného domčeka použite slnečnú plochu bez vyčnievajúcich vetiev.

Pred začatím montáže skontrolujte, či sú jednotlivé diely nedotknuté a položte ich tak, aby boli počas práce ľahko prístupné.

Najlepšie je uchovávať malé časti, ako sú skrutky, matice atď. v miske, aby sa nestratili.

Za žiadnych okolností nepoužívajte domček ako opornú konštrukciu na pestovanie strukovín a popínavých rastlín, ovocia, zeleniny alebo ako držiak na šnúru na bielizeň.

Udržujte záhradný domček bez snehu a lístia. **Maximálne zaťaženie 90 kg/m<sup>2</sup>.**

Záhradný domček používajte výhradne na účely, ktoré sú uvedené v tomto návode na montáž.

Výrobca alebo predajca nenesie žiadnu zodpovednosť za škody spôsobené nevhodným alebo nesprávnym použitím.

Nestavajte záhradný domček priamo na trávniku alebo nerovnom povrchu, na jeho lokáciu vyhradte a zabezpečte vhodný, odolný, vodorovný a stabilný povrch. Odporúčame upevniť záhradný domček pevne k podlahe. Skontrolujte, či sú všetky skrutky dotiahnuté a či je rám správne vyrovnaný a vo vodorovnej polohe. Pravidelne kontrolujte dotiahnutie všetkých skrutiek a v prípade potreby ich dotiahnite. **Niektoré kovové časti sú pokryté ochrannou fóliou.**

**Táto fólia musí byť pred zahájením montáže opatrne odstránená.**

## BEZPEČNOSTNÉ POKYNY:

Nikdy sa nestavajte priamo na plochu strechy, hrozí nebezpečenstvo preťaženia. Ani počas montáže alebo pri čistení.

Záhradný domček predstavuje riziko pre deti a ľudí s obmedzenými fyzickými, zmyslovými alebo mentálnymi schopnosťami (napr. unavení ľudia, čiastočne postihnutí ľudia, starší ľudia so zníženými fyzickými a duševnými schopnosťami) alebo nedostatkom skúseností a znalostí (napr. staršie deti). Pri montáži záhradného domčeka sa používajú malé časti, ako sú skrutky a matice, ktoré pri prehltnutí predstavujú riziko udusenía.

Montáž záhradného domčeka môžu vykonávať len kompetentné osoby, nie deti alebo osoby s obmedzenými intelektuálnymi alebo motorickými zručnosťami alebo nedostatkom skúseností.

Nesprávna manipulácia so záhradným domčekom môže viesť k zraneniam alebo materiálnym škodám.

Venujte zvýšenú opatrnosť vybalovaniu jednotlivých dielov z obalu. **Ostré hrany predstavujú riziko poranenia.**

Jednotlivé diely sú vyrobené z kovu a sú preto ťažké. Pri neopatrnom otváraní obalu, napríklad ostrým nožom alebo iným ostrým/špicatým predmetom, môže dôjsť k poškodeniu dielov. Po rozbalení dielov skontrolujte, či sú všetky jednotlivé diely dodané v správnom množstve. Jednotlivé diely položte na prikrývku alebo niečo podobné, aby ste zabránili poškriabaniu laku.

Skontrolujte, či sú jednotlivé diely v bezchybnom stave, či nevykazujú známky poškodenia, v takom prípade nepoužívajte poškodené a zdeformované časti.

Počas stavby a montáže vždy noste ochranný odev. Medzi jeho základné vybavenie patrí bezpečnostná obuv, ochranné rukavice, bezpečnostné okuliare a prilba.

Nestavajte záhradný domček vo veľmi veternom alebo daždivom počasí.

Skontrolujte, či sa diely nedotýkajú žiadnych napájacích káblov.

Obal, plastové vrecúška alebo ochrannú fóliu zlikvidujte správnym spôsobom a uchovávajte mimo dosahu detí, nebezpečenstvo udusenía!

Záhradný domček položte na rovný povrch.

Počas montáže skontrolujte, či sa v nebezpečnej zóne nenachádzajú žiadne deti.

Neumiestňujte záhradný domček na miesta vystavené silnému alebo trvalému vetru.

Kvôli vašej osobnej bezpečnosti by ste nemali stavať záhradný domček, keď ste unavení, opití alebo intoxikovaní, alebo ak máte závraty alebo nepríjemné pocity.

Ak používate rebríky alebo elektronické zariadenia, uistite sa, že dodržiavate pokyny na použitie, odporúčané ich výrobcami. Horúce zariadenia, ako sú grily, ohrievače, horáky atď. sa v záhradnom domčeku nesmú používať ani skladovať, nebezpečenstvo požiaru! Počas búrok alebo blýskania nikdy nezostávajú v záhradnom domčeku ani vedľa neho. Hrozí riziko zásahu bleskom.

## STAROSTLIVOSŤ A ÚDRŽBA:

Pravidelne čistite povrch. Ak si všimnete škrabance na povrchu, okamžite ich odstráňte vhodným lakom.

Nepoužívajte agresívne čistiace prostriedky, kefy s kovovými alebo nylonovými štetinami ani ostré alebo kovové nástroje, ako sú nože alebo špachtle. Na čistenie používajte kefy s mäkkými štetinami. Používajte studenú, čistú vodu.

## NÁRADIE A VYBAVENIE:

Ochranné odevy (bezpečnostná obuv, ochranné rukavice, bezpečnostné okuliare, prilba atď.)

Vodováha

Meracie pásmo

Rebrík (vysoký približne 1,5 m)

Kľúč alebo račňový kľúč

Akumulátorové skrutky a vrtáčky s príslušenstvom

Skrutkovač

(nie je súčasťou dodávky)

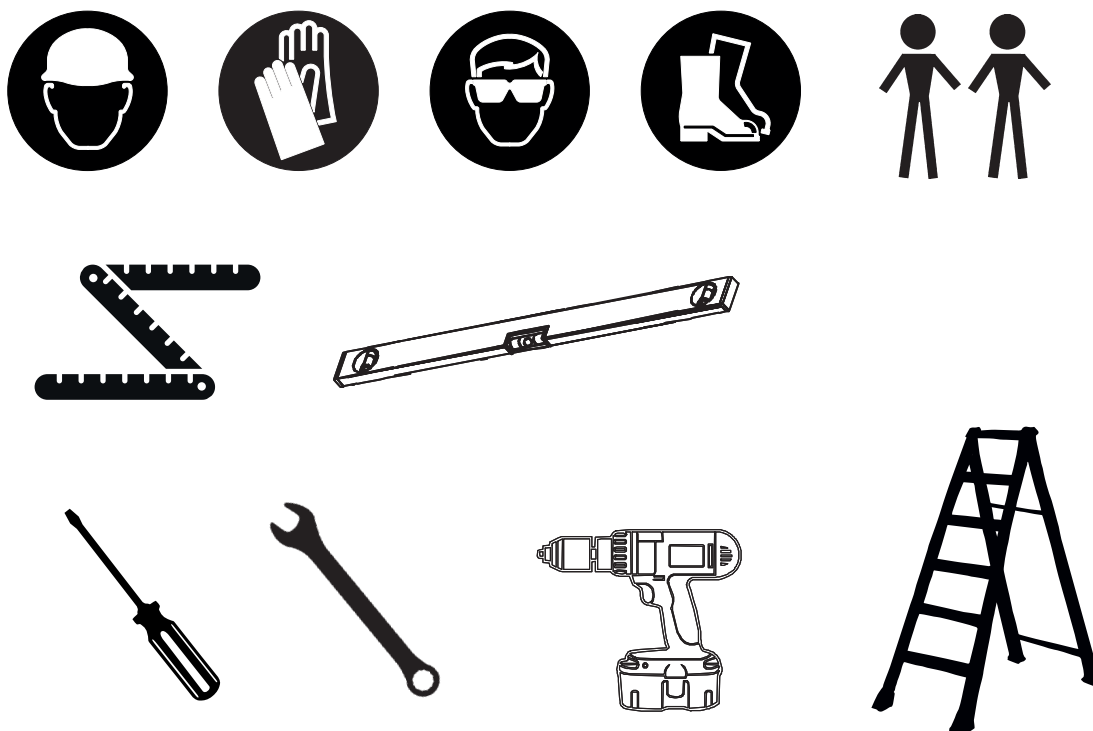

SK

## LIKVIDÁCIA OBALU:

Balenie zlikvidujte podľa jeho typu.

Kartón a lepenku likvidujte ako odpadový papier a fólie odneste do príslušného recyklačného strediska.

## LIKVIDÁCIA ZÁHRADNÉHO DOMČEKA:



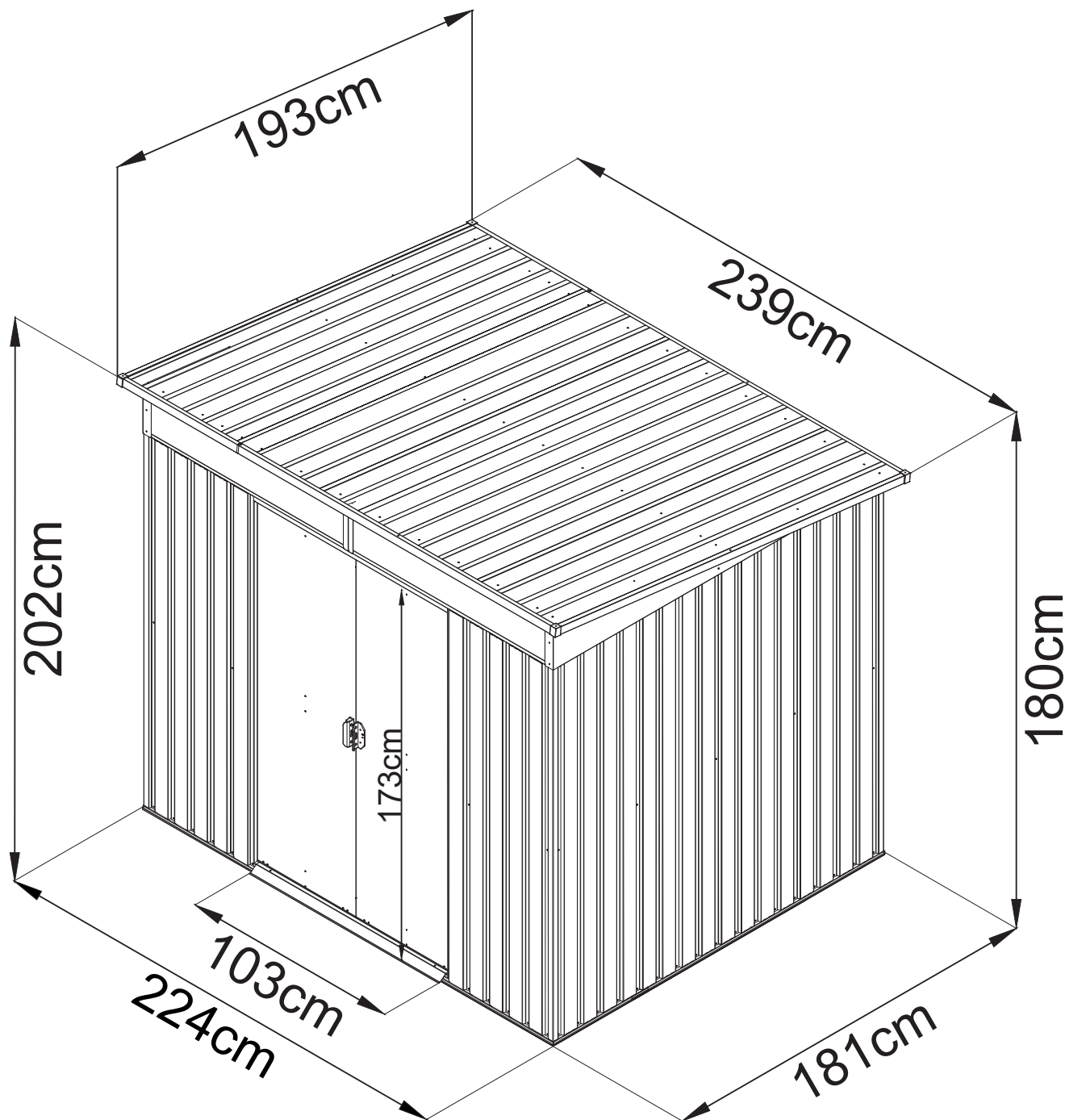

Pri likvidácii záhradného domčeka dbajte o pokyny, zákony a nariadenia týkajúce sa likvidácie vo vašej krajine alebo štáte.





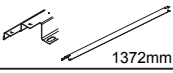
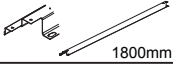
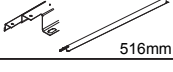
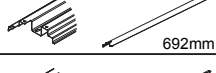
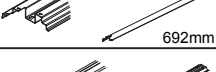
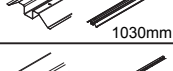
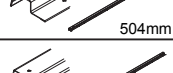
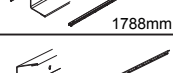
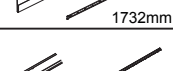
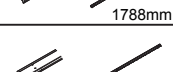
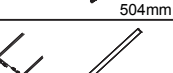
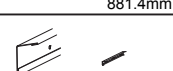

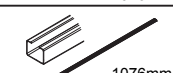
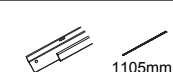
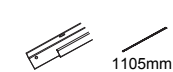
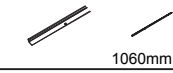
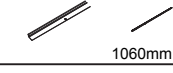
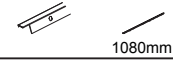
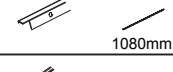
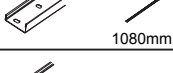

**ROZMERY**

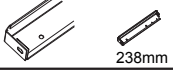
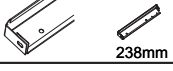
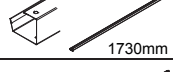
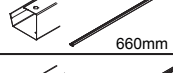
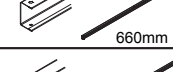
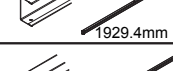
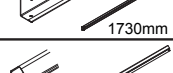
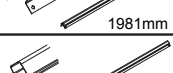
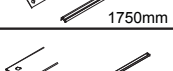
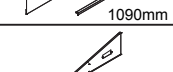

**SK**

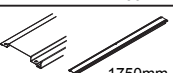
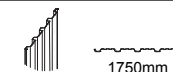
# ZOZNAM ČASTÍ

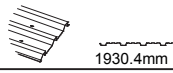
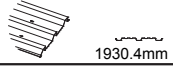
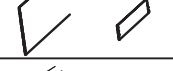
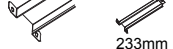









ČÍSLO	ČASTÍ	MNOŽSTVO
1	 1372mm	2
2	 1800mm	1
1-1	 516mm	3
3L	 692mm	1
3R	 692mm	1
5	 1030mm	1
9-1	 504mm	1
9	 1788mm	1
20	 1732mm	2
11	 1788mm	1
11-1	 504mm	1
11-2	 881.4mm	1
B1	 128mm	2
7L	 1076mm	1
7R	 1076mm	1
12L	 1105mm	1
12R	 1105mm	1
14L	 1060mm	1
14R	 1060mm	1
15L	 1080mm	1
15R	 1080mm	1
16L	 1080mm	1
16R	 1080mm	1



ČÍSLO	ČASTÍ	MNOŽSTVO
19L	 238mm	1
19R	 238mm	1
10	 1730mm	1
10-1	 660mm	1
17-1	 660mm	1
17-2	 1929.4mm	2
17	 1730mm	1
13	 1981mm	2
13-1	 1750mm	2
6	 1090mm	1
21L		1
21R		1
18	 566mm	6
4L	 1750mm	1
4R	 1750mm	1
P1	 1750mm	15
P2	 1930.4mm	2
P3	 1930.4mm	3
P4	 1930.4mm	1
P5		2
22	 233mm	2

SK



## ZOZNAM ČASTÍ

ČÍSLO	ČASTÍ	MNOŽSTVO
G2		4
GD		4
GB		2
GC		4
GS		2
F1		310
F2		58
F3		8
S2		167
S3		252

ČÍSLO	ČASTÍ	MNOŽSTVO
D1	 1740X570mm	1
D2	 1740X570mm	1

SK

# PREHĽAD MONTÁŽE

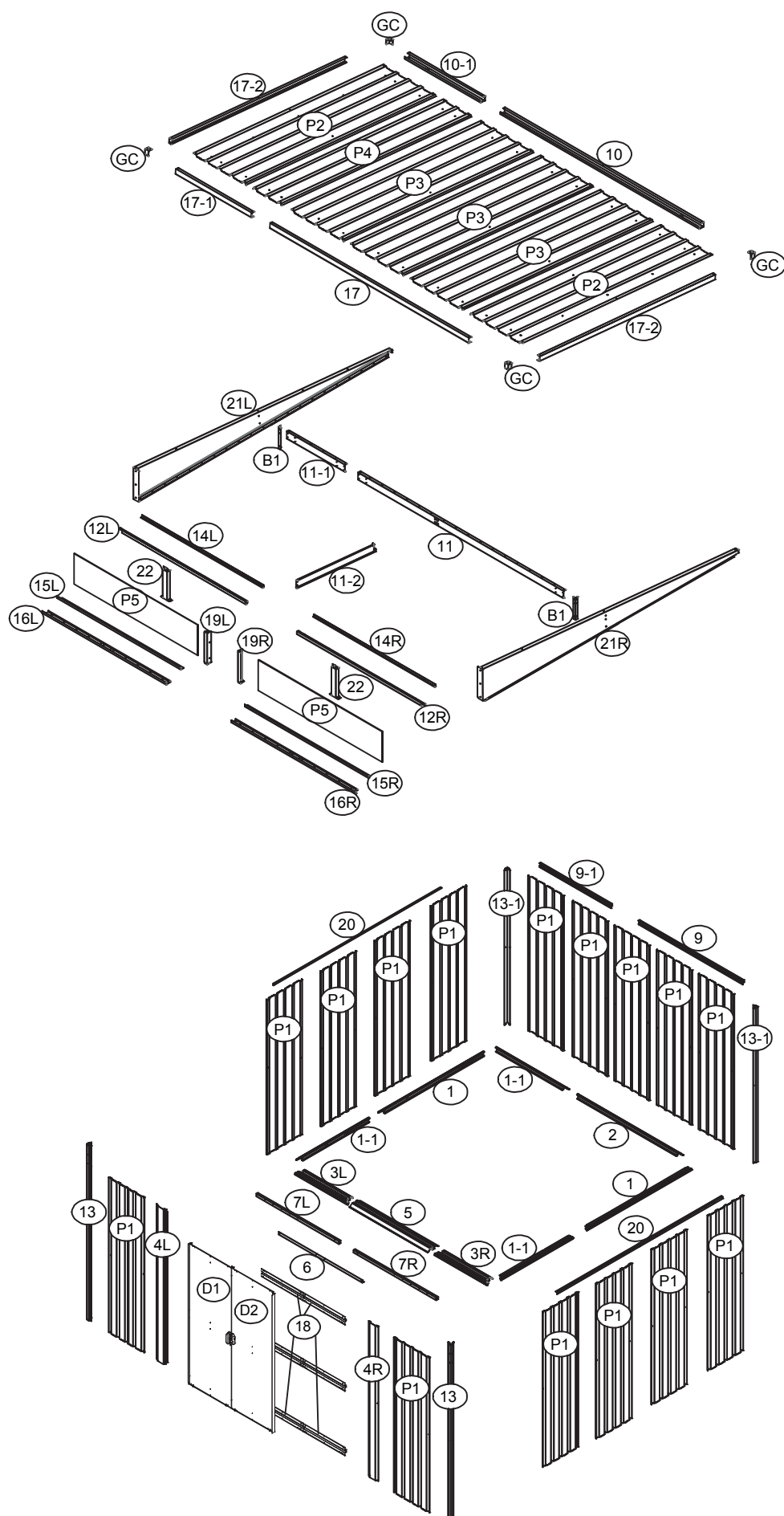

## FÖRRÅD MED LIGHTLINE PULPETTAK MONTERINGSANVISNING

Mått: L x B x H 239 x 193 x 202 cm

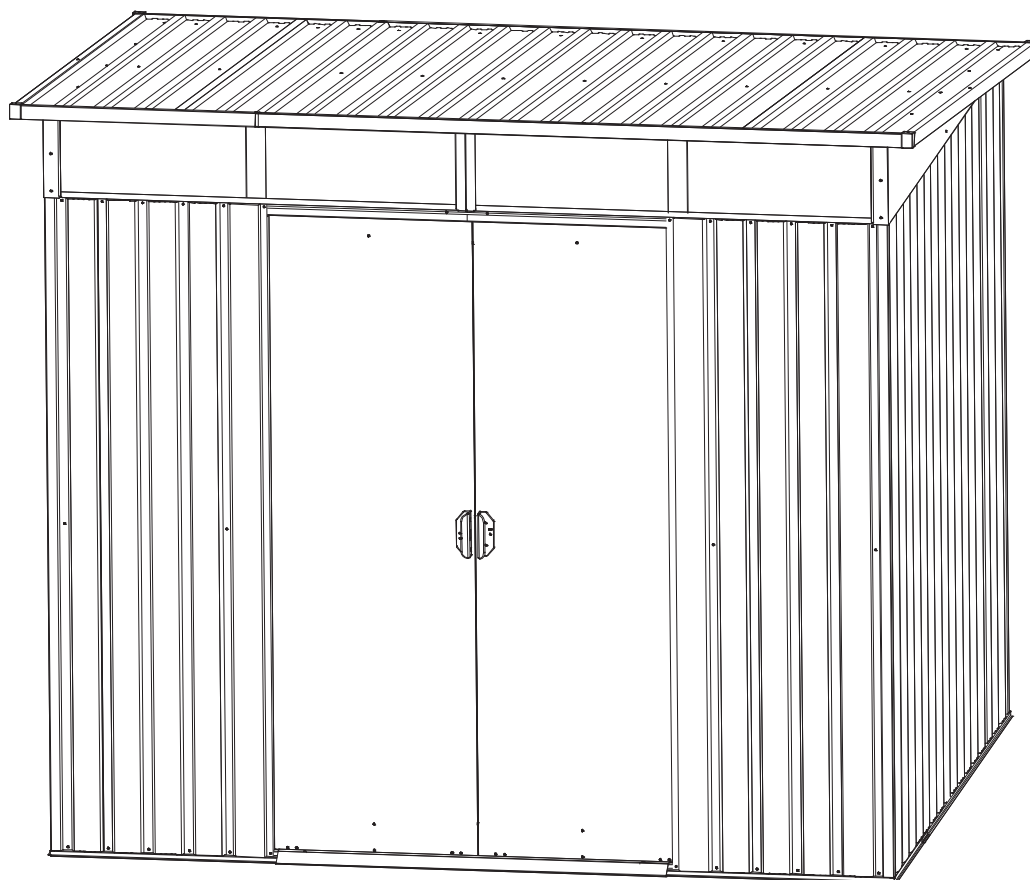

SE

### INFORMATION

Läs igenom monteringsanvisningen noga innan du börjar montera förrådet.  
Detta gäller i synnerhet säkerhetsanvisningarna.  
Annars kan det leda till personskador eller skador på förrådet.  
Förrådet är ingen klätterställning för barn och ingen spaljé – risk för överbelastning!  
Säkerställ att alla nödvändiga delar finns i angiven mängd.  
Sätt ihop delarna i angiven ordningsföljd enligt instruktionerna i den medföljande monteringsanvisningen noga.  
Hoppa inte över eller förenkla angivna steg.  
Förvara monteringsanvisningen på en säker plats för senare användning.

## ALLMÄN INFORMATION

Innan du påbörjar monteringen ska du säkerställa att du följer gällande riktlinjer/bestämmelser.

Räkna med minst 390–450 minuter för monteringen.

Det krävs minst två personer för att montera produkten. Kontrollera innan arbetet påbörjas att alla delar finns i angiven mängd. Montera produkten på en öppen, solig plats utan överskjutande grenar.

Kontrollera att de enskilda delarna är oskadda och lägg dem så att du enkelt kan nå dem under monteringen.

Lägg gärna smådelar såsom skruvar, muttrar osv. i en skål så att de inte försvinner.

Förrådet ska under inga omständigheter användas som klättringshjälp för baljväxter, kläng- och slingerväxter, frukt, grönsaker eller som hållare för tvättlinan.

Håll förrådet fritt från snö och löv. **Max. bärformåga: 90 kg/m<sup>2</sup>.**

Använd förrådet uteslutande så som beskrivet i monteringsanvisningen.

Tillverkaren eller återförsäljaren ansvarar inte för skador som kan uppstå på grund av olämplig eller felaktig användning.

Placera inte förrådet direkt på en gräsmatta eller ett ojämnt underlag; säkerställ ett lämpligt hållbart, vågrätt och stabilt underlag. Vi rekommenderar att du förankrar förrådet i underlaget.

Säkerställ att alla skruvar är åtdragna och att ramen är korrekt anpassad och vågrät. Kontrollera regelbundet att alla skruvar är åtdragna och dra åt eventuellt lösa skruvar vid behov.

**Vissa metalldelar har försetts med en skyddsfolie. Avlägsna denna folie försiktigt innan du påbörjar monteringen.**

## SÄKERHETSANVISNINGAR

Stå aldrig direkt på takytan, det finns risk för överbelastning. Inte heller vid montering eller vid rengöring.

Det finns risk för skada på barn och personer med nedsatt känsel, fysisk eller psykisk kapacitet (t.ex. uttröttade personer, personer med funktionsnedsättning, äldre personer med nedsatt fysisk och psykisk kapacitet) eller bristande erfarenhet och kunskap (t.ex. äldre barn). Små delar såsom skruvar och muttrar för montering av förrådet medföljer och kan orsaka kvävning om de sväljs.

Förrådet ska enbart monteras av yrkeskunniga personer, inte av barn eller personer med nedsatt känsel eller motorik eller bristande erfarenhet.

Felaktig hantering/användning av förrådet kan leda till personskador eller materiella skador.

Var försiktig när du packar upp de enskilda delarna ur förpackningen.

**Det finns en skaderisk på grund av vassa kanter.**

Vissa delar består av metall och är därför tunga. Vid oförsiktigt öppnande av förpackningen, t.ex. med en vass sax eller ett annat vasst eller spetsigt föremål, riskerar du att skada delarna. Efter upppackning, kontrollera att alla delar finns i angiven mängd. Lägg de enskilda delarna på en filt eller liknande för att undvika repor i beläggningen.

Kontrollera att de olika delarna är i gott skick och oskadda – skadade eller deformerade delar ska inte användas.

Använd alltid personlig skyddsutrustning under monteringen. Till grundutrustningen hör skyddsskor, skyddshandskar, skyddsglasögon och hjälm.

Installera inte förrådet om det blåser eller regnar kraftigt.

Säkerställ att delarna inte nuddar någon strömkabel.

Kassera förpackning, plastpåse eller skyddsfolie på lämpligt sätt och förvara dessa utom räckhåll för barn – kvävningsrisk!

Placera förrådet på ett jämnt underlag.

Säkerställ att inga barn befinner sig i riskområdet under monteringen.

Placera inte förrådet i områden som utsätts för stark eller ihållande vind.

För din egen säkerhet ska du inte montera förrådet om du är trött, berusad eller påverkad, eller när du känner dig yr eller illamående.

Vid användning av stegar eller elektroniska apparater ska tillverkarens anvisningar alltid följas.

Varma apparater, som grillar, element, brännare osv., ska inte användas eller förvaras i närheten av förrådet – brandrisk!

Stå aldrig inuti eller under förrådet vid oväder eller åskväder – risk för blixtnedslag!

## SKÖTSEL OCH UNDERHÅLL

Rengör ytan regelbundet. Upptäcker du repor i beläggningen ska du genast åtgärda dessa med lämpligt lack.

Använd inga aggressiva rengöringsmedel, metall- eller nylonborstar, vassa hjälpmedel eller hjälpmedel av metall såsom kniv eller spatel. Använd en mjuk borste och kallt, rent vatten för att rengöra ytan.

## VERKTYG OCH UTRUSTNING

Skyddskläder (skyddsskor, skyddshandskar, skyddsglasögon, hjälm osv.)

Vattenpass

Längdmått

Stege (ca 1,5 m hög)

Skruv- eller blocknyckel

Skruvdragare och bormaskin med olika tillbehör

Skruvmejsel

(medföljer ej)

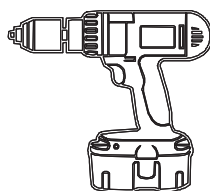
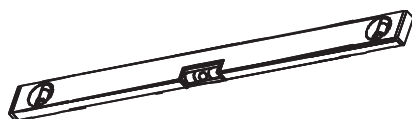

SE

## AVFALLSHANtering AV FÖRPACKNINGEN

Kassera förpackningen som sorterat avfall.

Papper och kartong ska sorteras som returpapper och folie som motsvarande återvinningsbart avfall.

## AVFALLSHANtering AV FÖRRÅDET



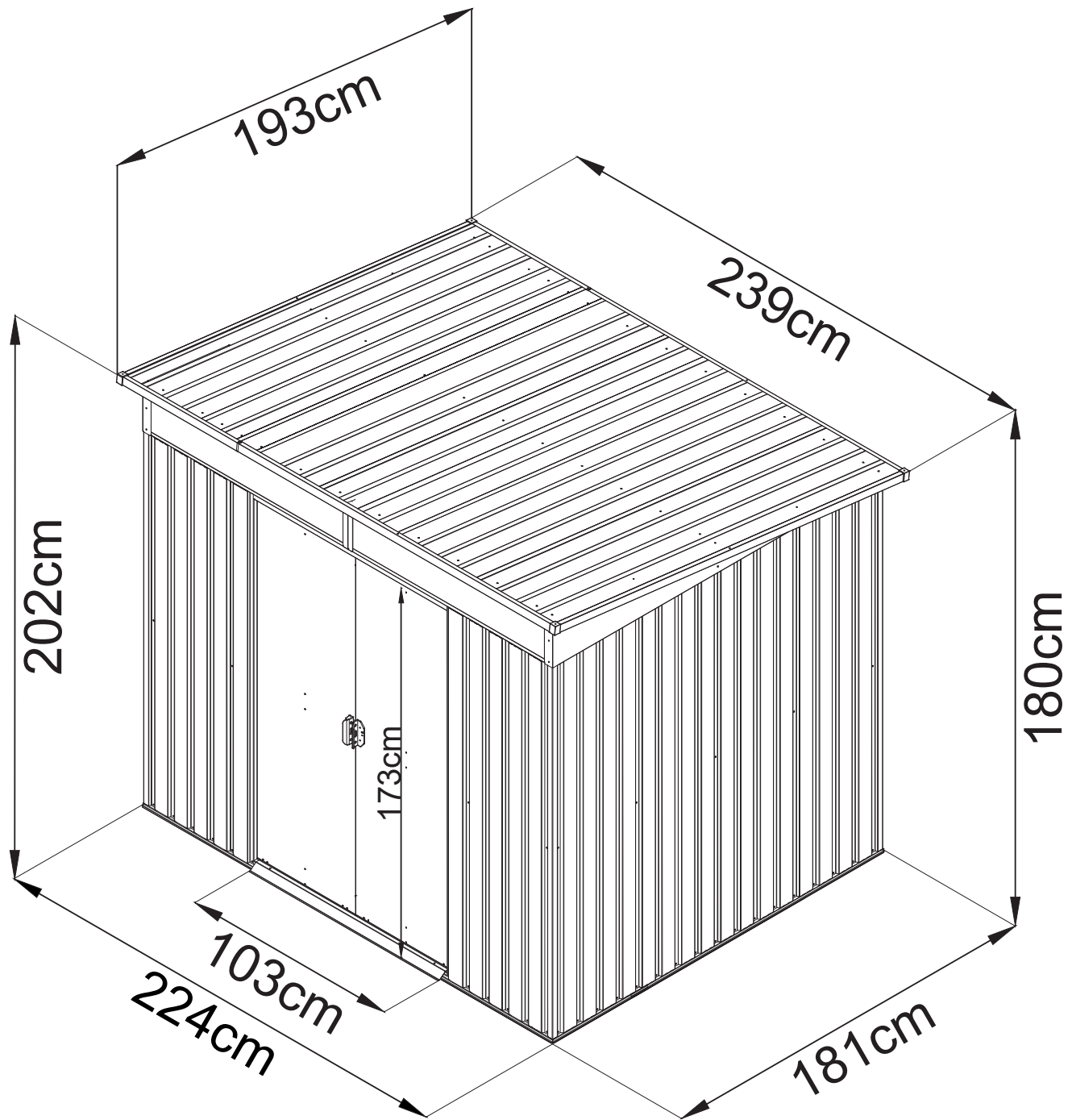

Ta hänsyn till gällande nationella riktlinjer, lagar och bestämmelser för avfallshantering.





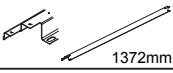
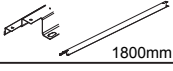
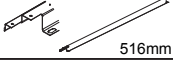
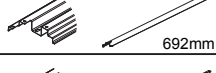
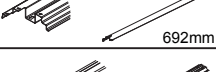
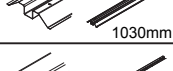
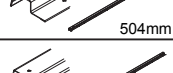
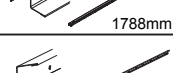
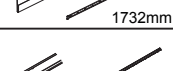
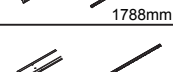
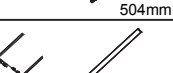
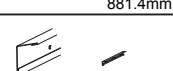

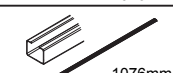
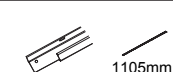
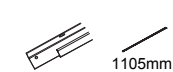
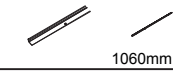
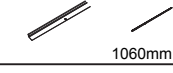
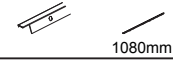
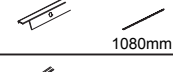
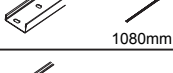

MÅTT

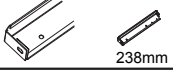
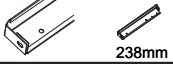
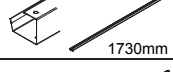
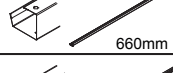
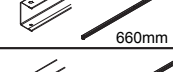
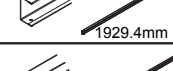
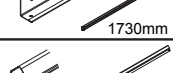
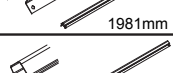
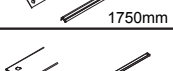
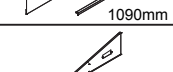



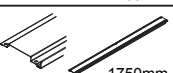
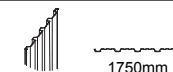

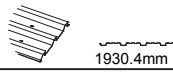
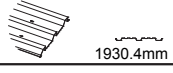
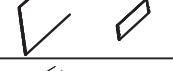
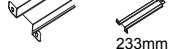





SE



# KOMPONENTLISTA

NR.	DEL	MÄNGD
1	 1372mm	2
2	 1800mm	1
1-1	 516mm	3
3L	 692mm	1
3R	 692mm	1
5	 1030mm	1
9-1	 504mm	1
9	 1788mm	1
20	 1732mm	2
11	 1788mm	1
11-1	 504mm	1
11-2	 881.4mm	1
B1	 128mm	2
7L	 1076mm	1
7R	 1076mm	1
12L	 1105mm	1
12R	 1105mm	1
14L	 1060mm	1
14R	 1060mm	1
15L	 1080mm	1
15R	 1080mm	1
16L	 1080mm	1
16R	 1080mm	1

NR.	DEL	MÄNGD
19L	 238mm	1
19R	 238mm	1
10	 1730mm	1
10-1	 660mm	1
17-1	 660mm	1
17-2	 1929.4mm	2
17	 1730mm	1
13	 1981mm	2
13-1	 1750mm	2
6	 1090mm	1
21L		1
21R		1
18	 566mm	6
4L	 1750mm	1
4R	 1750mm	1
P1	 1750mm	15
P2	 1930.4mm	2
P3	 1930.4mm	3
P4	 1930.4mm	1
P5		2
22	 233mm	2

# KOMPONENTLISTA



NR.	DEL	MÄNGD
G2		4
GD		4
GB		2
GC		4
GS		2
F1		310
F2		58
F3		8
S2		167
S3		252

NR.	DEL	MÄNGD
D1	 1740X570mm	1
D2	 1740X570mm	1



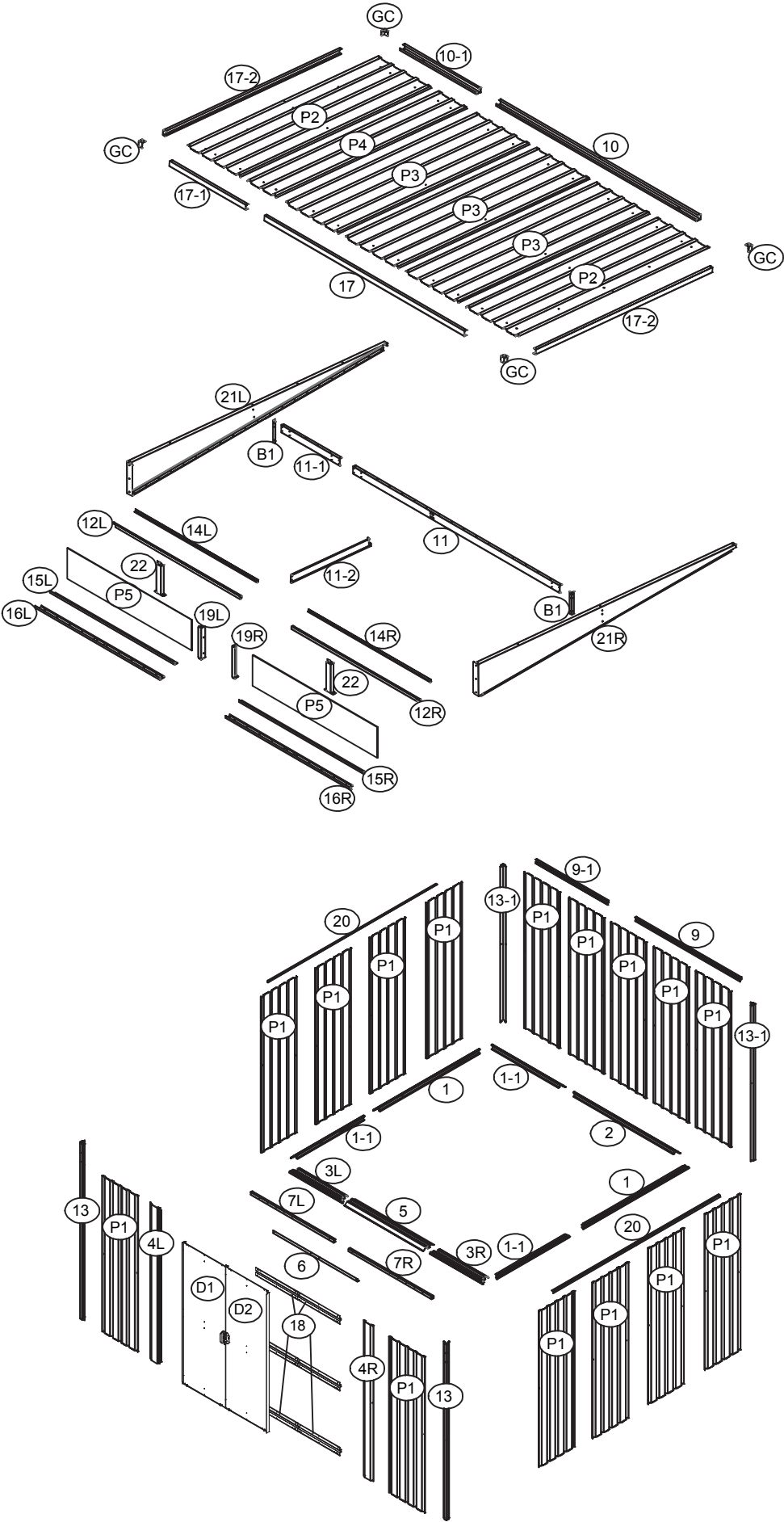

# MONTERINGSÖVERSIKT

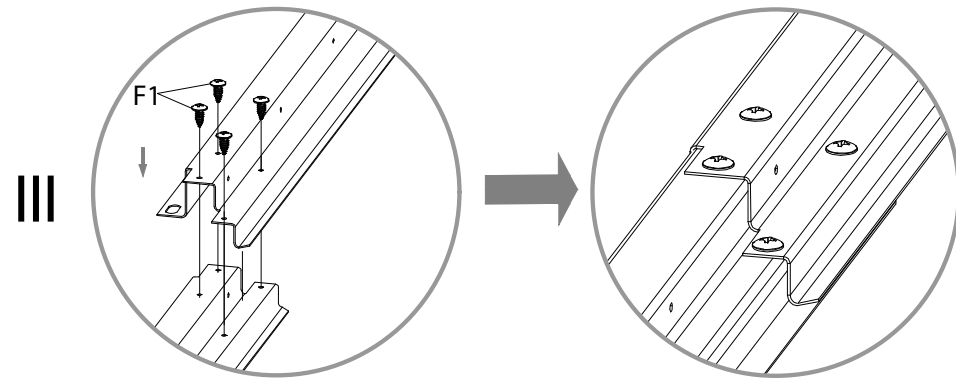
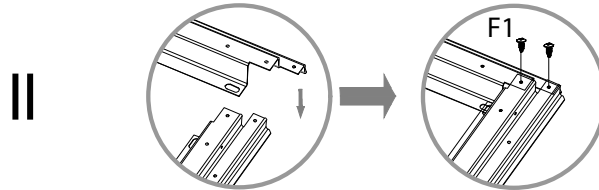
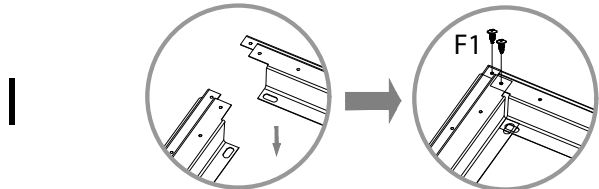
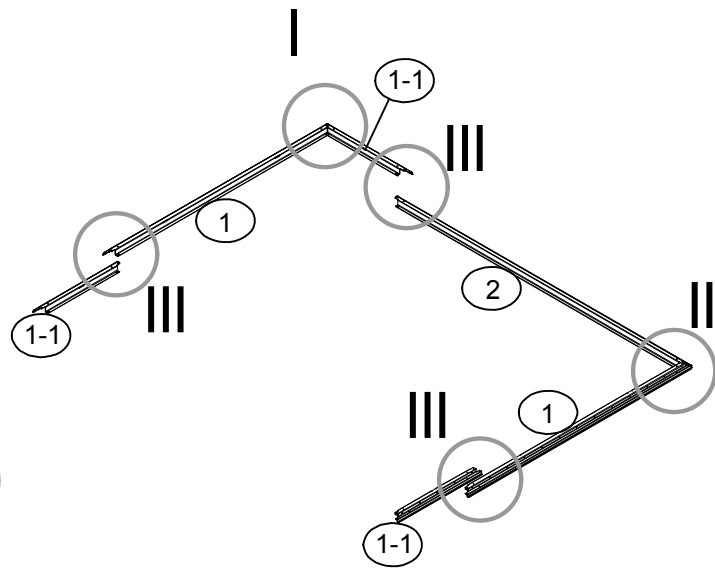

1		2x
2		1x
1-1		3x



**1**

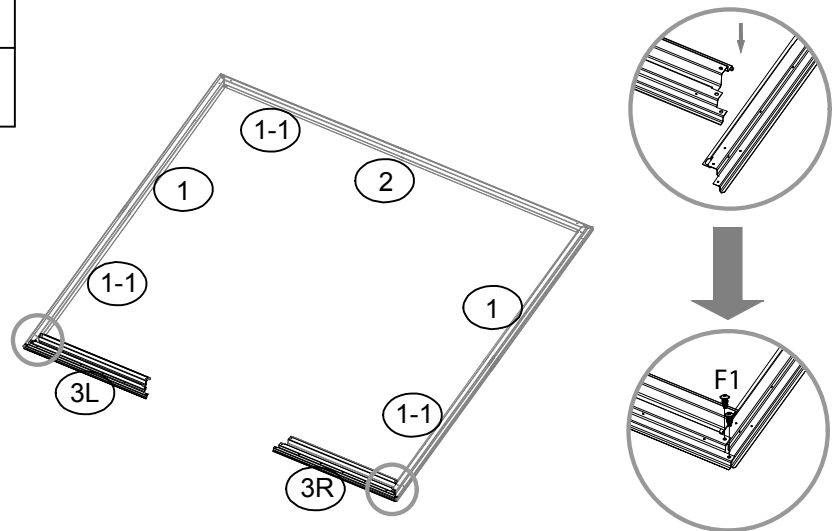

3L		1x
3R		1x

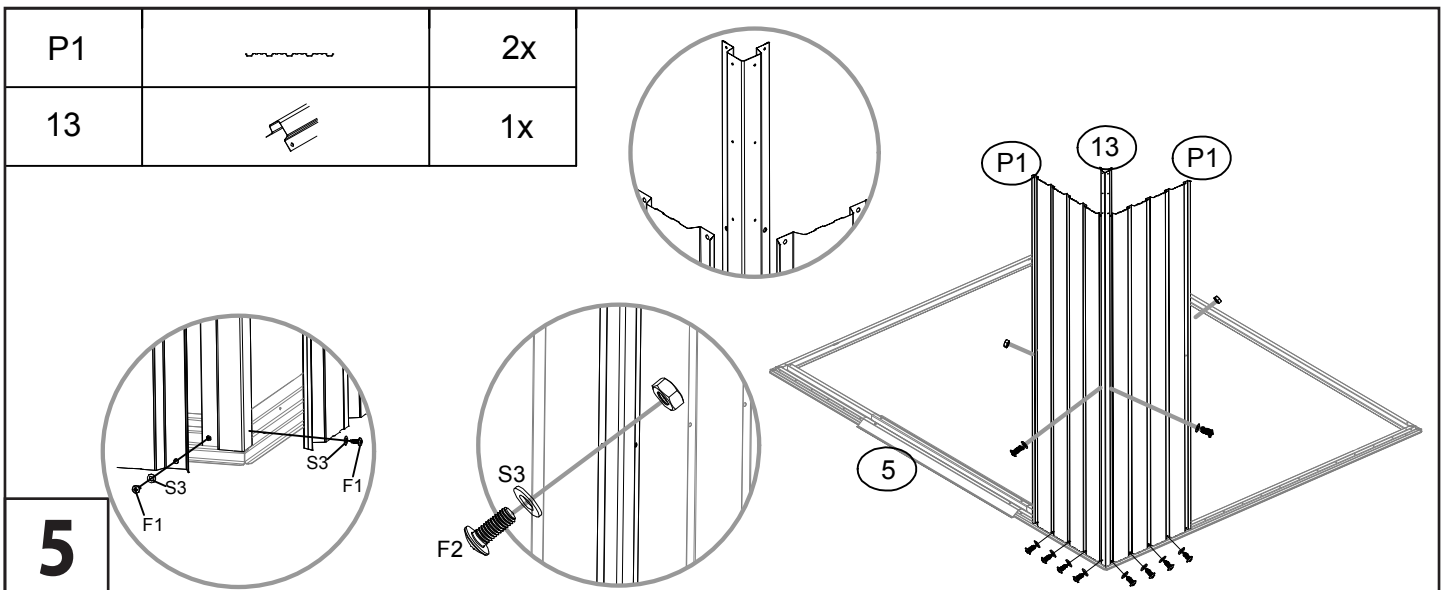
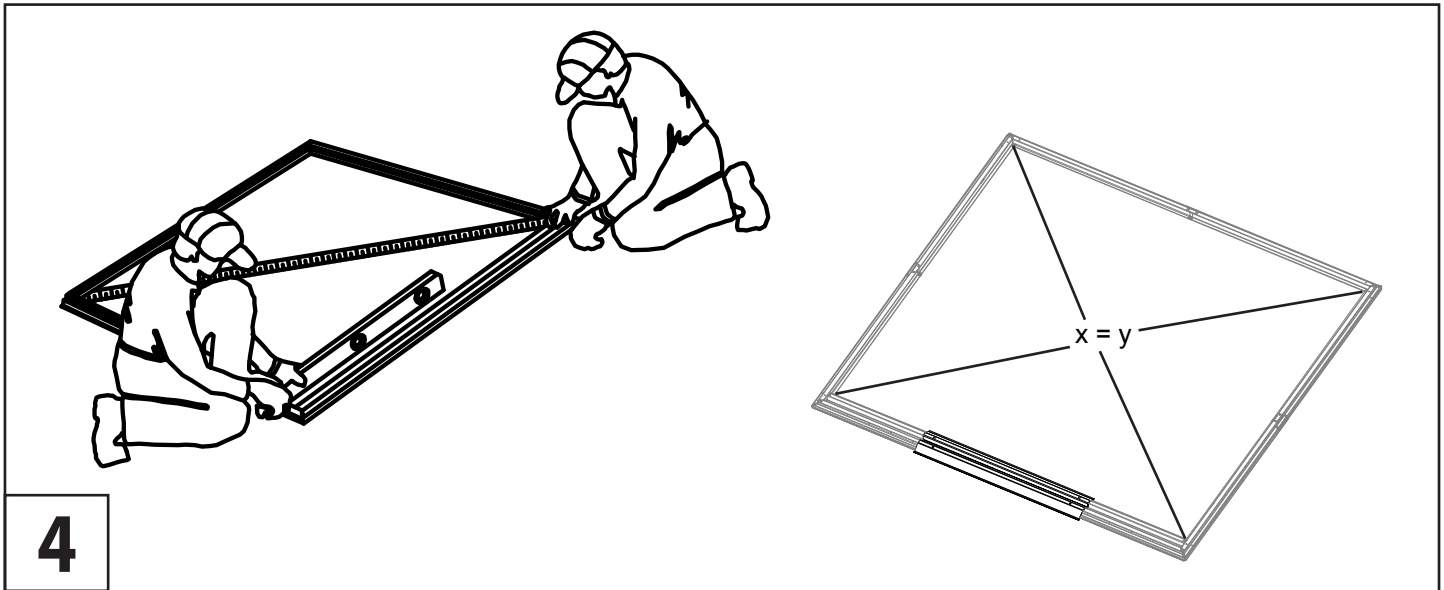
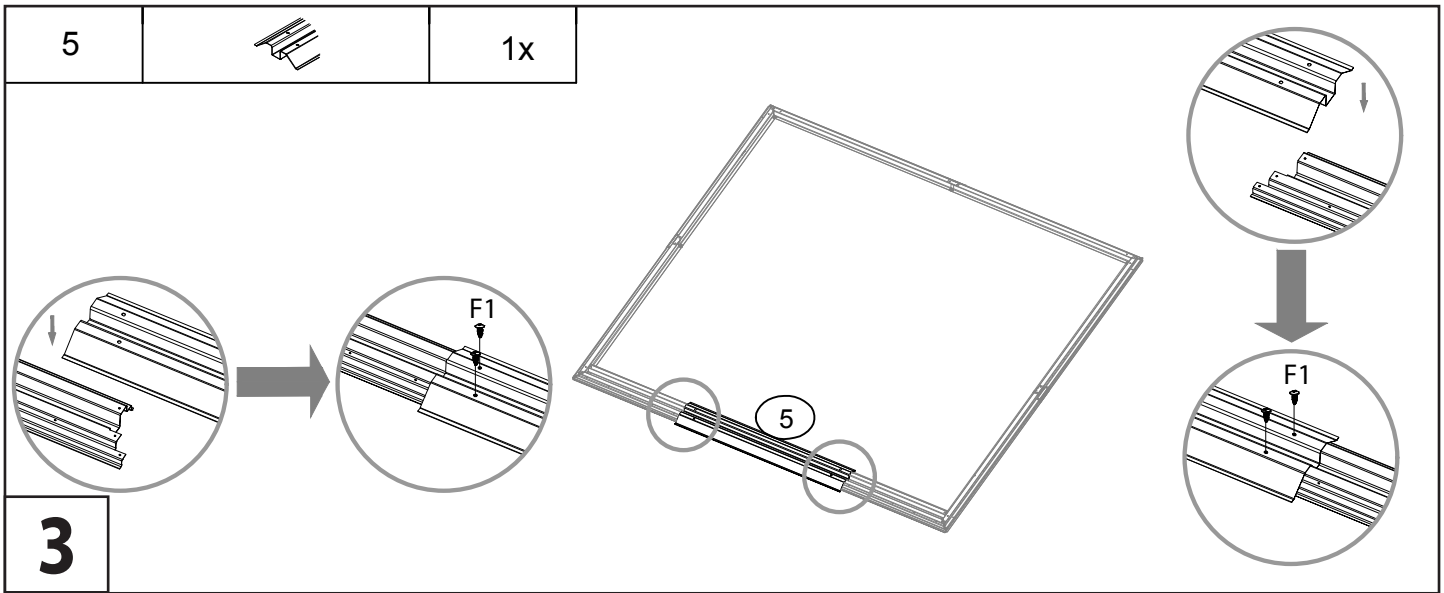

**2**

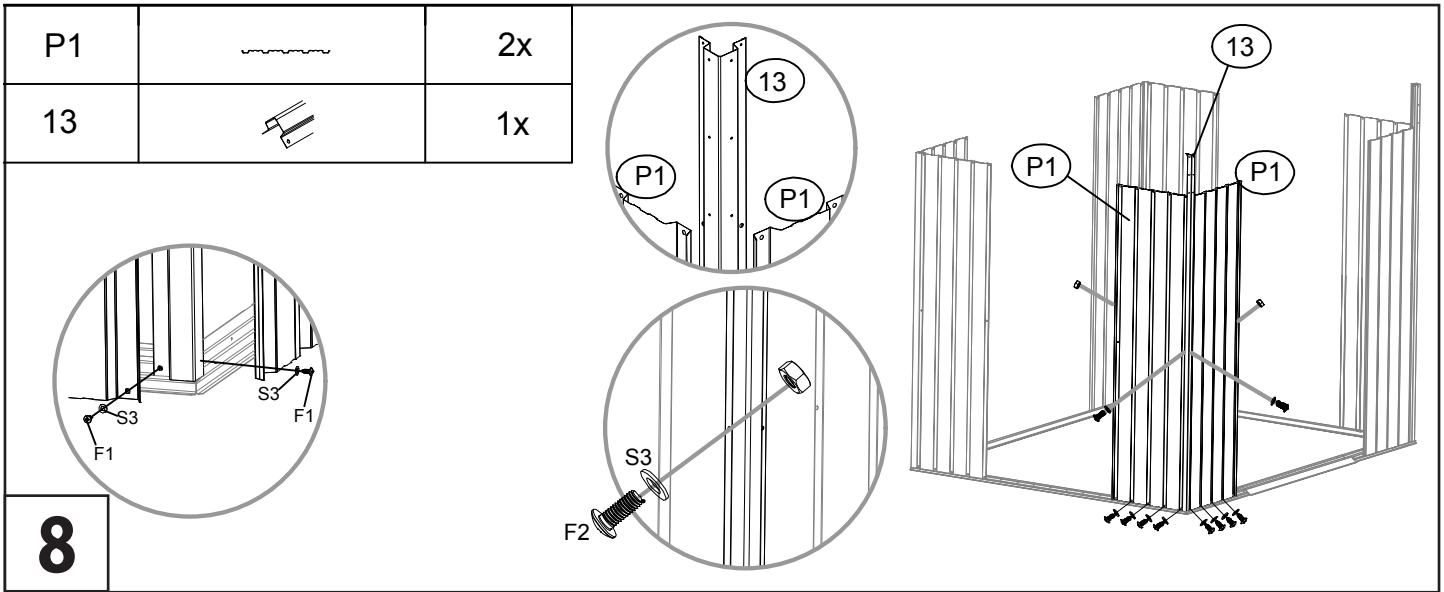
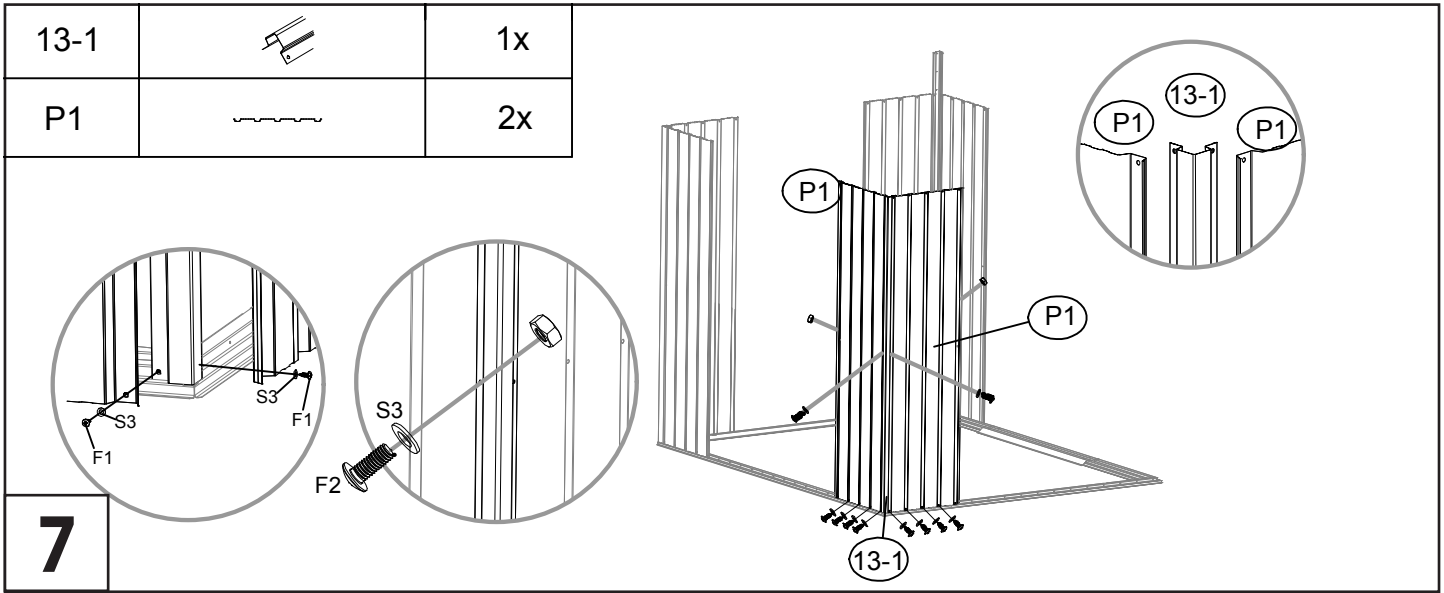
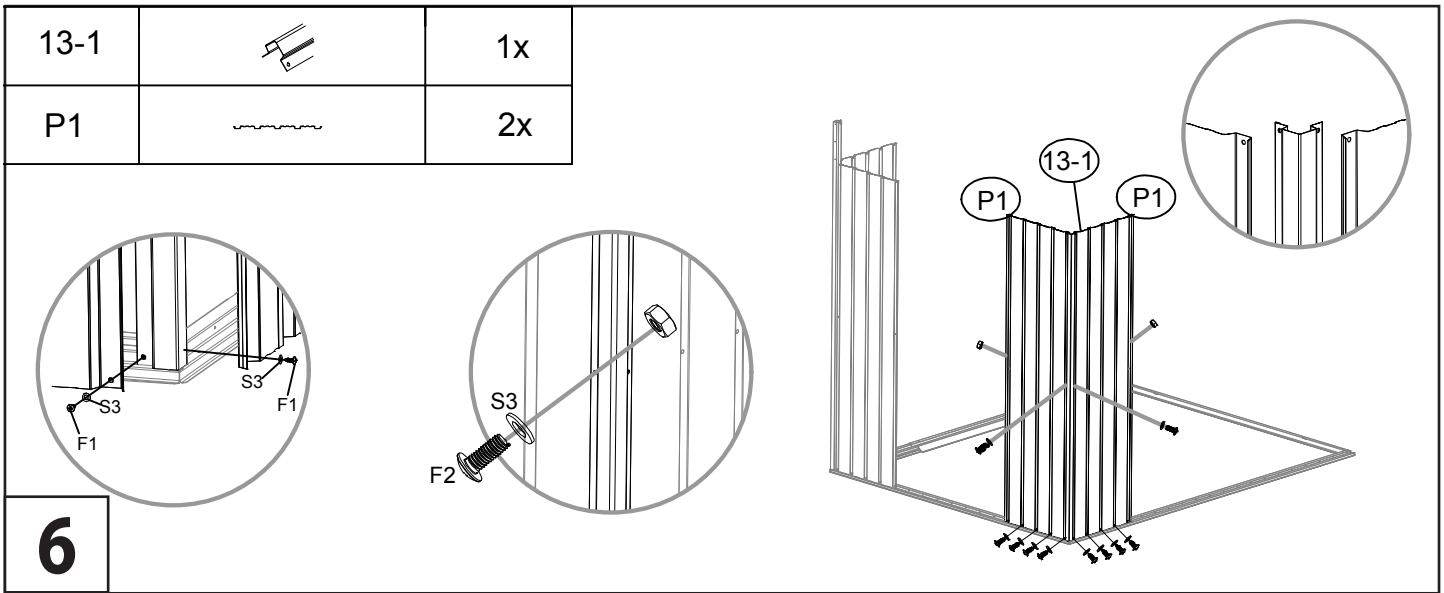



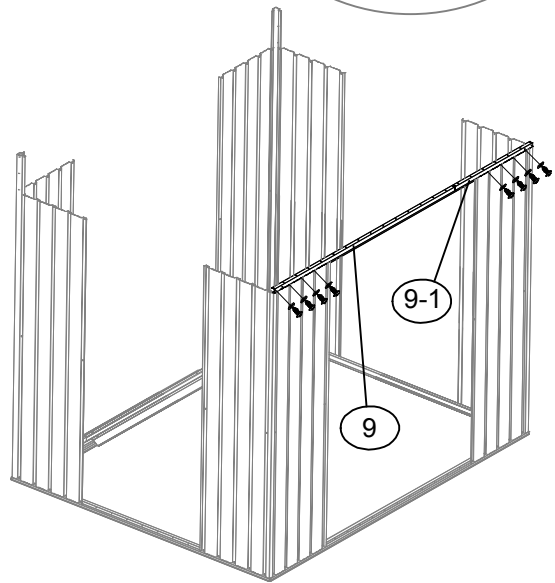
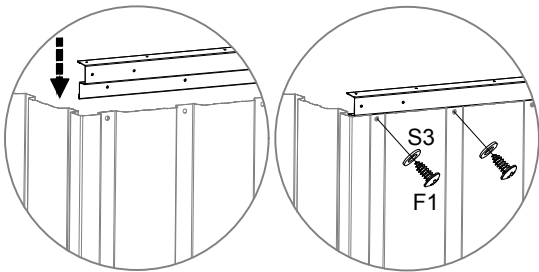
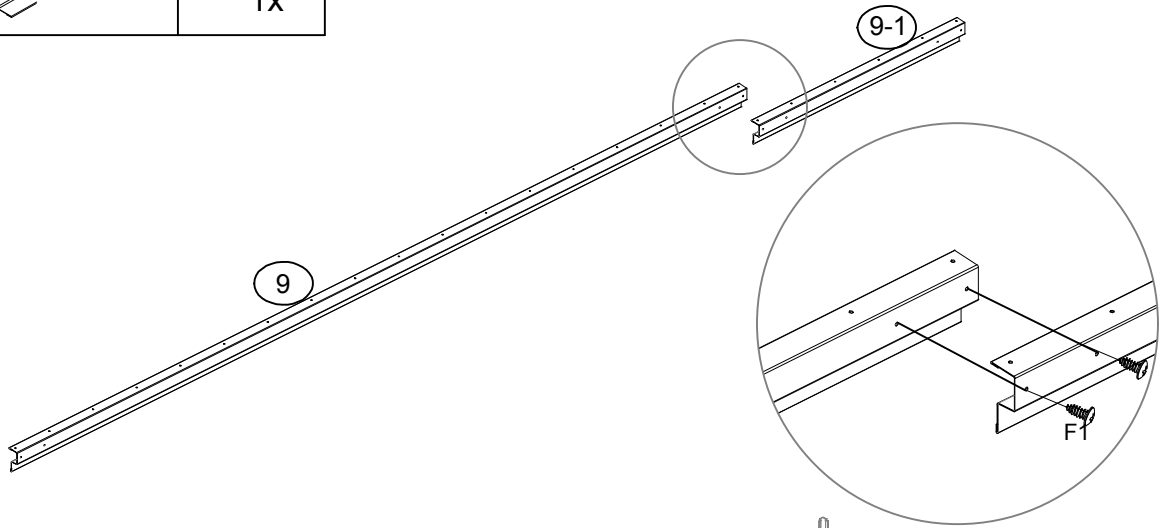

9		1x
9-1		1x



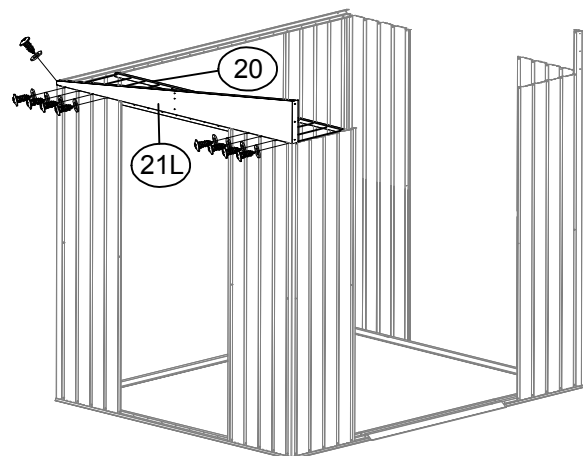
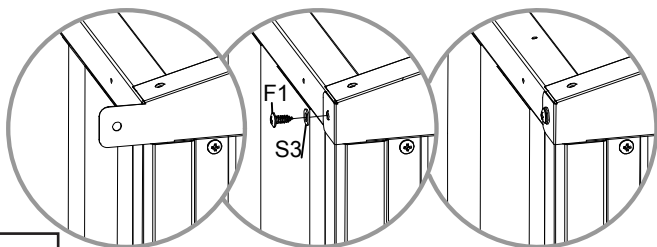

**9**

21L		1x
20		1x



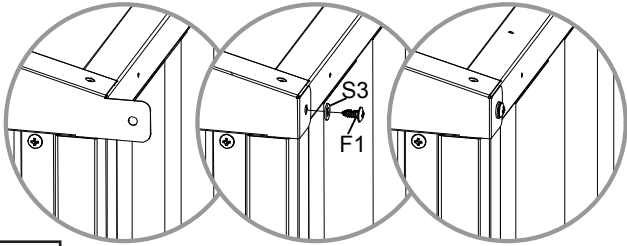

**10**

21R		1x
20		1x



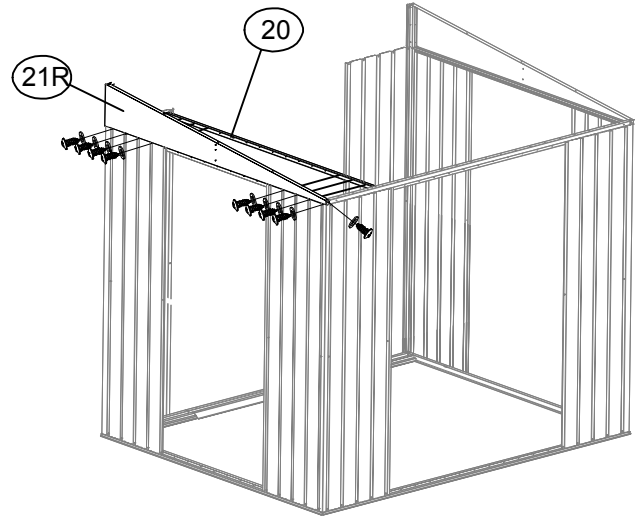



**11**

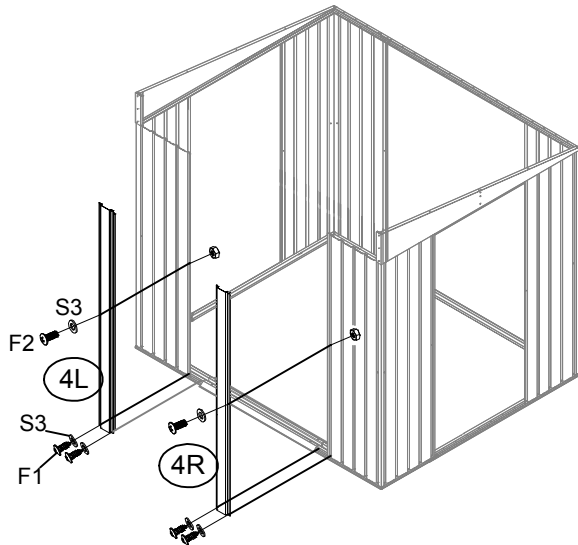

4L		1x
4R		1x



**12**

7L		1x
7R		1x
6		1x
G2		4x

7L&7R

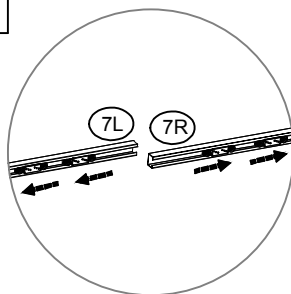
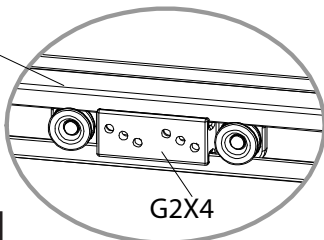

**13**

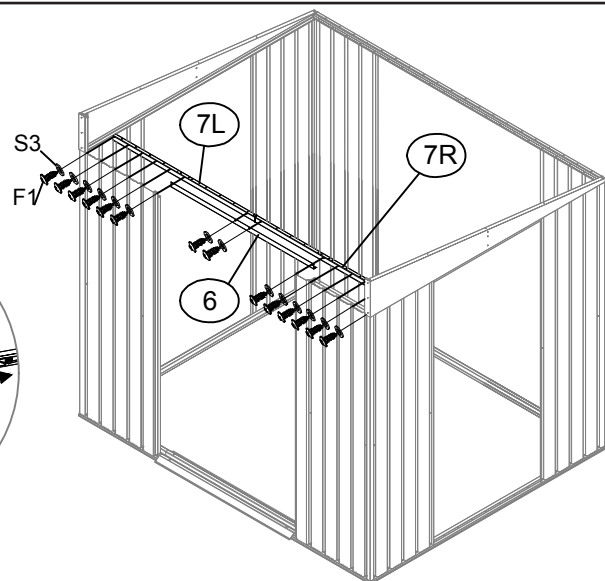

15R		1x
16R		1x
19R		1x

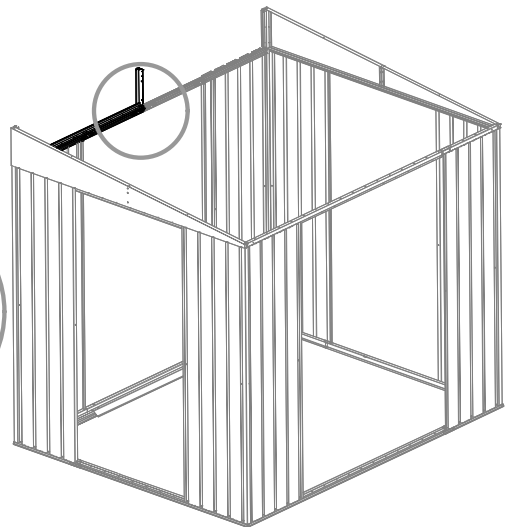
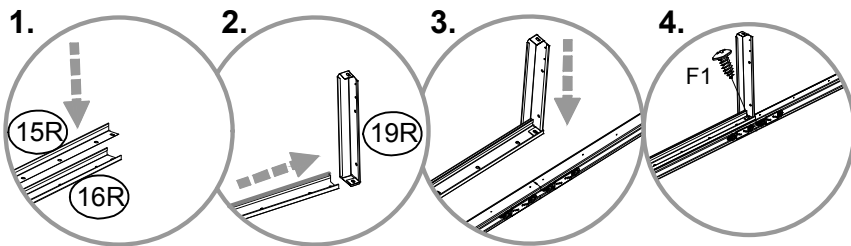

**14**

15L		1x
16L		1x
19L		1x

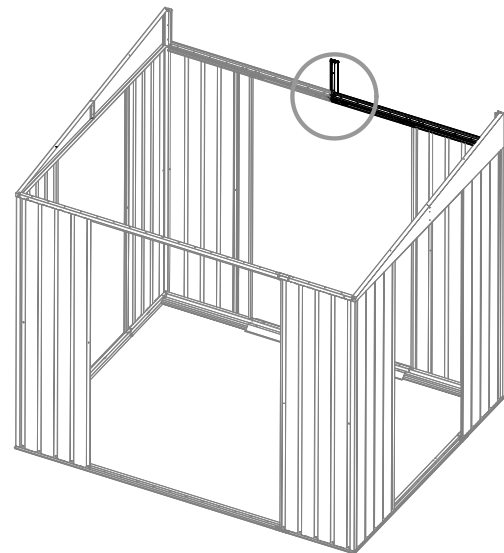
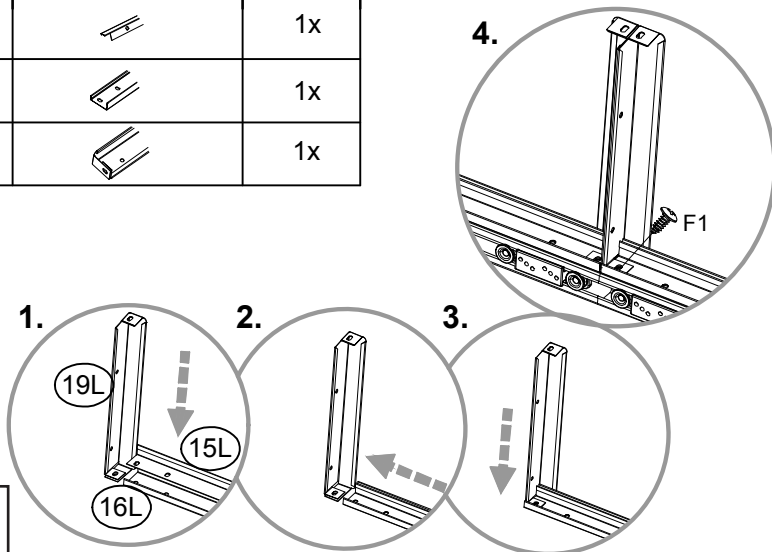

**15**

P5		2x
----	--	----

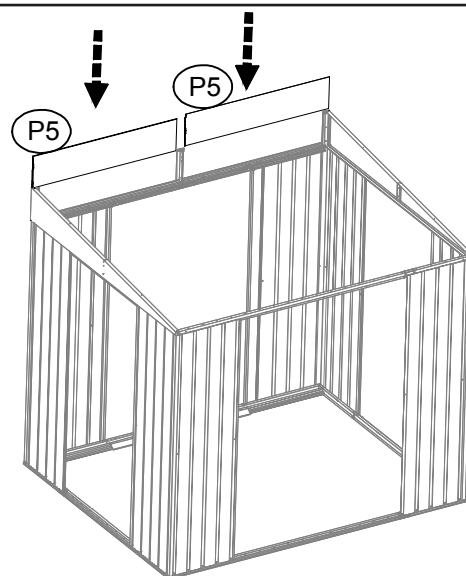
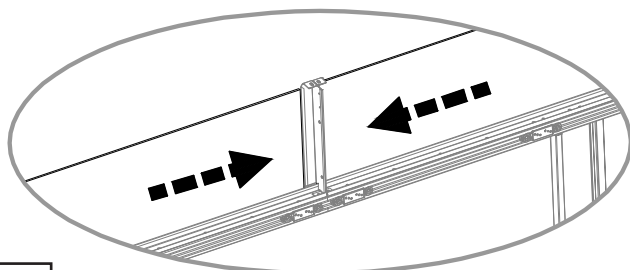

**16**

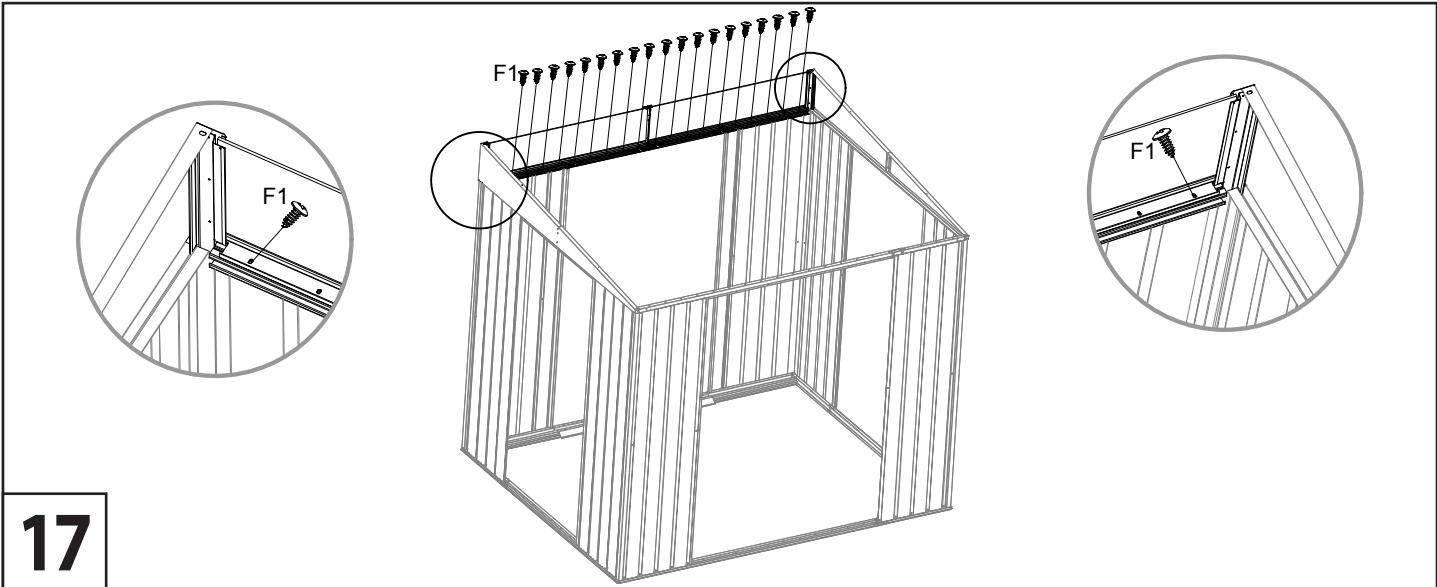

**17**

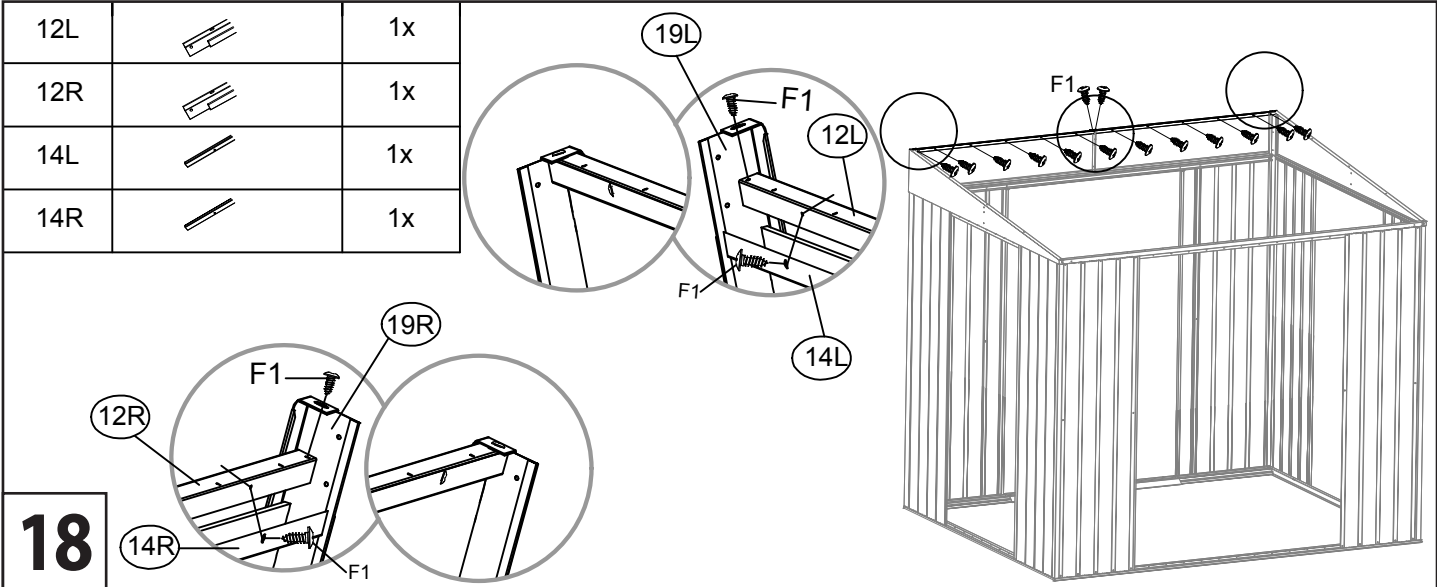

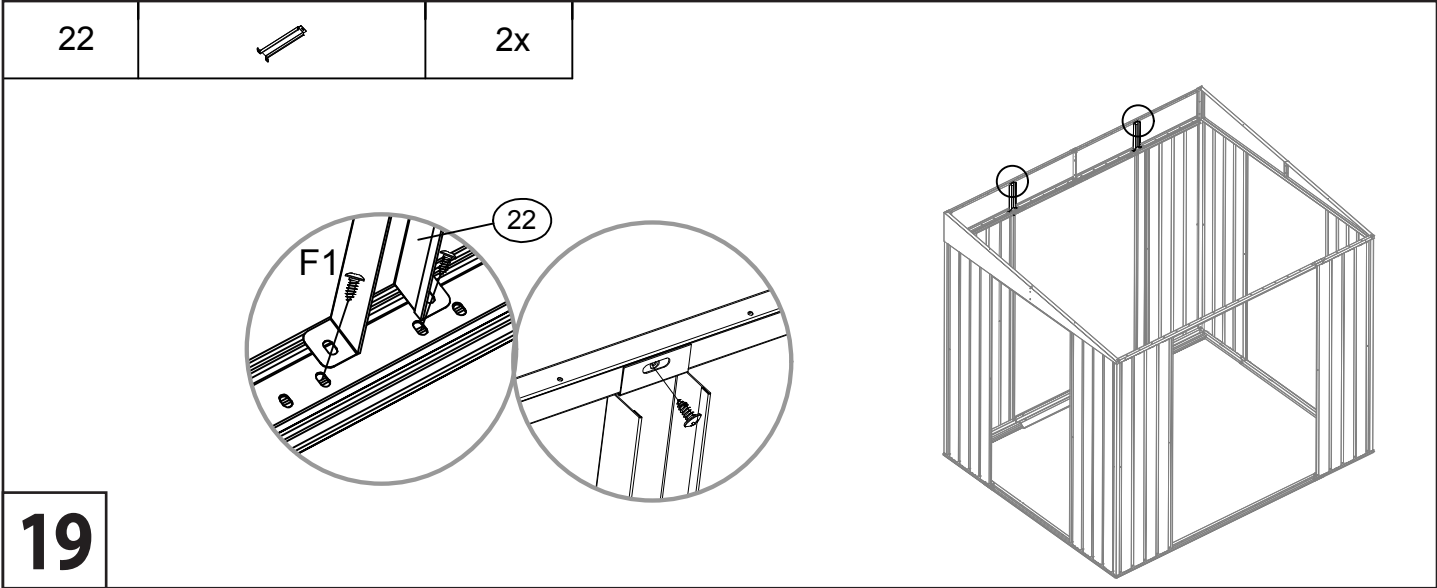

**18**



**19**

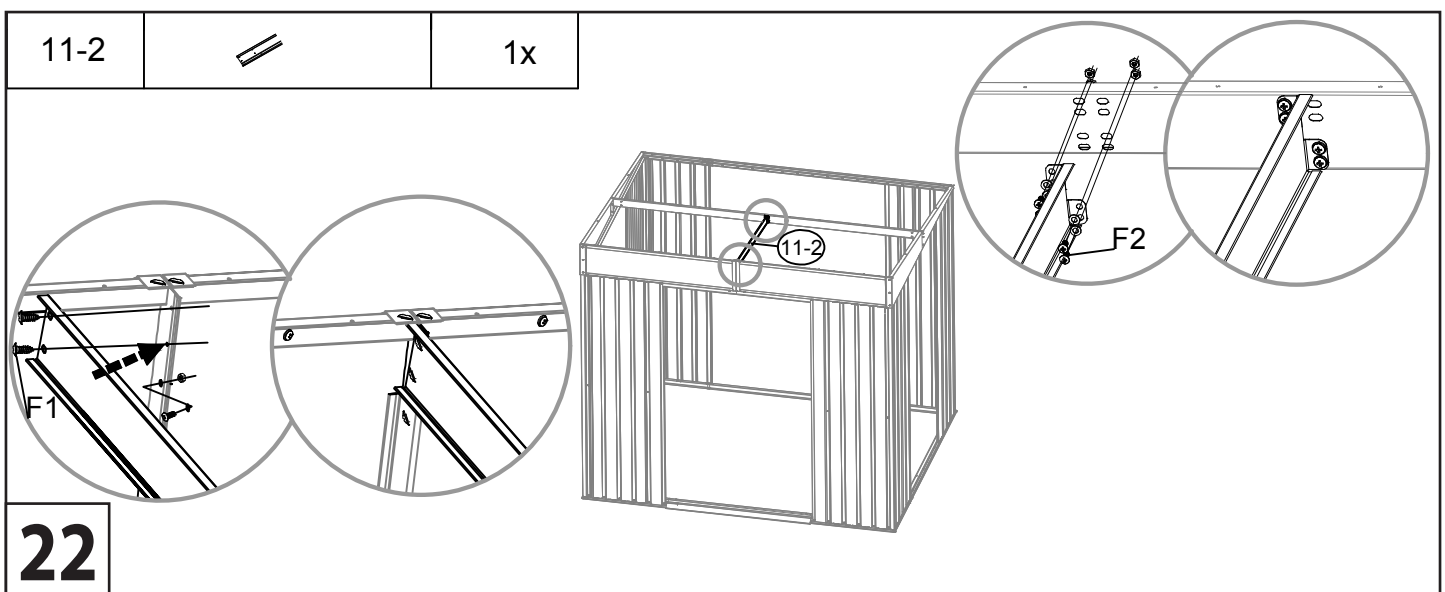
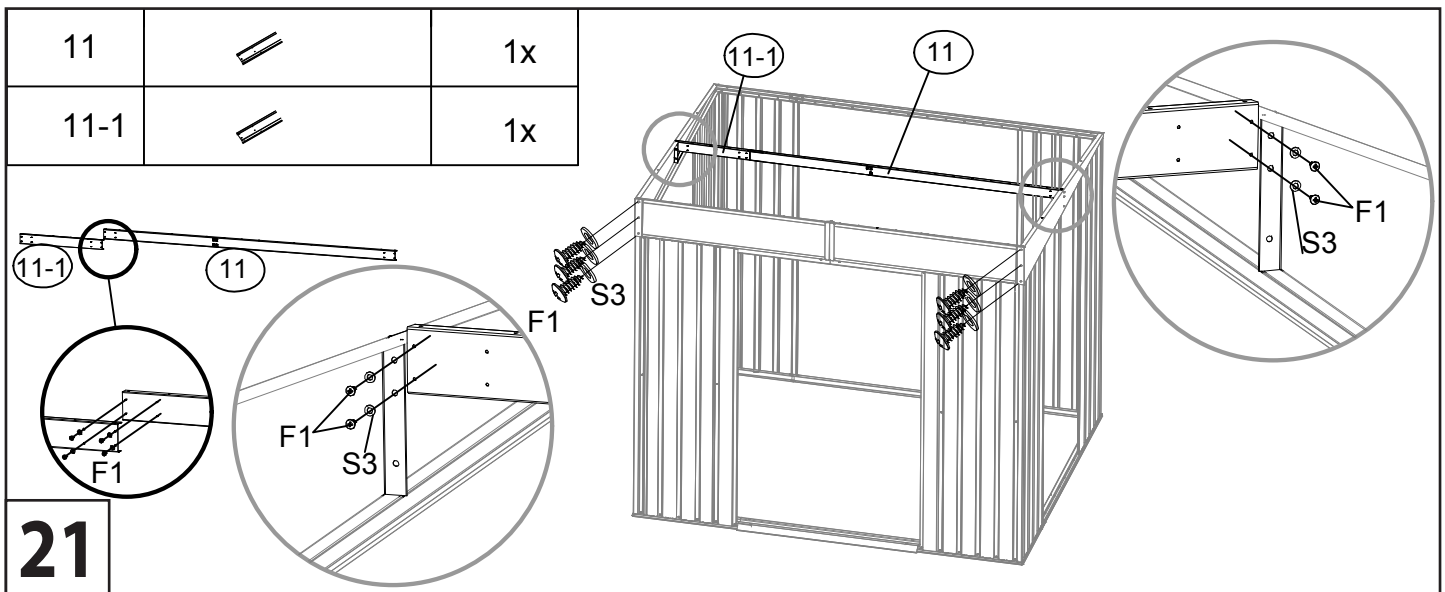
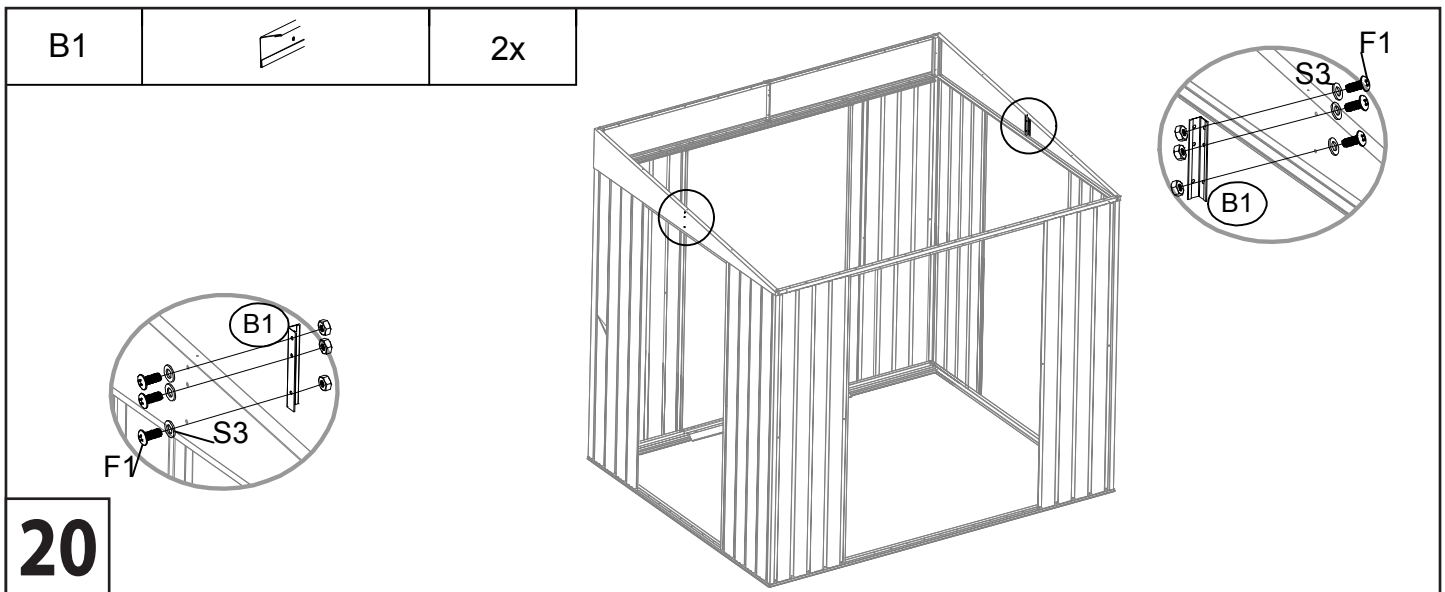





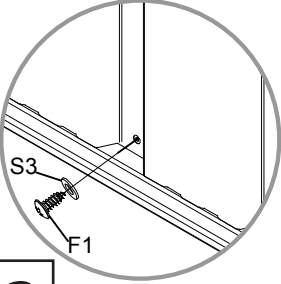

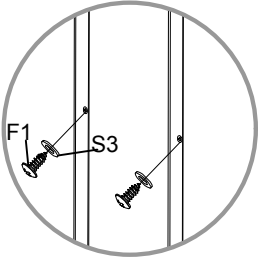
P1		7x
----	---	----

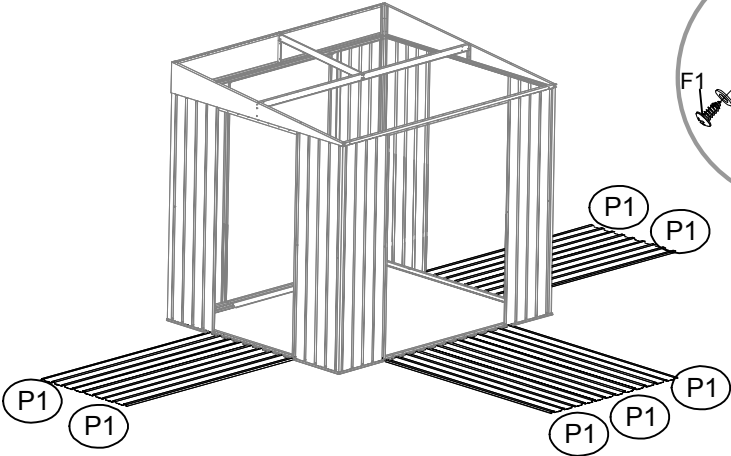







**23**

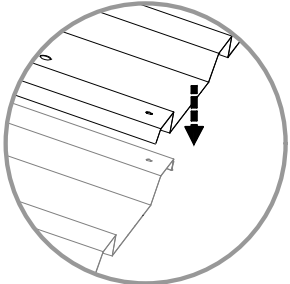

P2		2x
P3		3x
P4		1x



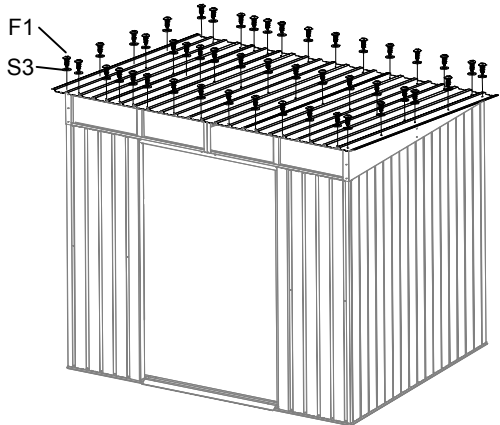



**24**



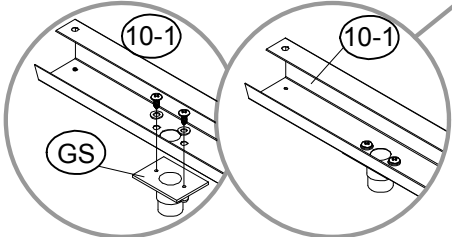

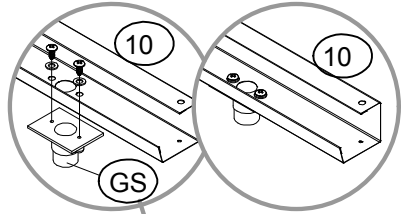
GS		2x
10		1x
10-1		1x

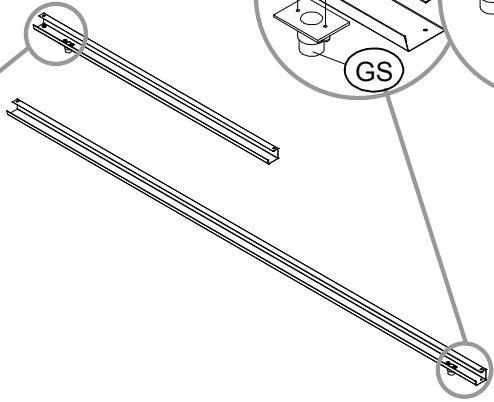





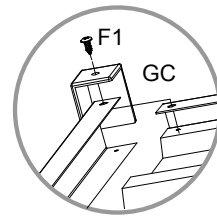
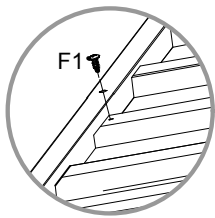
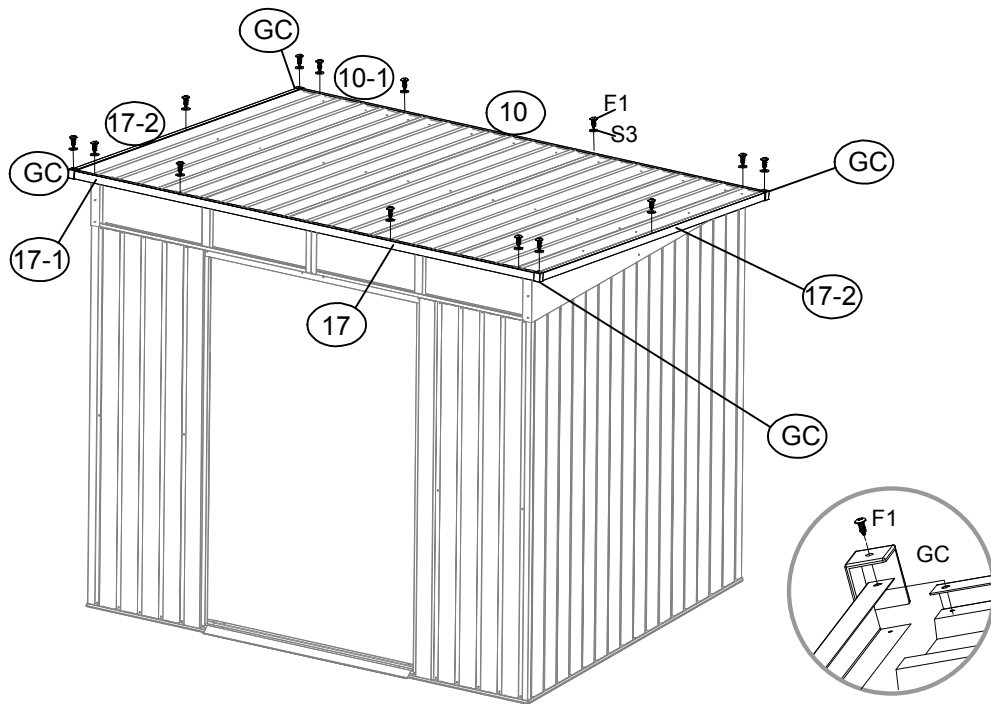

**25**

17-2		2x
17-1		1x
17		1x
GC		4x

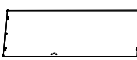
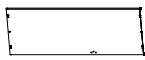

**26**

D1		1x
D2		1x
GB		2x

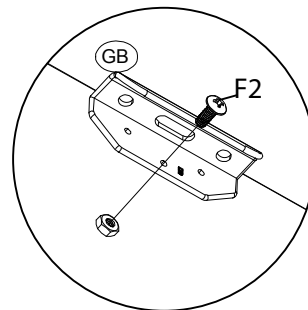
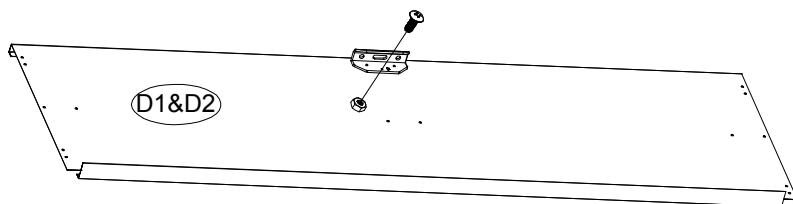

**27**

**x2**

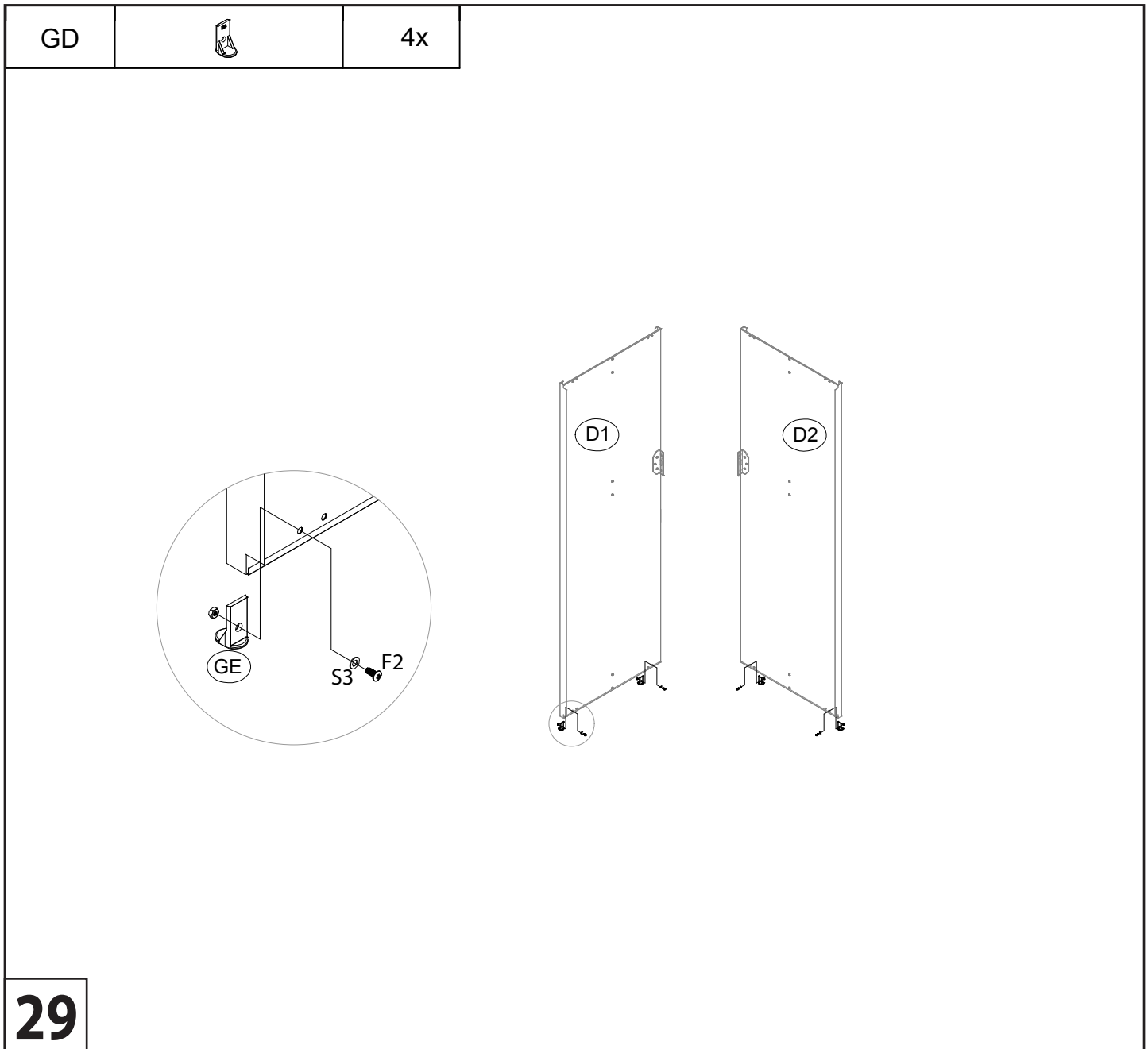
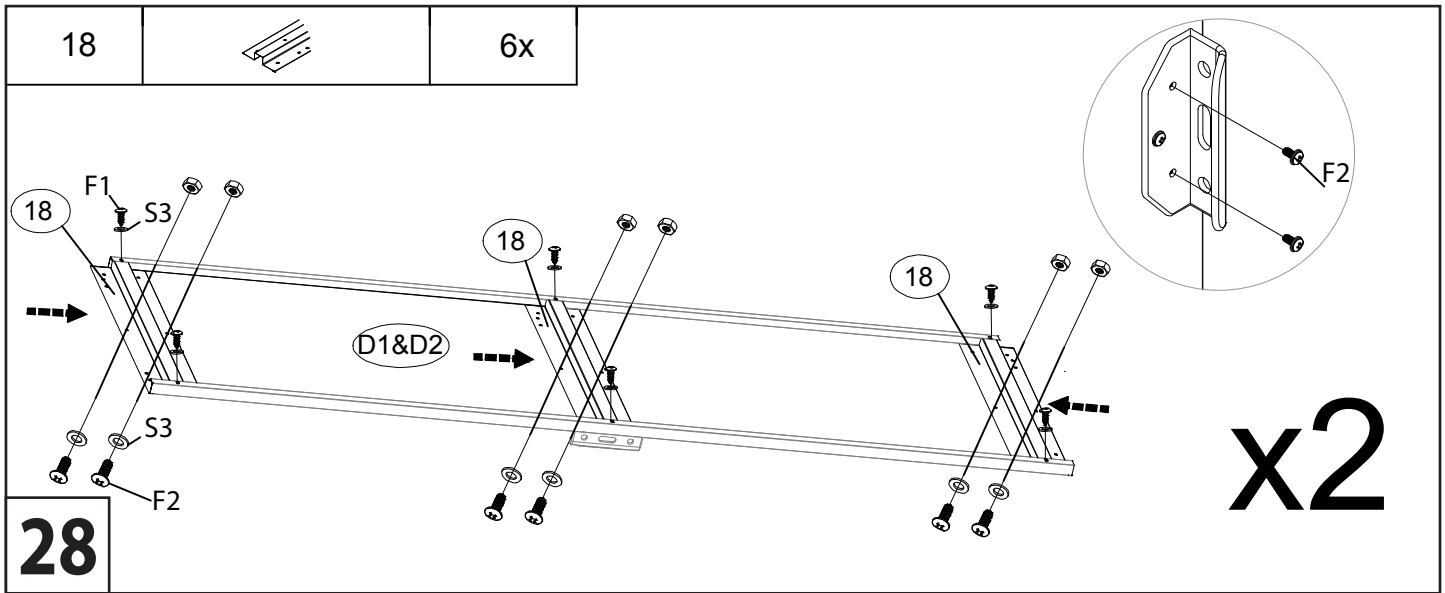

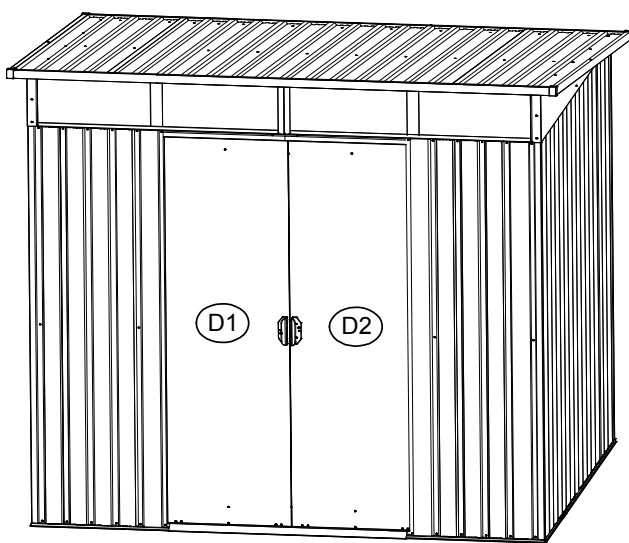
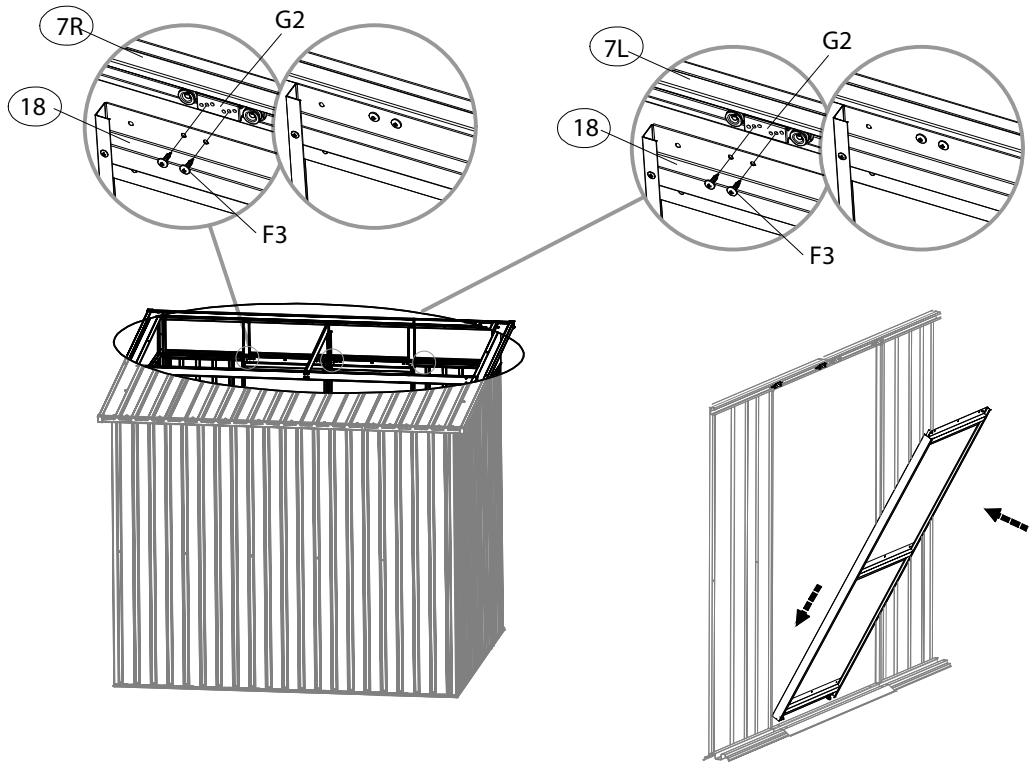

**30**

S2

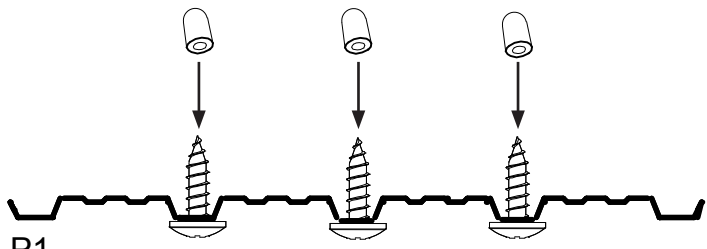

P1  
P2  
P3  
P4

**31**