

Achtung ! Gläser niemals ungeschützt auf den Boden stellen.
Verletzung der Glaskante führt zu Glasbruch.

Caution ! Never put glass walls on the floor without protection.
Damaging the glass edges results in breaking of the glass.

Attention ! Jamais plaçer des parois de douche en verre au sol sans
protéction. Des verres endommagés casseront.



Aug. 2020 / XC / 03/2021 KB

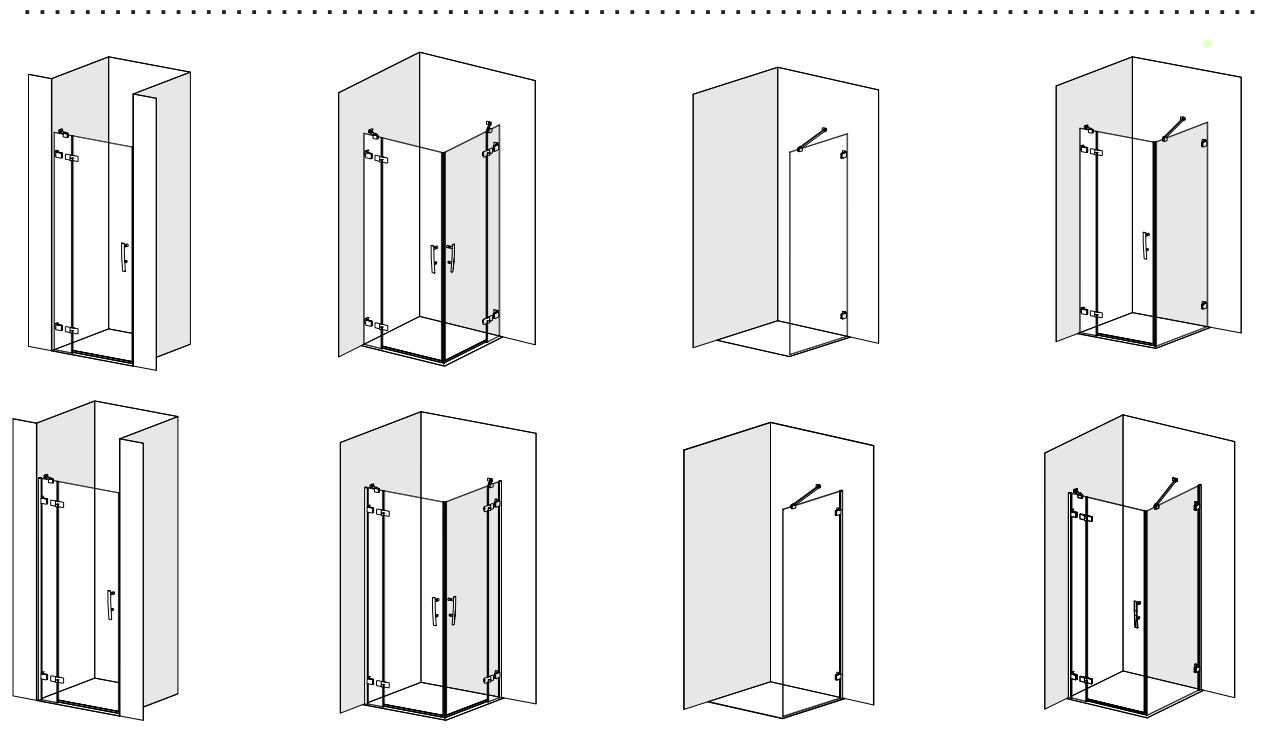



Achtung ! Gläser niemals ungeschützt auf den Boden stellen.
Verletzung der Glaskante führt zu Glasbruch.

Caution ! Never put glass walls on the floor without protection.
Damaging the glass edges results in breaking of the glass.

Attention ! Jamais plaquer des parois de douche en verre au sol sans protection. Des verres endommagés casseront.

Zum Aufbau benötigen Sie
for mounting you need
pour l'installation il vous faut

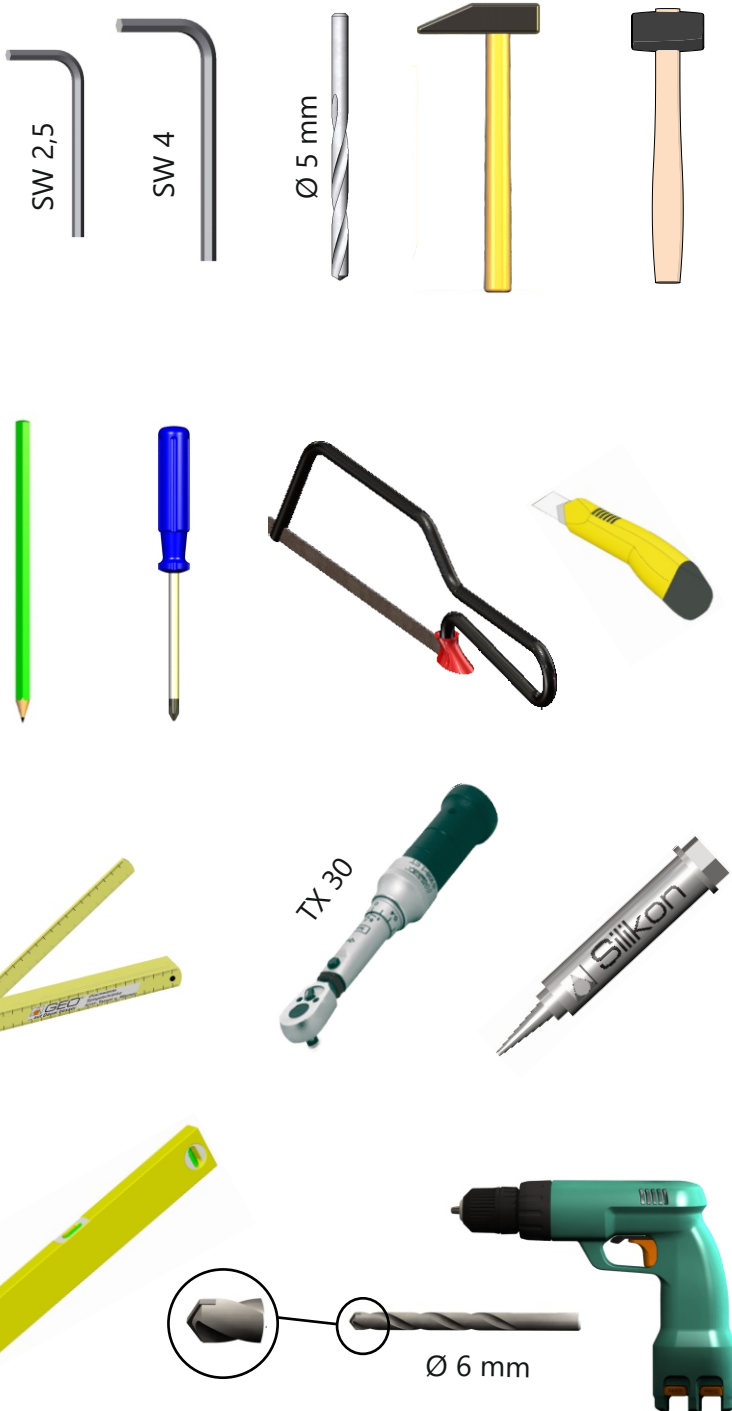

Mitgeliefertes Montagematerial
supplied assembly material
matériaux pour assemblage

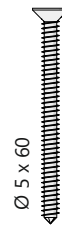

D = 6 x 36

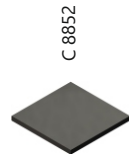

Ersatzteile finden Sie auf unserer Homepage:

As for spare parts see:

En matière pièces de rechange:

www.geoprodukte.com





Achtung ! Gläser niemals ungeschützt auf den Boden stellen.
Verletzung der Glaskante führt zu Glasbruch.

Caution ! Never put glass walls on the floor without protection.
Damaging the glass edges results in breaking of the glass.

Attention ! Jamais placer des parois de douche en verre au sol sans
protection. Des verres endommagés casseront.

EckEinstieg -- Seite 4-7
corner entry -- page 4-7
entrée d'angle -- page 4-7

C / B72L		C / B72R
C / B73L	+	C / B73R
C / B74L		C / B74R

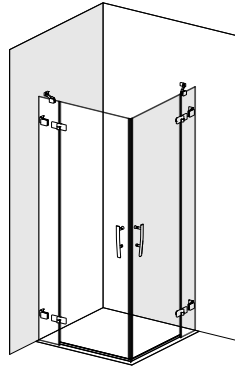

rahmenlos
frameless
sans profil

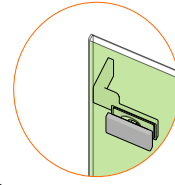

mit Profi
with profile
avec profil

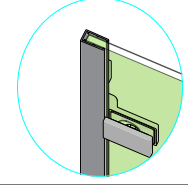

FrontEinstieg -- Seite 4-10
front entry -- page 4-10
entrée avant -- page 4-10

C / B72L		C / B76
C / B73L	+	C / B77
C / B74L		C / B78
		C / B80
		C / B81

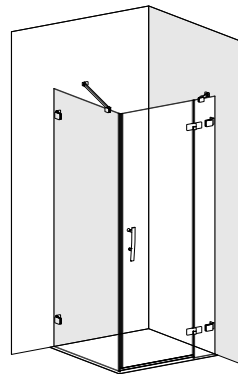
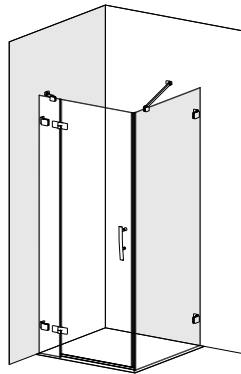

C/B76		C / B72R
C/B77	+	C / B73R
C/B78		C / B74R
C/B80		
C/B81		

Nische -- Seite 4-7 + 11
niche -- page 4-7 + 11
niche -- page 4-7 + 11

C / B72L		C / B29
C / B73L	+	
C / B74L		

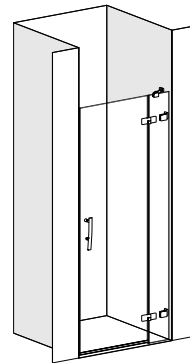
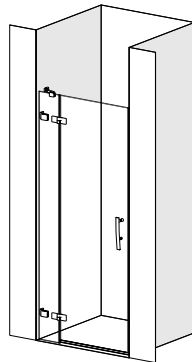

C / B29	+	C / B72R
		C / B73R
		C / B74R

Walk-In -- Seite 8-10
walk-in -- page 8-10
walk-in -- page 8-10

C / B76
C / B77
C / B78
C / B80
C / B81

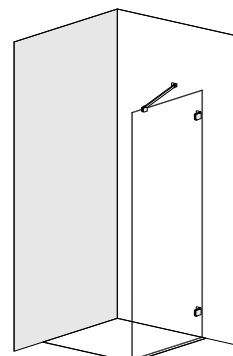
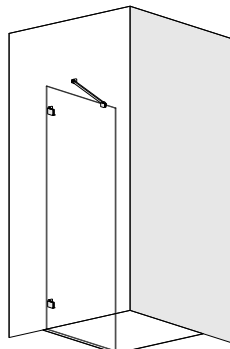

C / B76
C / B77
C / B78
C / B80
C / B81

Achtung ! Gläser niemals ungeschützt auf den Boden stellen.
Verletzung der Glaskante führt zu Glasbruch.

Caution ! Never put glass walls on the floor without protection.
Damaging the glass edges results in breaking of the glass.

Attention ! Jamais plaçer des parois de douche en verre au sol sans
protéction. Des verres endommagés casseront.



Festteil + Tür
fixed part + door
partie fixe + porte

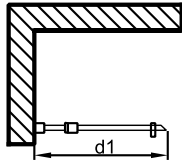

Modell	Elementmaß element dimension dimension de Élément d1 (mm)
C / B72L / R	770-772
C / B73L / R	870-872
C / B74L / R	970-972

Modell	Elementmaß element dimension dimension de Élément d1 (mm)
C / B72L / R	772-782
C / B73L / R	872-882
C / B74L / R	972-982

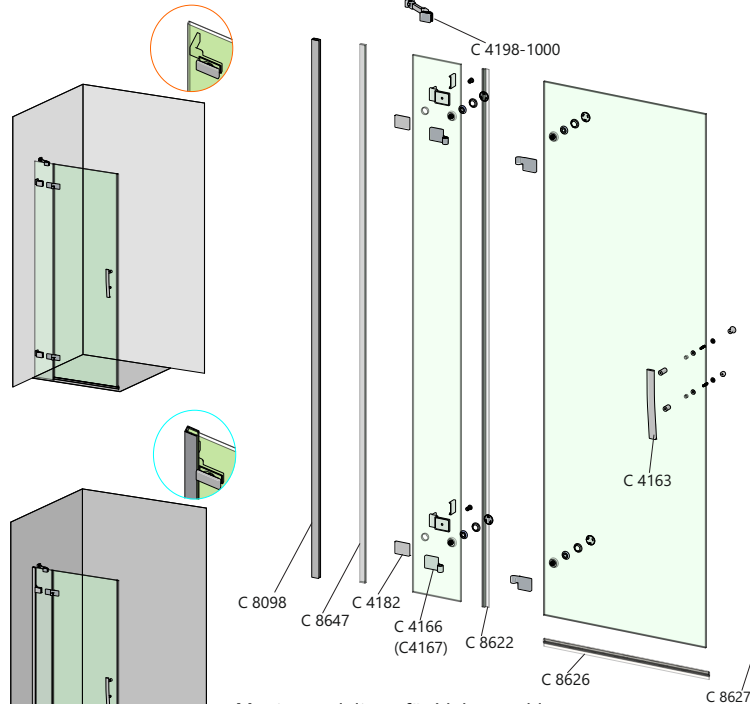

Mitteliefertes Montagmaterial
supplied assembly material
matériaux pour assemblage

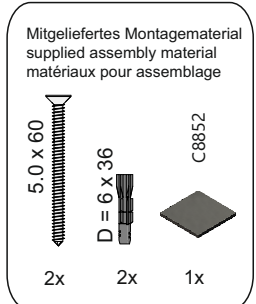

5.0 x 60
D = 6 x 36
C8852

2x 2x 1x

Montageanleitung für Linksanschlag
(Rechtsanschlag = spiegelbildlich)
Assembly instructions for left hand mounting
(right hand mounting = mirror inverted)
instruction d'assemblage pour charnière à gauche
(à droite = inversé latéralement)

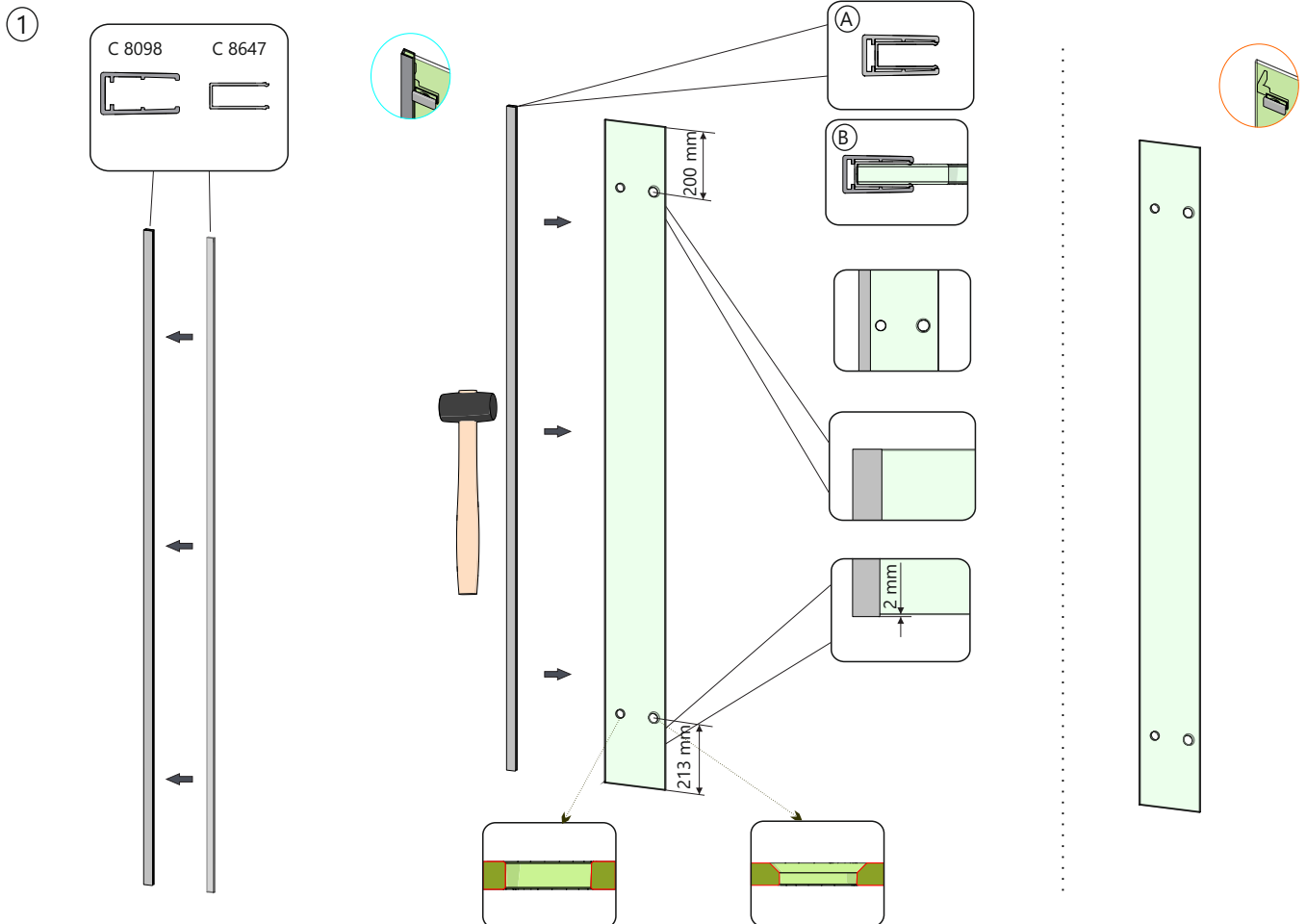



Achtung ! Gläser niemals ungeschützt auf den Boden stellen.
 Verletzung der Glaskante führt zu Glasbruch.
Caution ! Never put glass walls on the floor without protection.
 Damaging the glass edges results in breaking of the glass.
Attention ! Jamais placer des parois de douche en verre au sol sans
 protection. Des verres endommagés casseront.

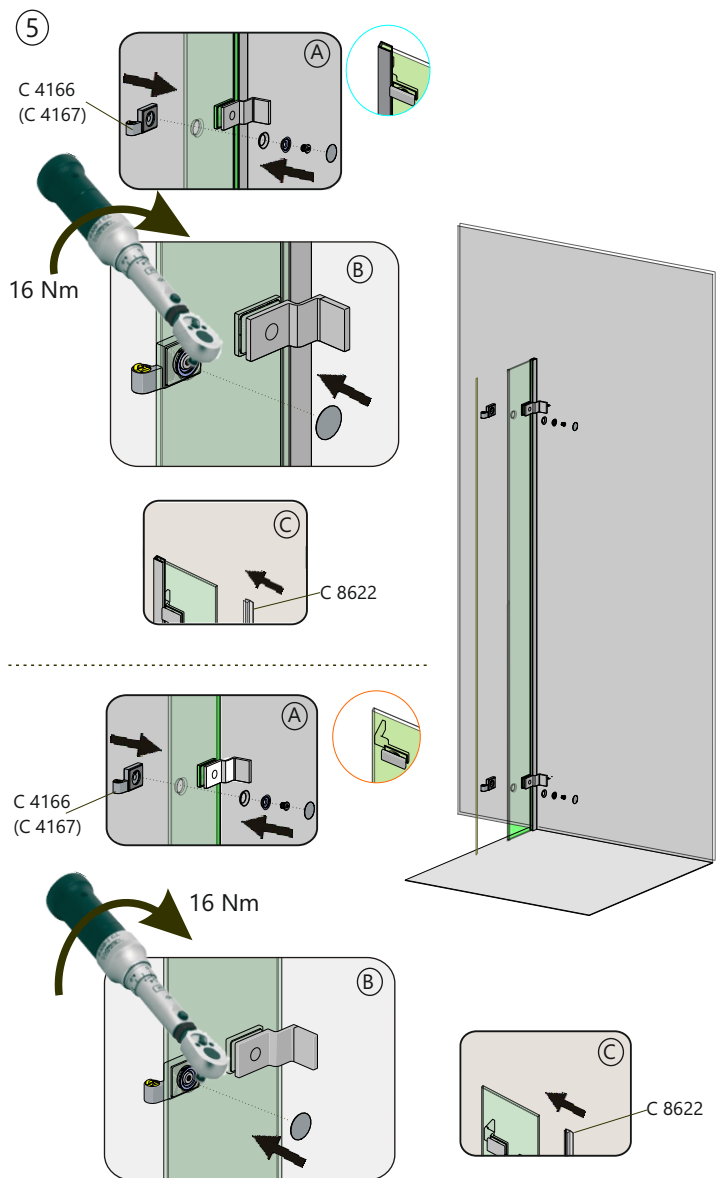
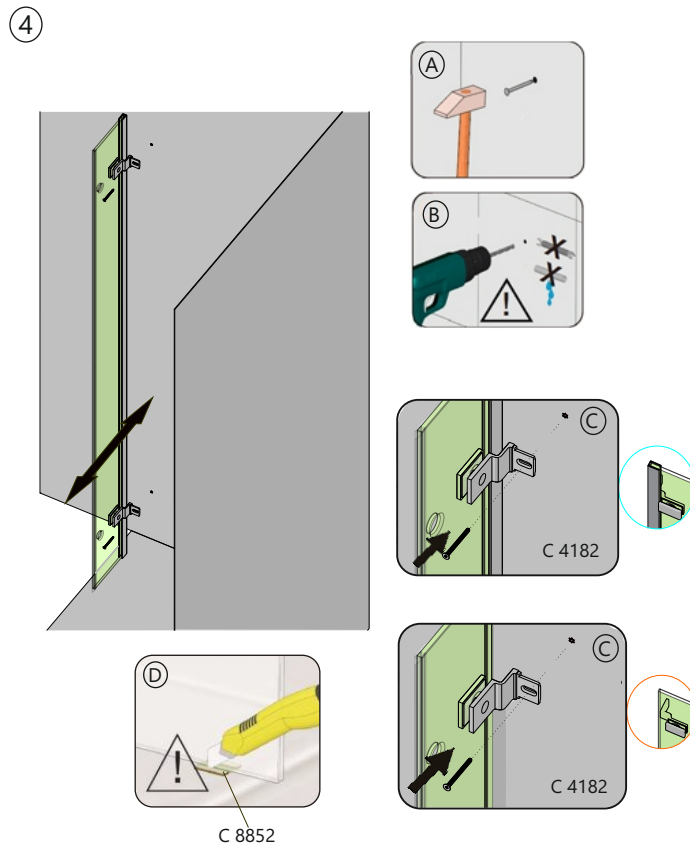
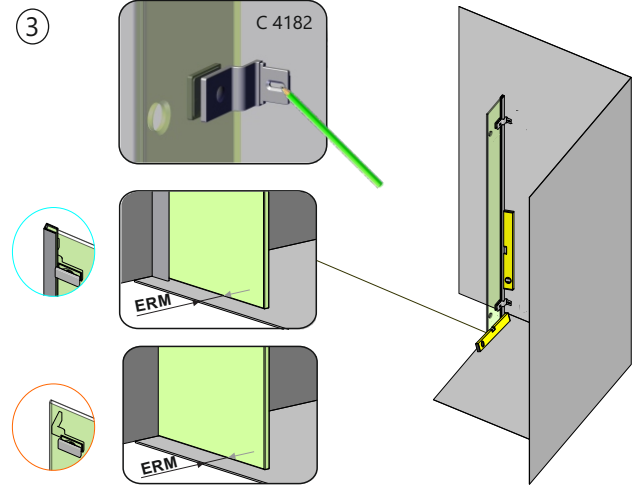
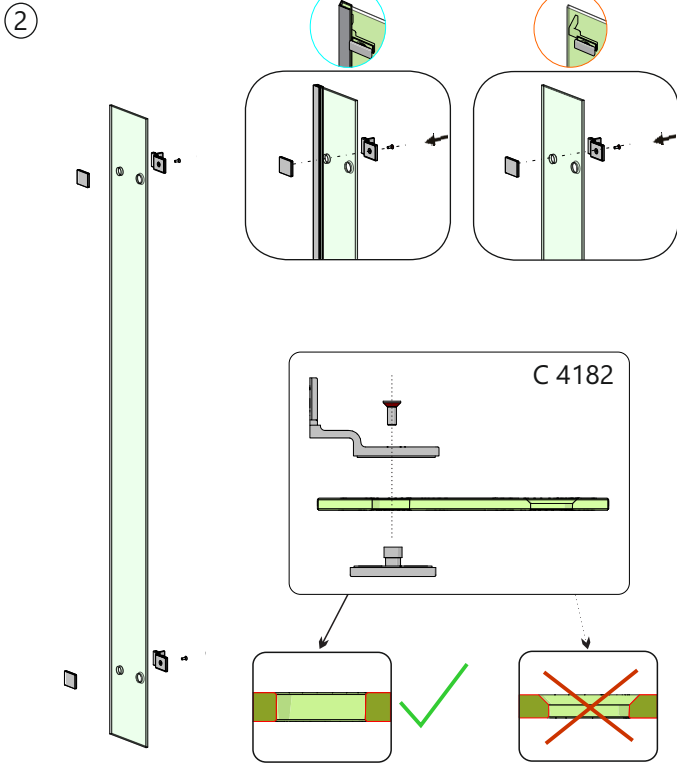



Achtung ! Gläser niemals ungeschützt auf den Boden stellen.
 Verletzung der Glaskante führt zu Glasbruch.

Caution ! Never put glass walls on the floor without protection.
 Damaging the glass edges results in breaking of the glass.

Attention ! Jamais placer des parois de douche en verre au sol sans
 protection. Des verres endommagés casseront.

6

! Magnetprofil G8627 nur unten kürzen.
 Magnet profile G8627 only shorten at bottom
 Profilé magnétique raccourcir au bout au-dessous seulement.

7

Tür / door / porte

Tür / door / porte

C 8623

C 8622

C8627 + C8627

C8627 + C8627

8

!

d1

A

B

C

D

C 4182

C 8098

5 - 15 mm

Achtung ! Gläser niemals ungeschützt auf den Boden stellen.
Verletzung der Glaskante führt zu Glasbruch.

Caution ! Never put glass walls on the floor without protection.
Damaging the glass edges results in breaking of the glass.

Attention ! Jamais placer des parois de douche en verre au sol sans
protéction. Des verres endommagés casseront.



9

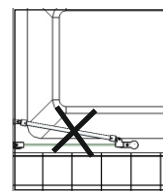
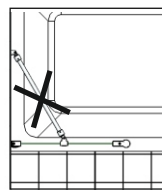
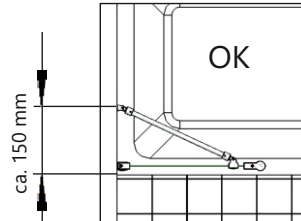
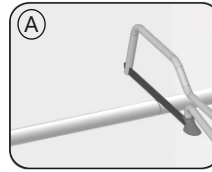
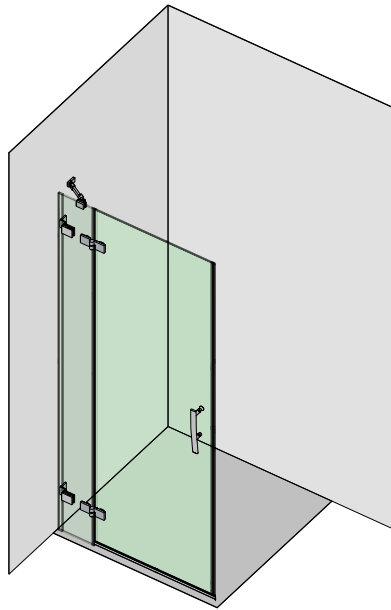

10

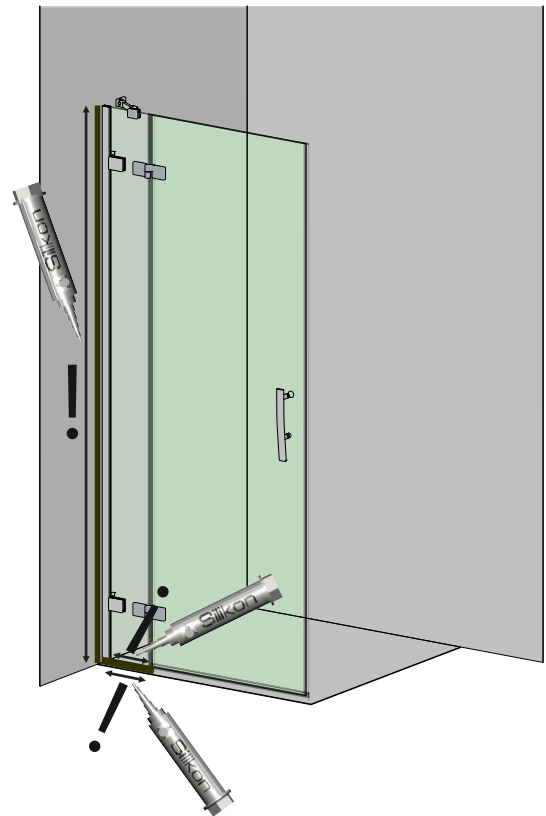
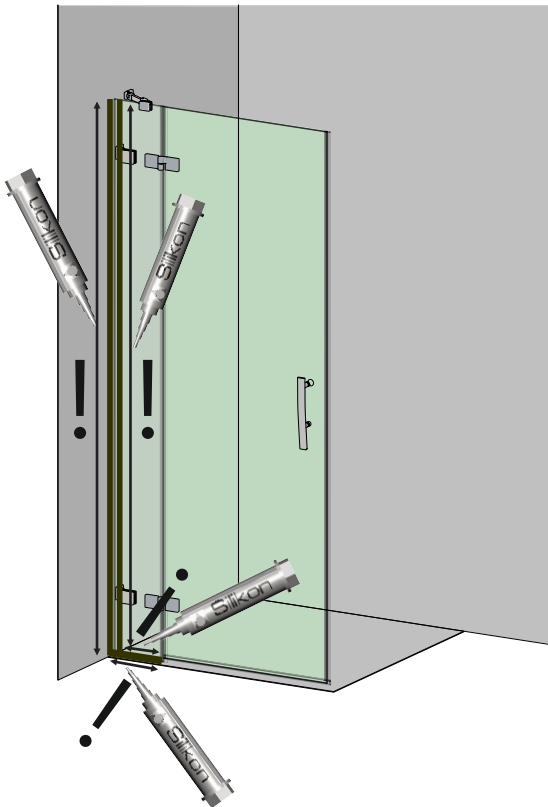
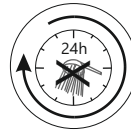



Achtung ! Gläser niemals ungeschützt auf den Boden stellen.
Verletzung der Glaskante führt zu Glasbruch.

Caution ! Never put glass walls on the floor without protection.
Damaging the glass edges results in breaking of the glass.

Attention ! Jamais plaquer des parois de douche en verre au sol sans protection. Des verres endommagés casseront.

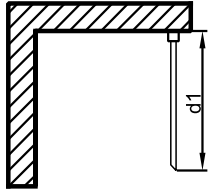
Seitenteil side panel panneau latéral	
	
Modell	Elementmaß Maße inkl. Magnetprofil element dimension dimensions incl. magnetic profile dimension de l'élément dimensions avec profil magnétique d1 (mm)
C / B76	770-772
C / B77	870-872
C / B78	970-972
C / B80	1170-1172
C / B81	1370-1372

Modell	Elementmaß Maße inkl. Magnetprofil element dimension dimensions incl. magnetic Profile dimension de l'élément dimensions avec profil magnétique d1 (mm)
C / B76	772-782
C / B77	872-882
C / B78	972-982
C / B80	1172-1182
C / B81	1372-1382

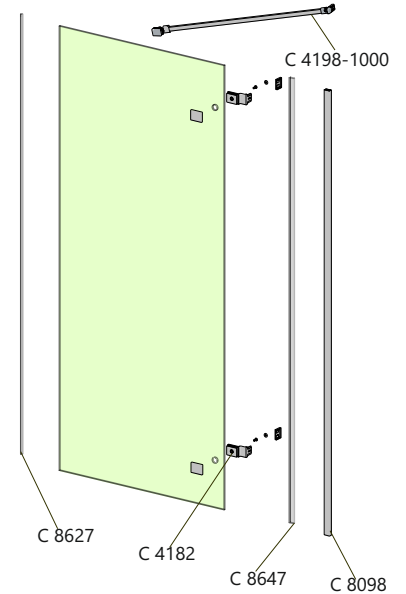
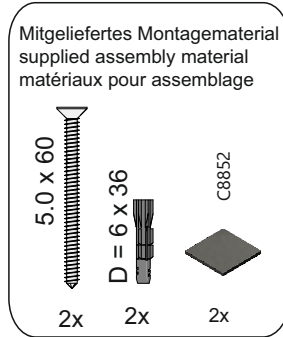
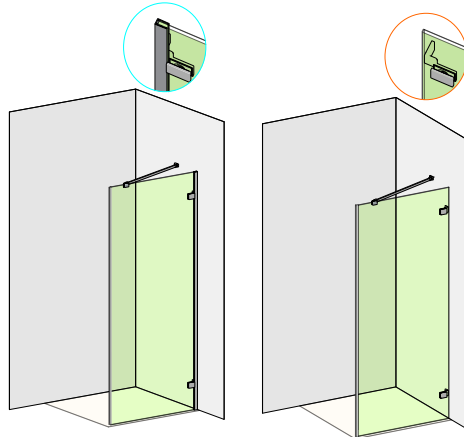

Montageanleitung für Rechtsanschlag
(Linksanschlag = spiegelbildlich)
Assembly instructions for right hand mounting
(left hand mounting = mirror inverted)
instruction d'assemblage pour charnière à droite
(à gauche = inversé latéralement)

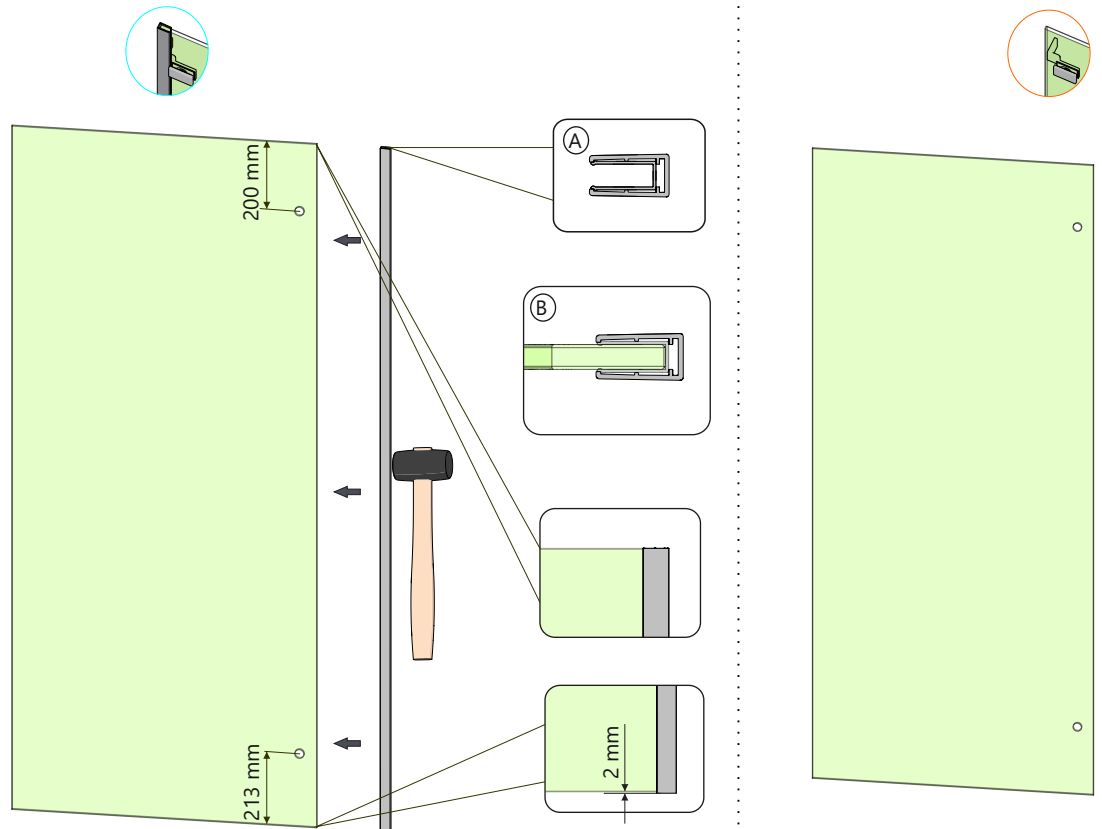
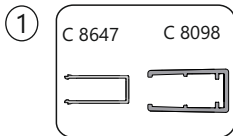

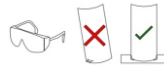

Achtung ! Gläser niemals ungeschützt auf den Boden stellen.
Verletzung der Glaskante führt zu Glasbruch.

Caution ! Never put glass walls on the floor without protection.
Damaging the glass edges results in breaking of the glass.

Attention ! Jamais plaçer des parois de douche en verre au sol sans
protection. Des verres endommagés casseront.

②

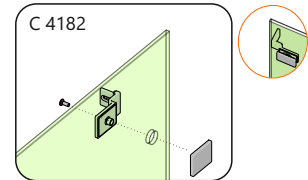
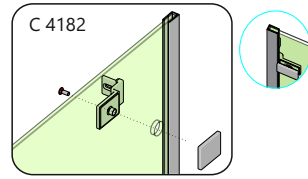
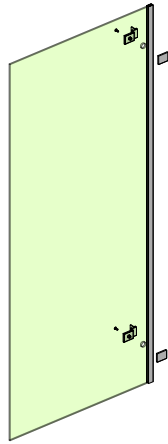

③

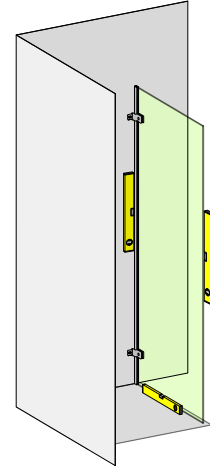
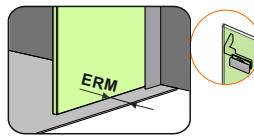
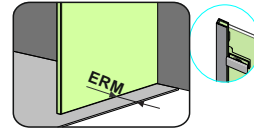
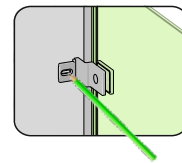

④

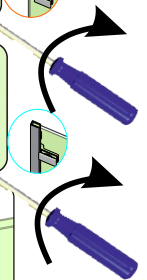
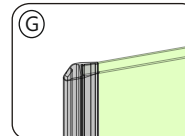
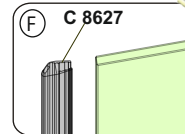
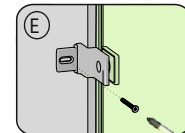
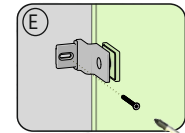
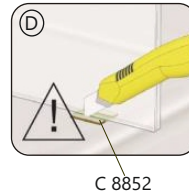
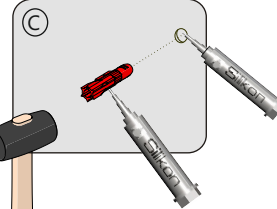
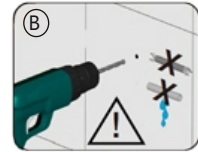
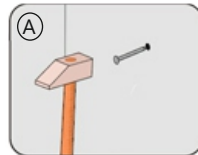
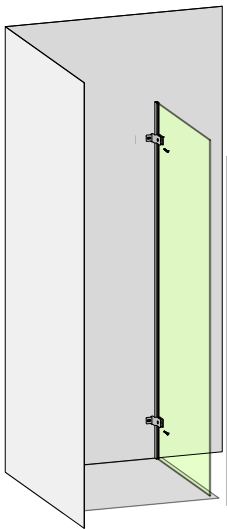

⑤

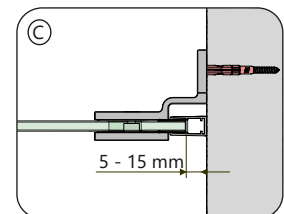
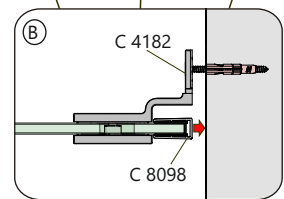
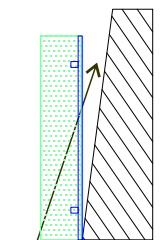
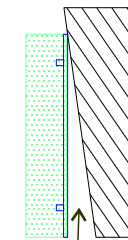
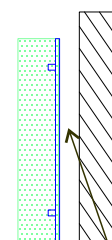
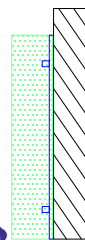
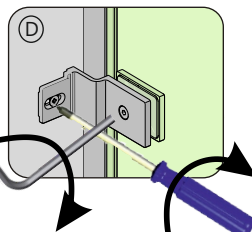
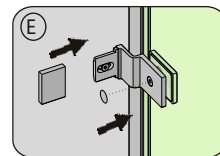
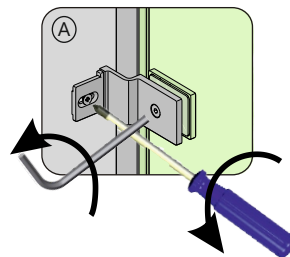
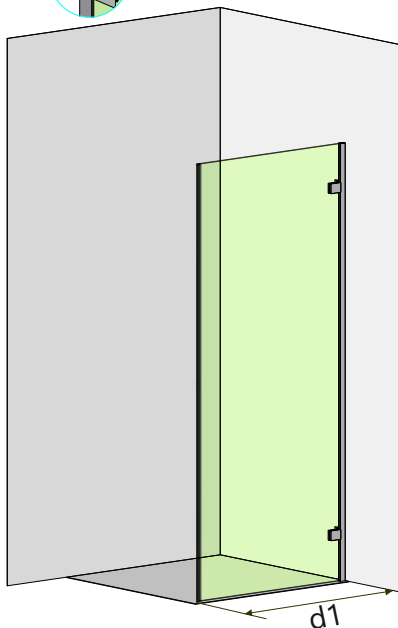



Achtung ! Gläser niemals ungeschützt auf den Boden stellen.
 Verletzung der Glaskante führt zu Glasbruch.
Caution ! Never put glass walls on the floor without protection.
 Damaging the glass edges results in breaking of the glass.
Attention ! Jamais plaçer des parois de douche en verre au sol sans
 protection. Des verres endommagés casseront.

⑥

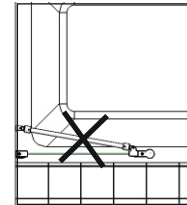
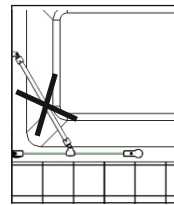
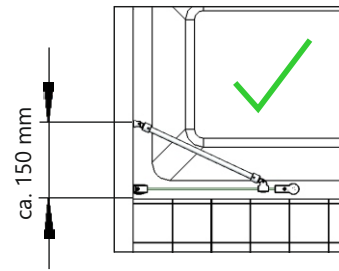
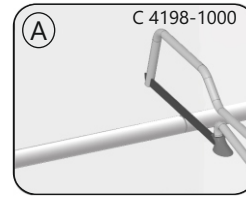
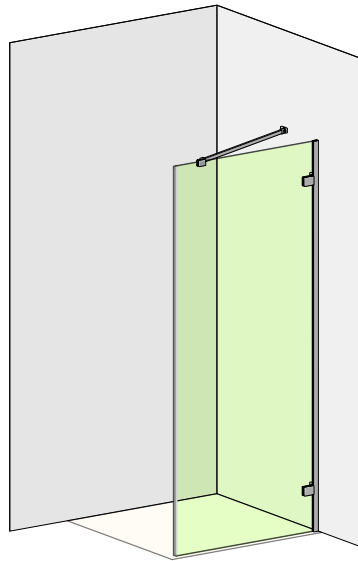

⑦

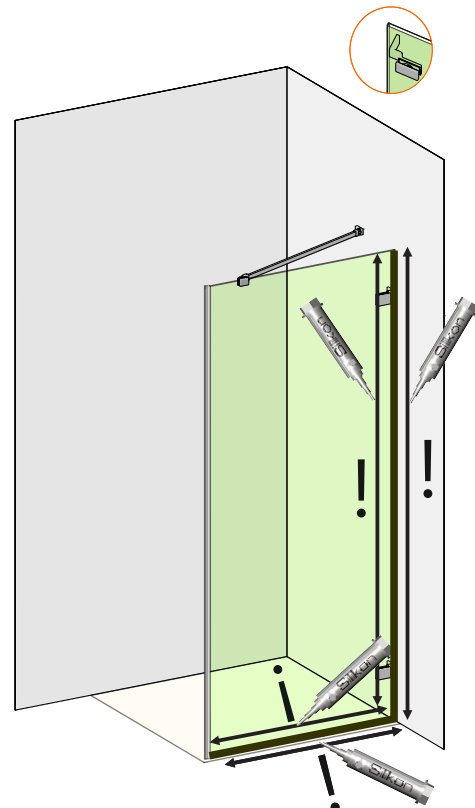
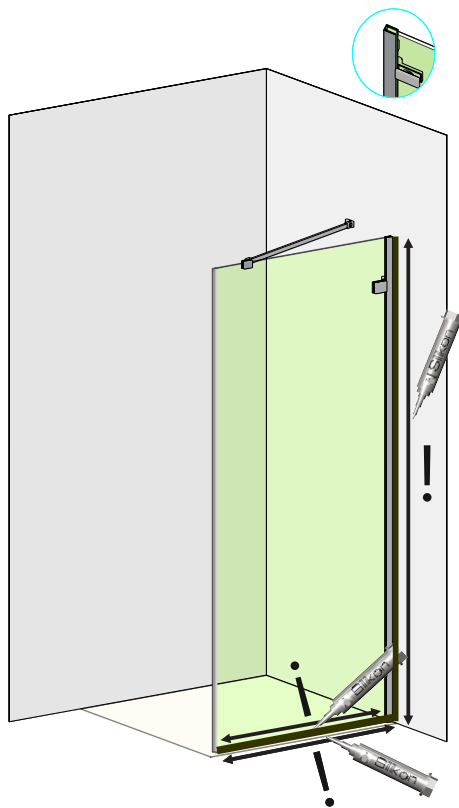

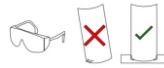

Achtung ! Gläser niemals ungeschützt auf den Boden stellen.
Verletzung der Glaskante führt zu Glasbruch.

Caution ! Never put glass walls on the floor without protection.
Damaging the glass edges results in breaking of the glass.

Attention ! Jamais plaçer des parois de douche en verre au sol sans
protection. Des verres endommagés casseront.

Festteil+Tür
Fixed part + door
Partie fixe + porte

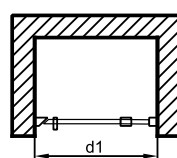

Modell	Elementmaß element dimension dimension de l'élément d1 (mm)
C / B72L / R + C / B29	781-791
C / B73L / R + C / B29	881-891
C / B74L / R + C / B29	981-991

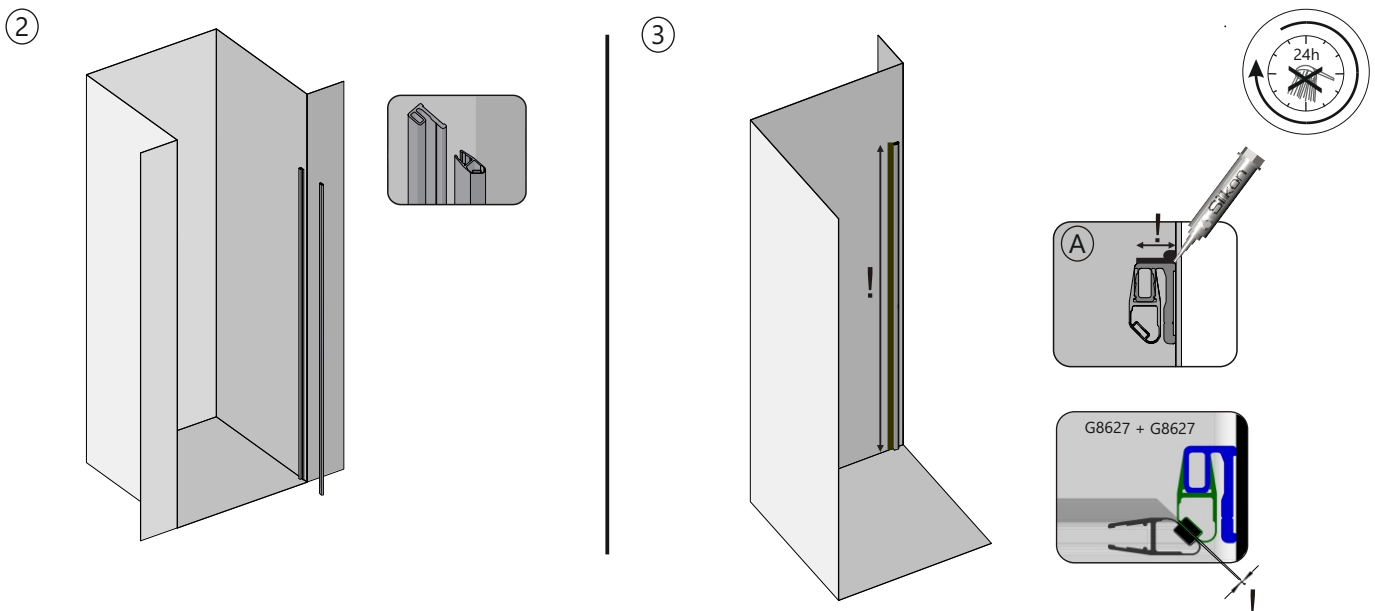
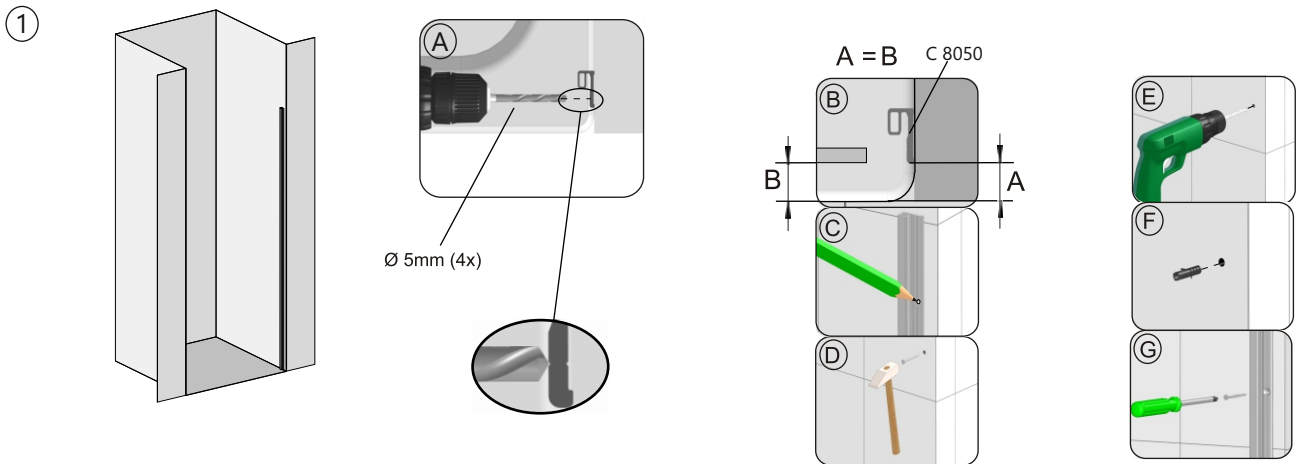
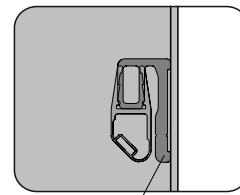
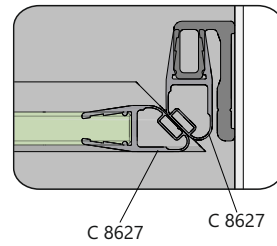
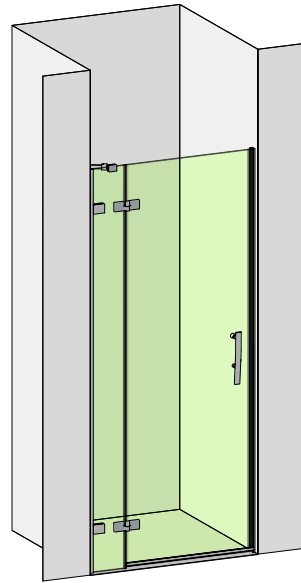



Achtung ! Gläser niemals ungeschützt auf den Boden stellen.
Verletzung der Glaskante führt zu Glasbruch.

Caution ! Never put glass walls on the floor without protection.
Damaging the glass edges results in breaking of the glass.

Attention ! Jamais placer des parois de douche en verre au sol sans protection. Des verres endommagés casseront.

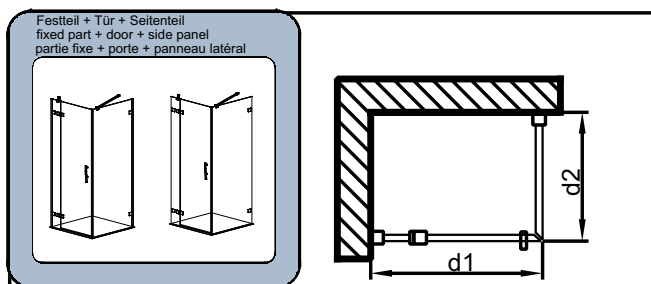

Modell	Duschasseneinbaumaß shower tray bases installation dimensions receveurs de douche dimension d'installation	Einrückmaß indent dimension dimension de retrait ERM	Elementmaß element dimension dimension de l'élément d1	Duschasse shower tray receveur de douche
C / B72L / R	785-787	15	770-772	800er 785 bis 802
C / B72L / R	790-792	20	770-772	
C / B72L / R	795-797	25	770-772	
C / B72L / R	800-802	30	770-772	
C / B73L / R	885-887	15	870-872	900er 885 bis 902
C / B73L / R	890-892	20	870-872	
C / B73L / R	895-897	25	870-872	
C / B73L / R	900-902	30	870-872	1000er 985 bis1002
C / B74L / R	985-987	15	970-972	
C / B74L / R	990-992	20	970-972	
C / B74L / R	995-997	25	970-972	
C / B74L / R	1000-1002	30	970-972	

Modell	Duschasseneinbaumaß shower tray bases installation dimensions receveurs de douche dimension d'installation	Einrückmaß indent dimension dimension de retrait ERM	Elementmaß element dimension dimension de l'élément d1	Duschasse shower tray receveur de douche
C / B72L / R	787-797	15	772-782	800er 787 bis 812
C / B72L / R	792-802	20	772-782	
C / B72L / R	797-807	25	772-782	
C / B72L / R	802-812	30	772-782	
C / B73L / R	887-897	15	872-882	900er 887 bis 912
C / B73L / R	892-902	20	872-882	
C / B73L / R	897-907	25	872-882	
C / B73L / R	902-912	30	872-882	1000er 987 bis1012
C / B74L / R	987-997	15	972-982	
C / B74L / R	992-1002	20	972-982	
C / B74L / R	997-1007	25	972-982	
C / B74L / R	1002-1012	30	972-982	

Modell	Duschasseneinbaumaß shower tray bases installation dimensions receveurs de douche dimension d'installation	Einrückmaß indent dimension dimension de retrait ERM	Elementmaß element dimension dimension de l'élément d2	Duschasse shower tray receveur de douche
C / B76	785-787	15	770-772	800er 785 bis 802
C / B76	790-792	20	770-772	
C / B76	795-797	25	770-772	
C / B76	800-802	30	770-772	
C / B77	885-887	15	870-872	900er 885 bis 902
C / B77	890-892	20	870-872	
C / B77	895-897	25	870-872	
C / B77	900-902	30	870-872	1000er 985 bis1002
C / B78	985-987	15	970-972	
C / B78	990-992	20	970-972	
C / B78	995-997	25	970-972	
C / B78	1000-1002	30	970-972	1200er 1185 bis1202
C / B80	1185-1187	15	1170-1172	
C / B80	1190-1192	20	1170-1172	
C / B80	1195-1197	25	1170-1172	1400er 1385 bis1402
C / B80	1200-1202	30	1170-1172	
C / B81	1385-1387	15	1370-1372	
C / B81	1390-1392	20	1370-1372	
C / B81	1395-1397	25	1370-1372	1400er 1385 bis1402
C / B81	1400-1402	30	1370-1372	

Modell	Duschasseneinbaumaß shower tray bases installation dimensions receveurs de douche dimension d'installation	Einrückmaß indent dimension dimension de retrait ERM	Elementmaß element dimension dimension de l'élément d2	Duschasse shower tray receveur de douche
C / B76	787-797	15	772-782	800er 787 bis 812
C / B76	792-802	20	772-782	
C / B76	797-807	25	772-782	
C / B76	802-812	30	772-782	900er 887 bis 912
C / B77	887-897	15	872-882	
C / B77	892-902	20	872-882	
C / B77	897-907	25	872-882	
C / B77	902-912	30	872-882	1000er 987 bis1012
C / B78	987-997	15	972-982	
C / B78	992-1002	20	972-982	
C / B78	997-1007	25	972-982	
C / B78	1002-1012	30	972-982	1200er 1187 bis1212
C / B80	1187-1197	15	1172-1182	
C / B80	1192-1202	20	1172-1182	
C / B80	1197-1207	25	1172-1182	
C / B80	1202-1212	30	1172-1182	1400er 1387 bis1412
C / B81	1387-1397	15	1372-1382	
C / B81	1392-1402	20	1372-1382	
C / B81	1397-1407	25	1372-1382	
C / B81	1402-1412	30	1372-1382	



Achtung ! Gläser niemals ungeschützt auf den Boden stellen.
Verletzung der Glaskante führt zu Glasbruch.

Caution ! Never put glass walls on the floor without protection.
Damaging the glass edges results in breaking of the glass.

Attention ! Jamais placer des parois de douche en verre au sol sans protection. Des verres endommagés casseront.

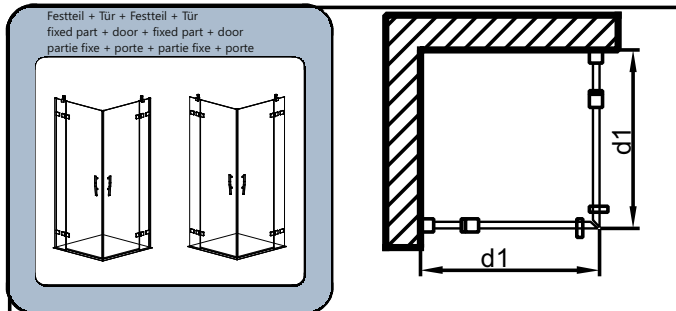

Modell	Duschasseneinbaumaß shower tray bases installation dimensions receveurs de douche dimension d'installation	Einrückmaß indent dimension dimension de retrait ERM	Elementmaß élément dimension dimension de l'élément d1	Duschtrasse shower tray receveur de douche
C / B72L / R	785-787	15	770-772	800er 785 bis 802
C / B72L / R	790-792	20	770-772	
C / B72L / R	795-797	25	770-772	
C / B72L / R	800-802	30	770-772	
C / B73L / R	885-887	15	870-872	900er 885 bis 902
C / B73L / R	890-892	20	870-872	
C / B73L / R	895-897	25	870-872	
C / B73L / R	900-902	30	870-872	1000er 985 bis 1002
C / B74L / R	985-987	15	970-972	
C / B74L / R	990-992	20	970-972	
C / B74L / R	995-997	25	970-972	
C / B74L / R	1000-1002	30	970-972	

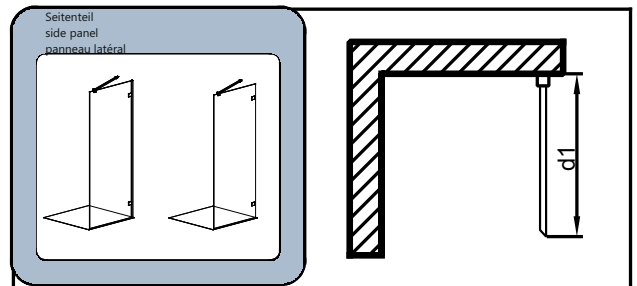

Modell	Elementmaß Maße ohne Magnetprofil element dimension dimensions without magnetic profile dimension de l'élément dimensions sans profil magnétique d1	Duschtrasse shower tray receveur de douche
C / B76	754-756	800er 785 bis 802
C / B77	854-856	
C / B78	954-956	
C / B80	1154-1156	
C / B81	1354-1356	

Modell	Duschasseneinbaumaß shower tray bases installation dimensions receveurs de douche dimension d'installation	Einrückmaß indent dimension dimension de retrait ERM	Elementmaß élément dimension dimension de l'élément d1	Duschtrasse shower tray receveur de douche
C / B72L / R	787-797	15	772-782	800er 787 bis 812
C / B72L / R	792-802	20	772-782	
C / B72L / R	797-807	25	772-782	
C / B72L / R	802-812	30	772-782	
C / B73L / R	887-897	15	872-882	900er 887 bis 912
C / B73L / R	892-902	20	872-882	
C / B73L / R	897-907	25	872-882	
C / B73L / R	902-912	30	872-882	1000er 987 bis 1012
C / B74L / R	987-997	15	972-982	
C / B74L / R	992-1002	20	972-982	
C / B74L / R	997-1007	25	972-982	
C / B74L / R	1002-1012	30	972-982	

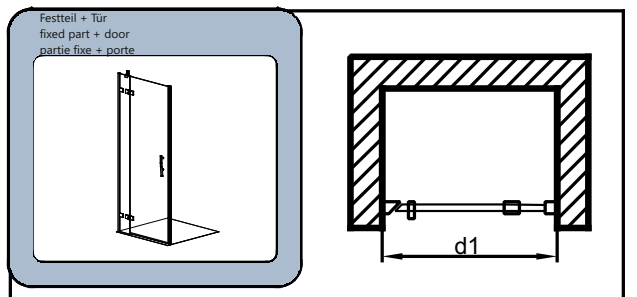

Modell	Elementmaß élément dimension dimension de l'élément d1
C / B72L / R + C / B29	781-791
C / B73L / R + C / B29	881-891
C / B74L / R + C / B29	981-991