





	W	6W	<h1>826893</h1>	
	Im	500 Lumen		<h2>230V/50Hz</h2>
	LED	1 x LED-Board max 13.5V/6W		
 LED  Im 500 Lumen  t 25.000h  T _k 3000 Kelvin  12.500 x  0s 				



Bitte geben Sie bei technischen Fragen die Chargennummer (xxxx-xx-xx-xxxx-xxx) an. Diese finden Sie auf dem Typenschild.

Please let us know the batch number (xxxx-xx-xx-xxxx-xxx) for any technical questions. This can be found on the rating plate.

Lors de demande d'assistance technique, veuillez indiquer le numéro du lot (xxxx-xx-xx-xxxx-xxx). Celui-ci se trouve sur la plaque d'identification.

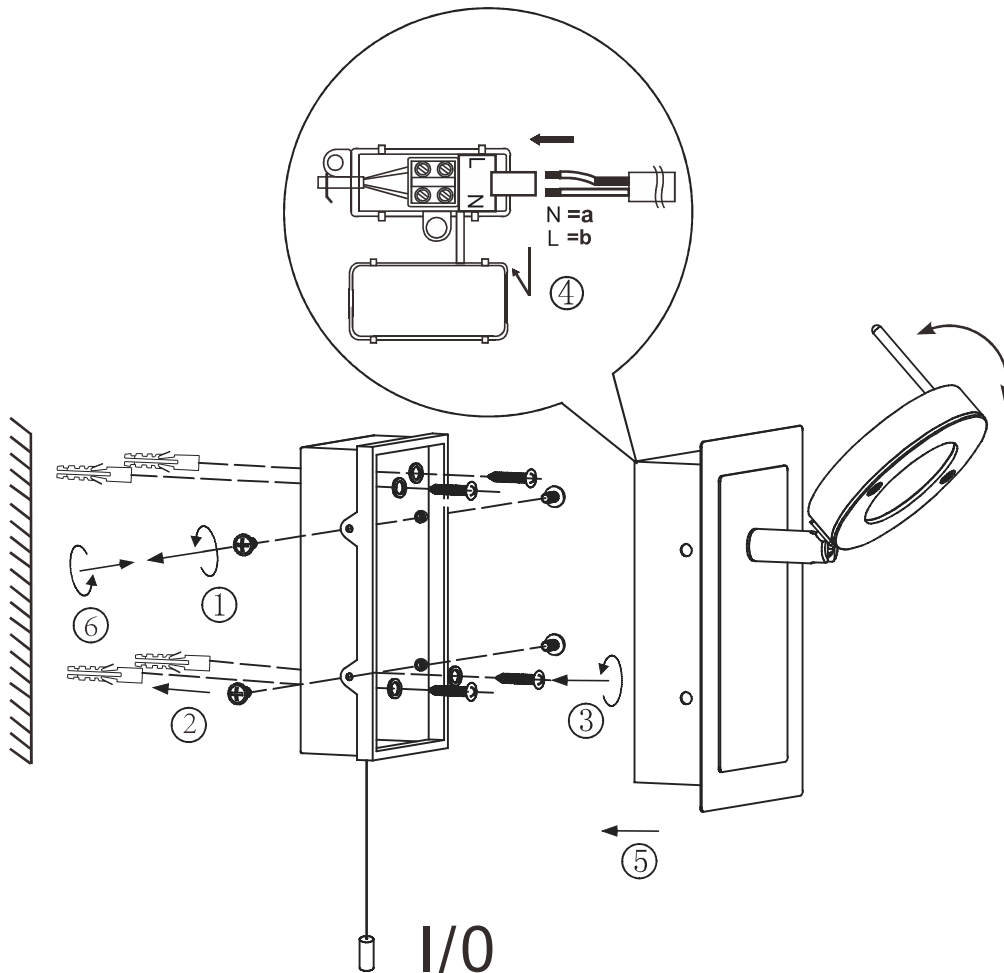
04/2017

Paul Neuhaus

 Neuhaus Lighting Group

Paul Neuhaus GmbH
 Olakenweg 36 • 59457 Werl
 Germany

D

Die Lichtquelle dieser Leuchte ist nicht ersetzbar; wenn die Lichtquelle ihr Lebensdauerende erreicht hat, ist die gesamte Leuchte zu ersetzen.

CZ

Světelný zdroj tohoto svítidla nelze vyměnit. Jakmile světelný zdroj dosáhne konce své životnosti, je nutné vyměnit celé svítidlo.

ES

La fuente luminosa de esta lámpara no es sustituible; cuando la fuente luminosa haya alcanzado el final de su vida útil, deberá sustituirse la lámpara completa.

F

La source de lumière de cette lampe n'est pas remplaçable ; une fois qu'elle a atteint la fin de sa durée de vie, c'est la lampe entière qui doit être remplacée.

GB

The light source of this luminaire is not replaceable; if the light source has reached the end of its service life, the entire luminaire should be replaced.

HR

Svjetlilo ove svjetiljke se ne može zamijeniti; kada svjetlilo dostigne kraj svoga vijeka trajanja, mora se zamijeniti cijela svjetiljka.

HU

A lámpában található fényforrás nem cserélhető; amikor a fényforrás élettartama a végére ér, a komplett lámpát ki kell cserélni.

IT

La lampadina di questa lampada non è sostituibile; una volta che la lampadina ha raggiunto la sua durata utile massima, sarà necessario cambiare la lampada intera.

NL

De lichtbron van deze lamp kan niet worden vervangen, als de lichtbron aan het einde van haar levensduur is gekomen, dient de complete lamp te worden vervangen.

PL

Źródło światła tej lampy nie jest możliwe do wymiany w przypadku, gdy źródło światła osiągnęło koniec żywotności. W takim przypadku należy wymienić całą lampę.

RO

Sursa de lumină a acestor lămpi nu este înlocuibilă; dacă sursa de lumină a ajuns la sfârșitul duratei de funcționare, trebuie să înlocuiți întreaga lampă.

RU

Источник света в данном светильнике не подлежит замене; по истечении срока службы источника света следует полностью заменить светильник.

SK

Svetelný zdroj tohto svietidla nie je možné vymeniť. Keď dosiahne svetelný zdroj koniec svojej životnosti, je potrebné vymeniť celé svietidlo.

TR

Bu lambanın ışık kaynağı değiştirilemez; ışık kaynağı kullanım ömrünü doldurduğunda, tüm lamba değiştirilmelidir