



# CERAMIC AC 1000/1500/1800

MANUAL de USUARIO

RADIADOR CERÁMICO WIFI

USER MANUAL

WIFI CERAMIC RADIATOR

MANUEL de L'UTILISATEUR

RADIATEUR CÉRAMIQUE WIFI

MANUAL DO USUÁRIO

RADIADOR CERÂMICO WIFI

MANUALE per L'UTENTE

RADIATORE CERAMICO WIFI

BETRIEBSANLEITUNG

WIFI-KERAMIK-HEIZKÖRPER



Lea estas instrucciones detenidamente antes del uso,  
y guárdelas para futuras consultas

## ESPECIFICACIONES

Modelo	Voltaje	Frecuencia	Potencia	Clase
CERAMIC AC 1000	230V~	50 Hz	1000W	II
CERAMIC AC 1500	230V~	50 Hz	1500W	II
CERAMIC AC 1800	230V~	50 Hz	1800W	II

## ADVERTENCIAS DE SEGURIDAD



**ATENCIÓN:** Algunas partes de este producto pueden calentarse y provocar quemaduras. Se debe prestar especial atención en presencia de niños y de personas vulnerables.



**ADVERTENCIA:** A fin de evitar un sobrecalentamiento, no cubrir el aparato.

- Los niños menores de 3 años deben mantenerse fuera del alcance del aparato a menos que sean continuamente supervisados
- Los niños desde 3 años y menores de 8 años deben sólo encender/apagar el aparato, siempre que este haya sido colocado o instalado en su posición de funcionamiento normal prevista y que sean supervisados o hayan recibido instrucciones relativas al uso del aparato de una forma segura y entiendan los riesgos que el aparato tiene. Los niños desde 3 años y menos de 8 años, no deben enchufar, regular y limpiar el aparato o realizar operaciones de mantenimiento.
- Este aparato pueden usarlo niños con edad de 8 años y superior y personas con capacidades físicas, sensoriales o mentales reducidas o falta de experiencia y conocimiento, si se les ha dado la supervisión o formación apropiadas respecto al uso del aparato de una manera segura y comprenden los peligros que implica. Los niños no deben jugar con el aparato. La limpieza y mantenimiento a realizar por el usuario no deben realizarlos los niños sin supervisión.
- Asegúrese de que el voltaje es el mismo que el indicado en la placa de características del aparato.
- Para evitar el riesgo de descarga eléctrica, asegúrese de que el aparato esté desenchufado de la toma de corriente antes de su traslado, mantenimiento o limpieza.
- No usar el aparato si el cable está dañado.

- Mantener este aparato y su cable alejados de fuentes de calor, objetos punzantes o cualquier cosa que pueda dañarlo.
- Asegúrese de que el aparato esté apagado antes de conectarlo a la red eléctrica.
- Si el cable eléctrico está dañado, debe ser reemplazado por el fabricante, un agente del servicio técnico o personas cualificadas a fin de evitar cualquier peligro.
- El aparato no debe ser instalado justo debajo de una toma de corriente.
- Colocar siempre el aparato en una superficie estable y nivelada y usar en posición vertical.
- No usar el aparato en zonas donde se pueda utilizar o almacenar gasolina, pintura u otros líquidos inflamables.
- Sólo para uso en interiores.
- Para evitar un incendio, no bloquee la entrada y salida de aire de ninguna manera.
- No toque las superficies calientes.
- No introduzca ni permita que entren objetos extraños en ninguna abertura de ventilación, para evitar descargas eléctricas o incendios.
- Asegúrese siempre de tener las manos secas antes de tocar el aparato.
- La causa principal del sobrecalentamiento se debe a los depósitos de polvo o residuos en la aparato. Asegúrese de que estos cuerpos extraños se retiren regularmente. Desenchufe el aparato de la red y límpiela aspirando la entrada de aire y las rejillas.
- El aparato debe instalarse de tal forma que los interruptores y otros controles no puedan ser tocados por nadie en la bañera o la ducha.
- No usar el aparato con un temporizador, un sistema de control remoto separado o cualquier otro dispositivo que encienda automáticamente la unidad, ya que existe el riesgo de incendio si la unidad se cubre o se coloca incorrectamente.
- Al instalar el radiador en su soporte, asegúrese de que el cable eléctrico no entre en contacto con la carcasa metálica del radiador.
- El aparato debe suministrarse a través de un diferencial de corriente residual (DCR) cuya corriente residual nominal de funcionamiento sea inferior a 30 mA.
- Se deben incorporar los medios de desconexión con una separación de contacto en todos los polos en el cableado fijo de acuerdo con las normas de cableado.
- **PRECAUCIÓN:** Con el fin de evitar riesgos relacionados con la activación inoportuna del interruptor térmico, este aparato no debe ser alimentado a través de un dispositivo de conmutación externo, como un temporizador, ni estar conectado a un circuito que encienda y apague regularmente el aparato.

## INSTALACIÓN

El aparato sólo debe utilizarse e instalarse en una posición fija.

La instalación debe ser realizada por un electricista cualificado para evitar cualquier peligro.

- **IMPORTANTE!** Asegúrese de que no haya cables eléctricos u otras instalaciones (por ejemplo, tuberías de agua) cerca de los lugares donde se van a realizar los agujeros. Asegúrese de fijar la unidad verticalmente y firmemente a la pared.
- Este aparato está diseñado para su instalación y uso en interiores.
- El aparato no debe colocarse directamente debajo de una toma de corriente.
- Respete las distancias mínimas entre el aparato y las paredes, el suelo, los muebles, las cortinas, etc.

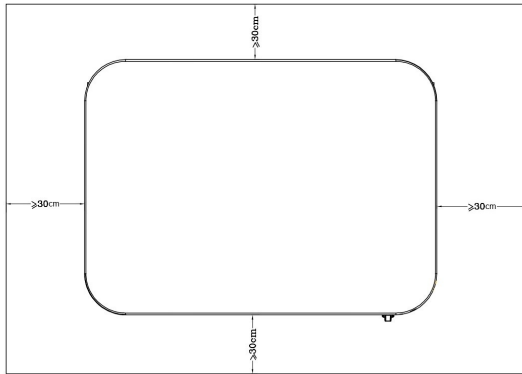

1. Asegúrese de mantener la distancia entre el calentador y el suelo, la pared y demás al menos 30 cm.
2. No usar en el baño y no cubrir.
3. Taladrar los dos agujeros superiores ( $\varnothing 8$ ) en la pared e insertar los tornillos de expansión en los agujeros.

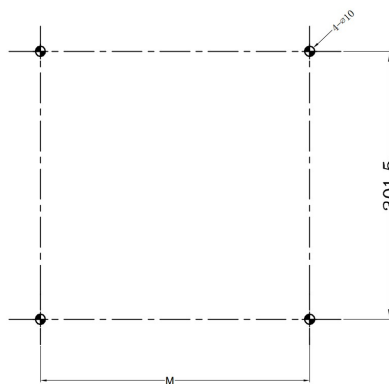

Modelo	Ceramic AC 1000	Ceramic AC 1500	Ceramic AC 1800
M (mm)	228	378	378



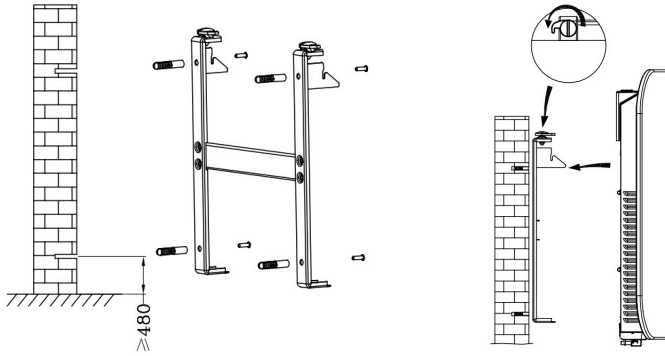

4. Los ganchos están pre-montados en la parte trasera del calentador, colgar los dos ganchos superiores en los tornillos. Marcar la posición de los dos ganchos inferiores en la pared y retirar el calentador, luego taladrar los dos agujeros inferiores (Ø8) en la pared y poner la cubierta plástica del tornillo de expansión en los agujeros.
5. Colgar el calentador en la pared e insertar los tornillos de expansión en los dos agujeros inferiores.



ADVERTENCIA! Antes de poner en marcha el aparato, asegúrese de que está correctamente fijado a la pared. Si el aparato no está nivelado, pueden producirse problemas técnicos.

## FUNCIONAMIENTO

### PANEL DE CONTROL

-  Botón ON / OFF
-  Ajuste hora, día y temperatura
-  Selección modo y programas
-  Aumentar
-  Disminuir

### PANTALLA LCD

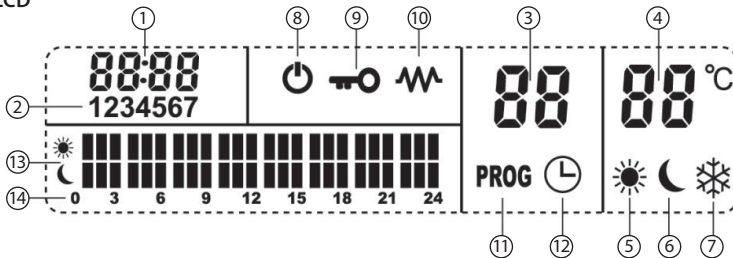



- |                             |                             |
|-----------------------------|-----------------------------|
| 1 - Hora                    | 8 - ON/OFF                  |
| 2 - Día                     | 9 - Bloqueo                 |
| 3 - Número programa         | 10 - Calefacción encendida  |
| 4 - Programa de temperatura | 11 - Selección de programa  |
| 5 - Modo confort            | 12 - Temporizador           |
| 6 - Modo económico          | 13 - Contenido del programa |
| 7 - Modo anti-heladas       | 14 - Escala de tiempo       |

El radiador tiene tres modos de funcionamiento diferentes.

1. Un modo de funcionamiento libre **F<sub>r</sub>** con temporizador de funcionamiento.
2. Un modo de programa diario que incluye 9 programas diferentes de **P 1** a **P 9** con la combinación de dos modos de funcionamiento: confort ☀, económico 🌙 y antiheladas ❄.
3. Un modo de programación semanal **RU** : asignando un programa diario para cada día de la semana.











**MODO DE FUNCIONAMIENTO LIBRE**









Pulsar , el icono  desaparece. El aparato está ahora funcionando en modo libre **F<sub>r</sub>**. Temperatura preestablecida de 10°C.

Nota: en caso de fallo de corriente, la hora se repone a las 00:00 y el calentador se reiniciará con la última función utilizada antes del corte.



**Ajuste del día y la hora**





- Pulsar una vez , las horas parpadean, después usar los botones  y  para ajustar las horas.
- Pulsar de nuevo , los minutos parpadean, después usar los botones  y  para ajustar los minutos.
- Pulsar de nuevo , la fecha parpadea, después usar los botones  y  para seleccionar el día: 1- Lunes, 2 - Martes, 3 - Miércoles, 4 - Jueves, 5 - Viernes, 6 - Sábado, 7 - Domingo.
- Pulsar una vez más  para confirmar.

**Ajuste de la temperatura**

- Pulsar una vez  o . La temperatura parpadea.
- Pulsar de nuevo  o  para ajustar la temperatura deseada. (la temperatura se puede ajustar en un rango de 10°C a 35°C).
- Tras 5 segundos sin pulsar ninguno de los botones  o , la temperatura es validada.

**Temporizador**

Pulsar  durante 3 segundos, el icono  aparece. Al mismo tiempo la pantalla de la hora parpadea y pasará a las 00:00.

Pulsar los botones  y  para elegir el tiempo de funcionamiento en intervalos de 30 minutos. Tras 5 segundos sin pulsar ninguno de los botones  o , el temporizador es validado. Una vez que el tiempo del temporizador haya transcurrido, el radiador pasará automáticamente a modo de espera .





Nota: Para salir del modo temporizador, pulsar  3 segundos. El radiador vuelve al modo libre **F<sub>r</sub>**.

**USO DE DIFERENTES PROGRAMAS**

**Selección del modo de funcionamiento:**

- RU** Programa semanal
- P 1\_P 9** Programa diario que se repite todos los días
- F<sub>r</sub>** Modo de funcionamiento libre

Aumentar o disminuir la temperatura utilizando  o .



- 1- Pulsar  una vez.
- 2- Elegir **RU**, **F<sub>r</sub>**, **P1**...**P9** usando  o .
- 3- Pulsar  una vez para confirmar.

NOTA: Si después de seleccionar el programa, no se pulsar ningún botón del panel de control durante 5 segundos, la selección se confirma automáticamente.



### Daily program

El radiador tiene 9 programas diarios que van desde **P1** a **P9**.

Cada segmento, que representa una hora del día, puede ser asignado al modo de funcionamiento:







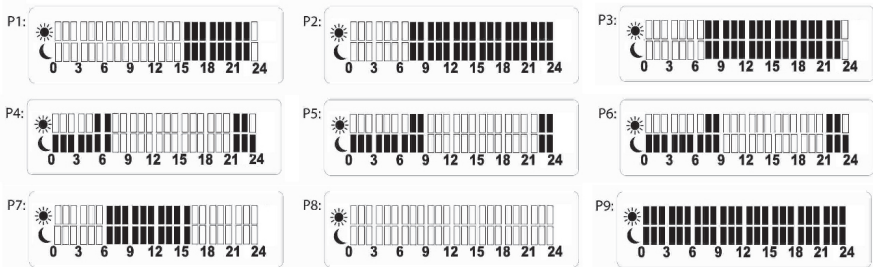

- para modo confort 
- para modo económico 
- para modo anti-heladas 

Los 9 programas han sido preestablecidos de la siguiente manera:

- para modo confort , temperatura de 22°C.
- para modo económico , temperatura de 17°C.
- para modo anti-heladas , temperatura de 7°C (este modo no puede personalizarse).



### Personalización del modo de funcionamiento confort y económico

- 1- En el programa diario de P1 a P9, pulsar  durante 3 segundos, el indicador de temperatura parpadea.
- 2- Usar  o  para ajustar la temperatura deseada para el modo de confort.
- 3- Pulsar  para confirmar su selección, el indicador de temperatura parpadea.
- 4- Usar  o  para ajustar la temperatura deseada para el modo económico.
- 5- Pulsar  para confirmar su selección.
- 6- El radiador vuelve automáticamente al modo de confort .

NOTA :



Si se modifican la temperatura de confort y la temperatura ECO de un programa diario (P1 a P9), también se modificarán todos los programas diarios y la temperatura de confort y ECO del modo automático.



NOTA :

1. Si después de seleccionar el programa no se pulsa ningún botón del panel de control durante 5 segundos, la selección se confirma automáticamente.
2. Si se modifica un programa diario (P1 a P9) confort y temperatura ECO, se modificarán todos los programas diarios y la temperatura de confort y ECO del modo automático.





### Personalización de los programas diarios:

Pulsar , elegir el programa que desea personalizar de P1 a P9 usando  o .

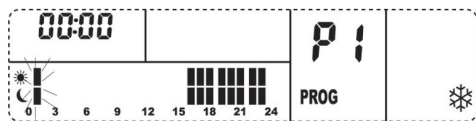

- 1- Pulsar  durante 3 segundos, el icono PROG aparece en la pantalla.
- 2- El primer segmento  de 00 : 00 parpadea.

Ejemplo de programa P1:



Usar  para elegir cómo asignar esta primera hora.

(  para modo confort,  para modo económico y  para modo anti-heladas).





- 3- Usar  o  para ir a la hora siguiente o anterior del programa. Repita 2 hasta que cada segmento del programa sea personalizado.

- 4- Pulsar  durante 3 segundos para confirmar su programa. El icono PROG desaparece de la pantalla.

NOTA: El nuevo programa reemplaza al antiguo programa de la memoria del aparato.

Si sus ajustes personales no le satisfacen, puede volver a la configuración de fábrica. Apagar el aparato con el interruptor que se encuentra en la parte posterior del mismo. Luego pulsar  durante 7 segundos para reiniciar el aparato.

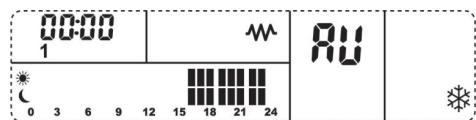

### Programación semanal

- 1- Pulsar  una vez.
- 2- Elegir el programa diario RU usando  r .
- 3- Pulsar  una vez para confirmar.

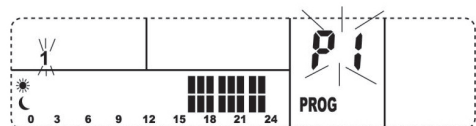

- 4- Pulsar  durante 3 segundos, el icono PROG aparece en la pantalla.
- 5- El número 1, que representa el LUNES y el programa correspondiente P1 parpadearán.





- 6- Asignar con  o  un programa (de P1 a P9) para el lunes. Confirmar la selección con . El número 2 parpadeará, representando el martes. Repetir hasta haber asignado un programa para cada día de la semana (1 - a 7 lunes-domingo).

7- Después de asignar el programa a 7-Domingo, confirmar la selección con . El icono PROG desaparece de la pantalla.

- 8- El calentador funciona entonces de acuerdo con el nuevo programa semanal que acaba de crear.

### FUNCIÓN DE VENTANA ABIERTA

Su calentador tiene una función de ventana abierta. Si abre una ventana ampliamente en el espacio donde se encuentra el calentador y la temperatura baja más de 2°C en 5 minutos, un sensor detectará el fuerte descenso de la temperatura. El calentador se apagará automáticamente y el símbolo **F0** parpadeará en su pantalla. El calentador volverá al modo anterior si la temperatura de la habitación sube más de 2°C en 5 minutos. Sin embargo, puede reiniciar el calentador manualmente pulsando . El símbolo **F0** desaparece de la pantalla. En el modo de espera, pulsar el botón  durante 5 segundos, el símbolo **F0** aparece en la pantalla y el símbolo **OF** parpadea en la pantalla, **OF** indica "función no en funcionamiento".



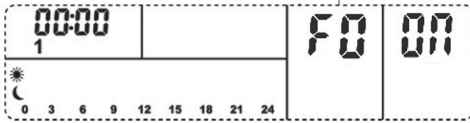

Pulsar  o  para cambiar el símbolo de **OF** a **ON**, **ON** indica "función en funcionamiento".



### BLOQUEO

El aparato se bloqueará automáticamente si se deja desatendido durante 30 segundos.

Para desbloquear el radiador en cualquier momento (un icono de una llave será visible en el panel central izquierdo de la pantalla) pulse  y  al mismo tiempo.

### CALIBRACIÓN DE LA TEMPERATURA

En el modo de espera, pulsar el botón  durante 10 segundos.

Primero, la pantalla saldrá F1, por favor note que esto se usa para el ajuste de la temperatura del sensor interno del calentador, por favor nunca lo ajuste.

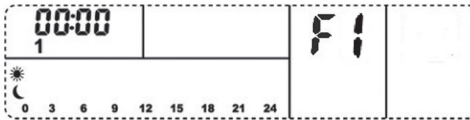

Segundo, después de que salga F1, pulsar el botón  para cambiar a F2, luego presione el botón  o  para cambiar la "calibración de temperatura" de -5°C a 5°C.

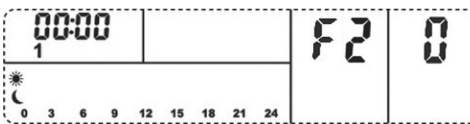

### DISPOSITIVO DE SEGURIDAD CONTRA SOBRECALENTAMIENTO

El radiador está equipado con un dispositivo de seguridad que apaga el calentador en caso de sobrecalentamiento. En caso de que el calentador deje de funcionar, apagar y realizar una inspección en las entradas y salidas de aire para ver si están obstruidas. Esperar al menos 5 minutos para que el sistema de protección se restablezca antes de reiniciar el calentador. Si el calentador no funciona o si el dispositivo de seguridad vuelve a apagarse, llevar el aparato al centro de servicio más cercano para que lo examinen o lo reparen.

## LIMPIEZA Y MANTENIMIENTO

- Apagar y desenchufar antes de limpiar el aparato.
- Dejar enfriar el aparato antes de limpiar.
- No sumergir en agua o en otro líquido. No permitir la entrada de agua en el aparato.
- Limpiar el aparato al menos una vez al año con una aspiradora para eliminar la acumulación de polvo.
- Para evitar cualquier riesgo eléctrico, limpiar el aparato con un trapo suave y limpio para eliminar el polvo.
- No utilice materiales químicos para la limpieza.
- Limpiar el aparato con regularidad.

## GARANTÍA

Las condiciones presentes en esta garantía se conceden en adición a todas las garantías implícitas, otros derechos y recursos en relación con el producto que el consumidor tiene bajo la Ley de Prácticas de Comercio y leyes similares estatales y territoriales. El comprador original de este producto dispone de la siguiente garantía, con sujeción a las siguientes condiciones. Este producto está garantizado por un período de 3 años en caso de "error de fabricación", el producto tendrá que ser devuelto a la tienda donde fue comprado para sustituirse de forma gratuita o reembolso del importe. Con el fin de obtener un cambio o un reembolso, es necesario presentar una prueba de compra al vendedor.

## RETIRADA DE LOS APARATOS DOMÉSTICOS USADOS



La directiva Europea 2012/19/EC sobre los Residuos de Aparatos Eléctricos y Electrónicos (RAEE), exige que los aparatos domésticos usados no se desechen en el flujo normal de los residuos municipales. Los aparatos usados deben ser recogidos por separado, a fin de optimizar la tasa de recuperación y el reciclaje de los materiales que entran en su composición y reducir el impacto sobre la salud humana y el medio ambiente.

## REQUISITOS DE INFORMACIÓN QUE DEBEN CUMPLIR LOS APARATOS DE CALEFACCIÓN LOCAL ELÉCTRICOS

Identificador(es) del modelo:		CERAMIC A			
Partida	Símbolo	Valor	Unidad	Partida	Unidad
Potencia calorífica <b>CERAMIC AC 1000</b>				<b>Tipo de aportación de calor, únicamente para los aparatos de calefacción local eléctricos de acumulación (seleccione uno)</b>	<b>N/A</b>
Potencia calorífica nominal	Pnom	1.0	kW	control manual de la carga de calor, con termostato integrado	[no]
Potencia calorífica mínima (indicativa)	Pmin		kW	control manual de la carga de calor con respuesta a la temperatura interior o exterior	[no]
Potencia calorífica máxima continuada	Pmax,c		kW	control electrónico de la carga de calor con respuesta a la temperatura interior o exterior	[no]
<b>Consumo auxiliar de electricidad</b>				potencia calorífica asistida por ventiladores	[no]
A potencia calorífica nominal	elmax	N/A	kW	<b>Tipo de control de potencia calorífica/de temperatura interior (seleccione uno)</b>	
A potencia calorífica mínima	elmin	N/A	kW	potencia calorífica de un solo nivel, sin control de temperatura interior	[no]
En modo de espera	eISB	N/A	kW	Dos o más niveles manuales, sin control de temperatura interior	[no]
Potencia calorífica <b>CERAMIC AC 1500</b>				con control de temperatura interior mediante termostato mecánico	[no]
Potencia calorífica nominal	Pnom	1.5	kW	con control electrónico de temperatura interior	[no]
Potencia calorífica mínima (indicativa)	Pmin		kW	control electrónico de temperatura interior y temporizador diario	[no]
Potencia calorífica máxima continuada	Pmax,c		kW	control electrónico de temperatura interior y temporizador semanal	[sí]
<b>Consumo auxiliar de electricidad</b>				<b>Otras opciones de control (pueden seleccionarse varias)</b>	<b>N/A</b>
A potencia calorífica nominal	elmax	N/A	kW	control de temperatura interior con detección de presencia	[no]
A potencia calorífica mínima	elmin	N/A	kW	control de temperatura interior con detección de ventanas abiertas	[sí]
En modo de espera	eISB	N/A	kW	con opción de control a distancia	[sí]
Potencia calorífica <b>CERAMIC AC 1800</b>				con control de puesta en marcha adaptable	[no]
Potencia calorífica nominal	Pnom	1.8	kW	con limitación de tiempo de funcionamiento	[no]
Potencia calorífica mínima (indicativa)	Pmin		kW	con sensor de lámpara negra	[no]
Potencia calorífica máxima continuada	Pmax,c		kW		
<b>Consumo auxiliar de electricidad</b>					
A potencia calorífica nominal	elmax	N/A	kW		
A potencia calorífica mínima	elmin	N/A	kW		
En modo de espera	eISB	N/A	kW		
Información de contacto		<b>CLIMACITY S.L.</b> C. Torrox, 2 - 5 · 28041 Madrid (ESPAÑA) - tel. +34 91 392 05 09			

Please read this manual carefully before use,  
and keep it for any future reference

#### TECHNICAL DATA

Model	Voltage	Frequency	Rated power	Class
CERAMIC AC 1000	230V~	50 Hz	1000W	II
CERAMIC AC 1500	230V~	50 Hz	1500W	II
CERAMIC AC 1800	230V~	50 Hz	1800W	II

#### SAFETY PRECAUTIONS



**CAUTION:** some parts of this product can become very hot and cause burns. Particular attention has to be given where children and vulnerable people are present.



**WARNING:** In order to avoid overheating, do not cover the heater.

- Children of less than 3 years should be kept away unless continuously supervised.
- Children aged from 3 years and less than 8 years shall only switch on or off the appliance provided that it has been placed or installed in its intended normal operating position and they have been given supervision or instruction concerning use of the appliance in a safe way and understand the hazards involved. Children aged from 3 years and less than 8 years shall not plug in, regulate and clean the appliance or perform user maintenance.
- This appliance can be used by children aged from 8 years and above and persons with reduced physical, sensory or mental capabilities or lack of experience and knowledge if they have been given supervision or instruction concerning use of the appliance in a safe way and understand the hazards involved. Children shall not play with the appliance. Cleaning and user maintenance shall not be made by children without supervision.
- Make sure the voltage is the same as that indicated on the rating plate of the appliance.
- To avoid the risk of electrical shock, make sure the appliance is unplugged from the electrical outlet before relocating, servicing, or cleaning it.
- Do not use the appliance if the cable is damaged.
- Keep this unit and its cord away from sources of heat, sharp objects, or anything

that could damage it.

- Ensure the appliance is switched off before connecting to the mains power supply.
- If the supply cord is damaged, it must be replaced by the manufacturer, its service agent or a similarly qualified person in order to avoid a hazard.
- The appliance must not be positioned directly underneath socket-outlet.
- Always place the unit on a stable, level surface and use it in an upright position.
- Do not operate the unit in areas where gasoline, paint or other flammable liquids may be used or stored.
- For indoor use only.
- To prevent a fire, do not block the air inlet and outlet in any way.
- Do not touch hot surfaces.
- Do not insert or allow foreign objects to enter any ventilation or exhaust opening as this will cause electric shock or fire and damage the unit.
- Always make sure your hands are dry before adjusting any switch or touching the unit.
- The main cause of overheating is due to dust deposits or residues in the unit. Make sure these foreign bodies are removed regularly. Unplug the unit from the network and clean it by vacuuming the air inlet and the grilles.
- The heater must be installed in such a way that switches and other controls can not be touched by anyone in the bath or shower.
- Do not use the unit with a timer, separate remote control system, or any other device that automatically turns on the unit, as there is a risk of fire if the unit is covered or placed incorrectly.
- When installing the radiator on its support, you must ensure that the electrical cable does not come into contact with the metal casing of the radiator.
- Appliance is to be supplied through a residual current device (RCD) having a rated residual operating current not exceeding 30 mA.
- Means for disconnection having a contact separation in all poles must be incorporated in the fixed wiring in accordance with the wiring rules.
- **CAUTION:** in order to avoid a hazard due to inadvertent resetting of the thermal cutout, this appliance must not be supplied through an external switching device, such as a timer, or connected to a circuit that is regularly switched on and off by the utility.

## INSTALLATION

The appliance must only be used and installed in a fixed position.

The installation must be carried out by a qualified electrician to avoid any danger.

- **IMPORTANT!** Make sure that there is no electrical wiring or other installation (water pipe for example) near the locations where the holes will be drilled. Be sure to fix the unit vertically and firmly to the wall.

- This appliance is intended for indoor installation and use only.

- The appliance should not be placed directly below a power outlet.

- Respect the minimum distances between the appliance and the walls, the floor, furniture, curtains, etc.

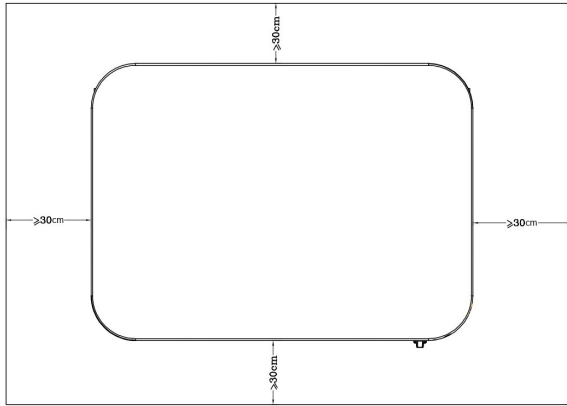

1. Be sure to keep the distance between the heater and floor, wall and so on at least 30cm.

2. Don't use in bathroom and don't cover.

3. Follow drill dimension to drill top two holes( $\Phi 8$ ) on the wall and put the expansion screws in the holes.

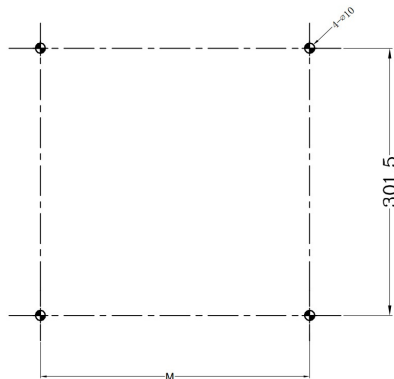

Model	Ceramic AC 1000	Ceramic AC1500	Ceramic AC 1800
M (mm)	228	378	378



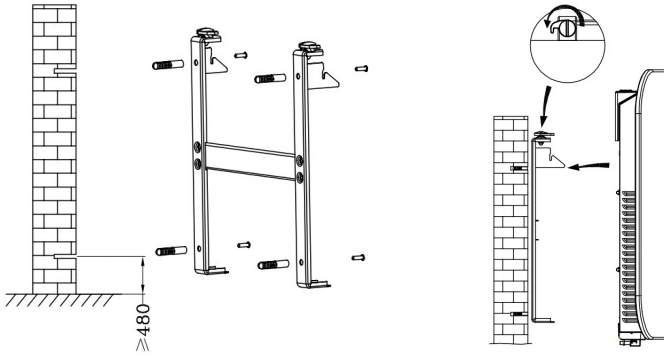

- The hook racks are pre-assembled on the back of the heater, hang the top two hook racks on the screws. Mark the two bottom hook racks' position on the wall and take away the heater, then drill bottom two holes(Ø8) on the wall and put expansion screw's plastic cover in the holes.
- Hang the heater on the wall and put the expansion screws in the bottom two holes.



**WARNING !** Before starting the appliance, make sure that it is properly fixed to the wall. If the device is not level, problems may occur.

## OPERATION

### CONTROL PANEL

-  ON / OFF button
-  Setting time, day and temperature
-  Selecting mode and programs
-  Increase of selected criterion
-  Decrease of selected criterion

### LCD SCREEN

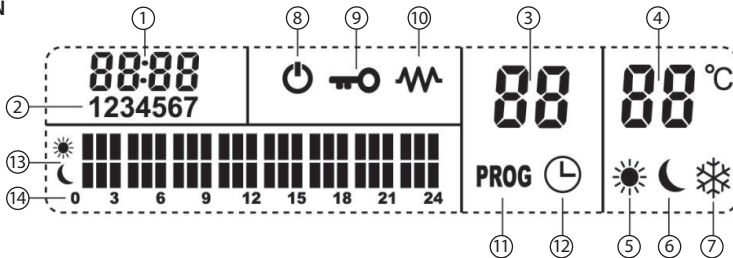

- 1 - Hour
- 2 - Day
- 3 - program number
- 4 - Temperature program
- 5 - Comfort mode
- 6 - Economic mode
- 7 - Frost mode

- 8 - ON/OFF
- 9 - Locking radiator
- 10 - Heating on
- 11 - Program selection
- 12 - Timer
- 13 - Program content
- 14 - Time scale





The radiator has three different operating Modes.

1. A free operating mode **F<sub>r</sub>** with running timer.
2. A daily program mode including 9 different programs from **P<sub>1</sub>** to **P<sub>9</sub>** combining two operating modes: comfort ☀, economic 🌙 and frost ❄.
3. A weekly program mode **RU**: assigning a daily schedule for every day of the week.











### FREE OPERATION MODE









Press , the icon  disappears. The device is now running free **F<sub>r</sub>**. Preset temperature of 10°C.

Remark: in case of power failure, Time is reset to 00:00 and the heater will restart to the last function used before cutting.







### Adjustement of day & time

- Press once , the hours are flashing, then use the buttons  and  to adjust the hours,
- Press again , the minutes are flashing, then use the buttons  and  to adjust the minutes,
- Press again , the date is flashing, then use the buttons  and  to select the day: 1-Monday, 2-Tuesday, 3-Wednesday, 4-Thursday, 5-Friday, 6-Saturday, 7-Sunday.
- Press once more  to confirm your choice.

### Temperature setting

- Press once  or . The temperature display flashes.
- Press again  or  to adjust the desired temperature. (the temperature can be set over a range of 10°C to 35°C).
- After 5 seconds without action on buttons  or , the temperature is validated.

### Timer

Press  for 3 seconds, the icon  appears. At the same time the hour display flashes and will pass at 00:00. Using the buttons  and  choose the operating time in steps of 30 minutes. After 5 seconds without action on the buttons  or , the duration is validated.

Once the timer duration has lapsed, the radiator will automatically go into standby .

Note: To exit the timer mode, press  3 seconds. The radiator returns to free operating mode **F<sub>r</sub>**.



### USE OF DIFFERENT PROGRAMS

#### Selection of the operating mode:

- RU** Weekly program  
**P<sub>1</sub>\_P<sub>9</sub>** Daily program that repeats itself every day  
**F<sub>r</sub>** Free operating mode

Increase or decrease the temperature by using  or .

1- Press  once.

2- Choose **RU**, **F<sub>r</sub>**, **P<sub>1</sub>\_P<sub>9</sub>** by using  or .



3- Press  once to confirm your choice

NOTE: If after selecting the program, no button on the keyboard is activated for 5 seconds, the selection is confirmed automatically.



### Daily program

The radiator has 9 daily programs ranging from **P 1** to **P 9**.

Each segment, representing a time of day, can be assigned to the operating mode:







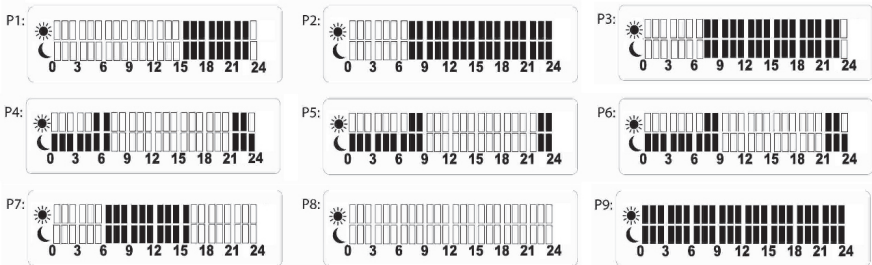

-  for comfort
-  for economic
-  for frost

The 9 programs have been preset at the factory as follows:

-  for comfort, temperature of 22°C.
-  for economic, temperature of 17°C.
-  for frost, temperature of 7°C (this mode cannot be personalised!).



### Personalisation of the operating mode and economic

- 1- Under P1 to P9 daily program, press  for 3 seconds, the temperature indicator flashes.
- 2- Use  or  to adjust the desired temperature for the comfort mode.
- 3- Press  to confirm your selection, the temperature indicator flashes.
- 4- Use  or  to adjust the desired temperature for the economic mode.
- 5- Press  to confirm your selection.
- 6- The radiator automatically returns to comfort mode .



NOTE :

If comfort and ECO temperature of one daily program (P1 to P9) modified, all daily programs and pilot wire mode's comfort and ECO temperature will be modified too.

NOTE :

1. If after selecting the program, no button on the keyboard is activated for 5 seconds, the selection is confirmed automatically.
2. If one daily program (P1 to P9) comfort and ECO temperature modified, all daily programs and pilot wire mode's comfort and ECO temperature will be modified.

### Personalisation of the Daily programs

Press , then choose the program you want to personalise from **P 1** to **P 9** by using  or .

- 1- Press  for 3 seconds, the icon PROG appears on the display.



restart the heater by pressing . The symbol **F0** disappears of the screen.

Under standby mode, press and hold  button for 5 seconds, symbol **F0** shows on the screen and symbol **OF** flickers on the screen. **OF** indicates "function not in operation".

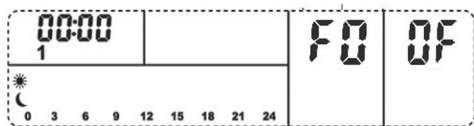

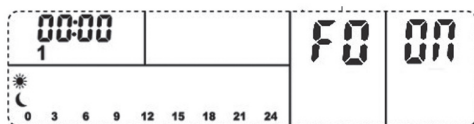

Press  or  button to change the symbol from **OF** to **ON**. **ON** indicates "function in operation".



### LOCK

The device will automatically lock if left unattended for 30 seconds.



To unlock the radiator at any time(a key icon will be visible in the middle left pane of the display) press  and  at the same time.

### TEMPERATURE CALIBRATION

Under standby mode, press and hold  button for 10 seconds:

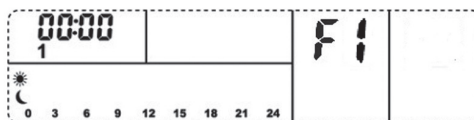
First, the screen will come out F1, please note this is used for heater's internal sensor temperature adjustment, please never adjust it.



Second, after F1 come out, press  button to change to F2, then press  or  button to change "temperature calibration" from -5°C to 5°C.

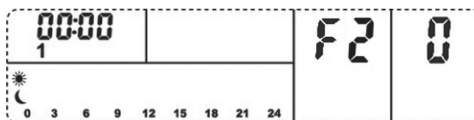

### SAFETY DEVICE FOR ANTI-OVERHEATING

The radiator is fitted with a safety device which switches off the heater in case of overheating. In case the heater stops working, turn off the heater and carry out an inspection at the entrances and air vents to see if they are clogged. Wait at least 5 minutes so that the protection system is reset before restarting the heater. If the heater does not work or if the safety device off again, bring the device to the service center nearest aftermarket for consideration or repaired.

## CLEANING & MAINTENANCE

- Always switch off the device and disconnect the power cord before cleaning.
- Let the heater cool down completely.
- Never immerse it in water or other liquid. Do not allow water to run into the appliance.
- Clean the unit at least once a year with a vacuum cleaner to remove any dust from the heap.
- Clean your heater with a soft damp cloth.
- Do not use chemical materials for the cleaning of your heater.
- Clean the appliance regularly.

## WARRANTY

The benefits conferred by this warranty are in addition to all implied warranties, other rights and remedies in respect of the product which the consumer has under the Trade Practices Act and similar State and Territory Laws. The original purchaser of this product is provided with the follow warranty, subject to the following conditions. This product is warranted for a period of 3 years from faulty, the product will need to be returned to the retailer where it was purchased to be replaced free of charge or a refund issued. In order to obtain an exchange or a refund, proof of purchase must be presented to the retailer.

## DISCARDING WORN HOUSEHOLD DEVICES



The European directive 2012/19/EC pertaining to electrical and electronic waste prohibits such household goods from being discarded with local refuse services. Worn devices must be collected separately to optimize the recovery and recycling rates of the components therein to reduce detrimental effects on the environment and on human health.

## INFORMATION REQUIREMENTS FOR ELECTRIC LOCAL SPACE HEATERS

Model identifier(s):		CERAMIC A			
Item	Symbol	Value	Unit	Item	Unit
Heat output <b>CERAMIC AC 1000</b>				<b>Type of heat input, for electric storage local space heaters only (select one)</b>	<b>N/A</b>
Nominal heat output	Pnom	1.0	kW	manual heat charge control, with integrated thermostat	[no]
Minimum heat output (indicative)	Pmin		kW	manual heat charge control with room and/or outdoor temperature feedback	[no]
Maximum continuous heat output	Pmax,c		kW	electronic heat charge control with room and/or outdoor temperature feedback	[no]
<b>Auxiliary electricity consumption</b>				fan assisted heat output	[no]
At nominal heat output	elmax	N/A	kW	<b>Type of heat output/room temperature control (select one)</b>	
At minimum heat output	elmin	N/A	kW	single stage heat output and no room temperature control	[no]
In standby mode	eISB	N/A	kW	Two or more manual stages, no room temperature control	[no]
Heat output <b>CERAMIC AC 1500</b>				with mechanic thermostat room temperature control	[no]
Nominal heat output	Pnom	1.5	kW	with electronic room temperature control	[no]
Minimum heat output (indicative)	Pmin		kW	electronic room temperature control plus day timer	[no]
Maximum continuous heat output	Pmax,c		kW	electronic room temperature control plus week timer	[yes]
<b>Auxiliary electricity consumption</b>				<b>Other control options (multiple selections possible)</b>	<b>N/A</b>
At nominal heat output	elmax	N/A	kW	room temperature control, with presence detection	[no]
At minimum heat output	elmin	N/A	kW	room temperature control, with open window detection	[yes]
In standby mode	eISB	N/A	kW	with distance control option	[yes]
Heat output <b>CERAMIC AC 1800</b>				with adaptive start control	[no]
Nominal heat output	Pnom	1.8	kW	with working time limitation	[no]
Minimum heat output (indicative)	Pmin		kW	with black bulb sensor	[no]
Maximum continuous heat output	Pmax,c		kW		
<b>Auxiliary electricity consumption</b>					
At nominal heat output	elmax	N/A	kW		
At minimum heat output	elmin	N/A	kW		
In standby mode	eISB	N/A	kW		
Información de contacto		<b>CLIMACITY S.L.</b> C. Torrox, 2 - 5 · 28041 Madrid (ESPAÑA) tel. +34 91 392 05 09			

Lisez ces instructions attentivement avant l'utilisation,  
et conservez-les pour de futures consultations.

## INFORMATIONS TECHNIQUES

Modèle	Voltage	Fréquence	Puissance	Clase
CERAMIC AC 1000	230V~	50 Hz	1000W	II
CERAMIC AC 1500	230V~	50 Hz	1500W	II
CERAMIC AC 1800	230V~	50 Hz	1800W	II

## PRÉCAUTIONS DE SÉCURITÉ



**ATTENTION** : Certaines parties de ce produit peuvent devenir très chaude et provoquer des brûlures. Il faut prêter une attention particulière en présence d'enfants et de personnes vulnérables.



**AVERTISSEMENT**: Afin d'éviter une surchauffe, ne pas couvrir l'appareil.

- Il convient de maintenir à distance de cet appareil les enfants de moins de 3 ans, à moins qu'ils ne soient sous une surveillance continue.
- Les enfants âgés entre 3 ans et 8 ans doivent uniquement mettre l'appareil en marche ou à l'arrêt, à condition que ce dernier ait été placé ou installé dans une position normale prévue et que ces enfants disposent d'une surveillance ou aient reçu des instructions quant à l'utilisation de l'appareil en toute sécurité et en comprennent bien les dangers potentiels. Les enfants âgés entre 3 ans et 8 ans ne doivent ni brancher, ni régler, ni nettoyer l'appareil, et ni réaliser l'entretien de l'utilisateur.
- Cet appareil peut être utilisé par des enfants âgés d'au moins 8 ans et par des personnes ayant des capacités physiques, sensorielles ou mentales réduites ou dénuées d'expérience ou de connaissance, s'ils (si elles) sont correctement surveillé(e)s ou si des instructions relatives à l'utilisation de l'appareil en toute sécurité leur ont été données et si les risques encourus ont été appréhendés. Les enfants ne doivent pas jouer avec l'appareil. Le nettoyage et l'entretien par l'utilisateur ne doivent pas être effectués par des enfants sans surveillance.
- Assurez-vous que la tension est la même que celle indiquée sur la plaque signalétique de l'appareil.
- Pour éviter tout risque de chocs électriques, assurez-vous que l'appareil est débranché de la prise de courant avant le déménagement, l'entretien ou le nettoyage.
- N'utilisez pas l'appareil si le câble est endommagé.

- Gardez cet appareil et son cordon d'alimentation loin des sources de chaleur, des objets pointus ou de tout ce qui pourrait l'endommager.
- Si le câble d'alimentation est endommagé, il doit être remplacé par le fabricant, son service après-vente ou des personnes de qualification similaire afin d'éviter un danger.
- Assurez-vous que l'appareil est éteint avant de le brancher sur le secteur.
- Ne pas placer l'appareil juste en dessous d'une prise de courant murale.
- Placez toujours l'appareil sur une surface stable et plane et utilisez-le en position verticale.
- Ne faites pas fonctionner l'appareil dans des endroits où de l'essence, de la peinture ou d'autres liquides inflammables peuvent être utilisés ou stockés.
- Pour une utilisation à l'intérieur uniquement.
- Pour prévenir un incendie, ne bloquez pas l'entrée et la sortie d'air de quelque manière que ce soit.
- Ne pas toucher les surfaces chaudes.
- N'insérez pas ou ne laissez pas d'objets étrangers pénétrer dans les ouvertures de ventilation ou d'évacuation, car cela pourrait provoquer un choc électrique ou un incendie et endommager l'appareil.
- Assurez-vous toujours que vos mains sont sèches avant de régler un interrupteur ou de toucher l'appareil.
- La principale cause de surchauffe est due à des dépôts de poussière ou à des résidus dans l'appareil. Assurez-vous que ces corps étrangers sont enlevés régulièrement. Débranchez l'appareil du réseau et nettoyez-le en aspirant l'entrée d'air et les grilles.
- Le chauffage doit être installé de telle manière que les interrupteurs et autres commandes ne puissent être touchés par quiconque dans la baignoire ou la douche.
- N'utilisez pas l'appareil avec une minuterie, un système de télécommande séparé ou tout autre dispositif qui allume automatiquement l'appareil, car il y a un risque d'incendie si l'appareil est couvert ou mal placé.
- Lorsque vous installez le radiateur sur son support, vous devez vous assurer que le câble électrique n'entre pas en contact avec l'enveloppe métallique du radiateur.
- L'appareil doit être alimenté à travers un dispositif de protection contre les courants de court-circuit calibré pour 30 mA.
- Des moyens de déconnexion avec un espacement entre chaque pôle doivent être prévus dans le câblage fixe de l'appareil conformément aux règles d'installation en vigueur.
- ATTENTION : afin d'éviter tout danger causé par une remise à zéro involontaire du système de sécurité, cet appareil ne doit pas être alimenté par un programmeur, une minuterie, ou tout autre dispositif qui met l'appareil de chauffage sous tension automatiquement.



## INSTALLATION

L'appareil ne doit être utilisé et installé que dans une position fixe conformément à la norme NFC 15-100.

L'installation doit être effectuée par un électricien qualifié afin d'éviter tout danger.

- IMPORTANT ! Assurez-vous qu'il n'y a pas de câblage électrique ou d'autre installation (tuyau d'eau par exemple) à proximité des endroits où les trous seront percés. Veillez à fixer l'appareil verticalement et fermement au mur.
- Cet appareil est destiné à être installé et utilisé à l'intérieur uniquement.
- L'appareil ne doit pas être placé directement au-dessus d'une prise de courant.
- Respectez les distances minimales entre l'appareil et les murs, le sol, les meubles, les rideaux, etc.

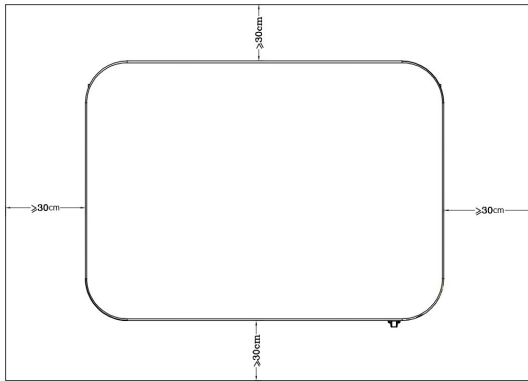

1. Veillez à ce que la distance entre le chauffage et le sol, le mur, etc. soit d'au moins 30 cm.
2. Ne pas utiliser dans la salle de bain et ne pas couvrir.
3. Suivez les dimensions de la perceuse pour percer les deux trous supérieurs ( $\Phi 8$ ) sur le mur et mettez les vis d'expansion dans les trous.

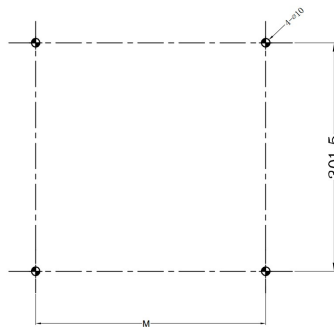

Modèle	Ceramic AC 1000	Ceramic AC 1500	Ceramic AC 1800
M(mm)	228	378	378

4. Les supports à crochets sont préassemblés à l'arrière du chauffage, accrochez les deux supports à crochets supérieurs aux vis. Marquez la position des deux supports de crochets inférieurs sur le mur et retirez le poêle, puis percez les deux trous inférieurs ( $\Phi 8$ ) sur le mur et placez le couvercle en plastique des vis d'expansion dans les trous.



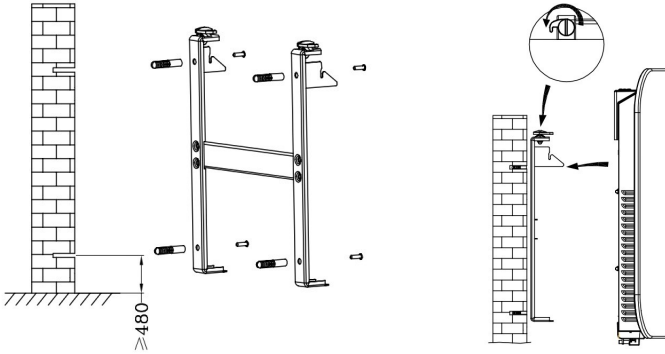

5. Accrochez le chauffage au mur et placez les vis d'expansion dans les deux trous du bas.



ATTENTION ! Avant de mettre l'appareil en marche, assurez-vous qu'il est bien fixé au mur. Si l'appareil n'est pas de niveau, des problèmes peuvent survenir.

## FONCTIONNEMENT

### PANNEAU DE CONTRÔLE

-  Bouton ON / OFF
-  Réglage de l'heure, du jour et de la température
-  Sélection du mode et des programmes
-  Augmenter
-  Diminuer

### ECRAN LCD

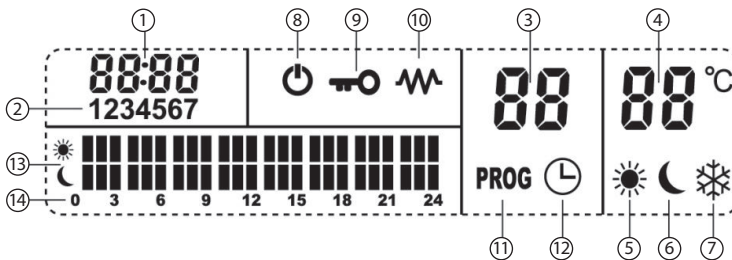

- |                              |                               |
|------------------------------|-------------------------------|
| 1 - Heure                    | 8 - ON/OFF                    |
| 2 - Jour                     | 9 - Verrouillage du radiateur |
| 3 - Numéro du programme      | 10 - Chauffage                |
| 4 - Programme de température | 11 - Sélection du programme   |
| 5 - Mode confort             | 12 - Minuteur                 |
| 6 - Mode économique          | 13 - Contenu du programme     |
| 7 - Mode anti-gel            | 14 - Echelle de temps         |

Le radiateur a trois modes de fonctionnement différents.

1. Un mode de fonctionnement libre **F<sub>r</sub>** avec minuterie.
2. Un mode programme journalier comprenant 9 programmes différents de **P1** à **P9** combinant de deux modes de fonctionnement : confort ☀, économique 🌙 et anti-gel ❄.
3. Un mode de programmation hebdomadaire **RU** : attribution d'un programme journalier pour chaque jour de la semaine.

### MODE DE FONCTIONNEMENT LIBRE

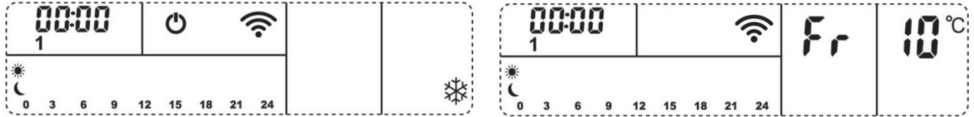

Appuyez sur , l'icône disparaît. L'appareil fonctionne maintenant librement **F<sub>r</sub>**. Température pré-réglée de 10°C.

Remarque : en cas de coupure de courant, l'heure est remise à 00:00 et le chauffage redémarre sur la dernière fonction utilisée avant la coupure.

### Réglage du jour et de l'heure

- Appuyez une fois sur , les heures clignotent, puis utilisez les boutons et pour ajuster les heures.
- Appuyez à nouveau sur la touche , les minutes clignotent, puis utilisez les touches et pour régler les minutes.
- Appuyez à nouveau sur la touche , la date clignote, puis utilisez les touches et pour sélectionner le jour : 1 - lundi, 2 - mardi, 3 - mercredi, 4 - jeudi, 5 - vendredi, 6 - samedi, 7 - dimanche.
- Appuyez une nouvelle fois pour confirmer votre choix.

### Réglage de la température

- Appuyez une fois sur ou . L'affichage de la température clignote.
- Appuyez à nouveau sur ou pour régler la température souhaitée. (la température peut être réglée sur une plage de 10°C à 35°C).
- Après 5 secondes sans action sur les boutons ou , la température est validée.

### Minuterie

Appuyez pendant 3 secondes, l'icône apparaît. Au même moment, l'affichage des heures clignote et passe à 00:00.

Utilisez les boutons et choisissez le temps de fonctionnement par étapes de 30 minutes. Après 5 secondes sans action sur les boutons ou , la durée est validée.



Une fois la durée de la minuterie écoulée, le radiateur se met automatiquement en veille .

Note : Pour quitter le mode minuterie, appuyez sur 3 secondes et le radiateur revient en mode de fonctionnement libre **F<sub>r</sub>** .



### UTILISATION DES DIFFÉRENTS PROGRAMMES

#### Sélection du mode de fonctionnement:

- RU** Programme hebdomadaire
- P1\_P9** Programme quotidien qui se répète tous les jours
- F<sub>r</sub>** Mode de fonctionnement libre

Augmenter ou diminuer la température en utilisant  ou 

1- Appuyez  une fois.

2- Choisissez **RU**, **Fr**, **P1** à **P9** en utilisant  ou .







3- Appuyez  une fois sur pour confirmer votre choix

NOTE : Si après avoir sélectionné le programme, aucun bouton du clavier n'est activé pendant 5 secondes, la sélection est confirmée automatiquement.







### Programme quotidien

Le radiateur comporte 9 programmes quotidiens allant de **P1** à **P9**.

Chaque segment, représentant un moment de la journée, peut être affecté au mode de fonctionnement:

-  pour le mode confort, 
-  pour le mode économique 
-  pour le mode anti-gel 

The 9 programs have been preset at the factory as follows:

-  pour le mode confort, , température de 22°C.
-  pour le mode économique , température de 17°C.
-  pour le mode anti-gel , température de 7°C (ce mode ne peut pas être personnalisé).

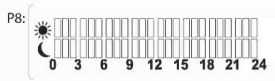
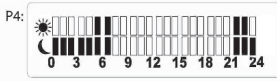
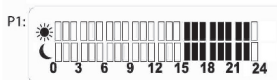

### Personnalisation du mode de fonctionnement confort et économique

1- Sous le programme journalier P1 à P9, appuyez  pendant 3 secondes, l'indicateur de température clignote.

2- Utilisez  ou , pour régler la température souhaitée pour le mode confort.

3- Appuyez sur  pour confirmer votre sélection, l'indicateur de température clignote.

4- Utilisez  ou , pour régler la température désirée pour le mode économique.

5- Appuyez sur  pour confirmer votre sélection.

6- Le radiateur revient automatiquement en mode confort .

NOTE :



Si la température confort et la température ECO d'un programme journalier (P1 à P9) sont modifiées, tous les programmes journaliers et la température confort et ECO du mode automatique seront également modifiés.



NOTE :

1. Si, après avoir sélectionné le programme, aucune touche du clavier n'est activée pendant 5 secondes, la sélection est automatiquement confirmée.

2. Si un programme journalier (P1 à P9) confort et température ECO est modifié, tous les programmes journaliers et les modes automatiques confort et température ECO seront modifiés.

### Personnalisation des programmes journaliers:



Appuyez sur , puis choisissez le programme que vous souhaitez personnaliser de P 1 à P9, en utilisant  ou .

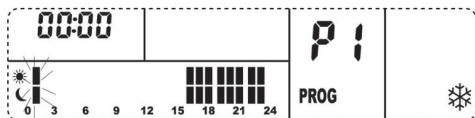

- 1- Appuyez  pendant 3 secondes, l'icône PROG apparaît sur l'écran.
- 2- Le premier segment  de 00 : 00 clignote.

Exemple de programme P1 :



Utilisez  pour choisir la répartition de cette première heure.

(  pour le confort,  pour l'économie et  pour le mode anti-gel )

3- Utilisez  ou  pour passer à l'heure suivante ou précédente du programme. Répétez 2 jusqu'à ce que chaque segment du programme soit personnalisé.





- 4- Appuyez  pendant 3 secondes pour confirmer votre programme. L'icône PROG disparaît à l'écran.

REMARQUE : Le nouveau programme remplace l'ancien programme dans la mémoire de l'appareil.

Si vos réglages personnels ne vous satisfont pas, vous pouvez revenir aux préréglages d'usine. Éteignez l'appareil à l'aide de l'interrupteur situé à l'arrière de l'appareil. Ensuite, appuyez sur la touche  pendant 7 secondes pour réinitialiser l'appareil.

La personnalisation des programmes quotidiens doit être effectuée avant la programmation hebdomadaire.

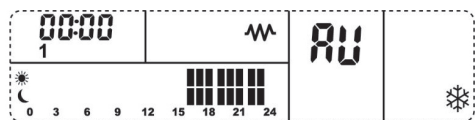

### Programmation hebdomadaire

- 1- Appuyez  une fois.
- 2- Choisissez le programme quotidien RU en utilisant  ou .
- 3- Appuyez  une fois pour confirmer votre choix .

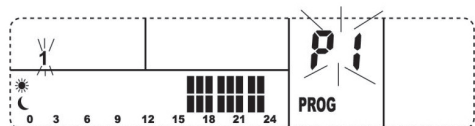

- 4- Appuyez  pendant 3 secondes, l'icône PROG apparaît sur l'écran.
- 5- Le chiffre 1, représentant le LUNDI et le programme correspondant P1 clignotent.





6- Attribuez à l'aide de  ou  un programme (de P1 à P9) pour le lundi. Validez votre sélection avec . Le chiffre 2, représentant le mardi, s'affichera en aveugle. Répétez l'opération jusqu'à ce que vous ayez attribué un programme pour chaque jour de la semaine (1 - à 7 lundi-dimanche)

7- Après avoir attribué le programme au 7-Dimanche, confirmez votre sélection avec . L'icône PROG disparaît à l'écran.



- 8- Le chauffage fonctionne alors selon le nouveau programme hebdomadaire que vous venez de créer.

## FONCTION D'OUVERTURE DE FENÊTRE

Votre chauffage a une fonction de fenêtre ouverte. Si vous ouvrez largement une fenêtre dans l'espace où se trouve le chauffage et que la température baisse de plus de 2°C en 5 minutes, un capteur détectera la forte baisse de température. Le chauffage s'éteint automatiquement et le symbole **FO** clignote sur votre écran. Le chauffage revient au mode précédent si la température de la pièce augmente de plus de 2°C en 5 minutes. Vous pouvez toutefois redémarrer manuellement le chauffage en appuyant sur . Le symbole **FO** disparaît de l'écran.

En mode veille, appuyez sur le bouton  pendant 5 secondes, le symbole **FO** s'affiche à l'écran et le symbole **OF** clignote à l'écran, **OF** indique "fonction non opérationnelle".



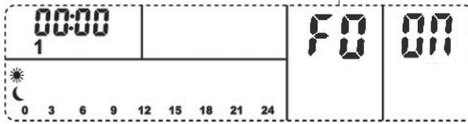

Appuyez sur la touche  ou  pour changer le symbole de **OF** à **ON**, **ON** indique "fonction en cours de fonctionnement".



## VERROUILLAGE

L'appareil se verrouille automatiquement s'il est laissé sans surveillance pendant 30 secondes.



Pour déverrouiller le radiateur à tout moment (une icône de clé sera visible dans le panneau central gauche de l'écran), appuyez sur  et  en même temps.

## CALIBRAGE DE LA TEMPÉRATURE

En mode veille, appuyez sur le bouton  et maintenez-le enfoncé pendant 10 secondes :

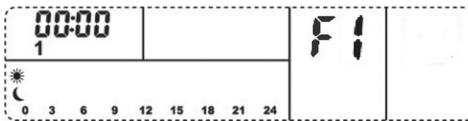
D'abord, l'écran sortira F1, veuillez noter qu'il sert à ajuster la température du capteur interne du chauffage, veuillez ne jamais l'ajuster.



Deuxièmement, après que F1 soit sorti, appuyez sur le bouton  pour passer à F2, puis appuyez sur le bouton  ou  pour changer "l'étalonnage de la température" de -5°C à 5°C.

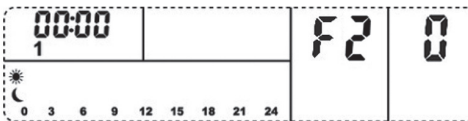

## DISPOSITIF DE SÉCURITÉ ANTI-SURCHAUFFE

Le radiateur est équipé d'un dispositif de sécurité qui coupe le chauffage en cas de surchauffe. Si le radiateur cesse de fonctionner, arrêtez-le et procédez à une inspection des entrées et des bouches d'aération pour voir si elles sont bouchées. Attendez au moins 5 minutes pour que le système de protection soit rétabli avant de redémarrer le chauffage. Si le chauffage ne fonctionne pas ou si le dispositif de sécurité est à nouveau éteint, apportez l'appareil au centre de service le plus proche du marché des pièces détachées pour qu'il soit examiné ou réparé.

## NETTOYAGE & ENTRETIEN

- Toujours éteindre l'appareil et débrancher le cordon d'alimentation avant le nettoyage.
- Laisser complètement refroidir l'appareil.
- Ne jamais l'immerger dans de l'eau ou d'un autre liquide. Ne laissez pas l'eau entrer dans l'appareil.
- Nettoyez l'appareil au moins une fois par an avec un aspirateur pour enlever la accumulation de poussière.
- Nettoyez votre radiateur avec un chiffon humide et doux.
- N'utilisez pas de produits chimiques pour le nettoyage de votre appareil de chauffage.
- Nettoyez l'appareil régulièrement.

## GARANTIE

Les conditions présentes dans cette garantie s'ajoutent à toutes les garanties implicites, aux autres droits et aux ressources en rapport avec le produit dont le consommateur bénéficie grâce à la Loi sur les Pratiques du Commerce et les lois similaires de l'Etat et des territoires. L'acheteur d'origine de ce produit possède les garanties suivantes, soumises aux conditions suivantes. Ce produit est garanti 3 années, en cas de défaut de fabrication, le produit devra être rendu au magasin où il a été acheté pour être remplacé de manière gratuite ou contre remboursement du montant d'achat. Afin de pouvoir l'échanger ou d'être remboursé, il est nécessaire de présenter une preuve d'achat au vendeur.

## RECYCLAGE DES APPAREILS DOMESTIQUES USÉS



La directive Européenne 2012/19/EC sur les Résidus des Equipements Électriques et Électroniques (RAEE), précise que les appareils domestiques usés ne doivent pas être jetés avec les ordures ménagères. Les appareils usés doivent être recyclés séparément, afin d'optimiser le taux de récupération et le recyclage des matériaux qui le composent et réduire l'impact sur la santé humaine et sur l'environnement.

## EXIGENCES D'INFORMATIONS APPLICABLES AUX DISPOSITIFS DE CHAUFFAGE DÉCENTRALISÉS ÉLECTRIQUES

Référence(s) du modèle:		CERAMIC A			
Caractéristique	Symbole	Valeur	Unité	Caractéristique	Unité
Puissance thermique <b>CERAMIC AC 1000</b>				Type d'apport de chaleur, pour les dispositifs de chauffage décentralisés électriques à accumulation uniquement (sélectionner un seul type)	N/A
Puissance thermique nominale	Pnom	1.0	kW	contrôle thermique manuel de la charge avec thermostat intégré	[non]
Puissance thermique minimale (indicative)	Pmin		kW		
Puissance thermique maximale continue	Pmax,c		kW	contrôle thermique manuel de la charge avec réception d'informations sur la température de la pièce et/ou extérieure	[non]
<b>Consommation d'électricité auxiliaire</b>				contrôle thermique électronique de la charge avec réception d'informations sur la température de la pièce et/ou extérieure	[non]
À la puissance thermique nominale	elmax	N/A	kW		
À la puissance thermique minimale	elmin	N/A	kW		
En mode veille	eISB	N/A	kW		
Puissance thermique <b>CERAMIC AC 1500</b>				<b>Type de contrôle de la puissance thermique/de la température de la pièce (sélectionner un seul type)</b>	
Puissance thermique nominale	Pnom	1.5	kW	contrôle de la puissance thermique à un palier, pas de contrôle de la température de la pièce	[non]
Puissance thermique minimale (indicative)	Pmin		kW		
Puissance thermique maximale continue	Pmax,c		kW	contrôle à deux ou plusieurs paliers manuels, pas de contrôle de la température de la pièce	[non]
<b>Consommation d'électricité auxiliaire</b>				contrôle de la température de la pièce avec thermostat mécanique	[non]
À la puissance thermique nominale	elmax	N/A	kW		
À la puissance thermique minimale	elmin	N/A	kW		
En mode veille	eISB	N/A	kW		
Puissance thermique <b>CERAMIC AC 1800</b>				contrôle électronique de la température de la pièce et programmeur hebdomadaire	[oui]
Puissance thermique nominale	Pnom	1.8	kW	<b>Autres options de contrôle (sélectionner une ou plusieurs options)</b>	N/A
Puissance thermique minimale (indicative)	Pmin		kW		
Puissance thermique maximale continue	Pmax,c		kW	contrôle de la température de la pièce, avec détecteur de présence	[non]
<b>Consommation d'électricité auxiliaire</b>				contrôle de la température de la pièce, avec détecteur de fenêtre ouverte	[oui]
À la puissance thermique nominale	elmax	N/A	kW	option contrôle à distance	[oui]
À la puissance thermique minimale	elmin	N/A	kW	contrôle adaptatif de l'activation	[non]
En mode veille	eISB	N/A	kW	limitation de la durée d'activation	[non]
Coordonnées de contact				capteur à globe noir	[non]
		<b>CLIMACITY S.L.</b> C. Torrox, 2 - 5 · 28041 Madrid (ESPAÑA) tel. +34 91 392 05 09			



É favor ler atentamente o manual antes de utilizar o aparelho.  
Guardar estas instruções.

### ESPECIFICAÇÕES TÉCNICAS

Modelo	Alimentação	Frequência	Potência	Clase
CERAMIC AC 1000	230V~	50 Hz	1000W	II
CERAMIC AC 1500	230V~	50 Hz	1500W	II
CERAMIC AC 1800	230V~	50 Hz	1800W	II

### ADVERTÊNCIAS DE SEGURANÇA



**ATENÇÃO:** algumas peças deste produto podem tornar-se muito quentes e causar queimaduras. Especial atenção deve ser dada onde crianças e pessoas vulneráveis estão presentes.



**ADVERTÊNCIA:** Para evitar o sobreaquecimento, não cubra o aquecedor.

- Crianças com menos de 3 anos devem ser mantidas afastadas, a menos que sejam continuamente supervisionadas.
- Crianças com idades entre 3 e 8 anos só devem ligar/desligar o aparelho desde que ele tenha sido colocado ou instalado na sua posição normal de utilização e que lhes tenha sido dada supervisão ou instruções relativas à utilização do aparelho de forma segura e compreendem os perigos envolvidos. Crianças com idades entre 3 e 8 anos não devem ligar, regular e limpar o aparelho ou realizar a manutenção.
- Este aparelho pode ser utilizado por crianças a partir de 8 anos e acima e por pessoas com capacidades físicas, sensoriais ou mentais reduzidas ou falta de experiência e conhecimento se lhes tiver sido dada supervisão ou instruções relativas à utilização do aparelho de forma segura e compreendem os perigos envolvidos. As crianças não devem brincar com o aparelho. A limpeza e manutenção não devem ser efectuadas por crianças sem supervisão.
- Certifique-se de que a voltagem é a mesma que a indicada na placa de classificação do aparelho.
- Para evitar risco de choque eléctrico, certifique-se de que o aparelho está desconectado da tomada eléctrica antes de recolocá-lo, fazer manutenção ou limpá-lo.
- Não utilizar o aparelho se o cabo estiver danificado.

- Manter esta unidade e o seu cabo longe de fontes de calor, objectos cortantes, ou qualquer coisa que o possa danificar.
- Se o cabo de alimentação do aparelho estiver danificado, deve ser substituído pelo fabricante, pelo seu serviço pós-venda ou por pessoas com qualificação semelhante a fim de evitar perigos.
- Certifique-se de que o aparelho está desligado antes de o ligar à rede eléctrica.
- O aparelho de aquecimento não deve ser colocado imediatamente por baixo de uma tomada de corrente.
- Colocar sempre a unidade numa superfície estável e nivelada e utilizá-la em posição vertical.
- Não operar o aparelho em áreas onde gasolina, tinta ou outros líquidos inflamáveis possam ser utilizados ou armazenados.
- Apenas para uso interior.
- Para evitar um incêndio, não bloquear de forma alguma a entrada e saída de ar.
- Não tocar em superfícies quentes.
- Não inserir ou permitir que objectos estranhos entrem em qualquer abertura de ventilação ou de exaustão, pois isso causará choque eléctrico ou incêndio e danificará a unidade.
- Certifique-se sempre de que as suas mãos estão secas antes de ajustar qualquer interruptor ou de tocar na unidade.
- A principal causa de sobreaquecimento é devido a depósitos de pó ou resíduos na unidade. Certificar-se de que estes corpos estranhos são removidos regularmente. Desligue a unidade e limpe-a aspirando a entrada de ar e as grelhas.
- O aquecedor deve ser instalado de forma a que os interruptores e outros controlos não possam ser tocados por ninguém no banho ou no duche.
- Não utilizar a unidade com um temporizador, sistema de controlo remoto separado, ou qualquer outro dispositivo que ligue automaticamente a unidade, pois existe o risco de incêndio se a unidade for coberta ou colocada incorrectamente.
- Ao instalar o radiador no seu suporte, deve certificar-se de que o cabo eléctrico não entra em contacto com o invólucro metálico do radiador.
- O aparelho deve ser alimentado através de um dispositivo de corrente residual (disjuntor diferencial), a corrente nominal não deve ultrapassar 30 mA.
- Os meios para a desconexão com uma separação de contato em todos os pólos devem ser incorporados na fiação fixa de acordo com as regras de fiação.
- **ATENÇÃO:** Para evitar perigo devido ao reestabelecimento involuntário do corte térmico, este aparelho não deve ser alimentado através de um dispositivo de comutação externo, com um contador de tempo, ou conectado a um circuito que ligue e desligue regularmente com o aparelho.

## INSTALAÇÃO

O aparelho só deve ser utilizado e instalado numa posição fixa.

A instalação deve ser efectuada por um electricista qualificado para evitar qualquer perigo.

- **IMPORTANTE!** Certificar-se de que não há fios eléctricos ou outra instalação (canalização de água, por exemplo) perto dos locais onde os furos serão feitos. Certificar-se de fixar a unidade vertical e firmemente à parede.

- Este aparelho destina-se apenas à instalação e utilização em interiores.

- O aparelho não deve ser colocado directamente por cima de uma tomada eléctrica.

- Respeite as distâncias mínimas entre o aparelho e as paredes, o chão, mobiliário, cortinas, etc.

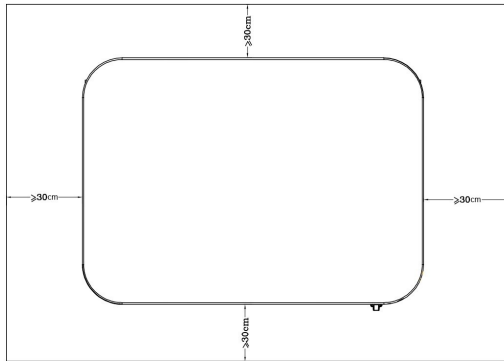

1. Certifique-se de manter a distância entre o aquecedor e o chão, parede e assim por diante pelo menos 30cm.
2. Não usar na casa de banho e não cobrir.
3. Siga a dimensão da broca para fazer dois furos no topo ( $\Phi 8$ ) na parede e coloque os parafusos de expansão nos furos.

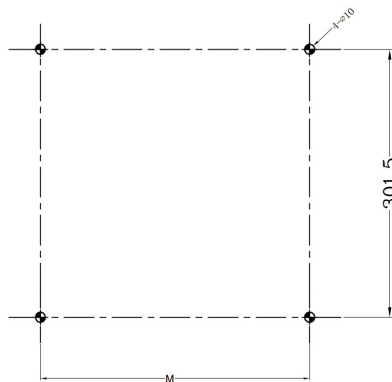

Modelo	Ceramic AC 1000	Ceramic AC 1500	Ceramic AC 1800
M(mm)	228	378	378

4. As estantes de gancho são pré-montadas na parte de trás do aquecedor, pendurar as duas estantes de gancho superiores nos parafusos. Marcar a posição dos dois ganchos inferiores na parede e retirar o aquecedor, depois fazer dois furos inferiores (Ø8) na parede e colocar a cobertura plástica dos parafusos de expansão nos furos.



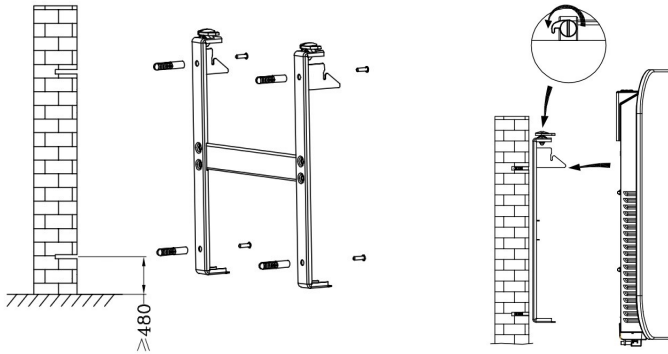

5. Pendurar o aquecedor na parede e colocar os parafusos de expansão nos dois furos do fundo.



**ATENÇÃO!** Antes de ligar o aparelho, certifique-se de que está devidamente fixado à parede. Se o aparelho não estiver nivelado, podem ocorrer problemas.

## FUNCIONAMENTO

### PAINEL DE CONTROLO

-  Botão ON / OFF
-  Ajuste da hora, dia e temperatura
-  Modo de selecção e programas
-  Aumentar
-  Diminuir

### ECRÃ LCD

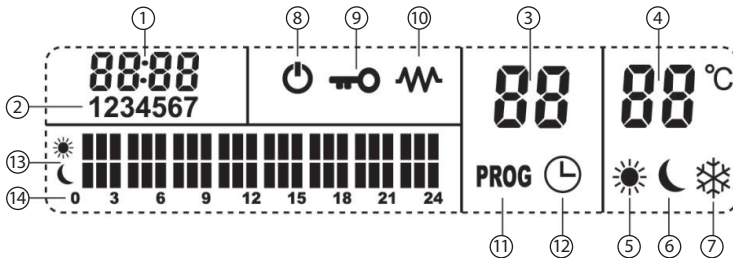

- |                             |                           |
|-----------------------------|---------------------------|
| 1 - Hora                    | 8 - ON/OFF                |
| 2 - Dia                     | 9 - Radiador de bloqueio  |
| 3 - Número do programa      | 10 - Aquecimento em       |
| 4 - Programa de temperatura | 11 - Selecção do programa |
| 5 - Modo Conforto           | 12 - Temporizador         |
| 6 - Modo económico          | 13 - Conteúdo do programa |
| 7 - Modo anti-gelada        | 14 - Escala temporal      |

O radiador tem três modos de funcionamento diferentes.

1. Um modo de funcionamento livre **F<sub>r</sub>** com temporizador de funcionamento.
2. Um modo de programa diário que inclui 9 programas diferentes de a **P 1** a **P 9** combinando dois modos de funcionamento: conforto ☀, económico 🌙 e geada ❄.
3. Um modo de programa semanal **RU**: atribuição de um horário diário para cada dia da semana.

### MODO DE FUNCIONAMENTO LIVRE

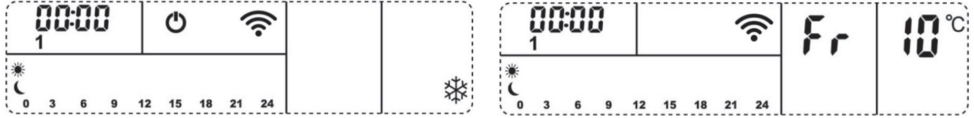

Prima , o ícone desaparece. O dispositivo está agora a funcionar livremente **F<sub>r</sub>**. Temperatura pré-definida de 10°C.

Nota : em caso de falha de energia, o tempo é reiniciado para 00:00 e o aquecedor reiniciará para a última função utilizada antes do corte.

### Ajuste do dia & hora

- Prima uma vez , as horas estão a piscar, depois utilize os botões e para ajustar as horas.
- Premir novamente , os minutos estão a piscar, depois utilizar os botões e para ajustar os minutos.
- Premir novamente , a data está a piscar, depois utilizar os botões e para seleccionar o dia : 1 - Segunda, 2 - Terça, 3 - Quarta, 4 - Quinta, 5 - Sexta, 6 - Sábado, 7 - Domingo.
- Premir uma vez mais para confirmar a sua escolha.

### Configuração da temperatura

- Pressionar uma vez ou . O mostrador de temperatura pisca.
- Pressionar novamente ou para ajustar a temperatura desejada. (a temperatura pode ser regulada num intervalo de 10°C a 35°C).
- Após 5 segundos sem acção nos botões ou , a temperatura é validada.

### Temporizador

Premir durante 3 segundos, o ícone aparece. Ao mesmo tempo, a indicação da hora pisca e passará às 00:00.

Usando os botões e escolher o tempo de funcionamento em passos de 30 minutos. Após 5 segundos sem acção sobre os botões ou , a duração é validada.

Uma vez que a duração do temporizador tenha expirado, o radiador entrará automaticamente em modo de espera .

Nota : Para sair do modo temporizador, premir 3 segundos. O radiador regressa ao modo de funcionamento livre **F<sub>r</sub>** .



### UTILIZAÇÃO DE DIFERENTES PROGRAMAS

#### Seleção do modo de funcionamento:

- RU** Programa semanal
- P 1\_P 9** Programa diário que se repete todos os dias
- F<sub>r</sub>** Modo de funcionamento livre

Aumentar ou diminuir a temperatura usando  ou .

1- Pressionar  uma vez.

2- Escolher **RU**, **F<sub>r</sub>**, **P 1~P9** utilizando  ou .



3- Pressionar  uma vez para confirmar a sua escolha.

NOTA : Se após a selecção do programa, nenhum botão do teclado for activado durante 5 segundos, a selecção é confirmada automaticamente.



### Programa diário

O radiador tem 9 programas diários que vão de **P 1** a **P9**.

Cada segmento, representando uma hora do dia, pode ser atribuído ao modo de funcionamento:







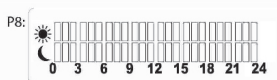
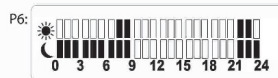
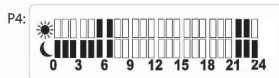
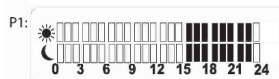

-  para o modo de conforto
-  para a modalidade económica
-  para modo de congelação

The 9 programs have been preset at the factory as follows:

-  para o modo de conforto, temperatura de 22°C.
-  para a modalidade económica, temperatura de 17°C.
-  para modo de congelação, temperatura de 7°C (este modo não pode ser personalizado).



### Personalização do modo de funcionamento conforto e económico

- 1- Sob P1 a P9 programa diário, pressione  durante 3 segundos, o indicador de temperatura pisca.
- 2- Use  ou , para ajustar a temperatura desejada para o modo conforto.
- 3- Pressione  para confirmar a sua selecção, o indicador de temperatura pisca.
- 4- Use  ou , para ajustar a temperatura desejada para o modo económico.
- 5- Premir  para confirmar a sua selecção.
- 6- O radiador volta automaticamente para o modo conforto .

NOTA :

Se o conforto e a temperatura ECO de um programa diário (P1 a P9) forem modificados, todos os programas diários e o conforto do modo automático e a temperatura ECO também serão modificados.

NOTA :

1. Se após a selecção do programa, nenhum botão do teclado for activado durante 5 segundos, a selecção é confirmada automaticamente.
2. Se um programa diário (P1 a P9) de conforto e temperatura ECO for modificado, todos os programas diários e o conforto do modo automático e temperatura ECO serão modificados.

### Personalização dos programas diários:

Prima , depois escolha o programa que deseja personalizar de **P 1** a **P 9**, utilizando  ou .





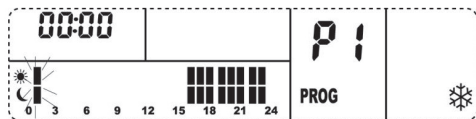

1- Pressione  durante 3 segundos, o ícone PROG aparece no visor.



2- O primeiro segmento  de 00:00 pisca.

Exemplo de programa P1 :



Use  para escolher como atribuir esta primeira hora.

(  para conforto ,  para modo económico  e  para modo de geada ).

3- Utilizar  ou  ir para a hora seguinte ou para a hora anterior do programa. Repetir 2 até que cada segmento do programa seja personalizado.

4- Pressione  durante 3 segundos para confirmar o seu programa. O ícone PROG desaparece no ecrã.

NOTA: O novo programa substitui o programa antigo na memória do dispositivo.

Se as suas configurações pessoais não o satisfizerem, pode voltar à predefinição de fábrica. Desligue o dispositivo usando o interruptor na parte de trás do dispositivo. Em seguida, prima  durante 7 segundos para reiniciar o dispositivo.

A personalização dos programas diários deve ser feita antes da programação semanal.

### Programação semanal

1- Pressione  uma vez.

2- Escolher a programação diária **AU**, utilizando  ou .

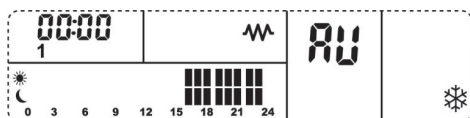

3- Pressione  uma vez para confirmar a sua escolha.

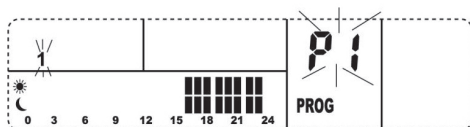

4- Pressione  durante 3 segundos, o ícone PROG aparece no visor.

5- O número 1, representando MONDAY e o programa correspondente P1 irá piscar.



6- Atribuir utilizando  ou  um programa (de P1 a P9) para segunda-feira. Confirme a sua selecção com . O número 2 irá piscar - representando a terça-feira. Repita até ter atribuído um programa para cada dia da semana (1 - a 7 segunda-feira - domingo)

7- Depois de atribuir o programa ao 7-Domingo, confirme a sua selecção com . O ícone PROG desaparece no visor.

8- The heater then operates in accordance with the new weekly program that you have just created.

## FUNÇÃO JANELA ABERTA

O seu aquecedor tem uma função de janela aberta. Se abrir amplamente uma janela no espaço onde se encontra o aquecedor e a temperatura cair mais de 2°C em 5 minutos, um sensor detectará a queda brusca da temperatura. O aquecedor desliga-se automaticamente e o símbolo **F0** cintila no seu ecrã. O aquecedor voltará ao modo anterior, se a temperatura ambiente subir mais de 2°C em 5 minutos. No entanto, pode reiniciar manualmente o aquecedor premindo . O símbolo **F0** desaparece do ecrã.

Em modo de espera, premir e manter premido o botão  durante 5 segundos, o símbolo **F0** aparece no ecrã e o símbolo **0F** cintila no ecrã. **0F** indica “função não em funcionamento”.



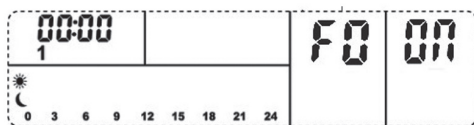

Premir  ou  para mudar o símbolo de **0F** a **0N**, **0n** indica “função em funcionamento”.



## BLOQUEIO

O dispositivo ficará automaticamente bloqueado se não for utilizado durante 30 segundos.



Para desbloquear o radiador em qualquer altura (um ícone de tecla será visível no painel médio esquerdo do visor) prima  e  ao mesmo tempo.

## CALIBRAÇÃO DA TEMPERATURA

Em modo de espera, premir e manter premido o botão  durante 10 segundos:

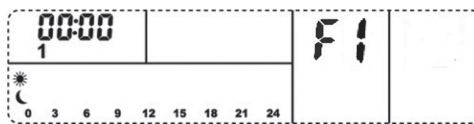
Primeiro, o ecrã sairá F1, note que é utilizado para o ajuste da temperatura do sensor interno do aquecedor, por favor nunca o ajuste.



Segundo, depois de F1 sair, prima o botão  para mudar para F2, depois prima  ou  botão para mudar a “calibração da temperatura” de -5°C para 5°C.

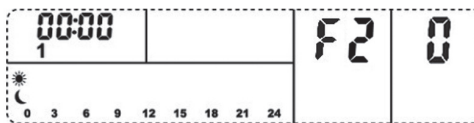



**DISPOSITIVO DE SEGURANÇA CONTRA SOBREAQUECIMENTO**

O radiador está equipado com um dispositivo de segurança que desliga o aquecedor em caso de sobreaquecimento. No caso de o aquecedor parar de funcionar, desligar o aquecedor e efectuar uma inspecção nas entradas e saídas de ar para ver se estão entupidos. Esperar pelo menos 5 minutos para que o sistema de protecção seja reiniciado antes de reiniciar o aquecedor. Se o aquecedor não funcionar ou se o dispositivo de segurança for desligado novamente, levar o dispositivo ao centro de assistência mais próximo para ser considerado ou reparado.

**LIMPEZA E MANUTENÇÃO**

- Desligue sempre o aparelho e retire o cabo da tomada antes de limpá-lo.
- Deixe o aquecedor arrefecer completamente.
- Nunca mergulhe em água ou outro líquido. Não permita que a água entre no aparelho.
- Limpar a unidade pelo menos uma vez por ano com um aspirador para remover qualquer poeira da acumulação de pó.
- Limpe o aquecedor com um pano macio e úmido.
- Não use materiais químicos para a limpeza de seu aquecedor.
- Limpe o aparelho regularmente.

**GARANTIA**

As condições desta garantia são concedidos, além de todas as garantias implícitas, outros direitos e recursos em relação ao produto que o consumidor tem nos termos da lei do Comércio e leis similares do estado ou território. O comprador original deste produto tem a seguinte garantia, sujeito às seguintes condições. Este produto é garantido por um período de 3 anos em caso de “erro de fabricação”, o produto deve ser devolvido para a loja onde foi comprado e substituído gratuitamente ou reembolsar o valor. A fim de obter uma troca ou reembolso, você deverá apresentar o comprovante de compra para o vendedor.

**RETIRADA DE APARELHOS USADOS**

Directiva Europeia 2012/19/EC sobre Resíduos de Equipamentos Eléctricos e Electrónicos (REEE), exige que os aparelhos usados não sejam eliminados no fluxo normal de resíduos urbanos. Os aparelhos desactualizados devem ser recolhidos separadamente, a fim de otimizar a taxa de recuperação e reciclagem de materiais utilizados na sua preparação e reduzir o impacto sobre a saúde humana e o meio ambiente.

## REQUISITOS DE INFORMAÇÃO PARA AQUECEDORES DE AMBIENTE LOCAL ELÉTRICOS

Identificador(es) del modelo:		CERAMIC A			
Elemento	Símbolo	Valor	Unidade	Elemento	Unidade
Potência calorífica <b>CERAMIC AC 1000</b>				Tipo de potência calorífica, apenas para os aquecedores de ambiente local elétricos de acumulação (selecionar uma opção)	<b>N/A</b>
Potência calorífica nominal	Pnom	1.0	kW	Comando manual da carga térmica, com termóstato integrado	[não]
Potência calorífica mínima (indicativa)	Pmin		kW	Comando manual da carga térmica, com retroação da temperatura interior e/ou exterior	[não]
Potência calorífica contínua máxima	Pmax,c		kW	Comando eletrónico da carga térmica, com retroação da temperatura interior e/ou exterior	[não]
<b>Consumo de eletricidade auxiliar</b>				Potência calorífica com ventilador	[não]
À potência calorífica nominal	elmax	N/A	kW	<b>Tipo de potência calorífica/comando da temperatura interior (selecionar uma opção)</b>	
À potência calorífica mínima	elmin	N/A	kW	Potência calorífica numa fase única, sem comando da temperatura interior	[não]
Em estado de vigília	eISB	N/A	kW	Em duas ou mais fases manuais, sem comando da temperatura interior	[não]
Potência calorífica <b>CERAMIC AC 1500</b>				Com comando da temperatura interior por termóstato mecânico	[não]
Potência calorífica nominal	Pnom	1.5	kW	Com comando eletrónico da temperatura interior	[não]
Potência calorífica mínima (indicativa)	Pmin		kW	Com comando eletrónico da temperatura interior e temporizador diário	[não]
Potência calorífica contínua máxima	Pmax,c		kW	Com comando eletrónico da temperatura interior e temporizador semanal	[sim]
<b>Consumo de eletricidade auxiliar</b>				<b>Outras opções de comando (seleção múltipla possível)</b>	<b>N/A</b>
À potência calorífica nominal	elmax	N/A	kW	Comando da temperatura interior, com deteção de presença	[não]
À potência calorífica mínima	elmin	N/A	kW	Comando da temperatura interior, com deteção de janelas abertas	[sim]
Em estado de vigília	eISB	N/A	kW	Com opção de comando à distância	[sim]
Potência calorífica <b>CERAMIC AC 1800</b>				Com comando de arranque adaptativo	[não]
Potência calorífica nominal	Pnom	1.8	kW	Com limitação do tempo de funcionamento	[não]
Potência calorífica mínima (indicativa)	Pmin		kW	Com sensor de corpo negro	[não]
Potência calorífica contínua máxima	Pmax,c		kW		
<b>Consumo de eletricidade auxiliar</b>					
À potência calorífica nominal	elmax	N/A	kW		
À potência calorífica mínima	elmin	N/A	kW		
Em estado de vigília	eISB	N/A	kW		
Elementos de contacto		<b>CLIMACITY S.L.</b> C. Torrox, 2 - 5 · 28041 Madrid (ESPAÑA) - tel. +34 91 392 05 09			

Leggere attentamente queste istruzioni prima dell'uso,  
e conservare per future consultazioni

## SPECIFICHE TECNICHE

Modello	Alimentazione	Frequenza	Potenza	Clase
CERAMIC AC 1000	230V~	50 Hz	1000W	II
CERAMIC AC 1500	230V~	50 Hz	1500W	II
CERAMIC AC 1800	230V~	50 Hz	1800W	II

## AVVERTENZE DI SICUREZZA



**ATTENZIONE:** Alcune parti dell'apparecchio possono diventare molto calde e provocare ustioni. È necessario prestare particolare attenzione in presenza di bambini o persone vulnerabili.



**ATTENZIONE:** Al fine di evitare il surriscaldamento non coprire mai l'apparecchio.

- Tenere lontani dall'apparecchio i bambini di età inferiore a 3 anni, a meno che costantemente sorvegliati.
- Ai bambini di età compresa tra 3 e 8 anni è consentito solo accendere/spegnere l'apparecchio, purché questo sia collocato o installato nell'abituale posizione operativa ed essi siano attentamente sorvegliati e istruiti su come utilizzare in modo sicuro l'apparecchio e sui pericoli che ciò comporta. Ai bambini di età compresa tra 3 e 8 anni non è consentito inserire la spina, regolare e pulire l'apparecchio o eseguirne la manutenzione.
- L'apparecchio può essere utilizzato da bambini di età non inferiore ad 8 anni e da persone con ridotte capacità psico-fisico-sensoriali o con esperienza e conoscenze insufficienti, purché attentamente sorvegliate o istruite su come utilizzare in modo sicuro l'apparecchio e sui pericoli che ciò comporta. Assicurarsi che i bambini non giochino con l'apparecchio. Pulizia e manutenzione da parte dell'utente non devono essere effettuate da bambini, a meno che non siano sorvegliati.
- Assicurarsi che la tensione sia la stessa di quella indicata sulla targhetta dell'apparecchio.
- Per evitare il rischio di scossa elettrica, assicurarsi che l'apparecchio sia scollegato dalla presa elettrica prima di spostarlo, ripararlo o pulirlo.
- Non utilizzare l'apparecchio se il cavo è danneggiato.

- Tenere l'apparecchio e il suo cavo lontano da fonti di calore, da oggetti appuntiti o da qualsiasi cosa che possa danneggiarlo.
- Assicurarsi che l'apparecchio sia spento prima di collegarlo alla rete elettrica.
- Se il cavo elettrico è danneggiato, deve essere rimpiazzato dal fabbricante, il suo agente di servizio o persone qualificate col fine di evitare un pericolo.
- L'apparecchio non deve essere situato sotto ad una presa di corrente.
- Posizionare sempre l'apparecchio su una superficie stabile e piana e utilizzarlo in posizione verticale.
- Non mettere in funzione l'apparecchio in aree in cui possono essere utilizzati o conservati benzina, vernice o altri liquidi infiammabili.
- Solo per uso interno.
- Per prevenire un incendio, non bloccare in alcun modo l'ingresso e l'uscita dell'aria.
- Non toccare le superfici calde.
- Non inserire o lasciare entrare oggetti estranei in qualsiasi apertura di ventilazione o di scarico in quanto ciò provocherebbe scosse elettriche o incendi e danneggerebbe l'unità.
- Assicurarsi sempre che le mani siano asciutte prima di regolare qualsiasi interruttore o di toccare l'unità.
- La causa principale del surriscaldamento è dovuta a depositi di polvere o residui nell'unità. Assicurarsi che questi corpi estranei siano rimossi regolarmente. Scollegare l'unità dalla rete e pulirla aspirando l'ingresso dell'aria e le griglie.
- Il riscaldatore deve essere installato in modo che gli interruttori e gli altri comandi non possano essere toccati da nessuno nella vasca da bagno o nella doccia.
- Non utilizzare l'unità con un timer, un sistema di controllo remoto separato o qualsiasi altro dispositivo che accenda automaticamente l'unità, in quanto vi è il rischio di incendio se l'unità è coperta o posizionata in modo non corretto.
- Quando si installa il radiatore sul suo supporto, è necessario assicurarsi che il cavo elettrico non venga a contatto con l'involucro metallico del radiatore.
- L'apparecchio deve essere alimentato tramite un interruttore differenziale (RCD) con corrente operativa residua nominale non superiore a 30mA.
- I mezzi di disconnessione dall'alimentazione principale tramite un interruttore con la separazione dei contatti su tutti i poli devono essere incorporati nel cablaggio fisso in conformità alle norme relative.
- PRECAUZIONE: Col fine di evitare un pericolo dovuto alla riaccensione involontaria dell'interruzione termica, questo apparato non deve essere alimentato attraverso un dispositivo di commutazione esterno, come un contatore a tempi, o connesso ad un circuito che accenda e spenga regolarmente l'apparecchio.

## INSTALLAZIONE

L'apparecchio deve essere utilizzato e installato solo in posizione fissa.

L'installazione deve essere eseguita da un elettricista qualificato per evitare qualsiasi pericolo.

- **IMPORTANTE!** Accertarsi che non vi siano cavi elettrici o altre installazioni (ad esempio tubi dell'acqua) in prossimità dei punti in cui verranno praticati i fori. Assicurarsi di fissare l'unità verticalmente e saldamente alla parete.

- Questo apparecchio è destinato esclusivamente all'installazione e all'uso in ambienti interni.

- L'apparecchio non deve essere collocato direttamente sotto una presa di corrente.

- Rispettare le distanze minime tra l'apparecchio e le pareti, il pavimento, i mobili, le tende, ecc.

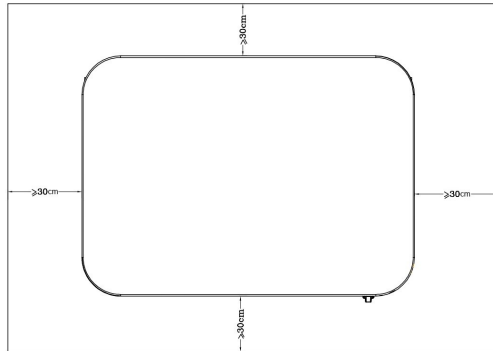

1. Assicurarsi di mantenere la distanza tra il riscaldatore e il pavimento, la parete e così via almeno 30cm.

2. Non usare in bagno e non coprire.

3. Seguire le dimensioni del trapano per praticare due fori in alto ( $\varnothing 8$ ) sulla parete e inserire le viti ad espansione nei fori.

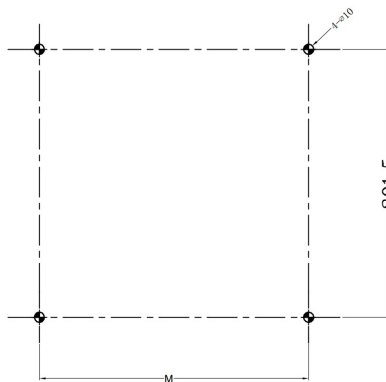

Modello	Ceramic AC 1000	Ceramic AC 1500	Ceramic AC 1800
M(mm)	228	378	378



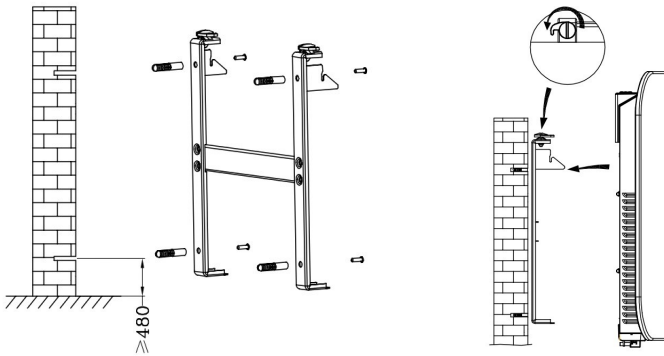

- 4.. I porta ganci sono premontati sul retro del riscaldatore, appendere i due porta ganci superiori alle viti. 5. Segnare la posizione dei due porta ganci inferiori sulla parete e togliere il riscaldatore, quindi praticare due fori inferiori ( $\Phi 8$ ) sulla parete e inserire il coperchio di plastica delle viti a espansione nei fori. 5. Appendere il riscaldatore alla parete e inserire le viti a espansione nei due fori inferiori.



ATTENZIONE ! Prima di avviare l'apparecchio, assicurarsi che sia fissato correttamente alla parete. Se l'apparecchio non è in piano, possono verificarsi problemi.

## FUNZIONAMENTO

### PANNELLO DI CONTROLLO

-  Pulsante ON / OFF
-  Impostazione dell'ora, del giorno e della temperatura
-  Selezione del modo e dei programmi
-  Aumentare
-  Diminuire

### SCHERMO LCD

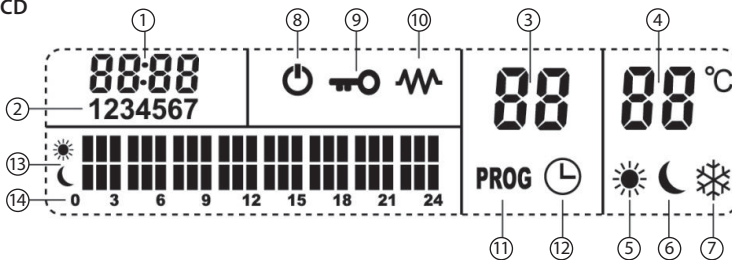



- |                         |                              |
|-------------------------|------------------------------|
| 1 - Ora                 | 8 - ON/OFF                   |
| 2 - Giorno              | 9 - Bloccaggio               |
| 3 - Numero di programma | 10 - Riscaldamento           |
| 4 - Programma di tempra | 11 - Selezione del programma |
| 5 - Modalità comfort    | 12 - Timer                   |
| 6 - Modalità economico  | 13 - Contenuto del programma |
| 7 - Modalità antigelo   | 14 - Scala ore               |

Il radiatore ha tre diverse modalità di funzionamento.

1. Una modalità di funzionamento libero **F<sub>r</sub>** con timer di funzionamento.
2. Un modo di programma giornaliero che comprende 9 diversi programmi da **P<sub>1</sub>** a **P<sub>9</sub>** che combinano due modi di funzionamento: comfort ☀, economico 🌙 e antigelo ❄.
3. Un modo di programmazione settimanale **RU**: assegnazione di un programma giornaliero per ogni giorno della settimana.

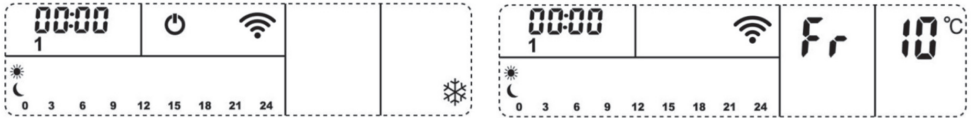









### MODO DI FUNZIONAMENTO LIBERO









Premere , l'icona  scompare. Il dispositivo è ora libero **F<sub>r</sub>**. Temperatura preimpostata di 10°C.

Nota : in caso di mancanza di corrente, l'ora viene riportata a 00:00 e il riscaldatore si riavvia all'ultima funzione utilizzata prima del taglio.



### Regolazione del giorno e dell'ora





- Premere una volta , le ore lampeggiano, quindi utilizzare i tasti  e  per regolare le ore.
- Premere di nuovo , i minuti lampeggiano, poi usare i tasti  e  per regolare i minuti.
- Premere di nuovo , la data lampeggia, poi usare i tasti  e  per selezionare il giorno : 1- Lunedì, 2 - Martedì, 3 - Mercoledì, 4 - Giovedì, 5 - Venerdì, 6 - Sabato, 7 - Domenica.
- Premere , ancora una volta per confermare la scelta.

### Impostazione della temperatura

- Premere una volta  ou . L'indicazione della temperatura lampeggia.
- Premere di nuovo  ou  per regolare la temperatura desiderata. (la temperatura può essere impostata in un campo da 10°C a 35°C).
- Dopo 5 secondi senza azione dei tasti  ou , la temperatura viene convalidata.

### Timer

Premere  per 3 secondi, appare l'icona . Allo stesso tempo l'indicazione dell'ora lampeggia e passerà alle 00:00.

Con i tasti  e  scegliere il tempo di funzionamento a passi di 30 minuti. Dopo 5 secondi senza agire sui tasti  o , la durata viene convalidata.

Una volta scaduta la durata del timer, il radiatore va automaticamente in standby .





Nota : Per uscire dalla modalità timer, premere  3 secondi. Il radiatore ritorna in modalità di funzionamento libero **F<sub>r</sub>**.

### UTILIZZO DI DIVERSI PROGRAMMI

**Selezione del modo di funzionamento:**

- RU** Programma settimanale
- P<sub>1</sub>~P<sub>9</sub>** Programma giornaliero che si ripete ogni giorno
- F<sub>r</sub>** Modo di funzionamento libero

Aumentare o diminuire la temperatura utilizzando  o .



- 1- Premere  una volta.
- 2- Scegliere **RU**, **F**, **P1**, **P9** utilizzando  o .
- 3- Premere una volta  per confermare la scelta.

NOTA: Se dopo aver selezionato il programma, nessun tasto della tastiera viene attivato per 5 secondi, la selezione viene confermata automaticamente.



### Programma giornaliero

Il radiatore ha 9 programmi giornalieri che vanno da **P1** a **P9**.

Ogni segmento, che rappresenta un'ora del giorno, può essere assegnato alla modalità di funzionamento:

-  per la modalità comfort
-  per la modalità economica
-  per la modalità antigelo

The 9 programs have been preset at the factory as follows:

-  per la modalità comfort, temperatura di 22°C.
-  per la modalità economica, temperatura di 17°C.
-  per la modalità antigelo, temperatura di 7°C (questo modo non può essere personalizzato!).

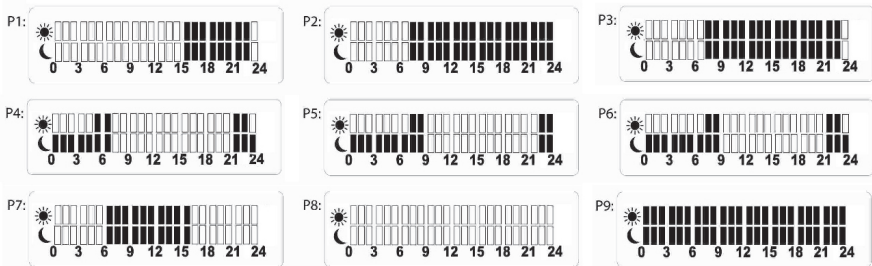



### Personalizzazione del modo operativo comfort ed economico

1- Sotto il programma giornaliero da P1 a P9, premere  per 3 secondi, l'indicatore della temperatura lampeggia.

2- Utilizzare  o  per regolare la temperatura desiderata per il modo comfort.

3- Premere , per confermare la selezione, l'indicatore della temperatura lampeggia.

4- Utilizzare  o  per regolare la temperatura desiderata per il modo economico.

5- Premere , per confermare la selezione.

6- Il radiatore ritorna automaticamente alla modalità comfort .

NOTA :

Se la temperatura comfort e la temperatura ECO di un programma giornaliero (da P1 a P9) vengono modificate, verranno modificati anche tutti i programmi giornalieri e la temperatura comfort e la temperatura ECO della modalità automatica.

NOTA :



1. Se dopo aver selezionato il programma, nessun tasto della tastiera viene attivato per 5 secondi, la selezione viene confermata automaticamente.

2. Se un programma giornaliero (da P1 a P9) comfort e temperatura ECO viene modificato, tutti i programmi giornalieri e la temperatura comfort ed ECO della modalità automatica verranno modificati.





### Personalizzazione dei programmi giornalieri:

Premere , e scegliere il programma che si desidera personalizzare da **P1** a **P9**, utilizzando  o .

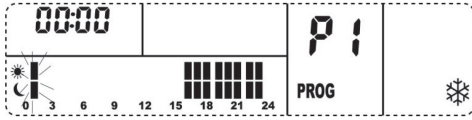

- 1- Premere  per 3 secondi, sul display appare l'icona PROG.
- 2- Il primo segmento  di 00:00 lampeggia.

Esempio di programma P1 :



Usare  per scegliere come assegnare questa prima ora.

( per il comfort ,  per il modo economico  e  per il modo gelo 

3- Utilizzare  o  per passare all'ora successiva o precedente del programma. Ripetere 2 fino a personalizzare ogni segmento del programma.





- 4- Premere  per 3 secondi per confermare il programma. L'icona PROG scompare sullo schermo.

NOTA: Il nuovo programma sostituisce il vecchio programma nella memoria del dispositivo.

Se le vostre impostazioni personali non vi soddisfano, potete tornare alle impostazioni di fabbrica. Spegner l'apparecchio con l'interruttore sul retro dell'apparecchio. Poi premere il tasto  per 7 secondi per resettare il dispositivo.

La personalizzazione dei programmi giornalieri deve essere effettuata prima della programmazione settimanale.



### Programmazione settimanale:

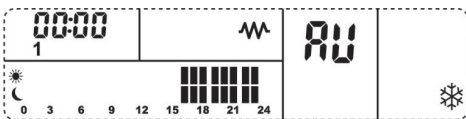

- 1- Premere  una volta.
- 2- Scegliere il programma giornaliero **RU** utilizzando  o .
- 3- Premere  una volta per confermare la scelta

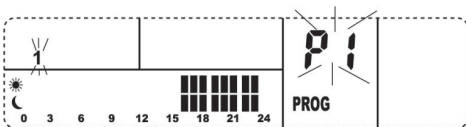

- 4- Premere  per 3 secondi, sul display appare l'icona PROG.
- 5- Il numero 1, che rappresenta il LUNEDÌ e il programma corrispondente P1 lampeggiano.





6- Assegnare un programma (da P1 a P9) per il lunedì utilizzando  o . Confermare la selezione con . Il numero 2 lampeggerà - che rappresenta il martedì. Ripetere fino ad aver assegnato un programma per ogni giorno della settimana (da 1 - a 7 Lunedì-Domenica)

7- Dopo aver assegnato il programma a 7-Domenica, confermare la selezione con utilizzando  o . L'icona PROG scompare sul display.

8- Il riscaldatore funziona quindi secondo il nuovo programma settimanale appena creato.

### FUNZIONE FINESTRA APERTA

Il vostro riscaldatore ha una funzione di finestra aperta. Se si apre ampiamente una finestra nello spazio in cui si trova il riscaldatore e la temperatura scende di oltre 2°C in 5 minuti, un sensore rileverà il brusco calo di temperatura. Il riscaldatore si spegne automaticamente e il simbolo **FO** lampeggia sullo schermo. Il riscaldatore tornerà alla modalità precedente se la temperatura ambiente aumenta di più di 2°C in 5 minuti. Tuttavia, è possibile riavviare manualmente il riscaldatore premendo il pulsante . Il simbolo **FO** scompare dallo schermo.

In modalità standby, premere il pulsante  per 5 secondi, il simbolo **FO** appare sullo schermo e il simbolo **OF** lampeggia sullo schermo. **OF** indica "funzione non in funzione".

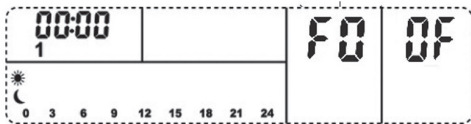

Premere il pulsante  o  per cambiare il simbolo da **OF** a **ON**, **ON** indica "funzione in corso".

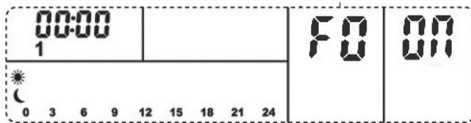

### BLOCCO

Il dispositivo si blocca automaticamente se è lasciato incustodito per 30 secondi.



Per sbloccare il radiatore in qualsiasi momento (un'icona a forma di chiave sarà visibile nel riquadro centrale sinistro del display) premere simultaneamente  e .

### CALIBRAZIONE DELLA TEMPERATURA

In modalità standby, tenere premuto il pulsante  per 10 secondi.

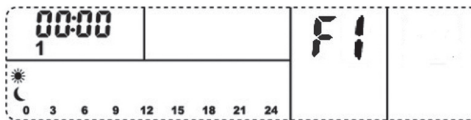
In primo luogo, sullo schermo apparirà F1, si prega di notare che questo viene utilizzato per la regolazione della temperatura del sensore interno del riscaldatore, per favore non regolarlo mai.



In secondo luogo, dopo l'uscita di F1, premere il pulsante  per passare a F2, poi premere  o  il pulsante per cambiare la "calibrazione della temperatura" da -5°C a 5°C.

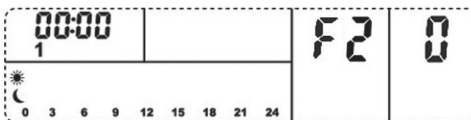

**DISPOSITIVO DI SICUREZZA ANTI SURRISCALDAMENTO**

Il radiatore è dotato di un dispositivo di sicurezza che spegne il riscaldatore in caso di surriscaldamento. Nel caso in cui il radiatore smetta di funzionare, spegnere il radiatore ed effettuare un'ispezione agli ingressi e alle prese d'aria per verificare se sono ostruiti. Attendere almeno 5 minuti in modo che il sistema di protezione venga resettato prima di riavviare il riscaldatore. Se il riscaldatore non funziona o se il dispositivo di sicurezza si spegne di nuovo, portare il dispositivo al centro di assistenza più vicino per un esame o una riparazione.

**PULIZIA E MANTENIMENTO**

- Spegnere sempre l'apparecchio e scollegare il cavo di alimentazione prima di effettuare la pulizia.
- Lasciare raffreddare completamente prima di pulire.
- Non immergere mai il radiatore in acqua o altri liquidi. Non lasciare che l'acqua penetri nell'apparecchio.
- Pulire l'unità almeno una volta all'anno con un aspirapolvere per rimuovere l'accumulo di polvere.
- Pulire il riscaldatore con un panno morbido e umido. Non utilizzare materiali chimici per la pulizia del riscaldatore.
- Pulire regolarmente l'apparecchio.

**GARANZIA**

Le condizioni presenti in questa garanzia si concedono in aggiunta a tutte le garanzie implicite, altri diritti e risorse in relazione col prodotto che il consumatore ha sotto la Legge di Pratica di Commercio e leggi simili statali e territoriali. Il compratore originale di questo prodotto dispone della seguente garanzia ed è soggetto alle seguenti condizioni. Questo prodotto è garantito per un periodo di 3 anni, in caso di "errore di fabbricazione" il prodotto dovrà essere restituito al negozio dove venne comprato per essere sostituito di forma gratuita o per ottenere il rimborso dell'importo. Col fine di ottenere una sostituzione del prodotto o un rimborso, è necessario presentare una prova di acquisto valida al venditore.

**SMALTIMENTO DEGLI APPARATI DOMESTICI USATI**

La direttiva Europea 2012/19/EC sullo smaltimento di Appareti Elettrici ed Elettronici (RAEE), esige che gli apparecchi domestici usati non si gettino nel flusso normale dei residui municipali. Gli apparecchi usati devono essere raccolti a parte, al fine di ottimizzare il tasso di recupero ed il riciclaggio dei materiali che entrano nella sua composizione e ridurre l'impatto sulla salute umana e l'ecosistema.

## INFORMAZIONI OBBLIGATORIE PER GLI APPARECCHI PER IL RISCALDAMENTO D'AMBIENTE LOCALE ELETTRICI

Identificativo del modello:		CERAMIC A			
Dato	Simbolo	Valore	Unitá	Dato	Unitá
Potenza termica <b>CERAMIC AC 1000</b>				Tipo di potenza termica, solo per gli apparecchi per il riscaldamento d'ambiente locale elettrici ad accumulo (indicare una sola opzione)	
Potenza termica nominale	Pnom	1.0	kW	controllo manuale del carico termico, con termostato integrato	[no]
Potenza termica minima (indicativa)	Pmin		kW	controllo manuale del carico termico con riscontro della temperatura ambiente e/o esterna	[no]
Massima potenza termica continua	Pmax,c		kW	controllo elettronico del carico termico con riscontro della temperatura ambiente e/o esterna	[no]
<b>Consumo ausiliario di energia elettrica</b>				potenza termica assistita da ventilatore	
Alla potenza termica nominale	elmax	N/A	kW	<b>Tipo di potenza termica/controllo della temperatura ambiente (indicare una sola opzione)</b>	
Alla potenza termica minima	elmin	N/A	kW	potenza termica a fase unica senza controllo della temperatura ambiente	[no]
In modo stand-by	eISB	N/A	kW	due o piú fasi manuali senza controllo della temperatura ambiente	[no]
Potenza termica <b>CERAMIC AC 1500</b>				con controllo della temperatura ambiente tramite termostato meccanico	
Potenza termica nominale	Pnom	1.5	kW	con controllo elettronico della temperatura ambiente	[no]
Potenza termica minima (indicativa)	Pmin		kW	con controllo elettronico della temperatura ambiente e temporizzatore giornaliero	[no]
Massima potenza termica continua	Pmax,c		kW	con controllo elettronico della temperatura ambiente e temporizzatore settimanale	[so]
<b>Consumo ausiliario di energia elettrica</b>				<b>Altre opzioni di controllo (è possibile selezionare piú opzioni)</b>	
Alla potenza termica nominale	elmax	N/A	kW	controllo della temperatura ambiente con rilevamento di presenza	[no]
Alla potenza termica minima	elmin	N/A	kW	controllo della temperatura ambiente con rilevamento di finestre aperte	[si]
In modo stand-by	eISB	N/A	kW	con opzione di controllo a distanza	[si]
Potenza termica <b>CERAMIC AC 1800</b>				con controllo di avviamento adattabile	
Potenza termica nominale	Pnom	1.8	kW	con limitazione del tempo di funzionamento	[no]
Potenza termica minima (indicativa)	Pmin		kW	con termometro a globo nero	[no]
Massima potenza termica continua	Pmax,c		kW		
<b>Consumo ausiliario di energia elettrica</b>					
Alla potenza termica nominale	elmax	N/A	kW		
Alla potenza termica minima	elmin	N/A	kW		
In modo stand-by	eISB	N/A	kW		
Contatti		<b>CLIMACITY S.L.</b> C. Torrox, 2 - 5 · 28041 Madrid (ESPAÑA) - tel. +34 91 392 05 09			

Lesen sie diese wichtigen anweisungen sorgfältig durch  
und bewahren sie sie gut auf.

## TECHNISCHE DATEN

Modell	Spannung	Frequenz	Pleistung	Clase
CERAMIC AC 1000	230V~	50 Hz	1000W	II
CERAMIC AC 1500	230V~	50 Hz	1500W	II
CERAMIC AC 1800	230V~	50 Hz	1800W	II

## SICHERHEITSANWEISUNGEN



**VORSICHT** : Einige Teile des Produktes können sehr heiß werden und Verbrennungen verursachen. Besondere Vorsicht ist geboten, wenn Kinder und schutzbedürftige Personen anwesend sind.



**VORSICHT: WARNUNG**: Um eine Überhitzung zu verhindern, das Gerät darf nicht abgedeckt werden.

- Das Gerät nicht in Reichweite von Kindern unter 3 Jahren aufstellen, es sei denn, sie werden ständig beaufsichtigt.
- Kinder zwischen 3 und 8 Jahren dürfen das Gerät nur dann ein- und ausschalten, wenn es an seinem üblichen Betriebsplatz aufgestellt und installiert ist, und wenn sie beaufsichtigt sowie im sicheren Gebrauch des Gerätes geschult werden, und sich der damit verbundenen Gefahren bewusst sind. Kinder zwischen 3 und 8 Jahren dürfen nicht den Gerätestecker einstecken, das Gerät einstellen und reinigen bzw. Wartungsarbeiten daran ausführen.
- Das Gerät darf von Kindern ab 8 Jahren und von Personen mit eingeschränkten Kenntnissen hinsichtlich seiner Handhabung bzw. einer Beeinträchtigung der Sinnesorgane verwendet werden, unter der Voraussetzung, sie werden beaufsichtigt und im sicheren Gebrauch des Gerätes geschult, und sind sich der damit verbundenen Gefahren bewusst. Sorgen Sie dafür, dass Kinder nicht mit dem Gerät spielen. Die Reinigung und Wartung durch den Benutzer darf nicht von Kindern durchgeführt werden, es sei denn, sie werden beaufsichtigt.
- Stellen Sie sicher, dass die Spannung mit der auf dem Typenschild des Geräts angegebenen Spannung übereinstimmt.
- Um die Gefahr von Stromschlägen zu vermeiden, Vor jedem Reinigungs- oder Wartungsverfahren immer den Stecker aus der Netzsteckdose ziehen.
- Verwenden Sie das Gerät nicht, wenn das Kabel beschädigt ist.
- Halten Sie dieses Gerät und sein Kabel von Wärmequellen, scharfen Gegenständen und allem fern, was es beschädigen könnte.
- Stellen Sie sicher, das Gerät ausgeschaltet ist, bevor Sie es am Stromnetz anschließen.

## DE

- Wenn das Stromkabel beschädigt ist, muss es vom Hersteller oder dem technischen Kundendienst oder einem Fachtechniker ersetzt werden, um sämtliche Risiken zu vermeiden.
- Das Gerät nicht direkt unter einer Steckdose montieren.
- Stellen Sie das Gerät immer auf eine stabile, ebene Oberfläche und benutzen Sie es in aufrechter Position.
- Betreiben Sie das Gerät nicht in Bereichen, in denen Benzin, Farbe oder andere entzündliche Flüssigkeiten verwendet oder gelagert werden können.
- Nur für den Gebrauch in Innenräumen.
- Um einen Brand zu verhindern, dürfen der Lufteinlass und -auslass in keiner Weise blockiert werden.
- Berühren Sie keine heißen Oberflächen.
- Stecken Sie keine Fremdkörper in die Belüftungs- oder Abluftöffnungen und lassen Sie auch keine Fremdkörper in diese Öffnungen eindringen, da dies einen elektrischen Schlag oder Brand verursachen und das Gerät beschädigen kann.
- Vergewissern Sie sich immer, dass Ihre Hände trocken sind, bevor Sie einen Schalter einstellen oder das Gerät berühren.
- Die Hauptursache für Überhitzung ist auf Staubablagerungen oder Rückstände im Gerät zurückzuführen. Stellen Sie sicher, dass diese Fremdkörper regelmäßig entfernt werden. Trennen Sie das Gerät vom Netz und reinigen Sie es, indem Sie den Lufteinlass und die Gitter absaugen.
- Die Heizung muss so installiert werden, dass Schalter und andere Bedienelemente von niemandem in der Badewanne oder Dusche berührt werden können.
- Verwenden Sie das Gerät nicht mit einer Zeitschaltuhr, einem separaten Fernbedienungssystem oder einer anderen Vorrichtung, die das Gerät automatisch einschaltet, da Brandgefahr besteht, wenn das Gerät abgedeckt oder falsch aufgestellt wird.
- Wenn Sie den Heizkörper auf seiner Halterung installieren, müssen Sie darauf achten, dass das elektrische Kabel nicht mit dem Metallgehäuse des Heizkörpers in Berührung kommt.
- Die Energieversorgung des Geräts muss über einen Fehlerstrom-Schutzschalter geführt werden, der für einen Nennfehlerstrom von maximal 30 mA ausgelegt ist.
- Ein Hauptschalter oder andere Hilfsmittel zur Abschaltung, die über eine Kontakttrennung bei allen Polen verfügen, müssen in die fest angebrachte Verkabelung in Übereinstimmung mit der entsprechenden örtlichen und nationalen Gesetzgebung eingebaut werden.
- **ACHTUNG:** Um eine Gefährdung durch unbeabsichtigtes Rücksetzen der berhitzungssicherungs funktion zu vermeiden, darf dieses Gerät nicht durch ein externes Schaltgerät geschaltet werden, z.B. einen Timer, es darf nicht an einen Stromkreis angeschlossen werden, der regelmäßig ein und ausschaltet.

## INSTALLATION

Das Gerät darf nur an einem festen Standort verwendet und installiert werden. Die Installation muss von einem qualifizierten Elektriker durchgeführt werden, um jede Gefahr zu vermeiden.

- **WICHTIG!** Stellen Sie sicher, dass sich in der Nähe der Stellen, an denen die Löcher gebohrt werden sollen, keine elektrischen Leitungen oder andere Installationen (z.B. Wasserleitungen) befinden. Achten Sie darauf, das Gerät senkrecht und fest an der Wand zu befestigen.

- Dieses Gerät ist nur für die Installation und Verwendung in Innenräumen vorgesehen.

- Das Gerät sollte nicht direkt unter einer Steckdose aufgestellt werden.

- Halten Sie die Mindestabstände zwischen dem Gerät und den Wänden, dem Boden, den Möbeln, den Vorhängen usw. ein.

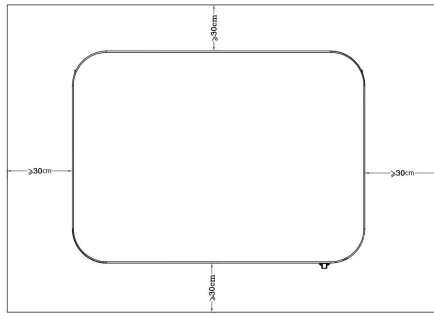

1. Achten Sie darauf, dass der Abstand zwischen dem Heizgerät und dem Boden, der Wand usw. mindestens 30 cm beträgt.

2. Nicht im Badezimmer verwenden und nicht abdecken.

3. Befolgen Sie die Bohrerabmessungen, um die oberen beiden Löcher ( $\varnothing 8$ ) in die Wand zu bohren und setzen Sie die Dehnschrauben in die Löcher.

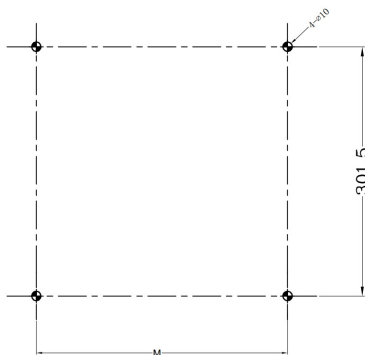

Modell	Ceramic AC 1000	Ceramic AC 1500	Ceramic AC 1800
M (mm)	228	378	378

## DE

4. Die Hakenleisten sind auf der Rückseite des Heizgeräts vormontiert, hängen Sie die oberen beiden Hakenleisten an die Schrauben. Markieren Sie die Position der beiden unteren Hakenleisten an der Wand und nehmen Sie das Heizgerät ab, bohren Sie dann die unteren beiden Löcher ( $\Phi 8$ ) in die Wand und setzen Sie die Kunststoffabdeckung der Dehnschrauben in die Löcher. Die Hakenleisten sind auf der Rückseite des Heizgeräts vormontiert.

5. Hängen Sie das Heizgerät an die Wand und stecken Sie die Dehnschrauben in die unteren beiden Löcher.

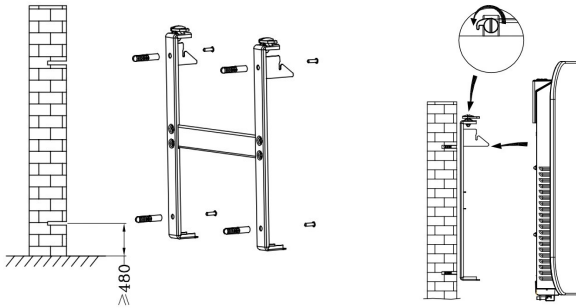

**WARNUNG!** Vergewissern Sie sich vor der Inbetriebnahme des Geräts, dass es ordnungsgemäß an der Wand befestigt ist. Wenn das Gerät nicht waagrecht ausgerichtet ist, können Probleme auftreten.

## ARBEITSWEISE

### BEDIENFELD

- Taste ON / OFF
- Einstellzeit, Tag und Temperatur
- Auswahl von Modus und Programmen
- Erhöhung
- Verringern

### LCD-BILDSCHIRM

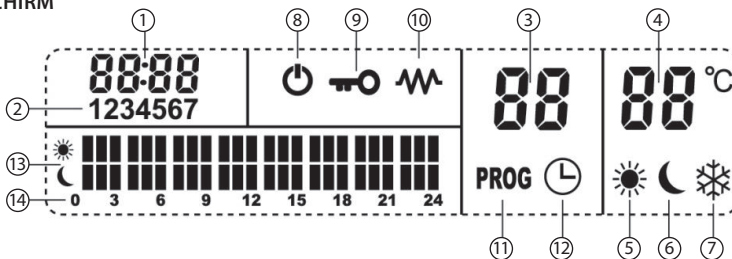

- 1 - Stunde
- 2 - Tag
- 3 - Programm-Nummer
- 4 - Temperierprogramm
- 5 - Komfortmodus
- 6 - Sparmodus
- 7 - Anti-Frost-Modus

- 8 - Nachtmodus ON/OFF
- 9 - Verriegelung
- 10 - Heizung ein
- 11 - Programmauswahl
- 12 - Zeitschaltuhr
- 13 - Programminhalt
- 14 - Zeitskala



Der Heizkörper hat drei verschiedene Betriebsmodi.

1. Eine freie Betriebsart **F<sub>r</sub>** mit laufender Zeitschaltuhr.
2. Ein täglicher Programmmodus mit 9 verschiedenen Programmen von **P 1** bis **P 9**, die zwei Betriebsmodi kombinieren: Komfort ☀, Wirtschaftlichkeit 🌙 und Frost ❄.
3. Ein Wochenprogramm-Modus **RU**: Zuweisung eines Tagesprogramms für jeden Wochentag.

### FREIER BETRIEBSMODUS

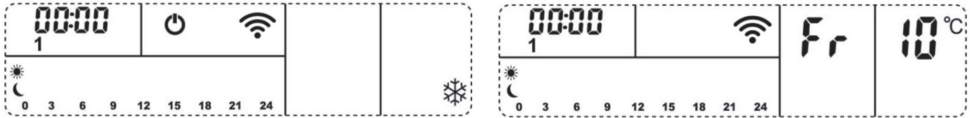

Drücken Sie **(⏻)**, das Symbol **(⏻)** verschwindet. Das Gerät läuft nun frei **F<sub>r</sub>**. Voreingestellte Temperatur von 10°C.

Hinweis: Bei einem Stromausfall wird die Zeit auf 00:00 zurückgesetzt und die Heizung startet wieder mit der zuletzt vor dem Schneiden verwendeten Funktion.

### Einstellung von Tag & Zeit

- Drücken Sie einmal auf **(C/M)**, die Stunden blinken, verwenden Sie dann die Tasten **(▲)** und **(▼)**, um die Stunden einzustellen.
- Drücken Sie erneut auf **(C/M)**, die Minuten blinken, verwenden Sie dann die Tasten **(▲)** und **(▼)**, um die Minuten einzustellen.
- Drücken Sie erneut auf **(C/M)**, das Datum blinkt, verwenden Sie dann die Tasten **(▲)** und **(▼)**, um den Tag zu wählen: 1 - Montag, 2 - Dienstag, 3 - Mittwoch, 4 - Donnerstag, 5 - Freitag, 6 - Samstag, 7 - Sonntag.
- Drücken Sie noch einmal **(C/M)**, um Ihre Wahl zu bestätigen.

### Einstellung der Temperatur

- Drücken Sie einmal **(▲)** oder **(▼)**. Die Temperaturanzeige blinkt.
- Drücken Sie erneut **(▲)** oder **(▼)**, um die gewünschte Temperatur einzustellen. (die Temperatur kann in einem Bereich von 10°C bis 35°C eingestellt werden).
- Nach 5 Sekunden ohne Betätigung der Tasten **(▲)** oder **(▼)** wird die Temperatur validiert.

### Zeitschaltuhr

Drücken Sie 3 Sekunden lang **(C/M)**, das Symbol **(L)** erscheint. Gleichzeitig blinkt die Stundenanzeige und läuft um 00:00 Uhr weiter.

Wählen Sie mit den Tasten **(▲)** und **(▼)** die Betriebszeit in 30-Minuten-Schritten. Nach 5 Sekunden ohne Betätigung der Tasten **(▲)** oder **(▼)** wird die Dauer validiert.



Nach Ablauf der Timerdauer geht der Heizkörper automatisch in den Standby-Modus **(⏻)**.

Hinweis: Um den Timer-Modus zu verlassen, drücken Sie **(C/M)** 3 Sekunden und der Heizkörper kehrt in den freien Betriebsmodus zurück **F<sub>r</sub>**.

### VERWENDUNG VERSCHIEDENER PROGRAMME

#### Auswahl der Betriebsweise:

- RU** Wöchentliches Programm
- P 1\_P 9** Tägliches Programm, das sich täglich wiederholt
- F<sub>r</sub>** Freie Betriebsweise

Erhöhen oder senken Sie die Temperatur durch Verwendung von  oder .

1- Einmal  drücken.

2- Wählen Sie **RU**, **Fr**, **P1**, **P9** mit  oder .



3- Drücken Sie  einmal, um Ihre Wahl zu bestätigen.

HINWEIS : Wenn nach der Auswahl des Programms 5 Sekunden lang keine Taste auf der Tastatur betätigt wird, wird die Auswahl automatisch bestätigt.



### Tägliches Programm

Der Heizkörper hat 9 tägliche Programme von **P1** bis **P9**.

Jedes Segment, das eine Tageszeit darstellt, kann der Betriebsart zugeordnet werden:

-  für Komfort-Modus
-  für Sparmodus
-  für Anti-Frost-Modus

Die 9 Programme sind werksseitig wie folgt voreingestellt:

-  für Komfort-Modus, Temperatur von 22°C.
-  für Sparmodus, Temperatur von 17°C.
-  für Anti-Frost-Modus, Temperatur von 7°C (dieser Modus kann nicht personalisiert werden !).

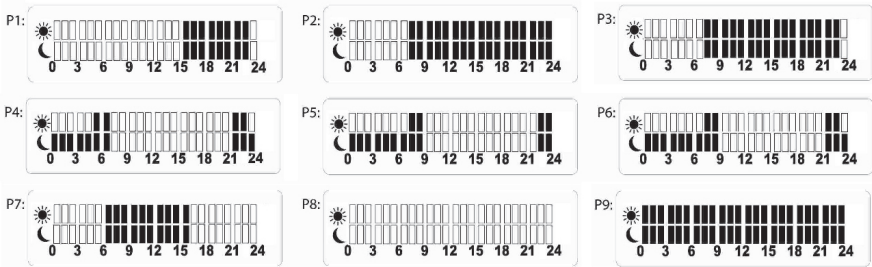

### Personalisierung der Betriebsart Komfort und Sparmodus

1- Unter P1 bis P9 Tagesprogramm  3 Sekunden lang drücken, die Temperaturanzeige blinkt.

2- Verwenden Sie  oder , um die gewünschte Temperatur für den Komfortmodus einzustellen.

3- Drücken Sie , um Ihre Auswahl zu bestätigen, die Temperaturanzeige blinkt.

4- Verwenden Sie  oder , um die gewünschte Temperatur für den Sparmodus einzustellen.

5- Drücken Sie , um Ihre Auswahl zu bestätigen, die Temperaturanzeige blinkt.

6- Der Heizkörper kehrt automatisch in den Komfortmodus zurück .

HINWEIS :



Wenn die Komfort- und ECO-Temperatur eines Tagesprogramms (P1 bis P9) geändert wird, werden alle Tagesprogramme und die Komfort- und ECO-Temperatur des Automatikbetriebs ebenfalls geändert.

HINWEIS :

1. Wenn nach der Auswahl des Programms 5 Sekunden lang keine Taste auf der Tastatur betätigt wird, wird die Auswahl automatisch bestätigt.

2. Wenn ein Tagesprogramm (P1 bis P9) Komfort und ECO-Temperatur geändert wird, werden alle Tagesprogramme und die Komfort- und ECO-Temperatur des Automatikbetriebs geändert.

### Personalisierung der Tagesprogramme:

Drücken Sie , wählen Sie dann das Programm, das Sie von **P 1** bis **P 9** personalisieren möchten, mit  oder .





1-  3 Sekunden lang drücken, auf dem Display erscheint das Symbol PROG.

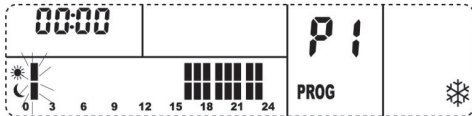

2- Das erste Segment  von 00 : 00 blinkt.

Beispiel Programm P1 :



Benutzen Sie , um zu wählen, wie diese erste Stunde zugeordnet werden soll.

(  für Komfort  für Sparmodul  und  für Frostbetrieb  )

3- Verwenden Sie  oder , um zur nächsten oder vorherigen Stunde des Programms zu gehen. Wiederholen Sie 2, bis jedes Segment des Programms angepasst ist.

4- Drücken Sie  3 Sekunden lang, um Ihr Programm zu bestätigen. Das Symbol PROG verschwindet auf dem Bildschirm.



ANMERKUNG: Das neue Programm ersetzt das alte Programm im Speicher des Geräts.

Wenn Ihre persönlichen Einstellungen Sie nicht zufrieden stellen, können Sie zur Werkseinstellung zurückkehren. Schalten Sie das Gerät mit dem Schalter auf der Rückseite des Gerätes aus. Drücken Sie dann die Taste  7 Sekunden lang, um das Gerät zurückzusetzen.

Die Anpassung der Tagesprogramme muss vor der wöchentlichen Programmierung vorgenommen werden.

### Wöchentliche Programmierung:

1- Einmal  drücken.

2- Wählen Sie das Tagesprogramm **AU** mit  oder  aus.

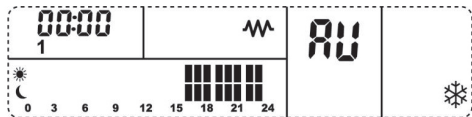

3- Drücken Sie  einmal, um Ihre Wahl zu bestätigen.

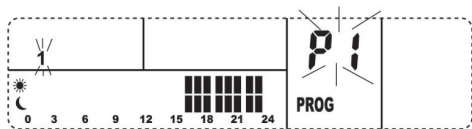

4-  3 Sekunden lang drücken, das Symbol PROG erscheint auf dem Display.

5- Die Zahl 1, die für MONTAG steht, und das entsprechende Programm P1 blinken.



6- Weisen Sie mit  oder  ein Programm (von P1 bis P9) für Montag zu. Bestätigen Sie Ihre Auswahl mit . Die Zahl 2 blinkt - sie steht für Dienstag. Wiederholen Sie den Vorgang, bis Sie für jeden Wochentag (1 - bis 7 Montag-Sonntag) ein Programm zugewiesen haben.

7- Nachdem Sie das Programm dem 7-Sonntag zugeordnet haben, bestätigen Sie Ihre Auswahl mit . Die

Ikone PROG verschwindet auf dem Display.

8- Das Heizgerät arbeitet dann gemäß dem neuen Wochenprogramm, das Sie soeben erstellt haben .

### FENSTER ÖFFNEN FUNKTION

Ihr Heizgerät hat die Funktion eines offenen Fensters. Wenn Sie ein Fenster in dem Raum, in dem sich das Heizgerät befindet, weit öffnen und die Temperatur innerhalb von 5 Minuten um mehr als 2 °C absinkt, erkennt ein Sensor den starken Temperaturabfall. Das Heizgerät schaltet sich automatisch aus und das Symbol **FO** flackert auf Ihrem Bildschirm. Das Heizgerät kehrt in den vorherigen Modus zurück, wenn die Raumtemperatur innerhalb von 5 Minuten um mehr als 2 °C ansteigt. Sie können das Heizgerät jedoch durch Drücken der Taste

 manuell neu starten. Das Symbol **FO** verschwindet auf dem Bildschirm.

Im Bereitschaftsmodus halten Sie die Taste  5 Sekunden lang gedrückt, das Symbol **FO** wird auf dem Bildschirm angezeigt und das Symbol **OF** flackert auf dem Bildschirm. **OF** zeigt "Funktion nicht in Betrieb" an.



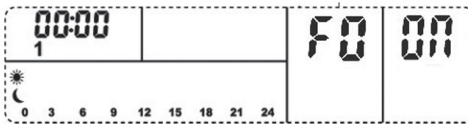

Drücken Sie die Taste  oder , um das Symbol von **OF** in **ON** zu ändern, **ON** zeigt "Funktion in Betrieb" an.



### VERRIEGELUNG

Das Gerät sperrt sich automatisch, wenn es 30 Sekunden lang unbehellig bleibt.



Um den Heizkörper jederzeit zu entriegeln (ein Schlüsselsymbol wird im mittleren linken Bereich des Displays angezeigt), drücken Sie gleichzeitig  und .

### TEMPERATUR-KALIBRIERUNG

Halten Sie im Bereitschaftsmodus die Taste  10 Sekunden lang gedrückt.

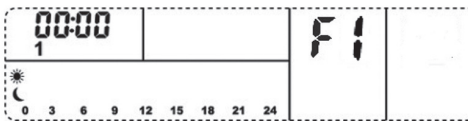
Zuerst erscheint auf dem Bildschirm F1. Bitte beachten Sie, dass dies für die Einstellung der internen Sensortemperatur des Heizgeräts verwendet wird, bitte stellen Sie diese niemals ein.



Zweitens, nachdem F1 erscheint, drücken Sie die Taste , um zu F2 zu wechseln, und drücken Sie dann die Taste  oder , um die "Temperaturkalibrierung" von -5°C auf 5°C zu ändern.

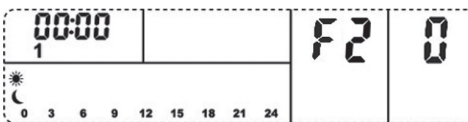

## SICHERHEITSVORRICHTUNG GEGEN ÜBERHITZUNG

Der Heizkörper ist mit einer Sicherheitsvorrichtung ausgestattet, die bei Überhitzung die Heizung abschaltet. Falls der Heizkörper nicht mehr funktioniert, schalten Sie den Heizkörper aus und führen Sie eine Inspektion an den Eingängen und Entlüftungsöffnungen durch, um festzustellen, ob diese verstopft sind. Warten Sie mindestens 5 Minuten, damit das Schutzsystem zurückgesetzt wird, bevor Sie das Heizgerät wieder in Betrieb nehmen. Wenn das Heizgerät nicht funktioniert oder die Schutzvorrichtung wieder ausgeschaltet wird, bringen Sie das Gerät zur Überlegung oder zur Reparatur in die nächstgelegene Kundendienststelle.

## REINIGUNG UND AUFRECHTERHALTUNG

- Das Gerät immer ausschalten und das Stromkabel vor der Reinigung entfernen.
- Den Heizkörper immer völlig abkühlen lassen.
- Im keinen Fall den Heizkörper ins Wasser oder in andere Flüssigkeiten eintauchen.
- Reinigen Sie das Gerät mindestens einmal im Jahr mit einem Staubsauger, um Staubablagerungen zu entfernen.
- Reinigen Sie Ihre Heizung mit einem weichen, feuchten Tuch.
- Kein chemisches Reinigungsmittel benutzen, um den Radiator zu reinigen.
- Gerät regelmäßig reinigen.

## GARANTIE

Die Gewährleistung endet nach 36 Monate bei Beginn von Rechnungsdatum. Die Gewährleistung beinhaltet jegliches defekt der Rohstoffe oder Herstellungsfehler bei der Produktion des Gerätes unter Voraussetzung der Benutzung des Gerätes nach den Gebrauchs- und Bedienungsanweisungen sowie Pflegeangaben des Hersteller/Händler und der Installation nach den hiesigen Anleitungen. In keinem Falle werden Defekte Aufgrund von Unfall, Nachlässigkeit oder Ungeschicklichkeit beim Gebrauch des Gerätes gewährleistet. Die Gewährleistung erstreckt sich auf die Reparatur in unseren Werkstätten bzw. zugelassenen Werkstätten sowie das Ersetzen der defekten Teilen und deren Einbaukosten. Jegliche Personen- oder Sachschadenentschädigungen Aufgrund von Unfällen, schlechter Bedienung oder Funktionsstörungen sind ausgeschlossen. Die Gewährleistung unterbricht sich wenn das Gerät durch nicht autorisiertes Personal sowie der Einbau nicht originaler Teile durchgeführt wird. Damit die Gewährleistung erkannt werden kann, muss die Rechnung des Kaufes vorgelegt werden.

## ENTSORGUNG GEBRAUCHTEN HAUSHALTSGERÄTEN



Die EU-Richtlinie 2012/19/EC (WEEE) in Sachen Elektronischer Abfallgeräte, fordert das gebrauchte Haushaltsgeräte nicht in der herkömmlichen Abfallentwicklung entsorgt werden. Mit dem Ziel der Optimierung der Wiedergewinnung und des Recycling der eingesetzten Materialien sowie die Reduzierung der negativen Wirkungen auf die Menschliche Gesundheit und Umwelt müssen gebrauchte Geräte separat gehandhabt werden.

## ERFORDERLICHE ANGABEN ZU ELEKTRISCHEN EINZELRAUMHEIZGERÄTEN

Modellkennung(en):		CERAMIC A			
Angabe	Symbol	Wert	Einheit	Angabe	Einheit
Wärmeleistung <b>CERAMIC AC 1000</b>				Nur bei elektrischen Speicher-Einzelraumheizgeräten: Art der Regelung der Wärmezufuhr (bitte eine Möglichkeit auswählen)	<b>N/A</b>
Nennwärmeleistung	P <sub>nom</sub>	1.0	kW	manuelle Regelung der Wärmezufuhr mit integriertem Thermostat	[nein]
Mindestwärmeleistung (Richtwert)	P <sub>min</sub>		kW	manuelle Regelung der Wärmezufuhr mit Rückmeldung der Raum- und/oder Außentemperatur	[nein]
Maximale kontinuierliche Wärmeleistung	P <sub>max,c</sub>		kW	elektronische Regelung der Wärmezufuhr mit Rückmeldung der Raum- und/oder Außentemperatur	[nein]
<b>Hilfsstromverbrauch</b>				Wärmeabgabe mit Gebläseunterstützung	[nein]
Bei Nennwärmeleistung	e <sub>lmax</sub>	N/A	kW	<b>Art der Wärmeleistung/Raumtemperaturkontrolle (bitte eine Möglichkeit auswählen)</b>	
Bei Mindestwärmeleistung	e <sub>lmin</sub>	N/A	kW	einstufige Wärmeleistung, keine Raumtemperaturkontrolle	[nein]
Im Bereitschaftszustand	e <sub>lSB</sub>	N/A	kW	zwei oder mehr manuell einstellbare Stufen, keine Raumtemperaturkontrolle	[nein]
Wärmeleistung <b>CERAMIC AC 1500</b>				Raumtemperaturkontrolle mit mechanischem Thermostat	[nein]
Nennwärmeleistung	P <sub>nom</sub>	1.5	kW	mit elektronischer Raumtemperaturkontrolle	[nein]
Mindestwärmeleistung (Richtwert)	P <sub>min</sub>		kW	elektronische Raumtemperaturkontrolle und Tageszeitregelung	[nein]
Maximale kontinuierliche Wärmeleistung	P <sub>max,c</sub>		kW	elektronische Raumtemperaturkontrolle und Wochentagsregelung	[ja]
<b>Hilfsstromverbrauch</b>				<b>Sonstige Regelungsoptionen (Mehrfachnennungen möglich)</b>	<b>N/A</b>
Bei Nennwärmeleistung	e <sub>lmax</sub>	N/A	kW	Raumtemperaturkontrolle mit Präsenzerkennung	[nein]
Bei Mindestwärmeleistung	e <sub>lmin</sub>	N/A	kW	Raumtemperaturkontrolle mit Erkennung offener Fenster	[ja]
Im Bereitschaftszustand	e <sub>lSB</sub>	N/A	kW	mit Fernbedienungsoption	[ja]
Wärmeleistung <b>CERAMIC AC 1800</b>				mit adaptiver Regelung des Heizbeginns	[nein]
Nennwärmeleistung	P <sub>nom</sub>	1.8	kW	mit Betriebszeitbegrenzung	[nein]
Mindestwärmeleistung (Richtwert)	P <sub>min</sub>		kW	mit Schwarzkugelsensor	[nein]
Maximale kontinuierliche Wärmeleistung	P <sub>max,c</sub>		kW		
<b>Hilfsstromverbrauch</b>					
Bei Nennwärmeleistung	e <sub>lmax</sub>	N/A	kW		
Bei Mindestwärmeleistung	e <sub>lmin</sub>	N/A	kW		
Im Bereitschaftszustand	e <sub>lSB</sub>	N/A	kW		
Kontaktangaben		<b>CLIMACITY S.L.</b> C. Torrox, 2 - 5 · 28041 Madrid (ESPAÑA) - tel. +34 91 392 05 09			



- El contenido de este manual y las especificaciones de este producto están sujetos a cambios sin previo aviso. La última versión de este manual está disponible en la página web [www.purline.es](http://www.purline.es)
- The contents of this operation manual and the specifications of this product are subject to change without notice. An updated manual is available on [www.purline.es](http://www.purline.es)
- Le contenu de ce manuel et les caractéristiques de ce produit sont sujets à modifications sans préavis. Vous pouvez télécharger la version actuelle du manuel: [www.purline.es](http://www.purline.es)
- O conteúdo deste manual e as especificações deste produto estão sujeitos a alterações sem aviso prévio. Você pode descarregar a versão atual do Manual: [www.purline.es](http://www.purline.es)
- Il contenuto di questo manuale e le specifiche di questo prodotto sono soggetti a modifiche senza preavviso. L'ultima versione del manuale di istruzioni può essere scaricata dal sito [www.purline.es](http://www.purline.es)
- Der Inhalt dieses Handbuchs und die technischen Daten dieses Produktes können ohne vorherige Ankündigung geändert werden. Aktuellste Bedienungsanleitung online abrufbar: [www.purline.es](http://www.purline.es)



**CLIMACITY S.L.**

C. Torrox, 2 - 5 · 28041 Madrid (ESPAÑA)

tel. 91 392 05 09 • [www.purline.es](http://www.purline.es)