

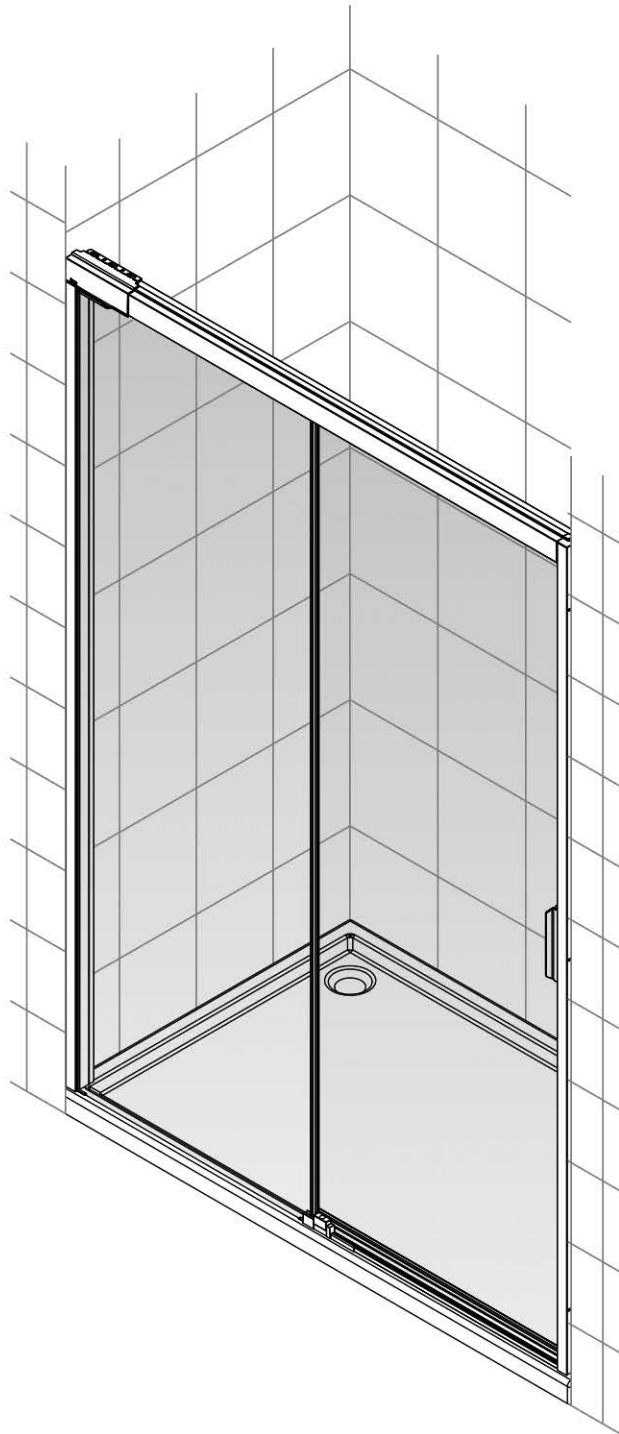

Roca

L2-E



L2-E

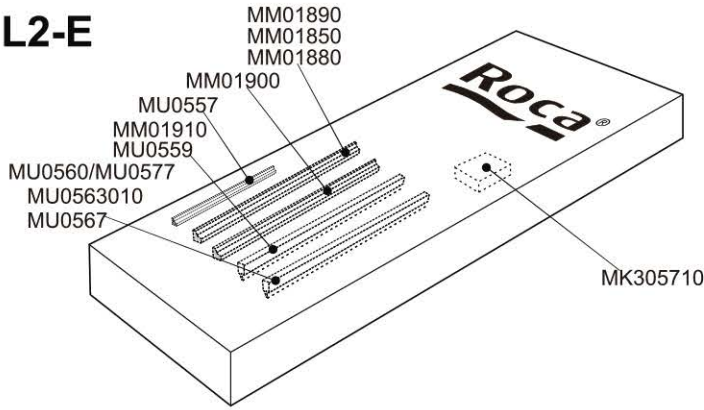

MK305710

MK202410	x1	x1		
MK405580	x1			
MK202470	x2			
MK202550	x1	x1		
MK202420	x1	x1		
MK202430	x1	x1		
MK201940	x3	Ø6 x3		
MK202350	x1 MTS0019	x1 MTS0020	x1 MTS0021	x1 MTS0022

MM01890 x1	MM0185 x1	MM01880 x1	MM01900 x1	MU0557 x1	
MM01910 x1	MU0560 x1 MU0560020		 x1 MU0560010	MU0563010 x1	MU0567 x1

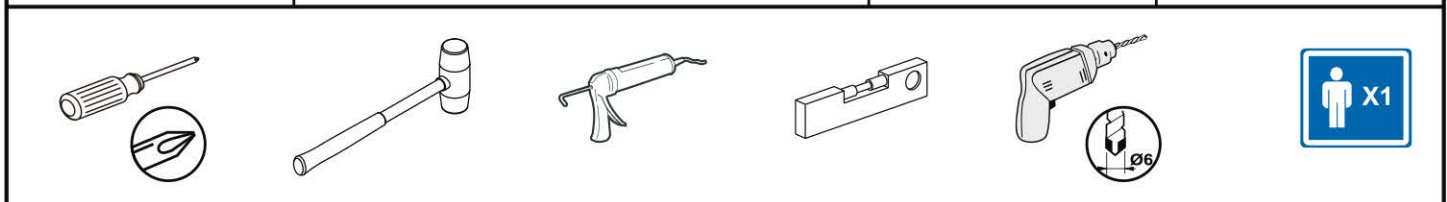

1

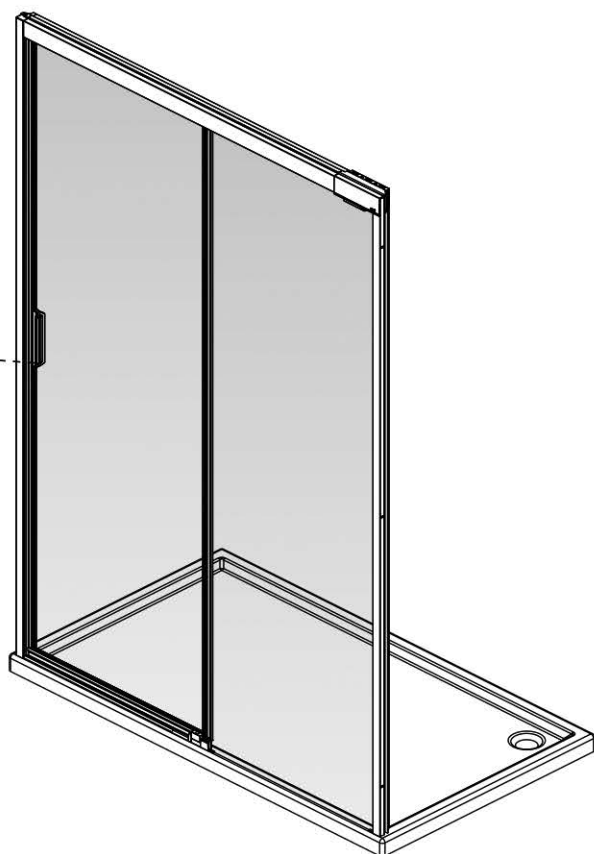
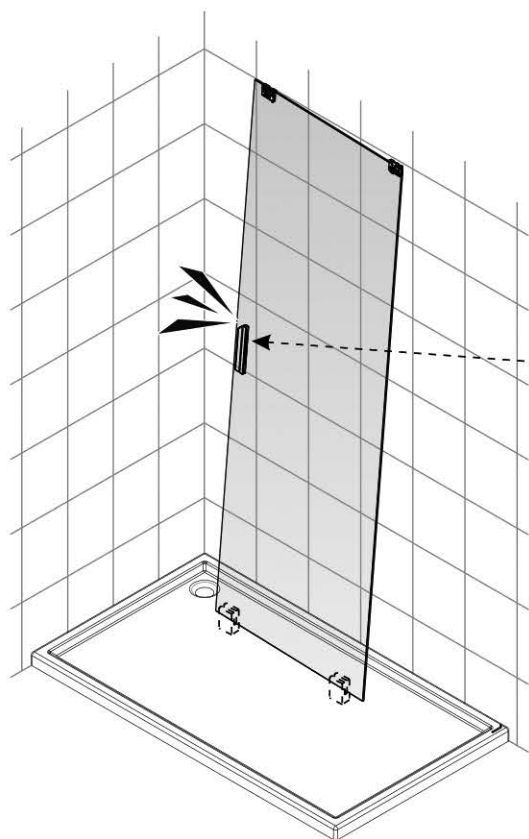
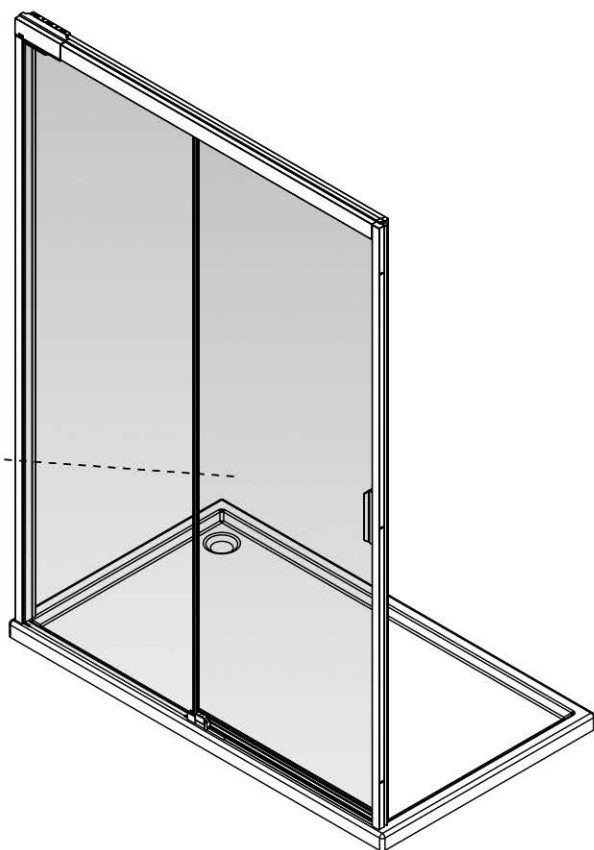
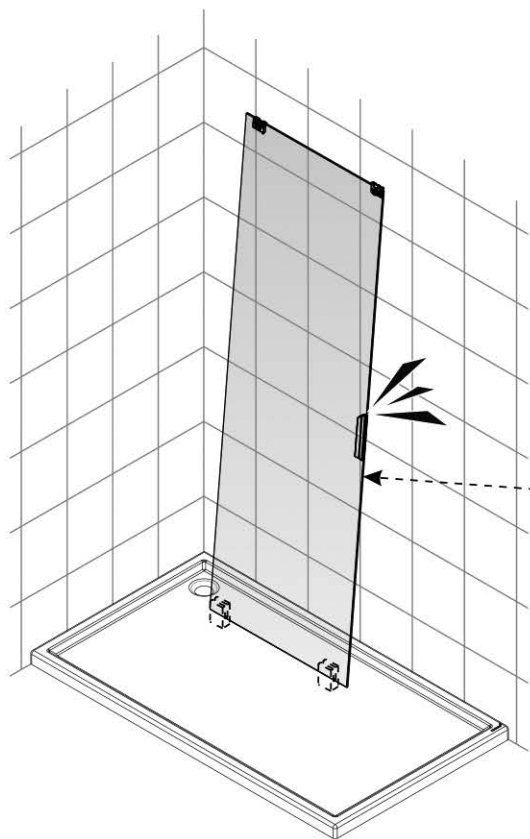

2

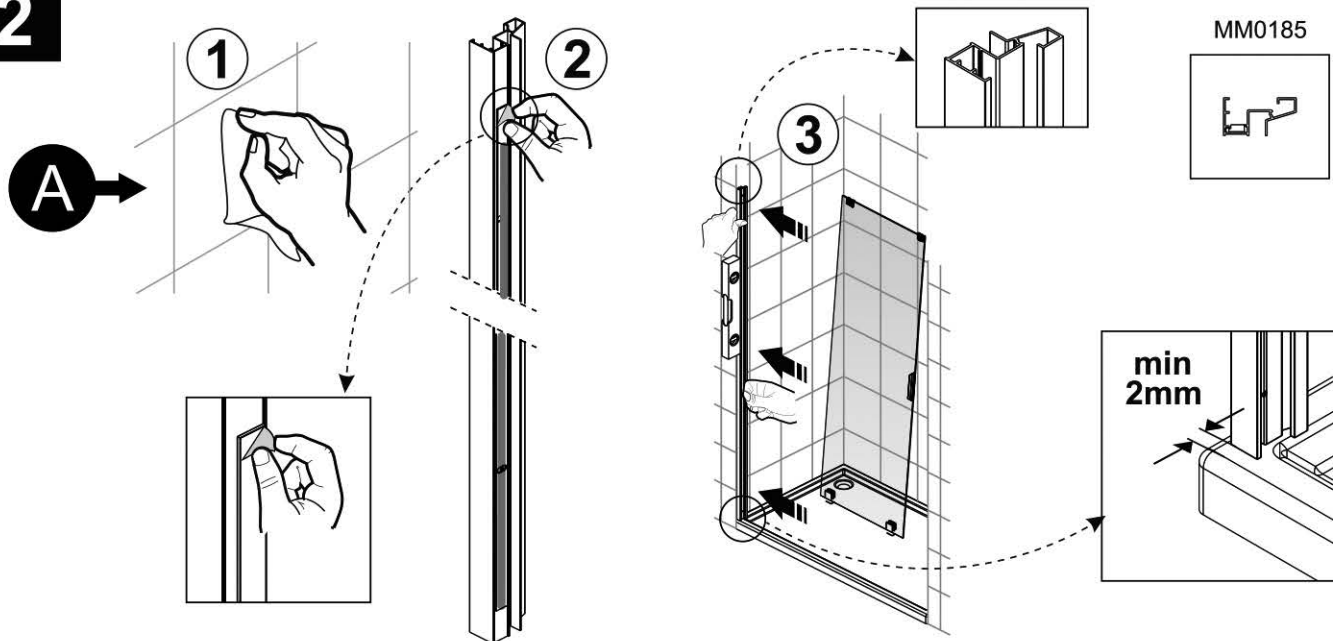

⚠ **A/B** ⚠

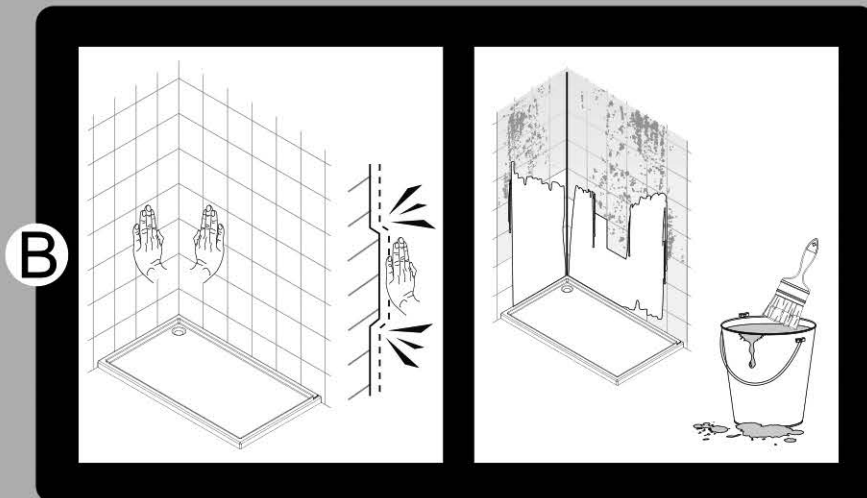
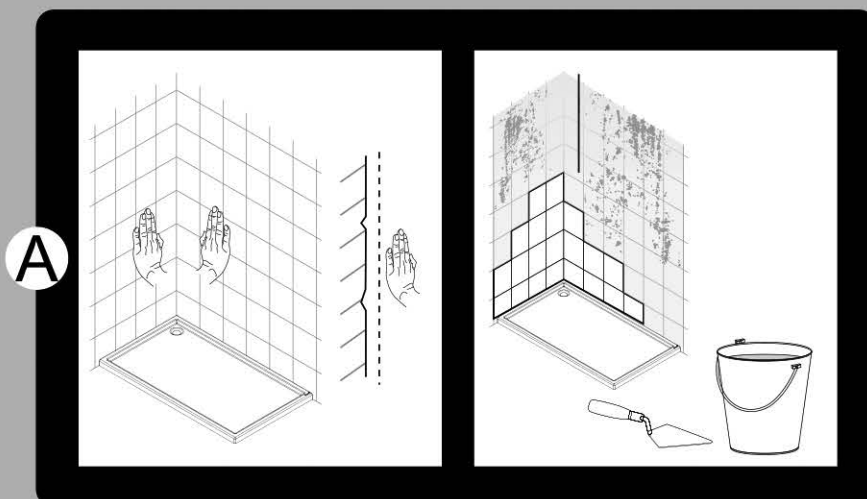

B →

* OPCION/OPTION/OPZIONE/OPÇÃO



MK201940

3

A →

1

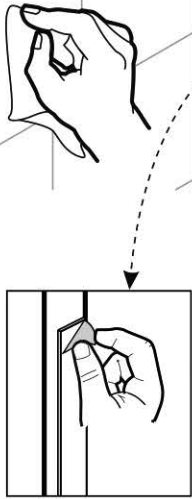

2

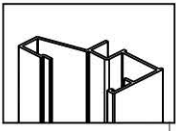

3

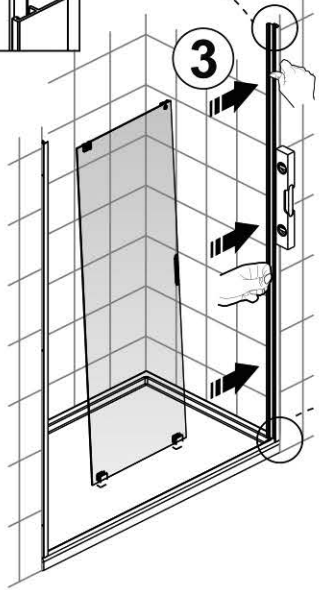

MM0188

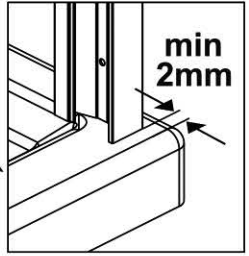
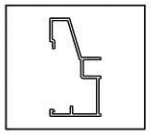

min 2mm



A/B



A

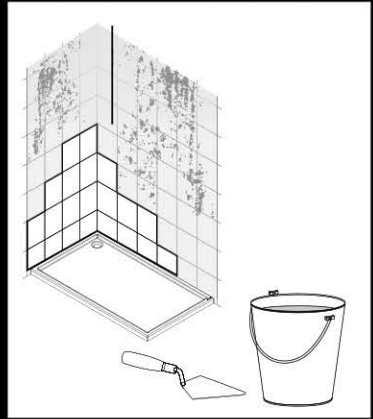
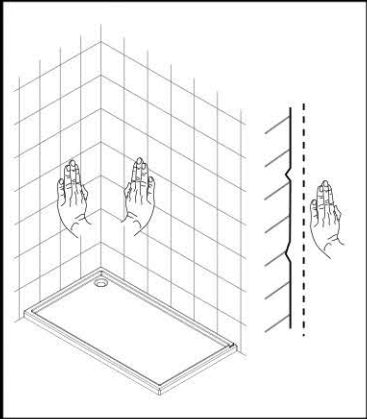

B

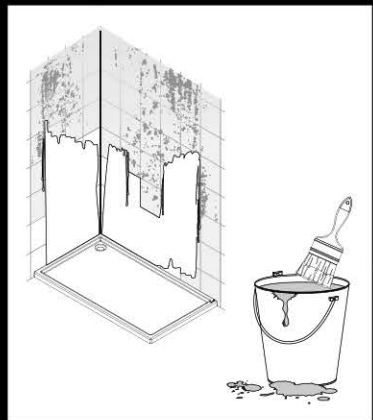
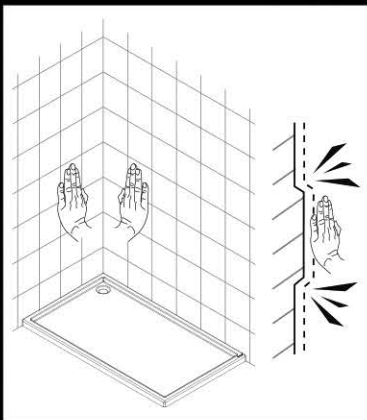

B →

* OPCION/OPTION/OPZIONE/OPÇÃO



MK201940

4

MM01910

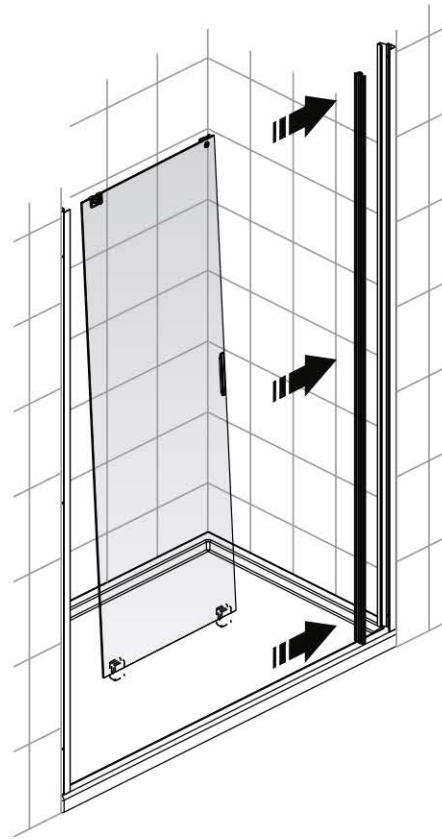
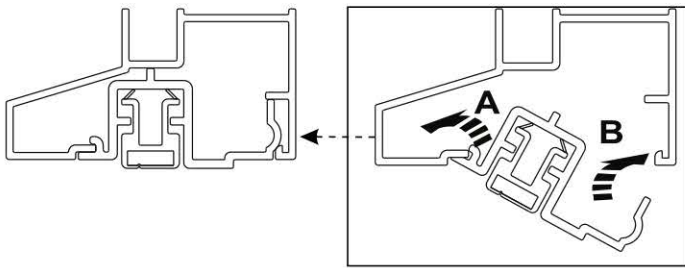
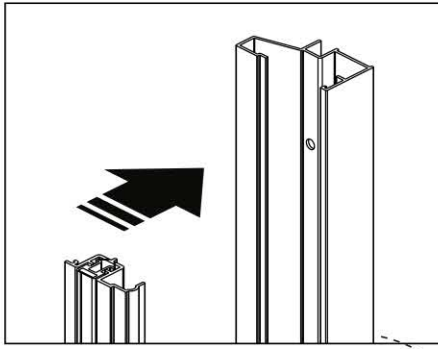
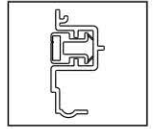

5

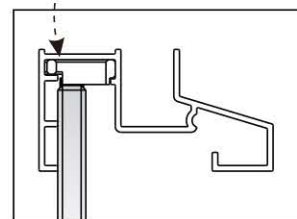
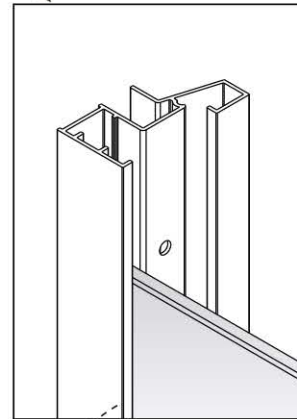
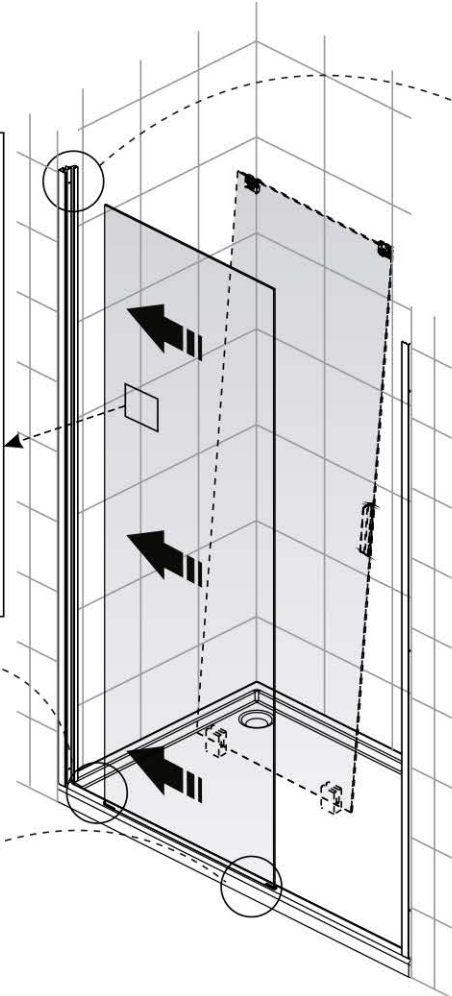
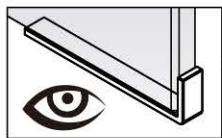
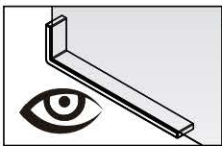
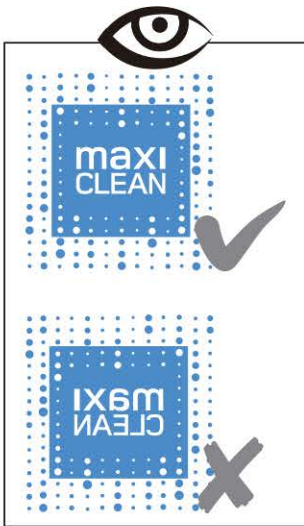

6

MU0557

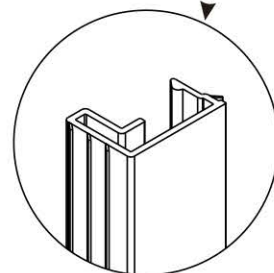
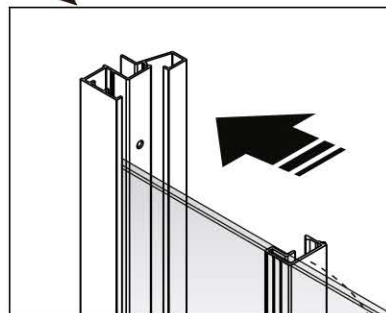
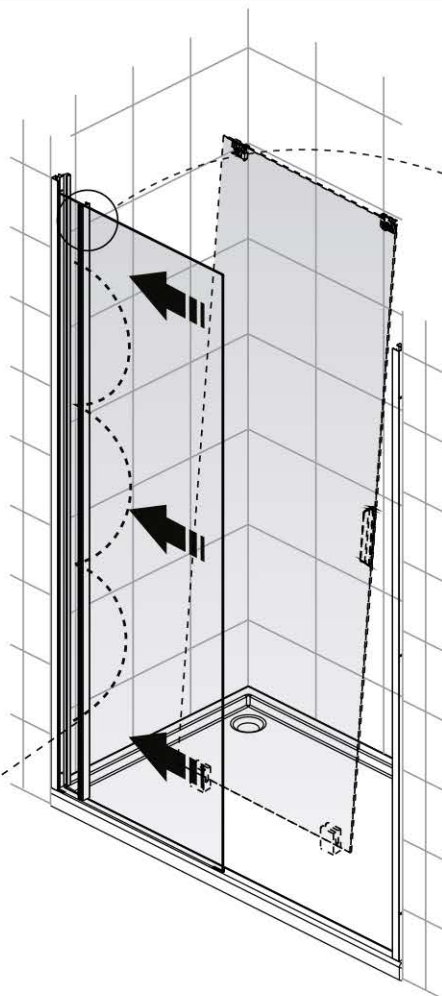
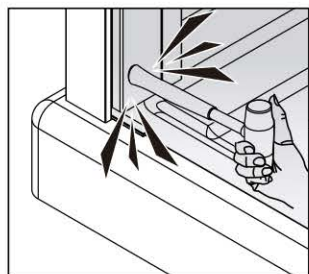

7

MM01900

MK202430

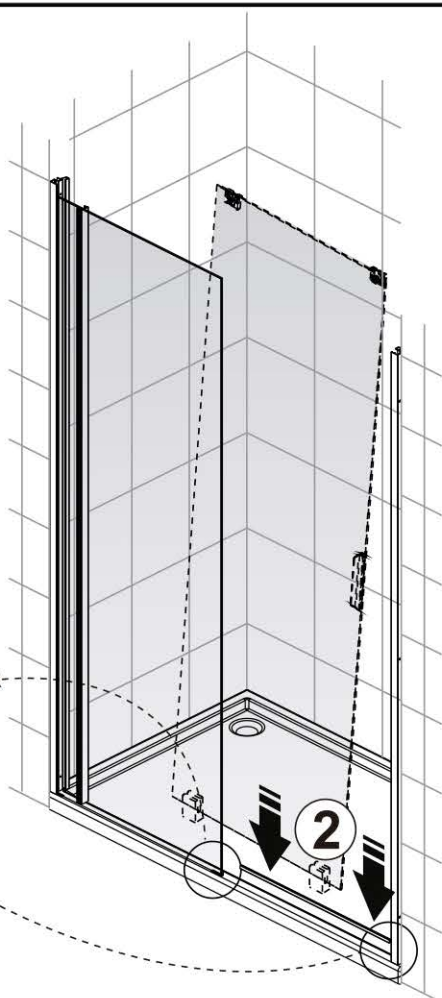
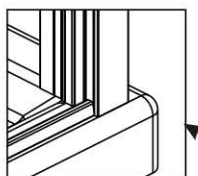
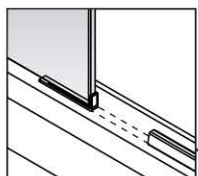
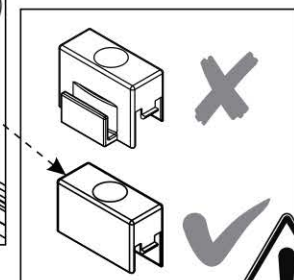
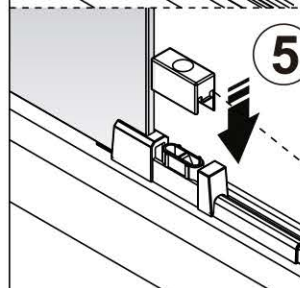
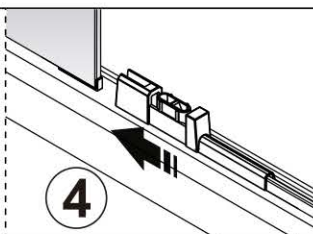
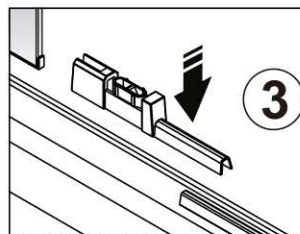
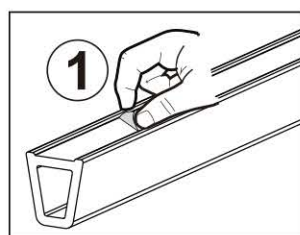
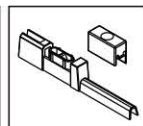
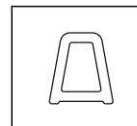

8

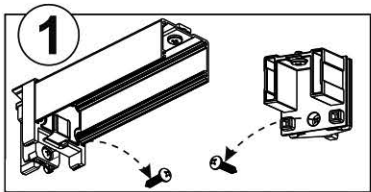

MM01890

MK202550

MK405580

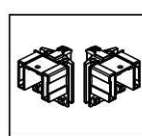
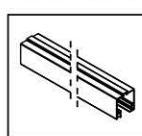

2

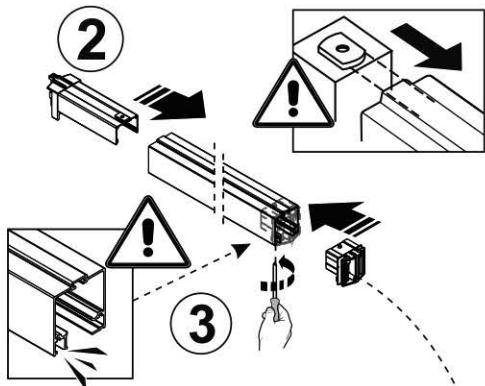

3

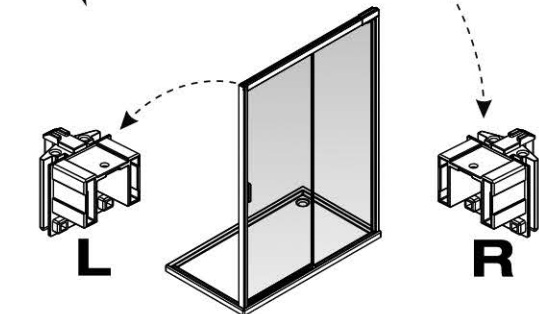

4

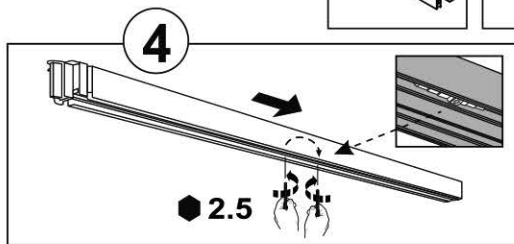

5

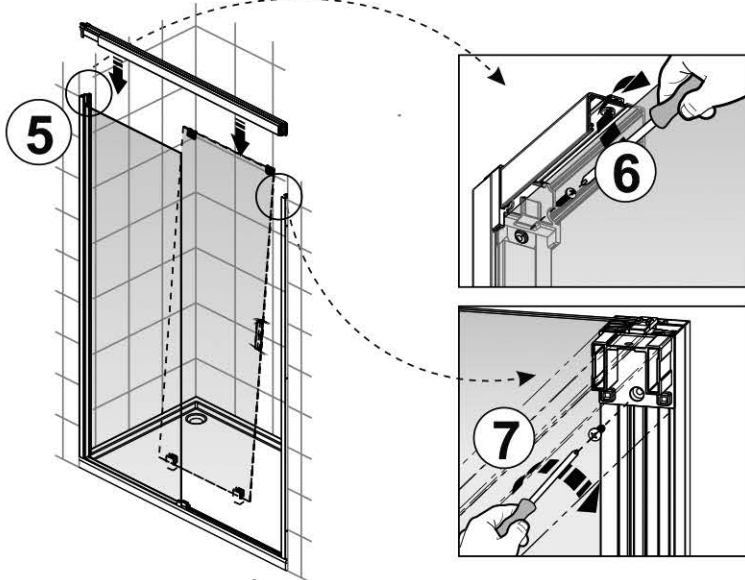

6

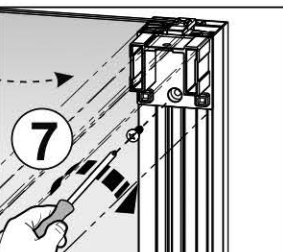
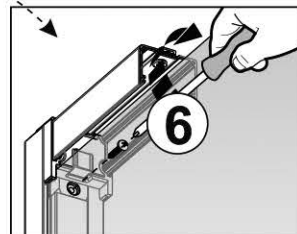

9

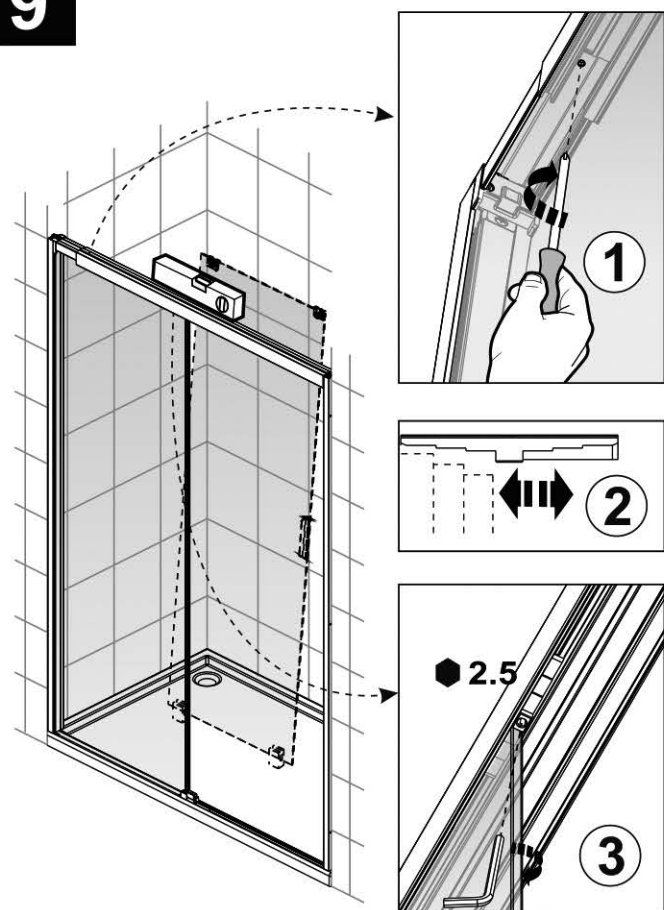

1

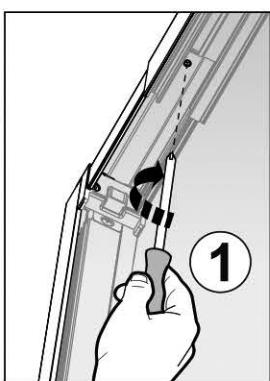

2

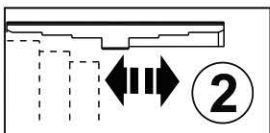

3

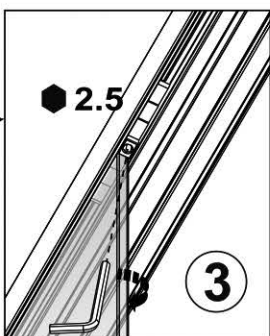

10

MU0560020

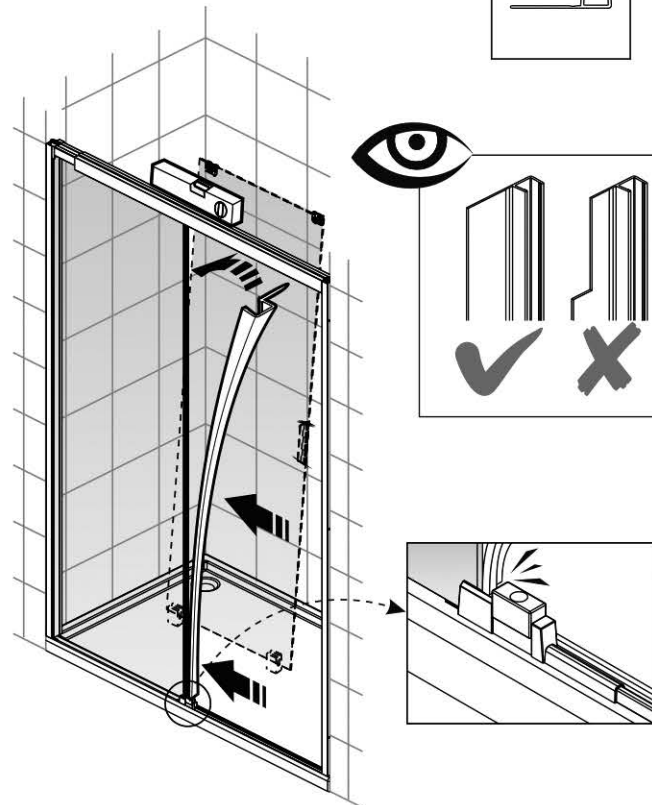
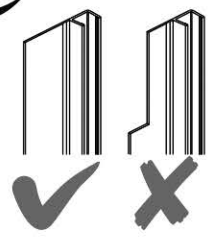
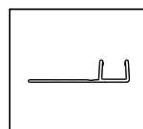

11

MK202470

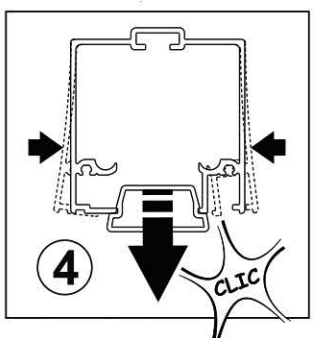
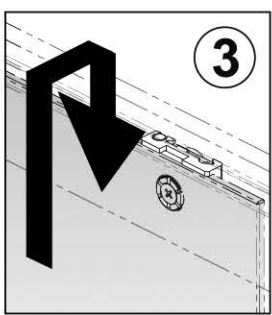
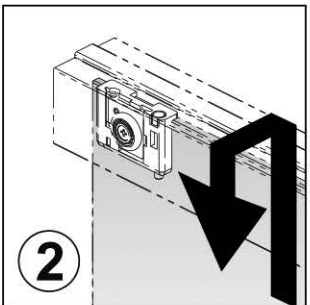
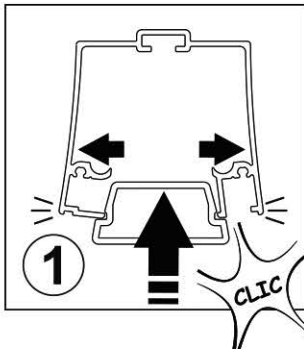
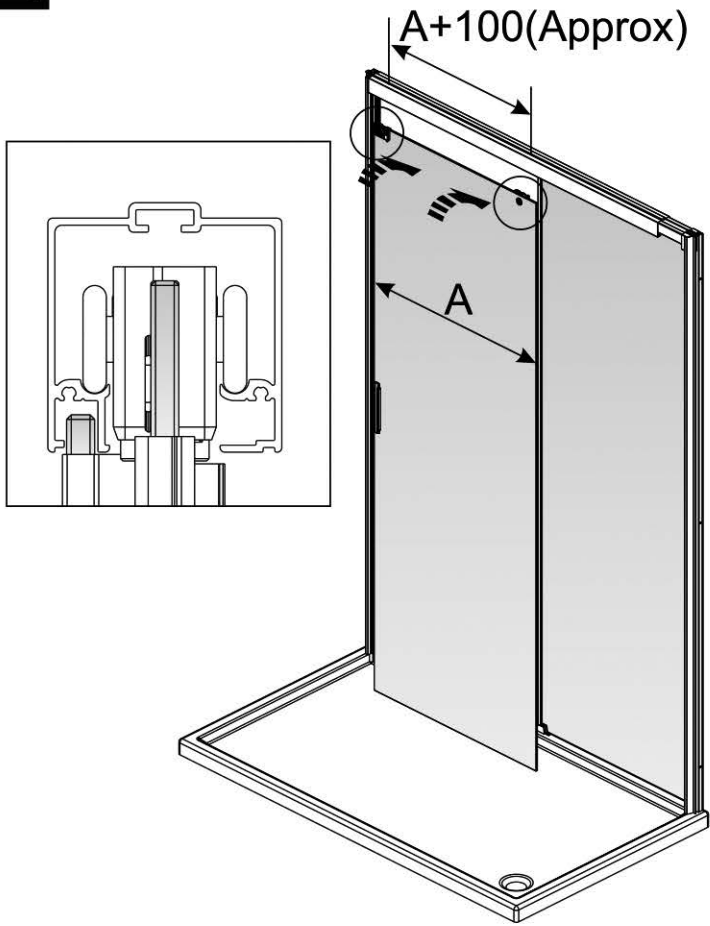
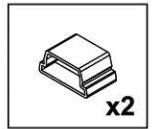

12

MU0560010

MU0563010

MU0567

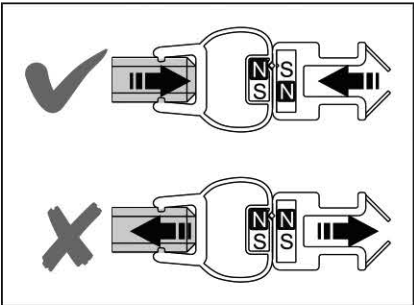
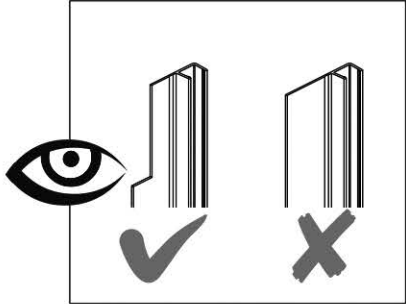
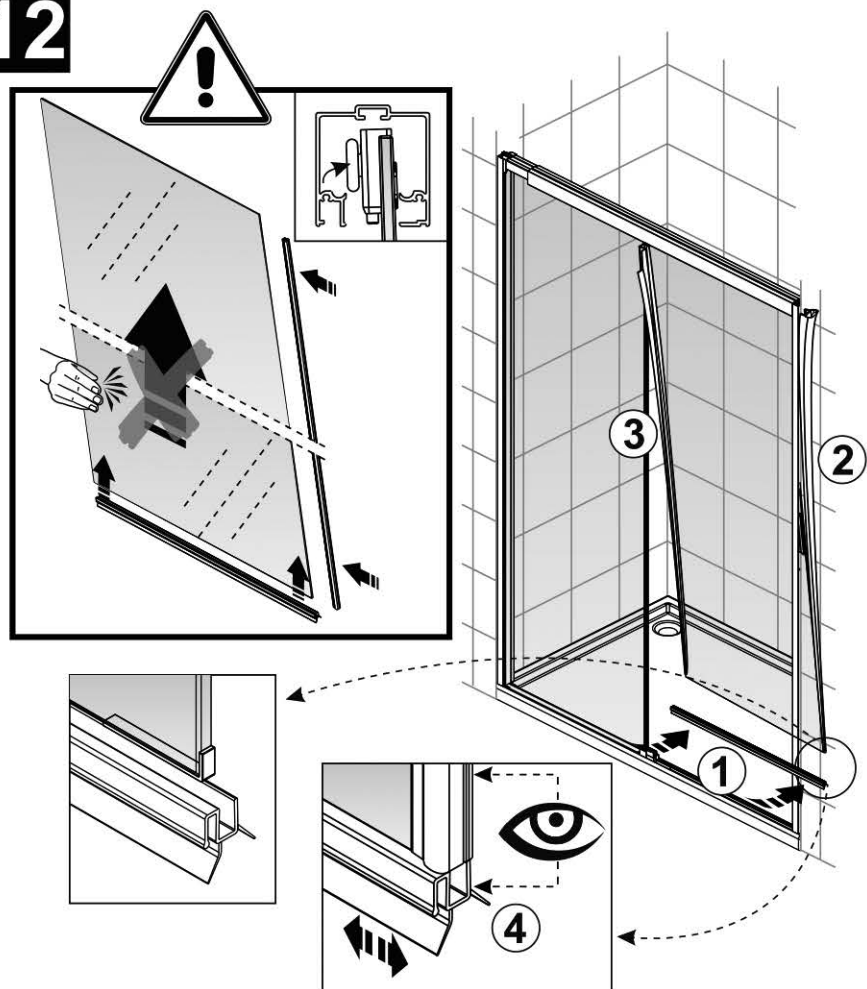
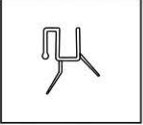
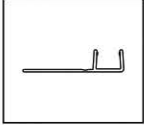

13

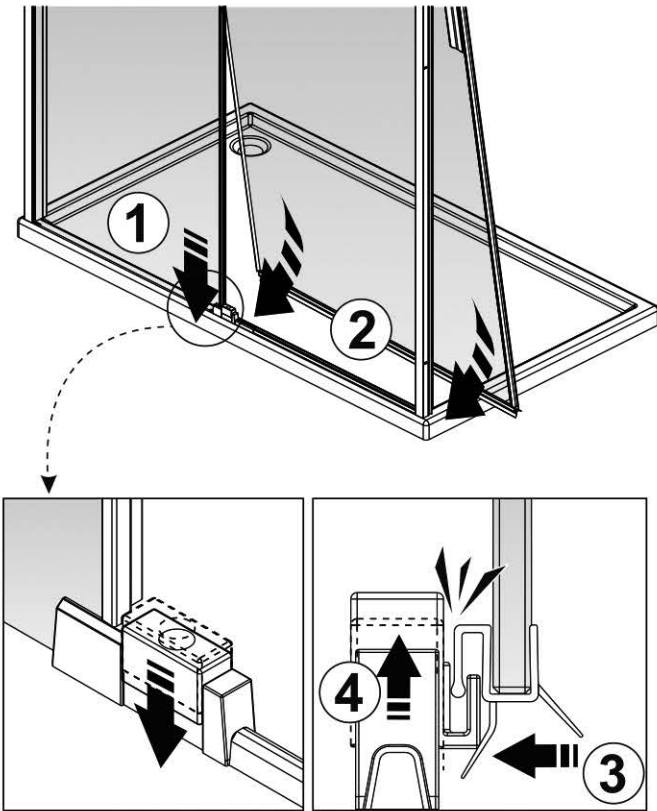

14

MK20235

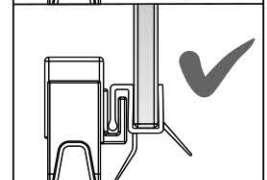
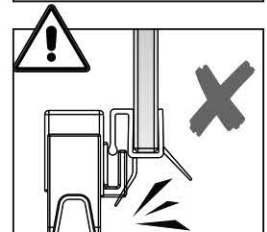
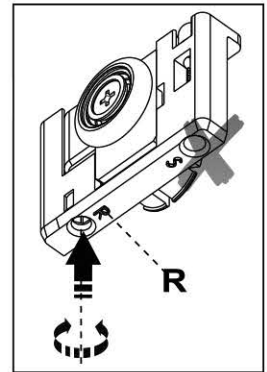
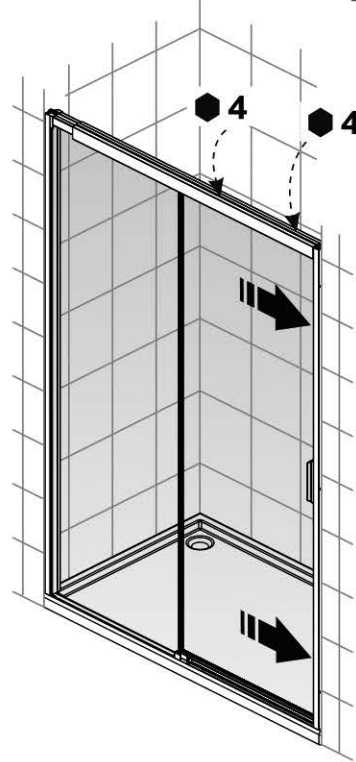
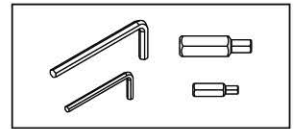

15

MK20235

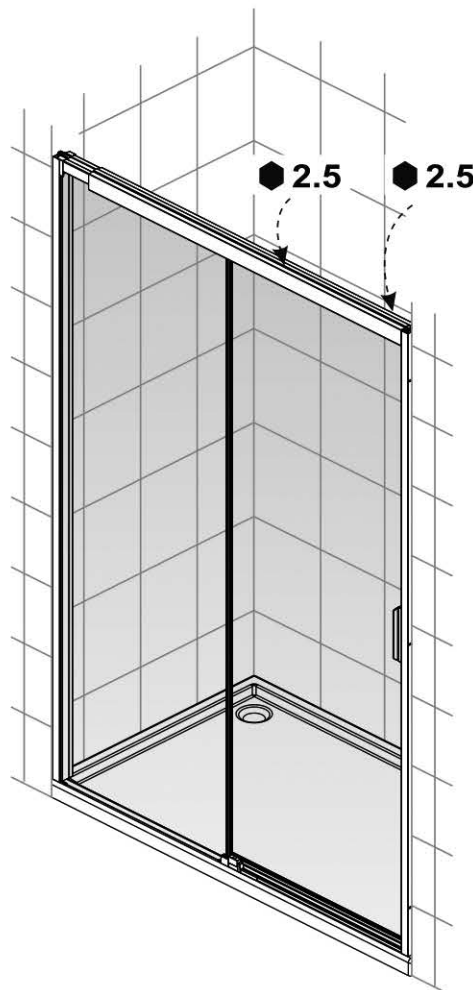
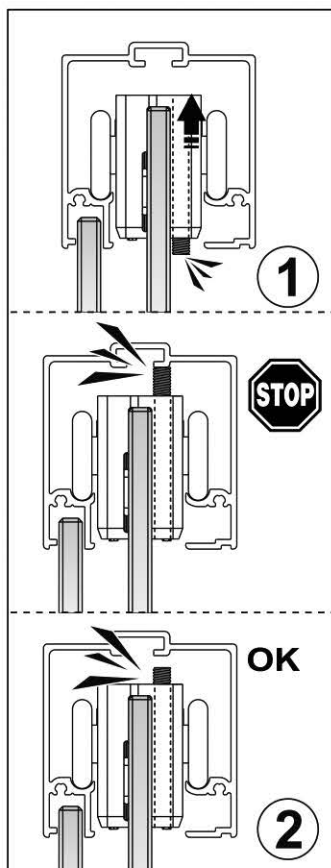
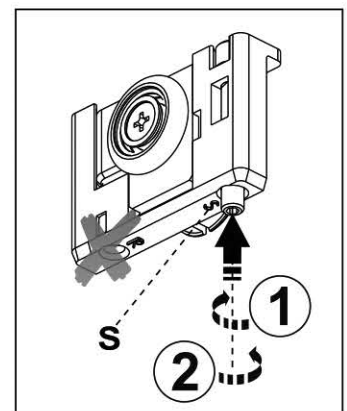
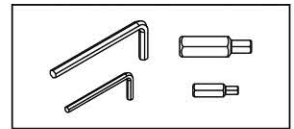

16

MK202410

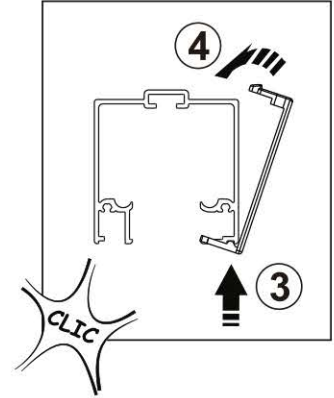
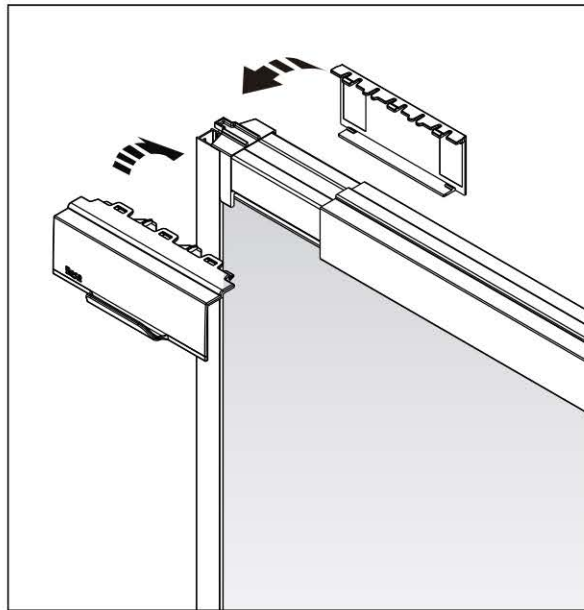
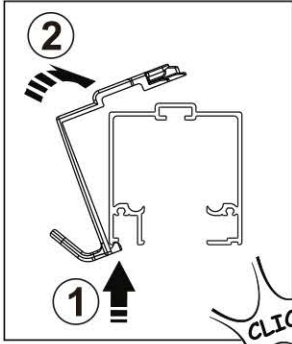
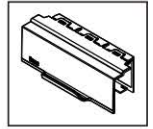

17

MK202420



MTP0425

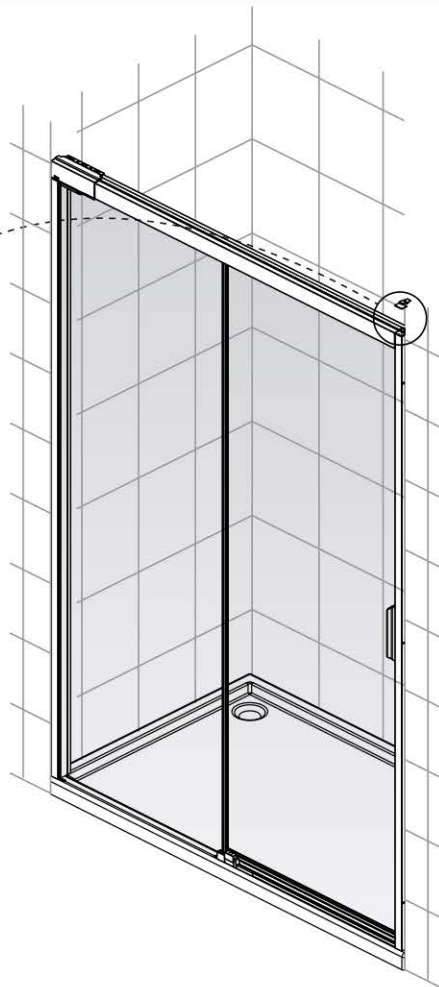
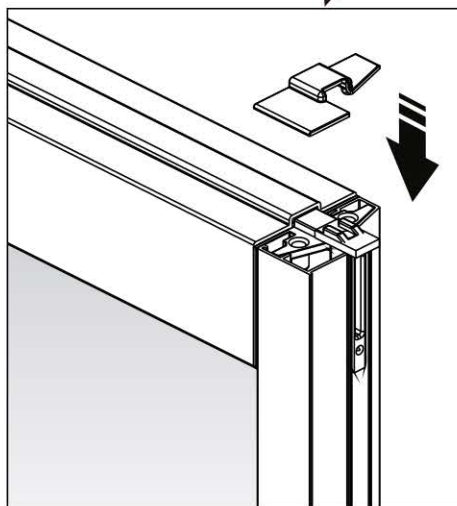

18

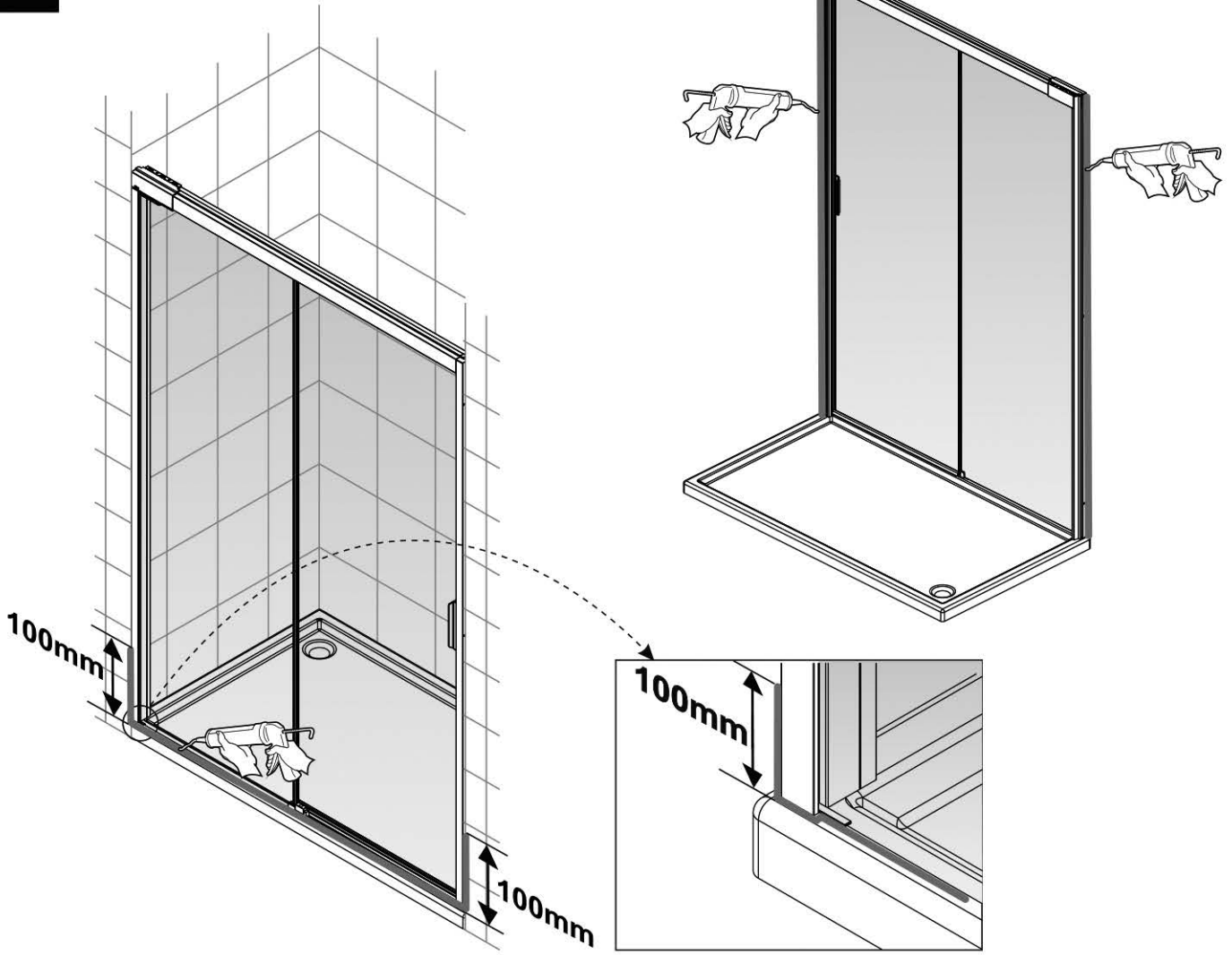

 10 H

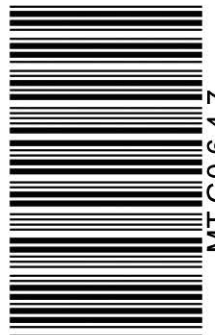
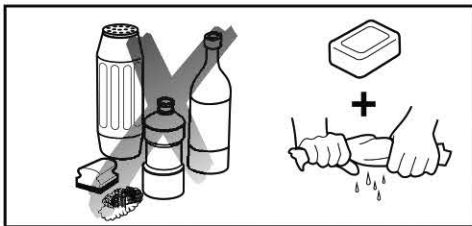

V5

MT G0 6 4 7

Roca Sanitario, S.A.

Avda. Diagonal, 513
 08029 Barcelona - SPAIN
 Teléfono 93 366 1200
 Fax 93 419 4501
 www.roca.es

Roca

**902
304
848**  LÍNEA DE ATENCIÓN AL CONSUMIDOR ESPAÑA