

MÜLLTONNENBOX FÜR 4 TONNEN ANTHRAZIT

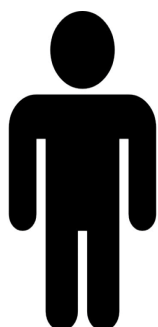

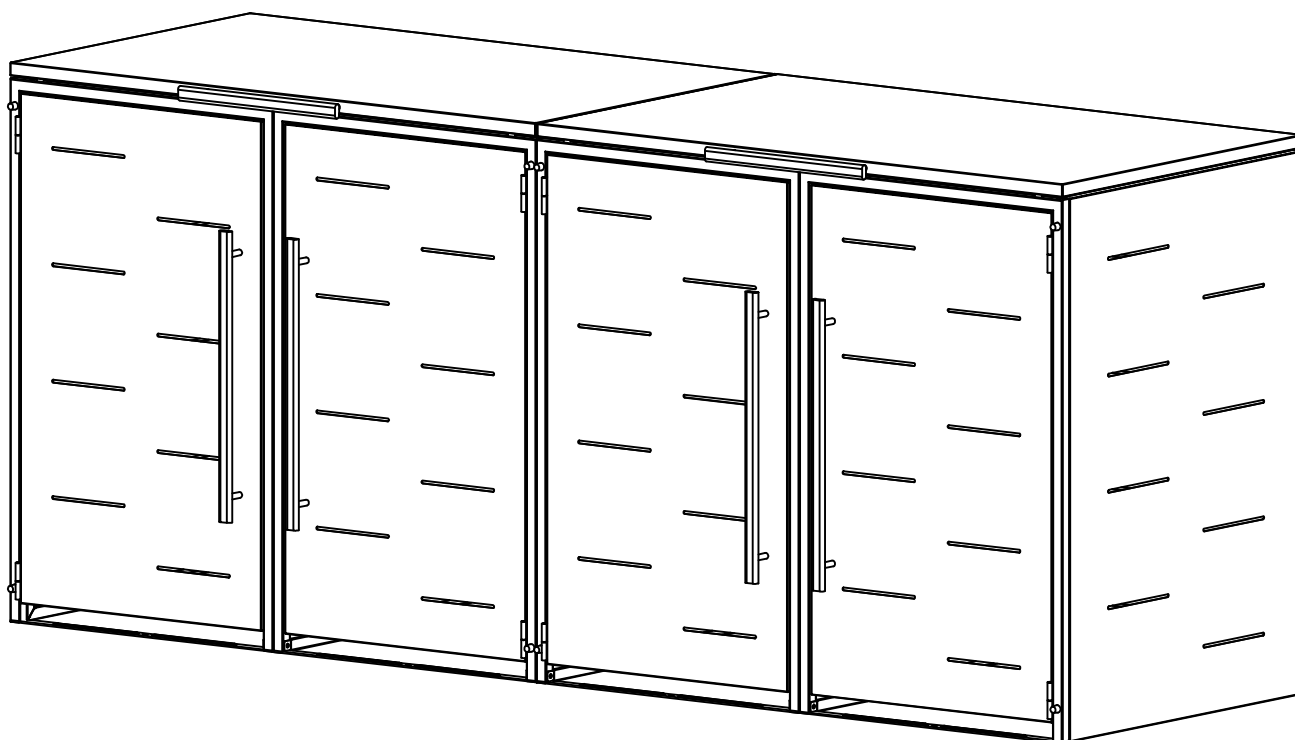

BAHAG: 31715021





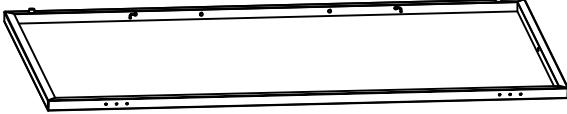
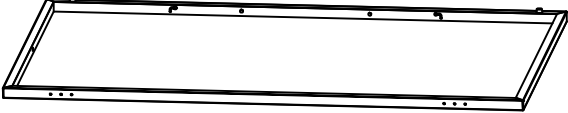
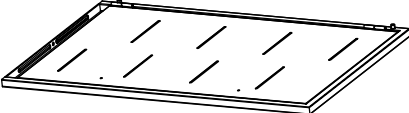
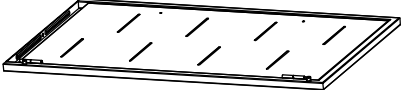

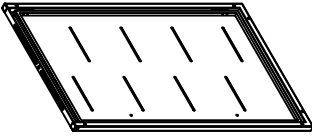
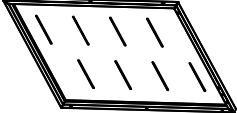
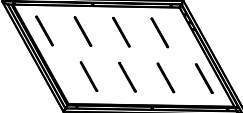
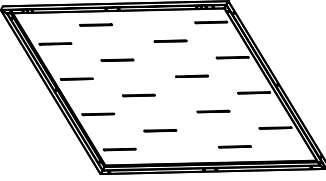
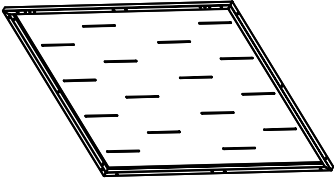



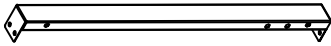
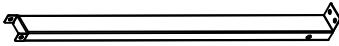

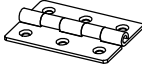



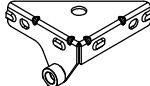
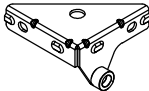





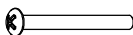

3

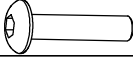
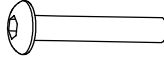
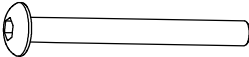

150 min

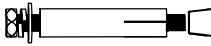
	Bauteile Nummer	Bezeichnung / Abbildung	Menge	
	A1		1	
	A2		1	
	B1		1	
	B2		1	
	C1		1	
	C2		1	
	D1		1	
	D2		1	
	E1		1	
	E2		1	
	F		2	
	G		2	

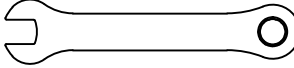
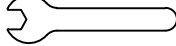
	Bauteile Nummer	Bezeichnung / Abbildung	Menge	
	H		1	
	I		1	
	J		4	
	K		4	
	L		4	
	M		2	
	N		4	
	O		3	
	P		12	
	P1		2	
	P2		2	
	Q		4	
	R		4	
	S1	 $\varnothing 16 * \varnothing 6.5 * 15$	4	
	S2	 $\varnothing 15 * \varnothing 6.5 * 17$	4	
	T	 $\varnothing 13 * \varnothing 6.5 * 2$	16	
	AA	 M4*35	24	
	BB	 M6*15	72	

	Bauteile Nummer	Bezeichnung / Abbildung	Menge
	CC	 M6*35	12
	DD	 M6*40	12
	EE	 M6*65	6
	FF	 M4	24
	GG	 M6	6
	HH	 $\varnothing 8.8 * \varnothing 4 * 1$	24
	II	 M6*60	8
	JJ		2
	KK		1
	LL		1
	MM		1

GB: Please have the following ready for assembly

DE: Halten Sie für den Aufbau bitte Folgendes bereit

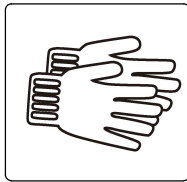
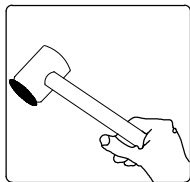
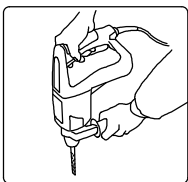

GB: NOTE: Please follow power tool's manufacturer instruction when in use.

DE: HINWEIS: Bitte beachten Sie bei der Verwendung von Elektrowerkzeugen die Anweisungen des Herstellers.

GB: Disposal: Please follow your municipal disposal instructions for your collection containers.

DE: Entsorgung: Bitte beachten Sie Ihre kommunalen Entsorgungshinweise für Ihre Sammelbehälter.

STEP 1

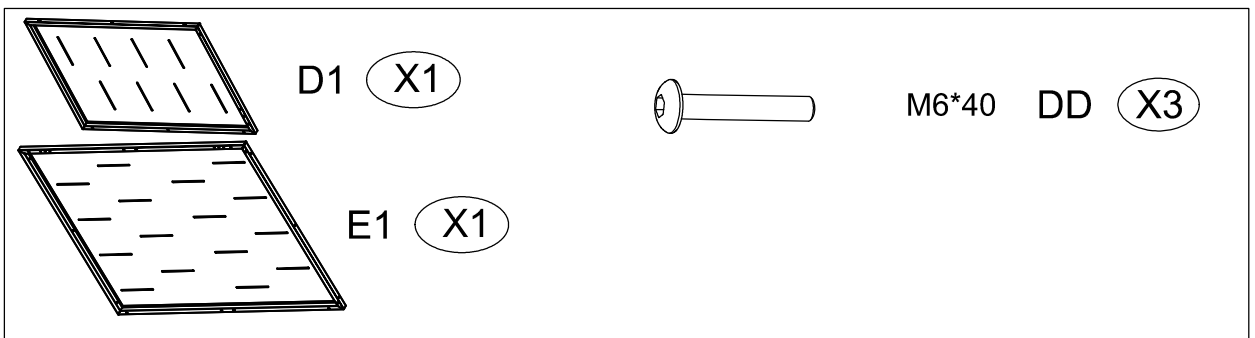
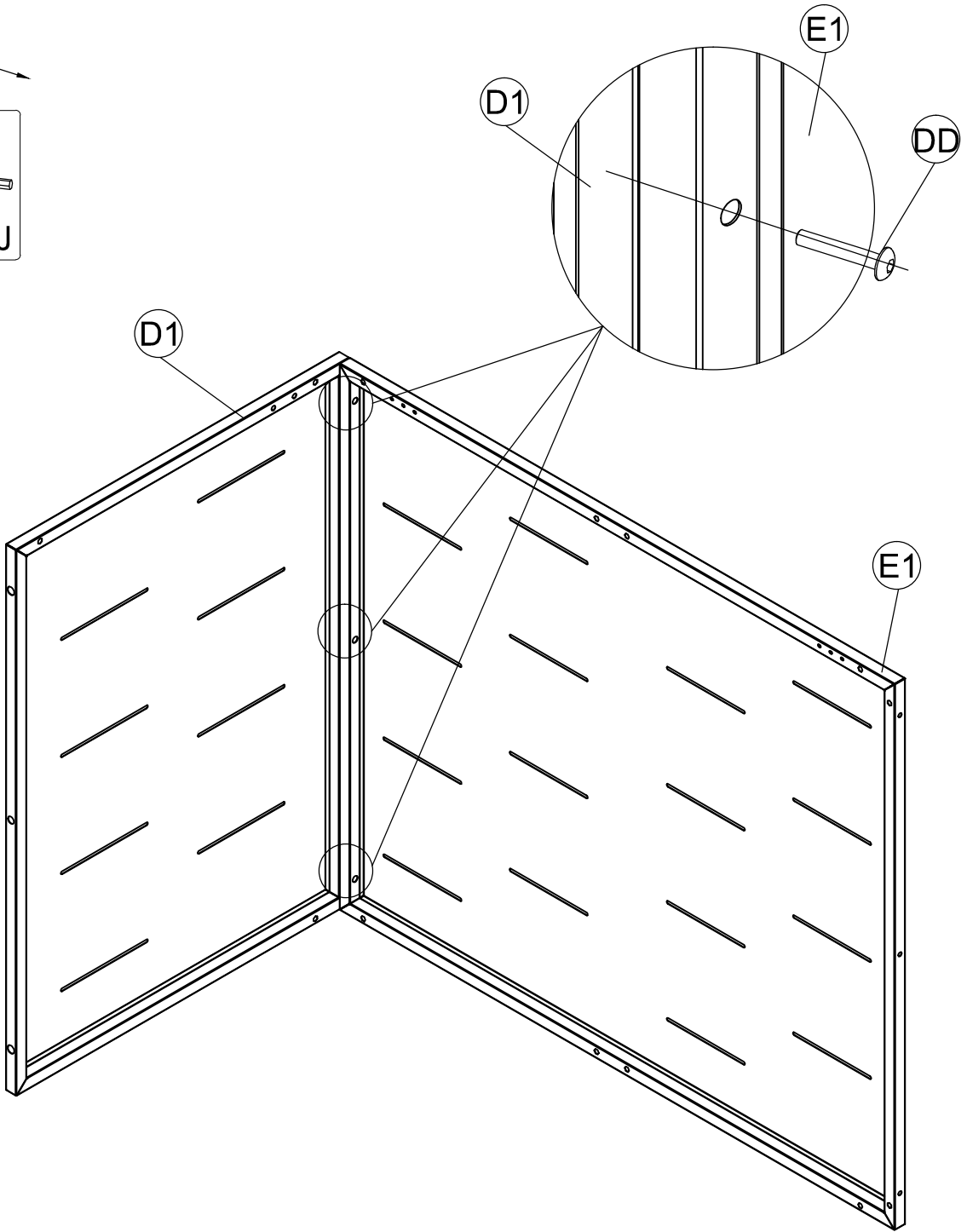
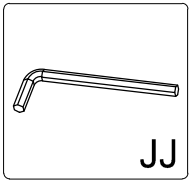

STEP 2

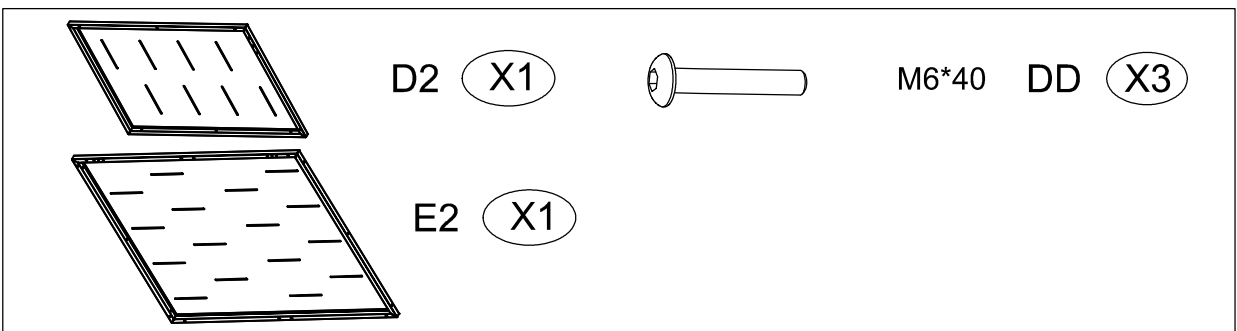
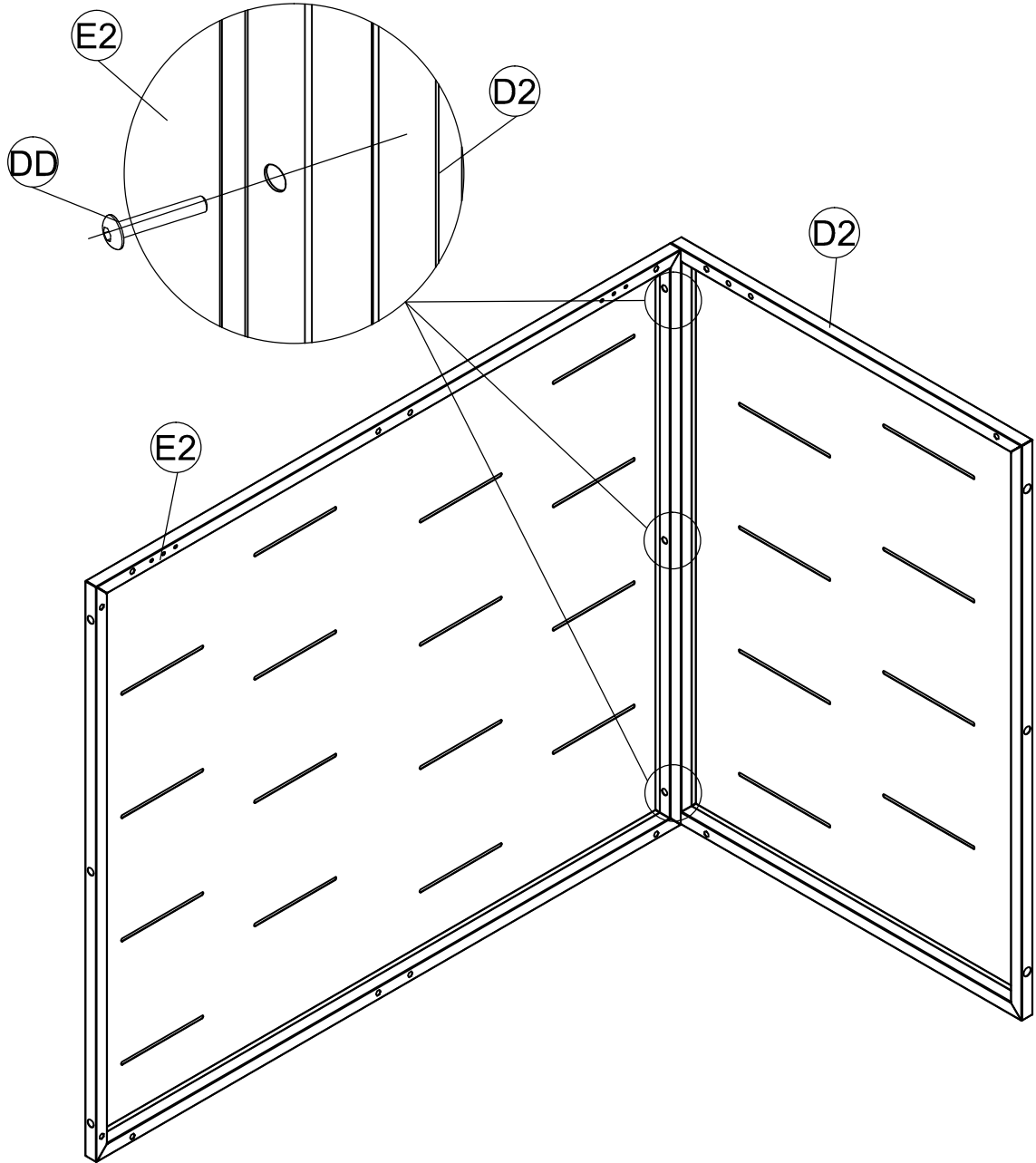
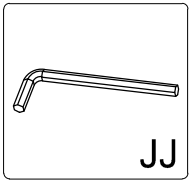

STEP 3

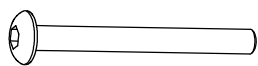
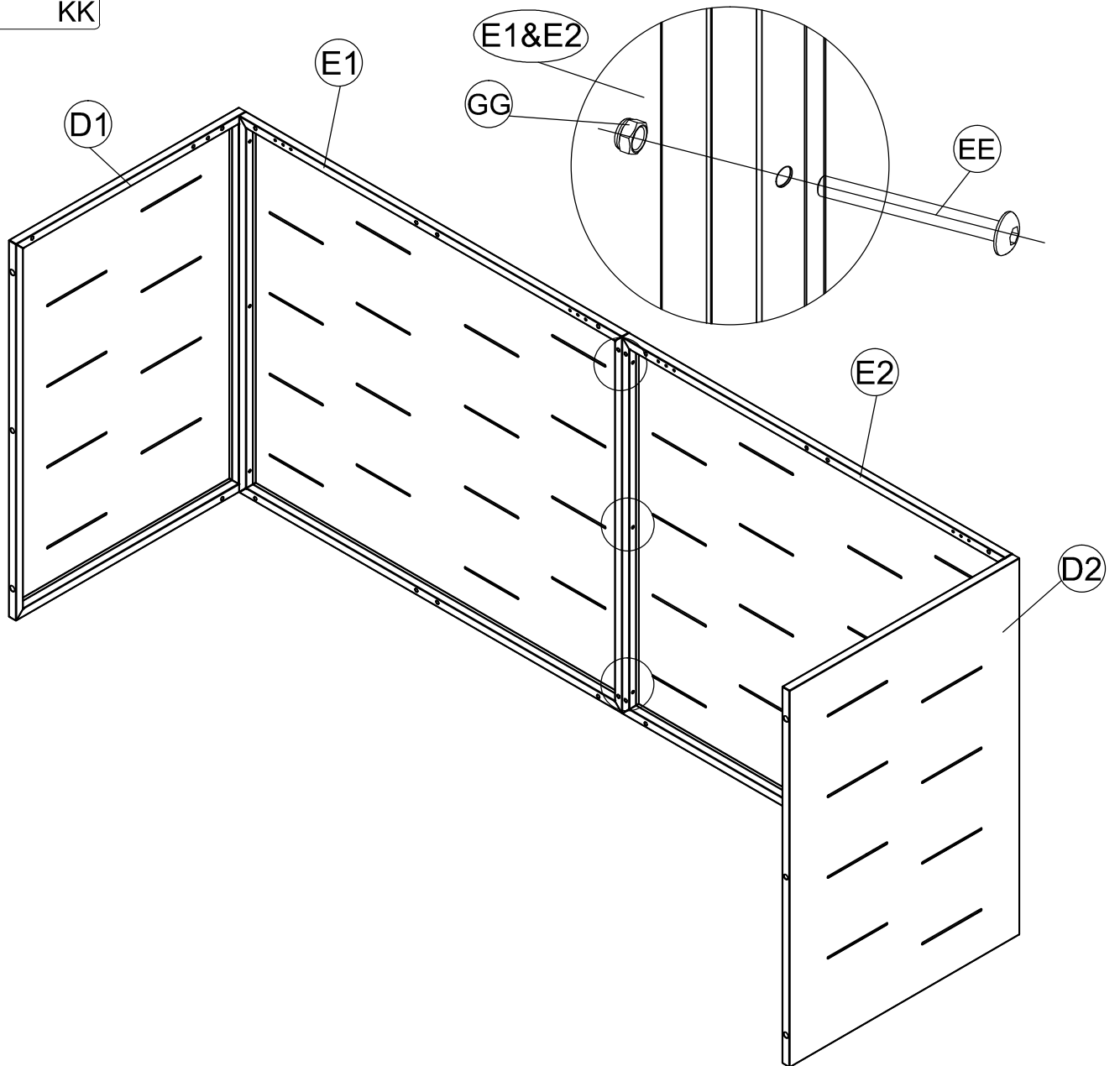
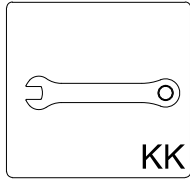
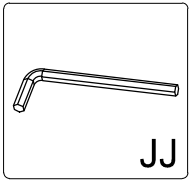

M6*65

EE

X3



M6

GG

X3

STEP 4

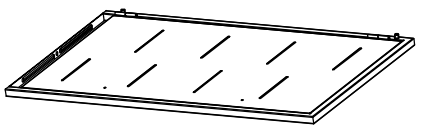
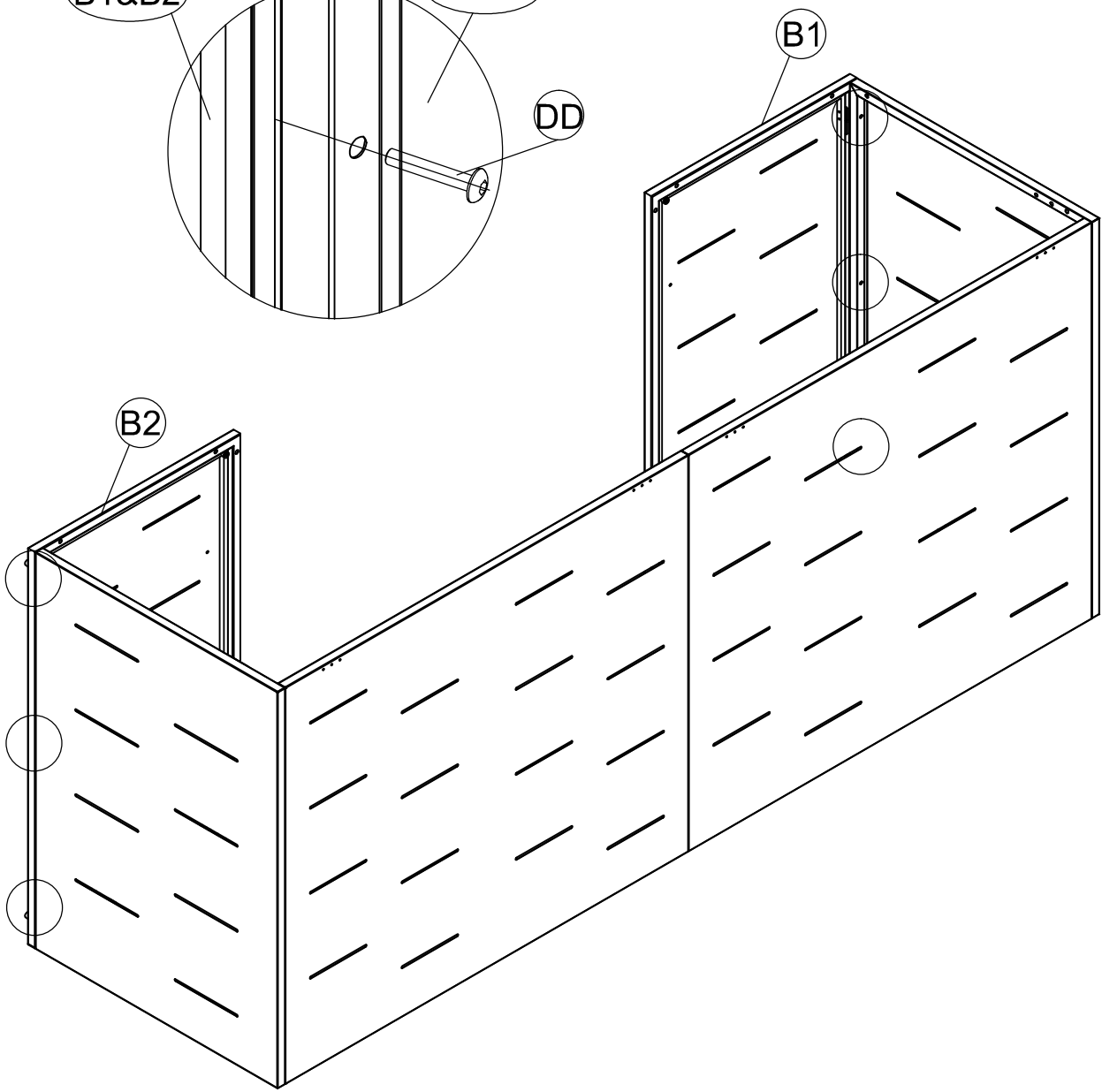
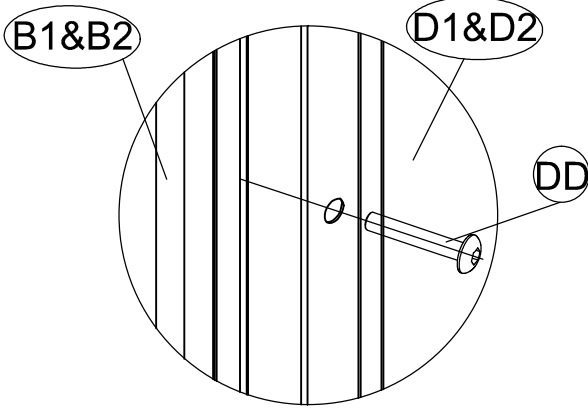
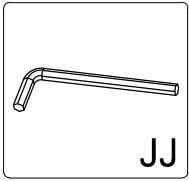

B1 (X1)

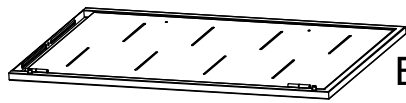

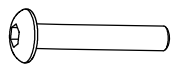

B2 (X1)

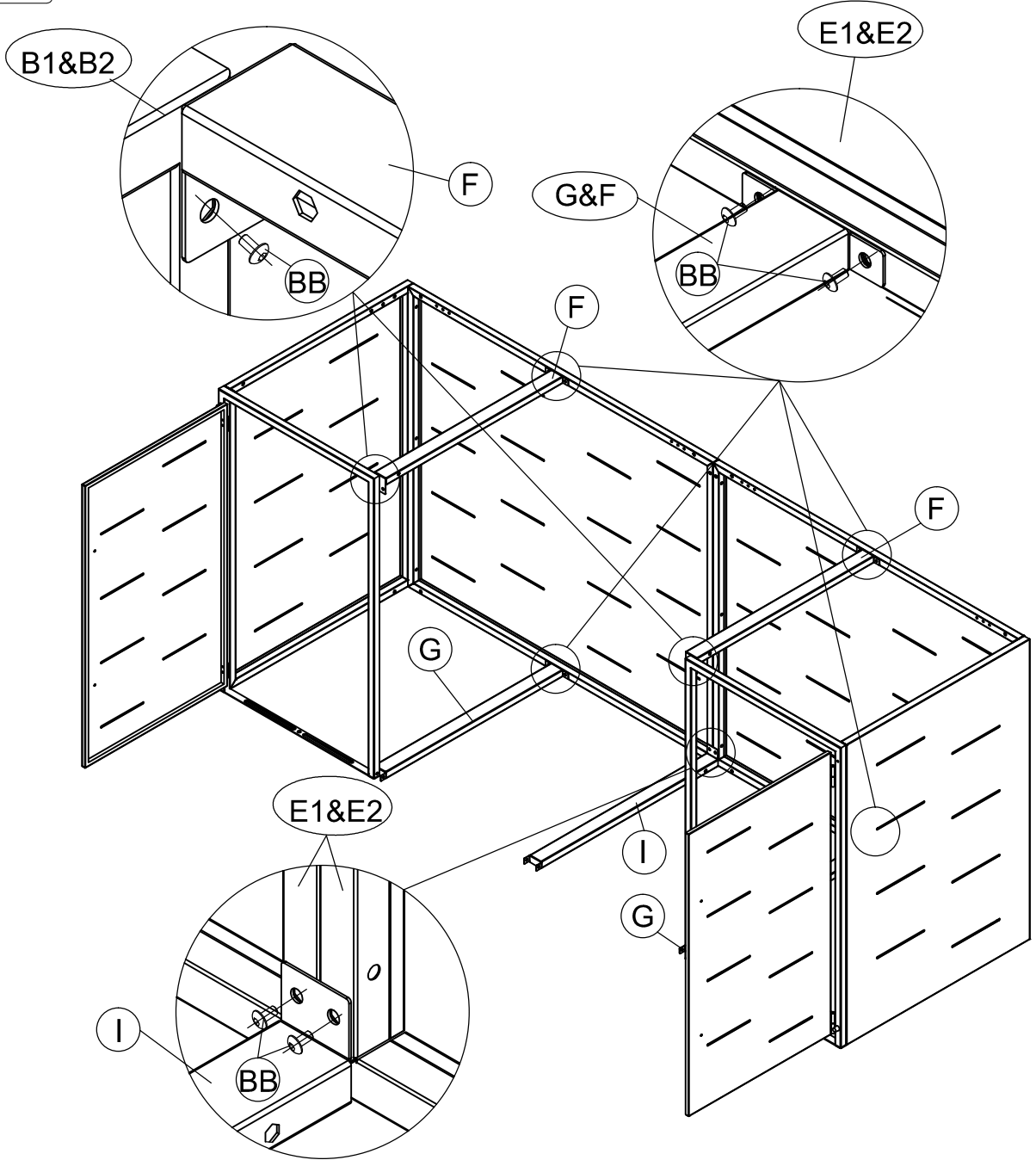
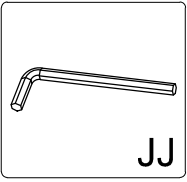

M6*40 DD (X6)

STEP 5

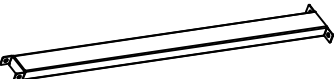
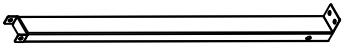

	G	X2		I	X1	
	F	X2		M6*15	BB	X12

STEP 6

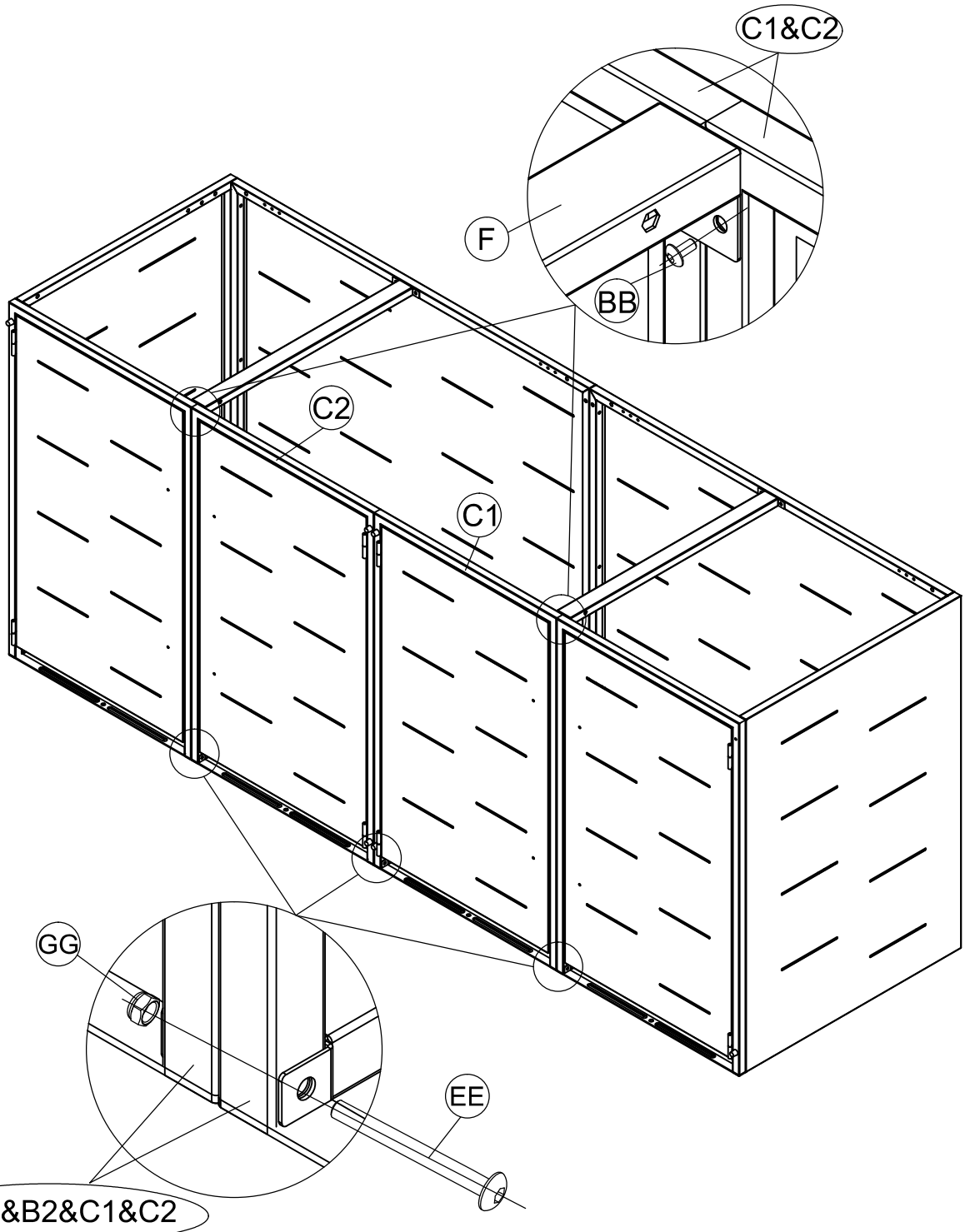
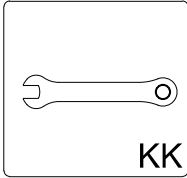
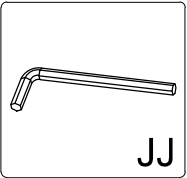

X1

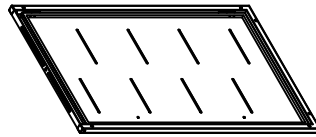

X1



M6*15

X2



M6

X3

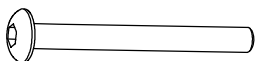

M6*65

X3

STEP 7

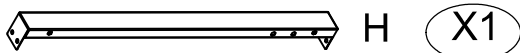
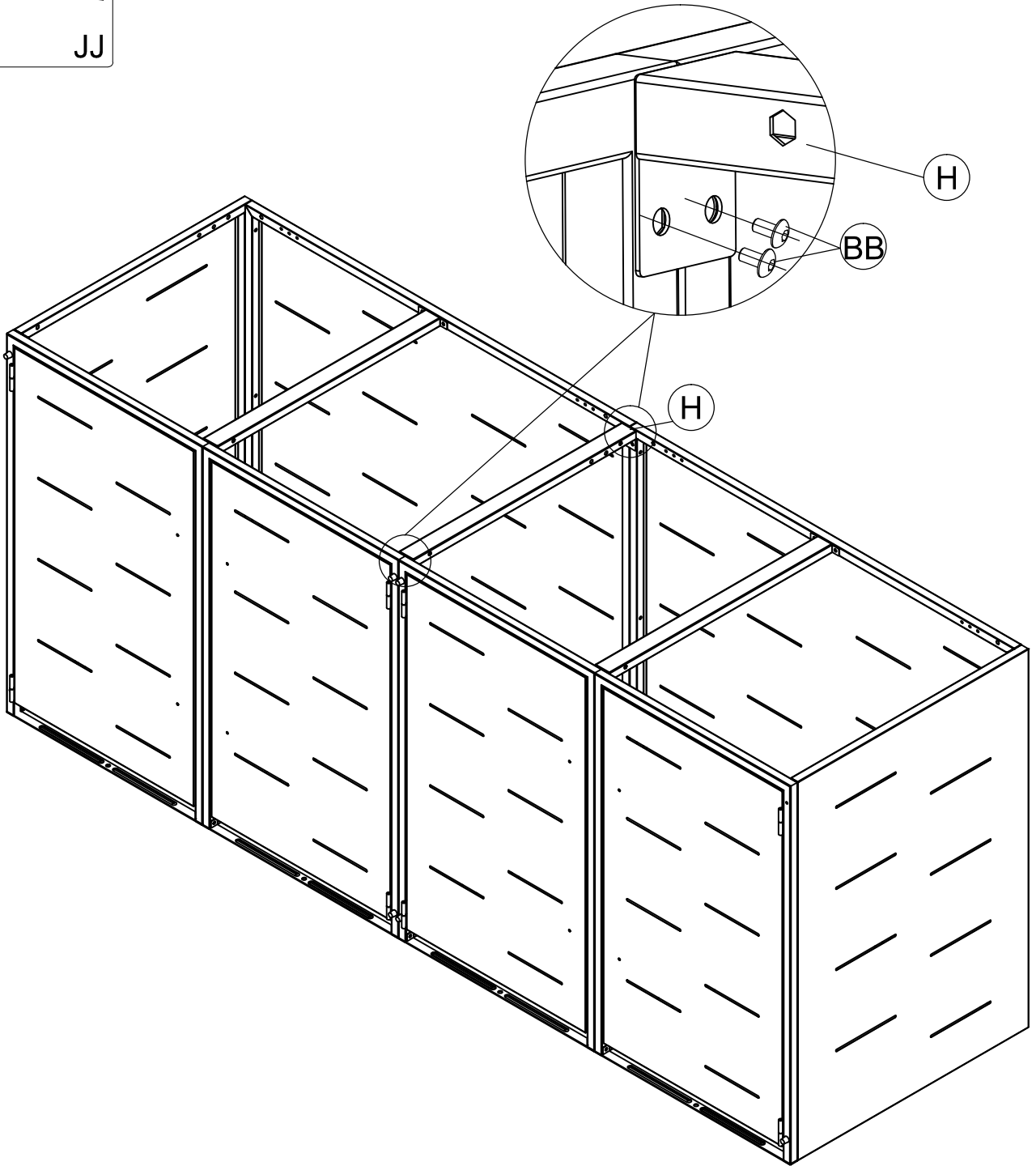
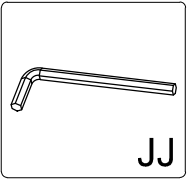

H X1



M6*15 BB X12

STEP 8

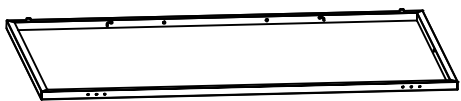
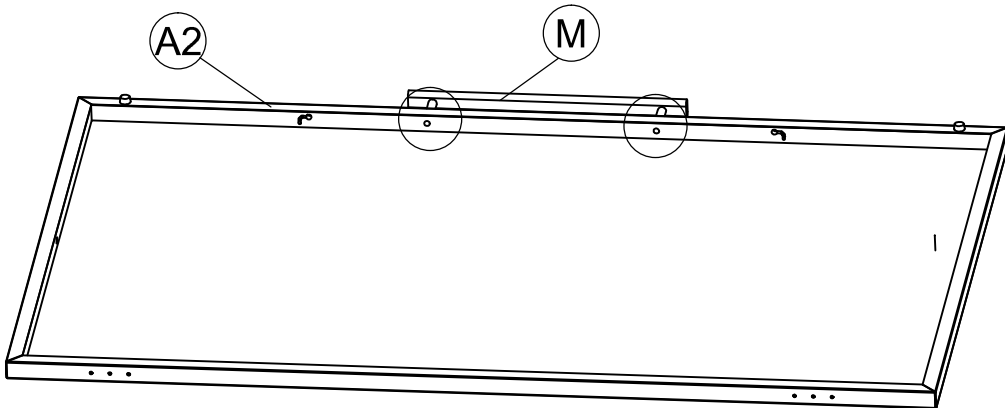
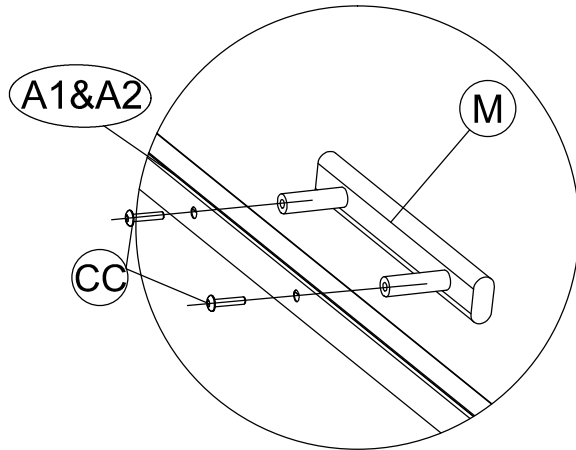
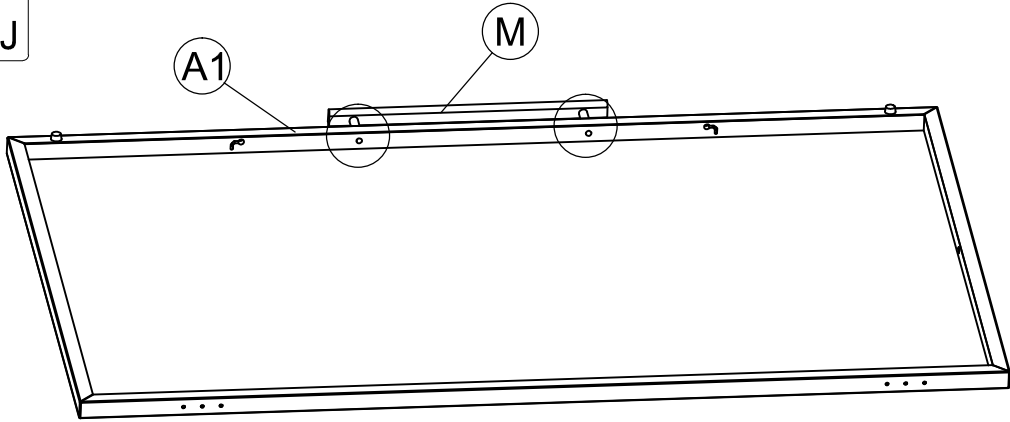
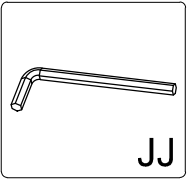

A1 X1



M X2

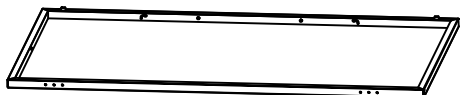

A2 X1

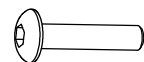

M6*35

CC X4

STEP 9

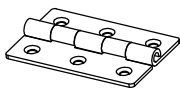
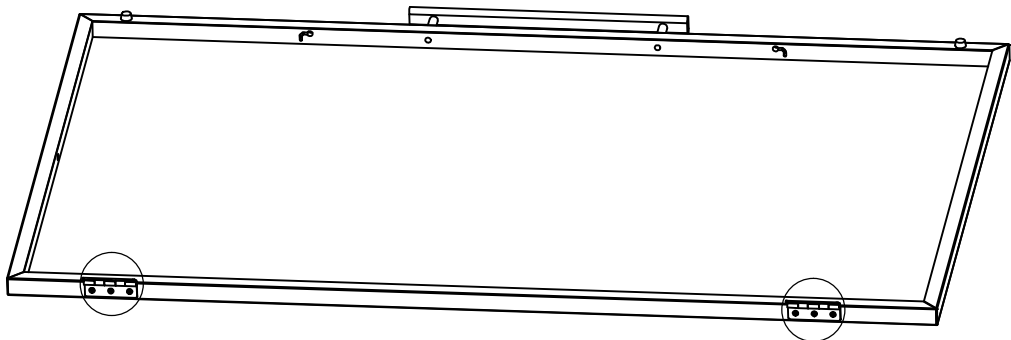
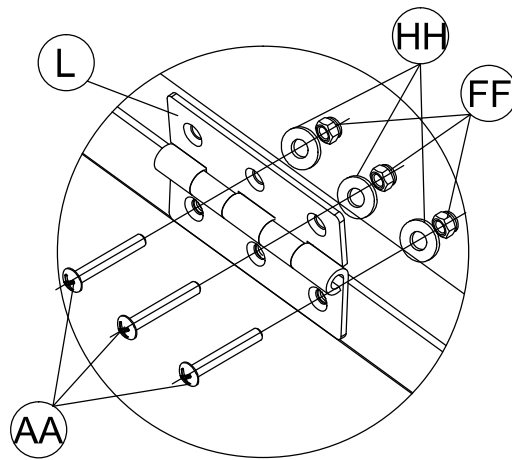
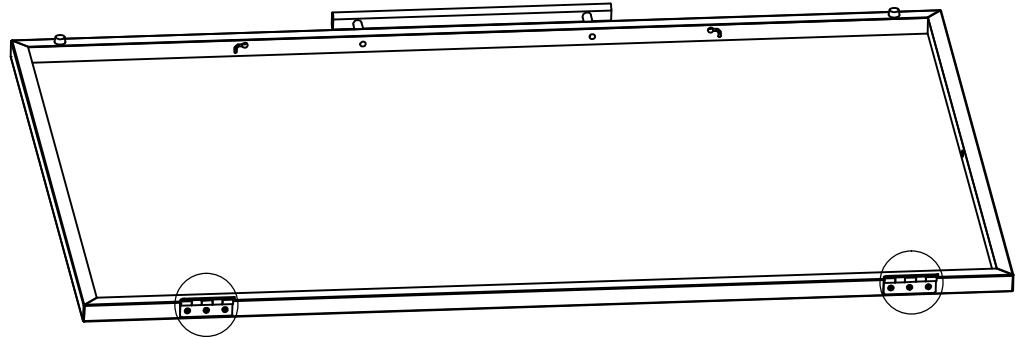
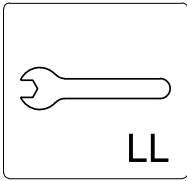
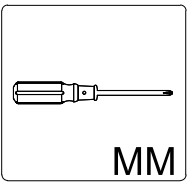

L (X4)

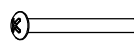

M4*35

AA (X12)



M4

FF

(X12)





Ø8.8*Ø4*1

HH (X12)

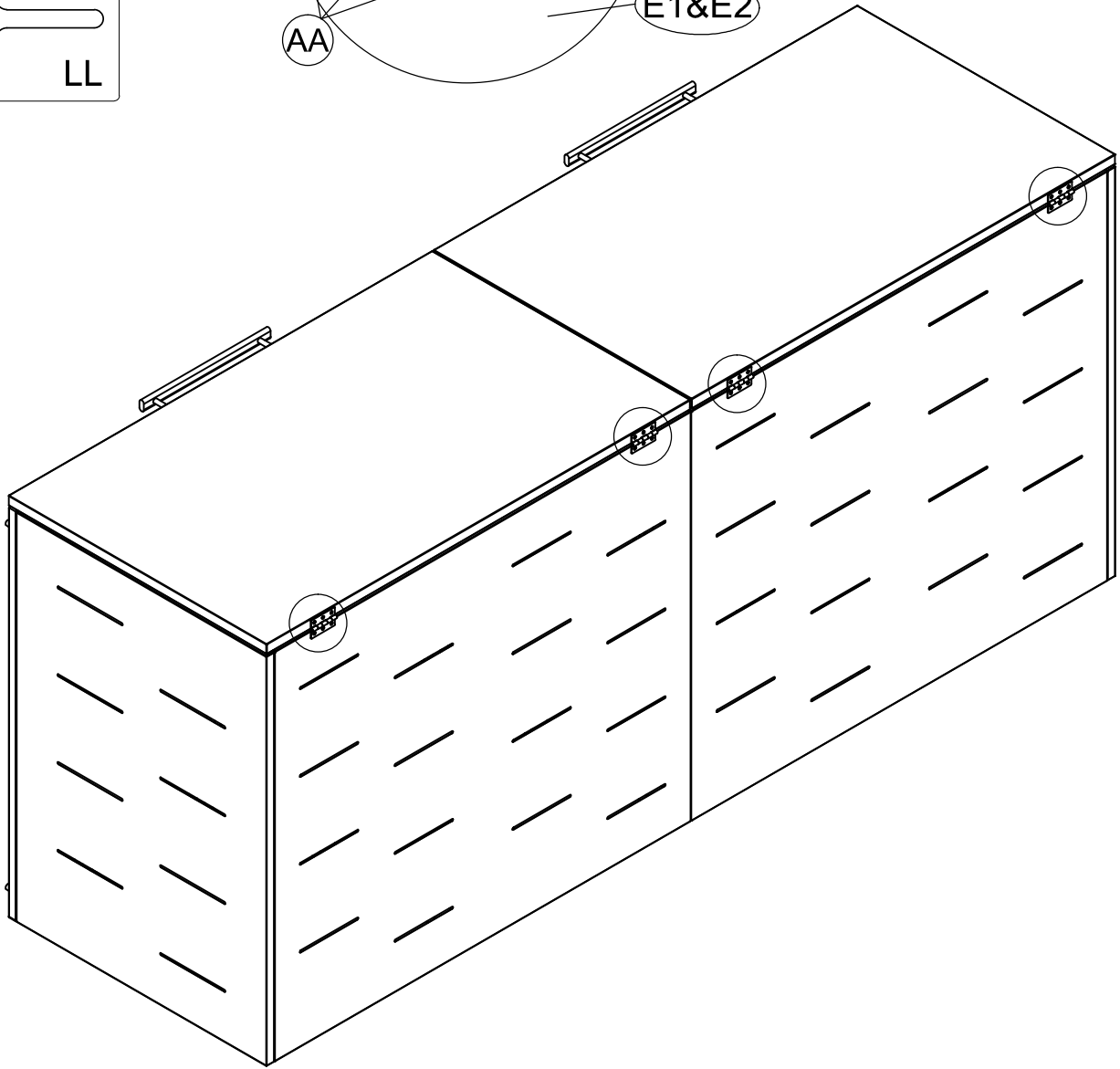
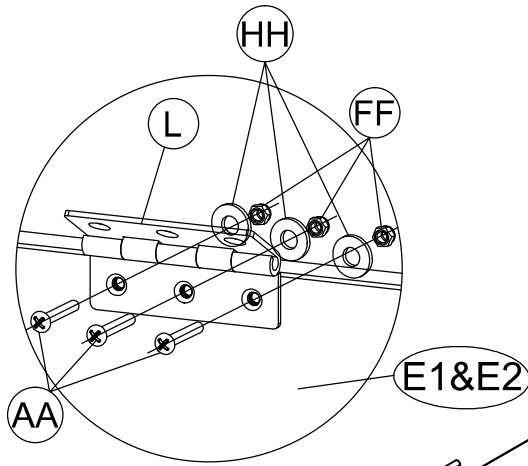
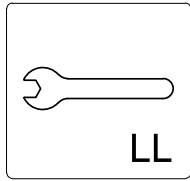
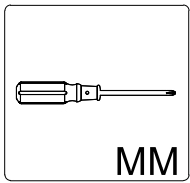
STEP 10



	M4*35	AA	(X12)		M4	FF	(X12)
	Ø8.8*Ø4*1	HH	(X12)				

STEP 11

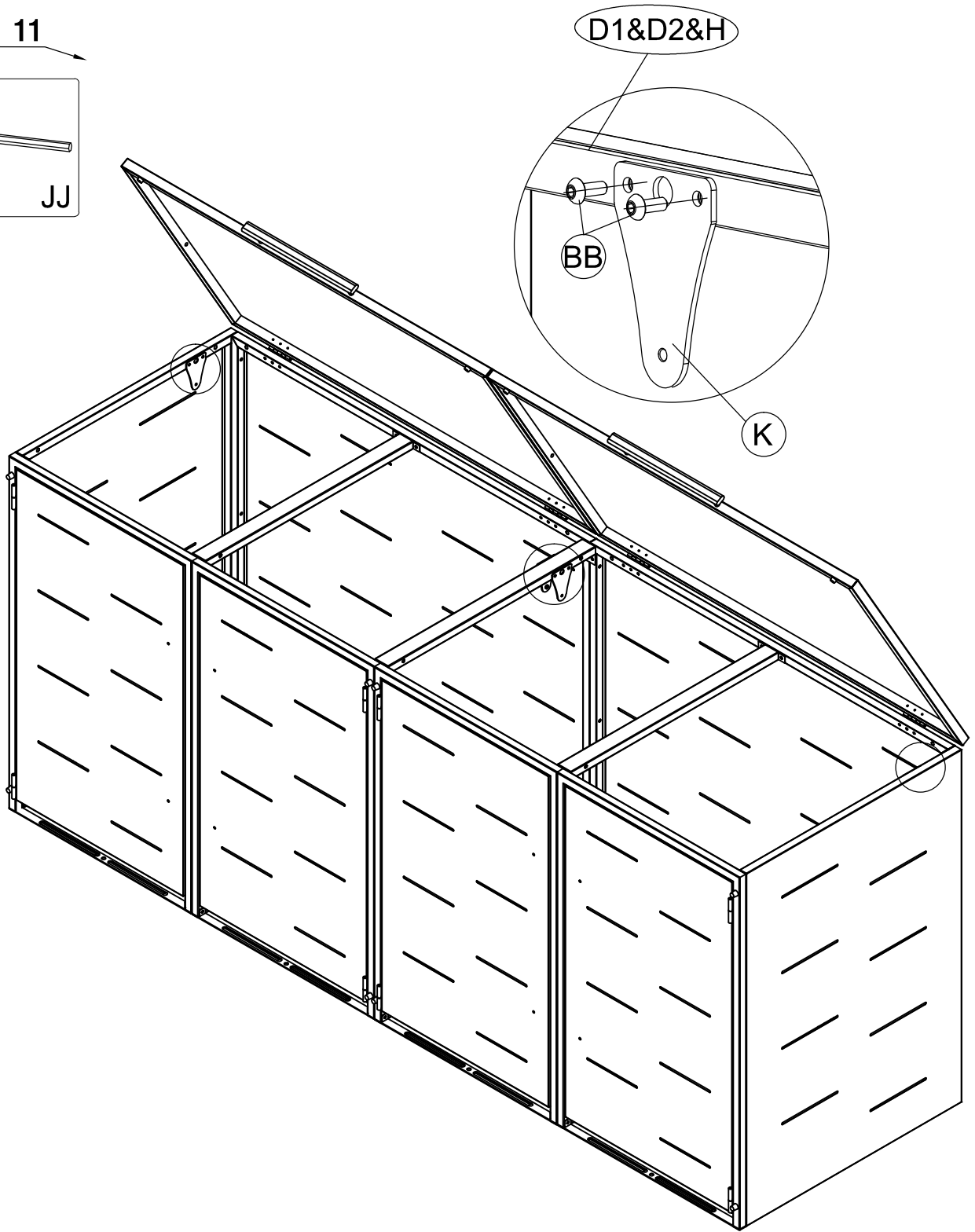
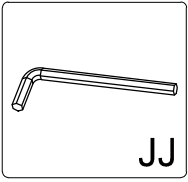



K X4

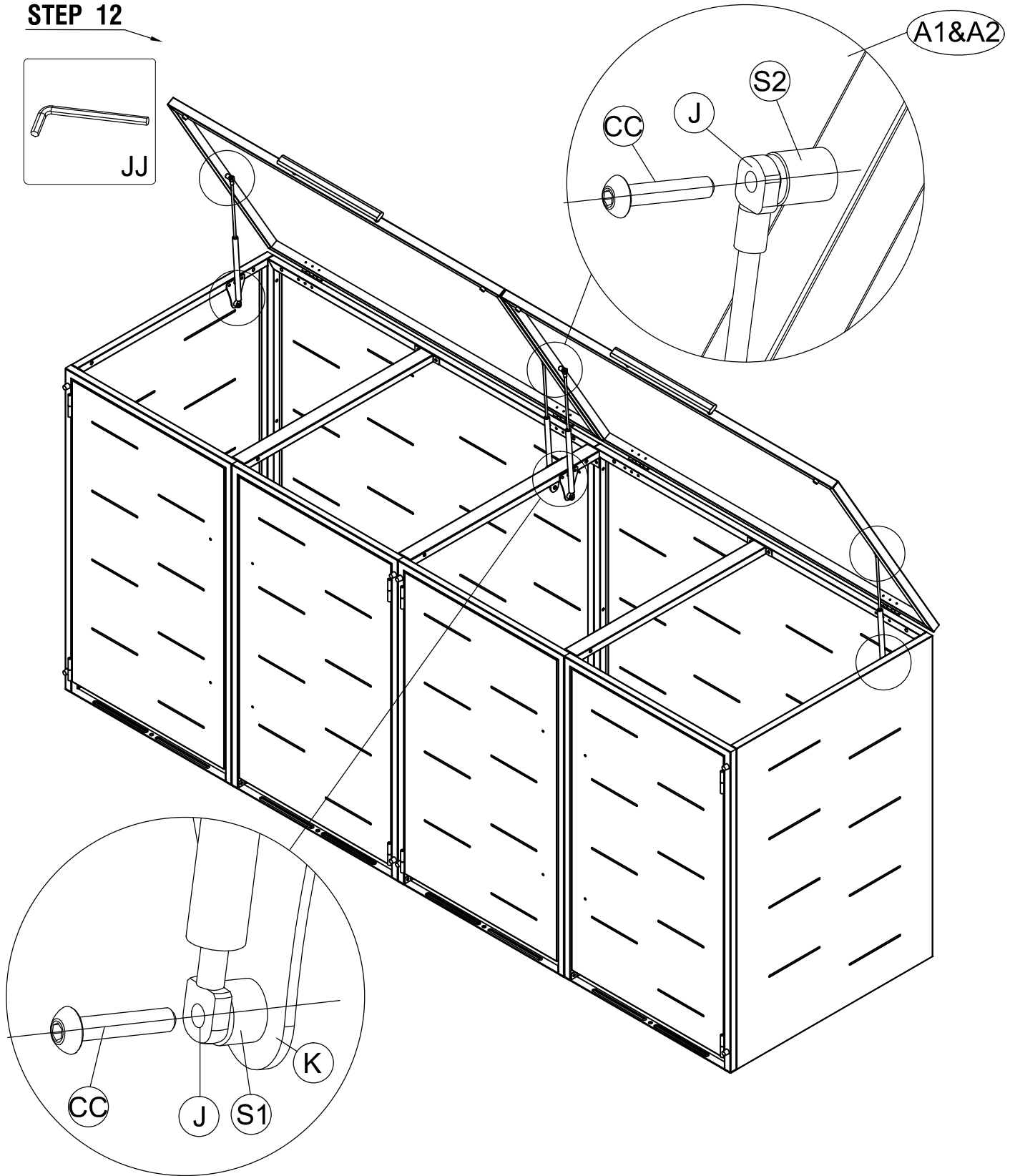
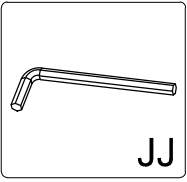

M6*15 BB X8

STEP 12

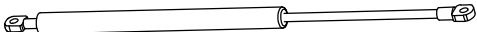

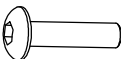
	J (X4)		∅16*∅6.5*15	S1 (X4)	
	∅15*∅6.5*17	S2 (X4)		M6*35	CC (X8)

STEP 13

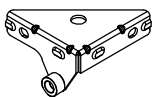
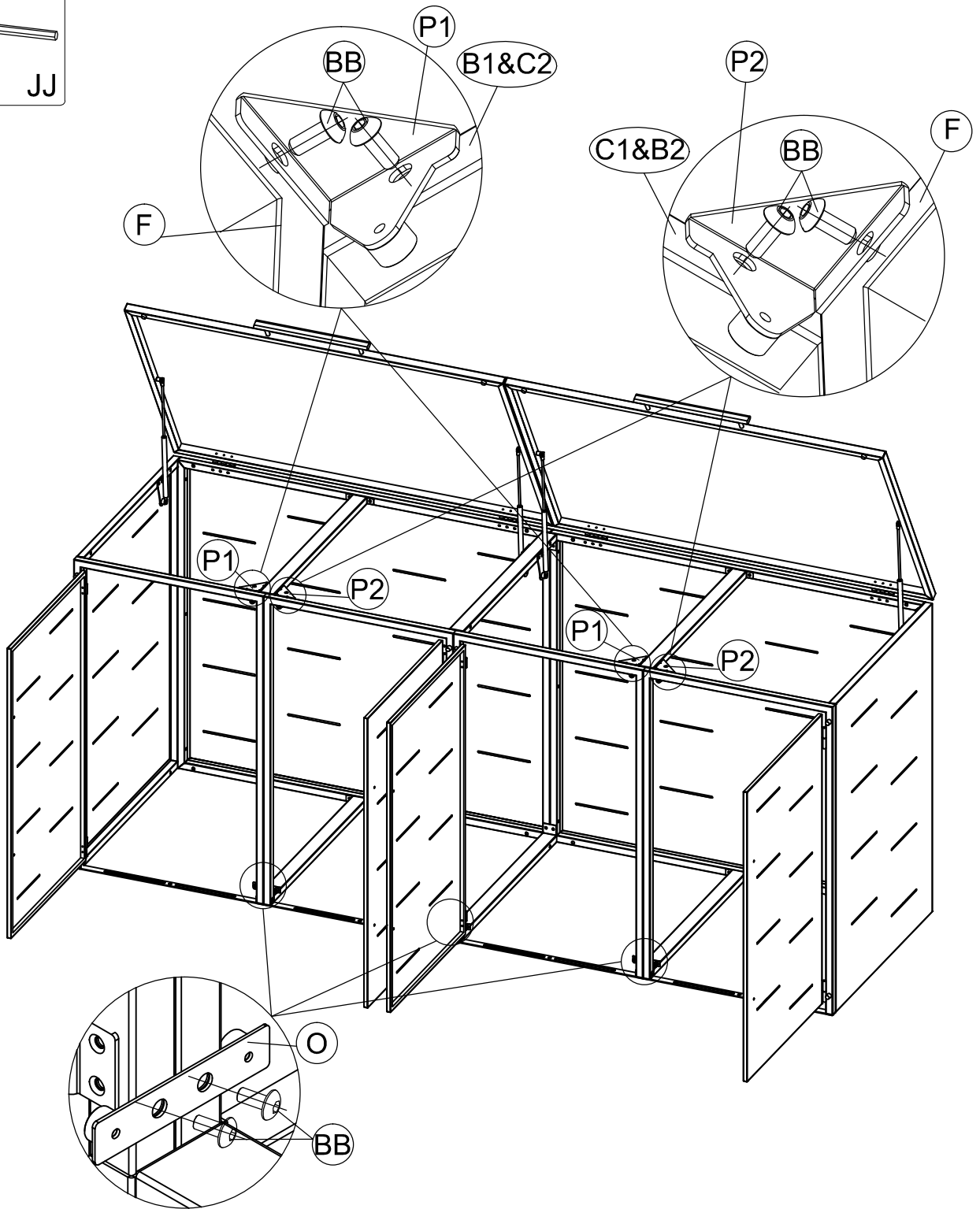
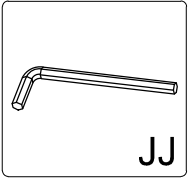

P1

X2

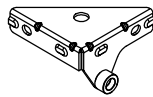

P2

X2



M6*15

BB

X14



O

X3

STEP 14

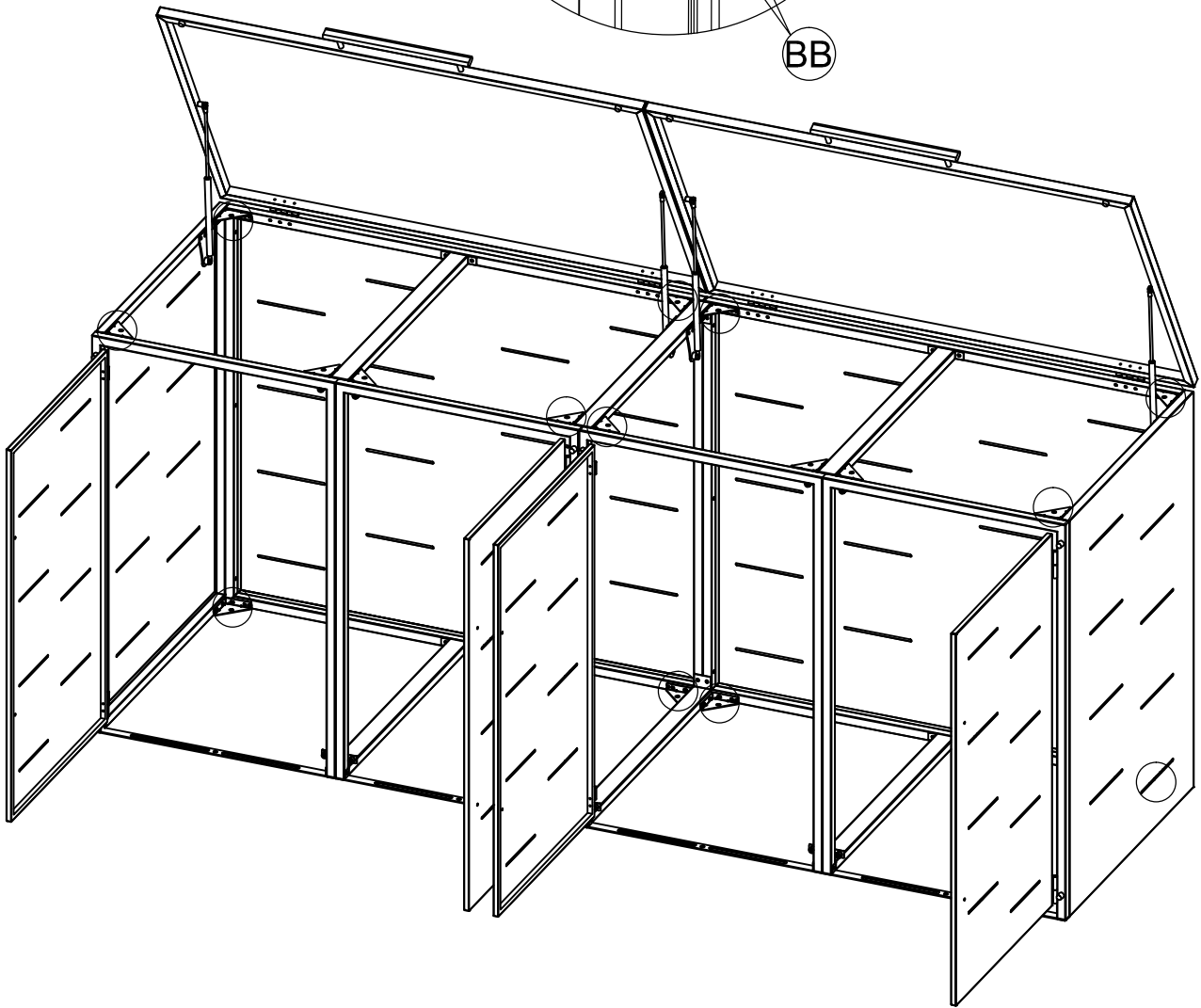
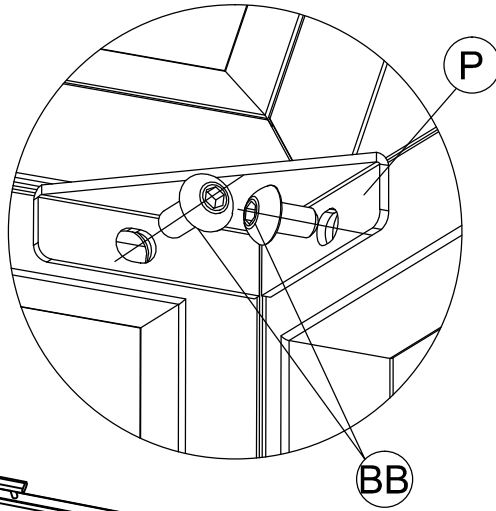
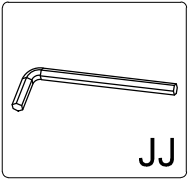

P

X12



M6*15

BB

X24

STEP 15

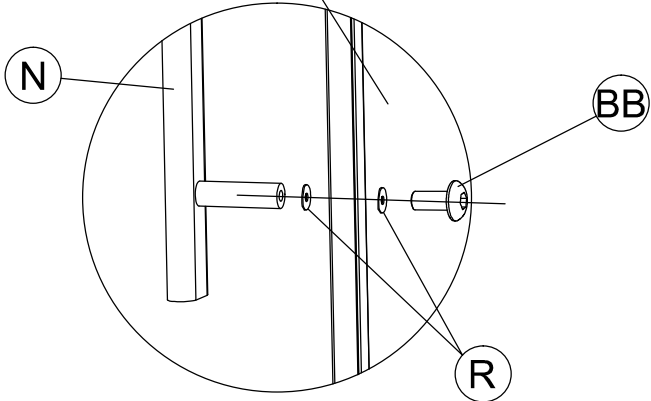
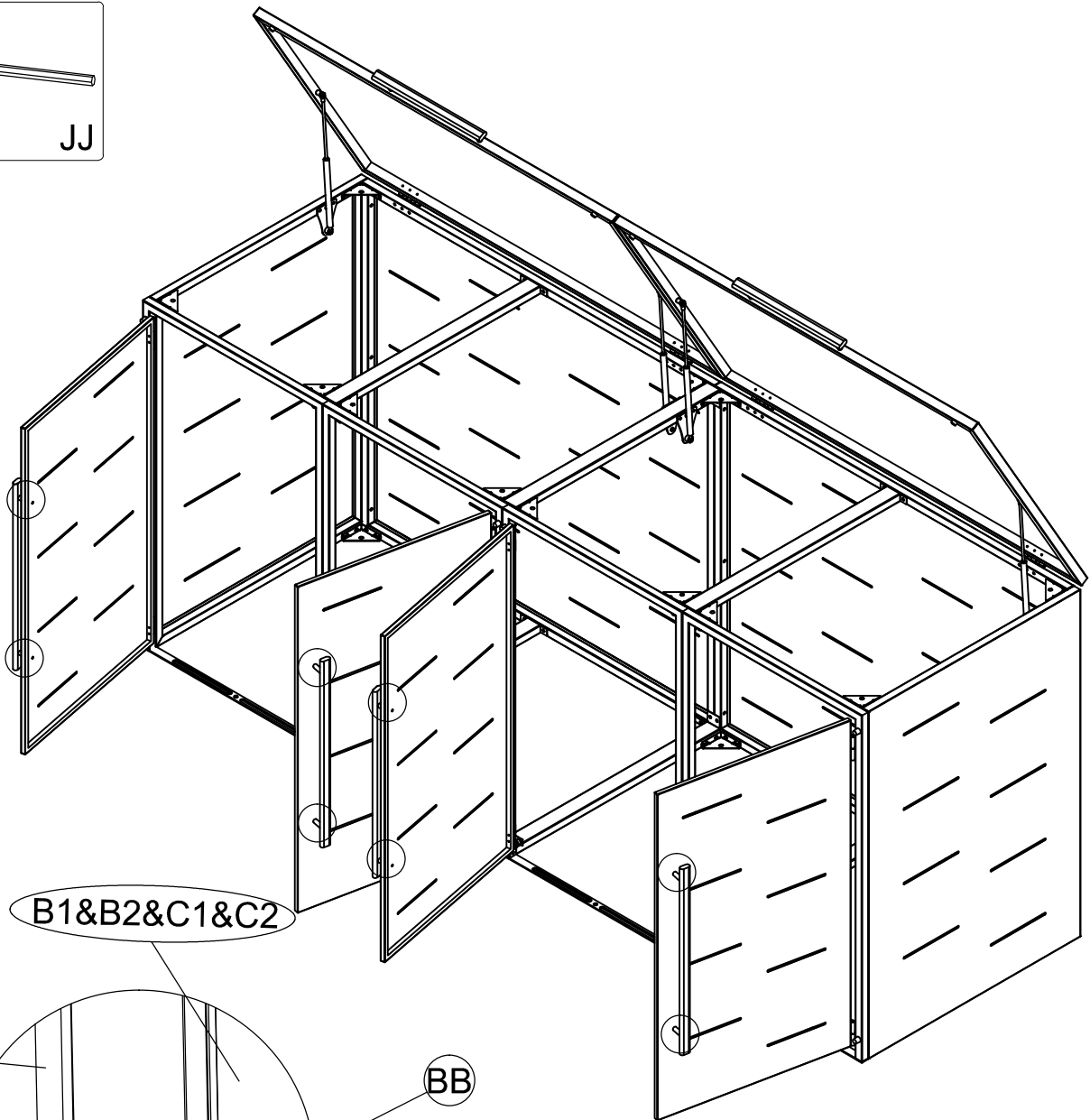
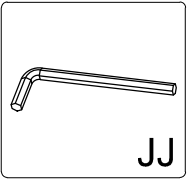

	N	X4		M6*15	BB	X8
	∅13*∅6.5*2	T	X16			

STEP 16

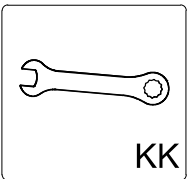
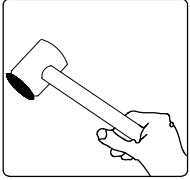
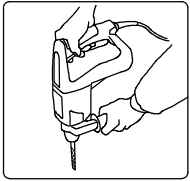

KK

GB • The product must be stable on a fixed, level surface, preferably on concrete or stone slabs. If there is no suitable base, you need to create a foundation. Anchor the construction tightly to the ground.

- Ensure storm-proof anchoring to the ground and always lock the doors! Do not set up in windy conditions!
- Snow Clearance: Regularly clear snow during winter months.

DE • Das Produkt muss auf einem festen, ebenen Untergrund stehen, vorzugsweise auf einer Beton- oder Steinplatte. Ist kein geeigneter Untergrund vorhanden, müssen Sie ein Fundament erstellen. Verankern Sie die Konstruktion fest im Boden.

- Sorgen Sie für eine sturmsichere Bodenverankerung und schließen Sie die Türen immer ab! Nicht bei Wind aufstellen!
- Schneeräumung: Regelmäßige Schneeräumung in den Wintermonaten.

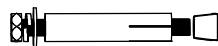
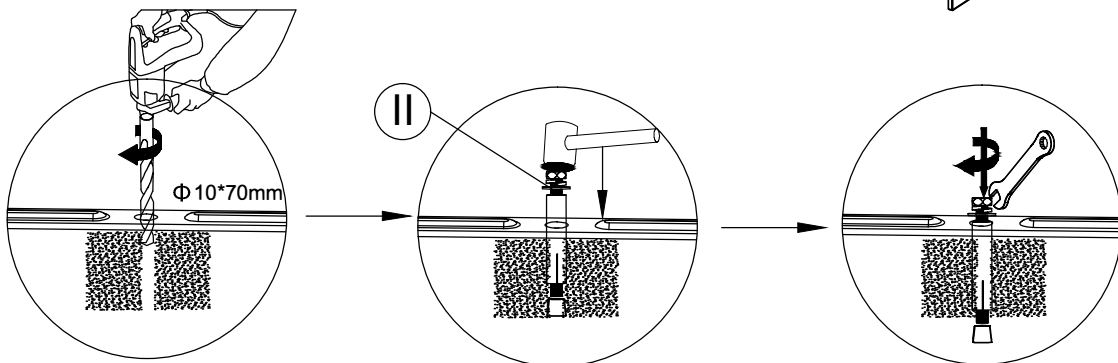
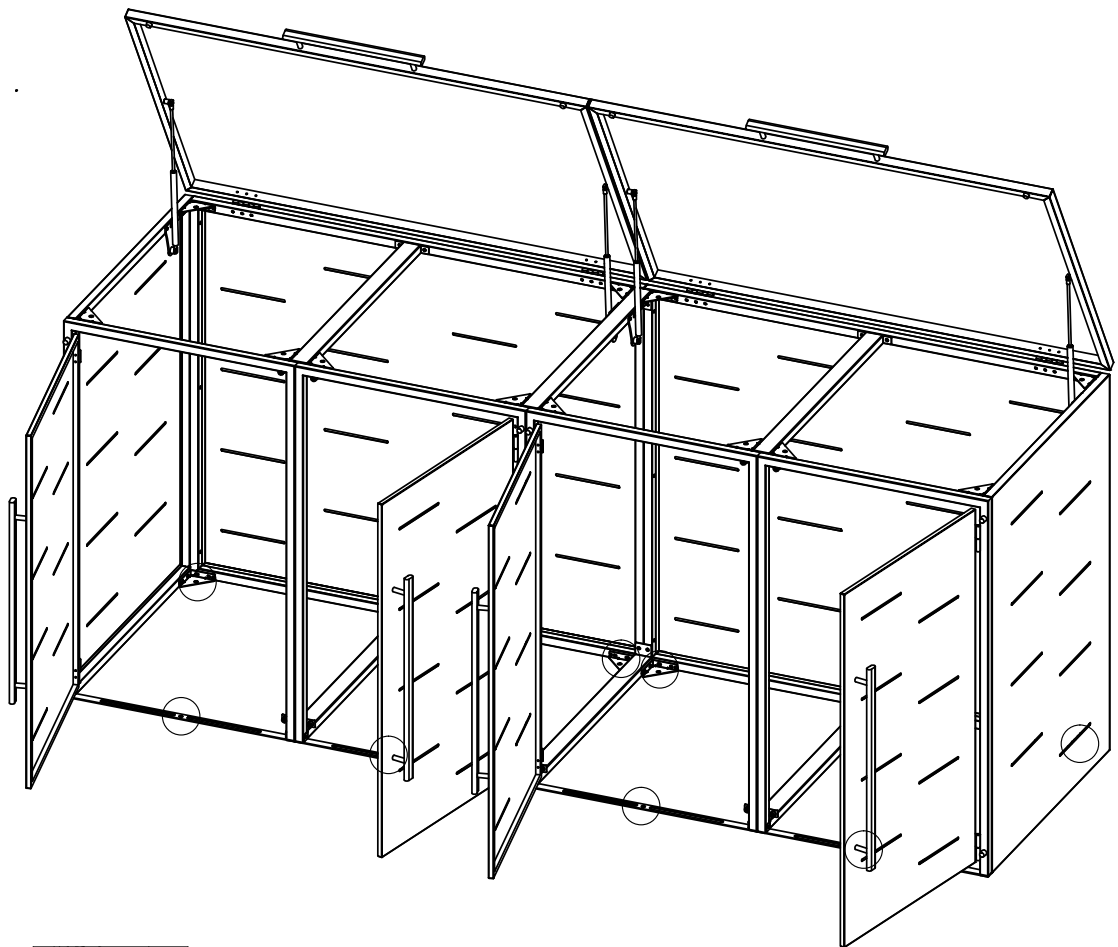

M6*60

II

X8

STEP 17

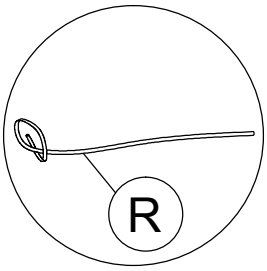

Step1

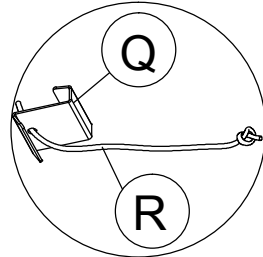

Step2

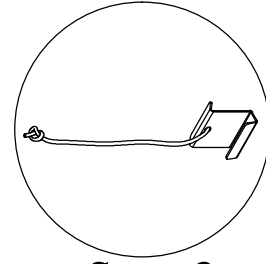

Step3

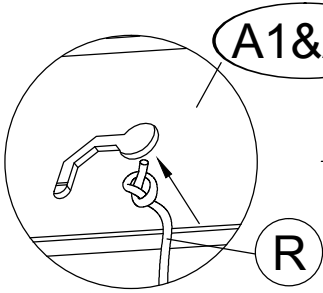

Step4

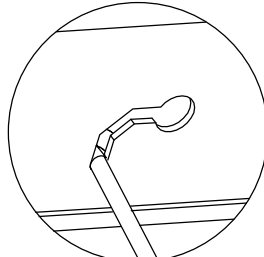
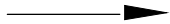

Step5

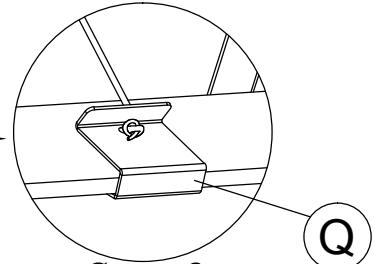
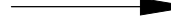

Step6

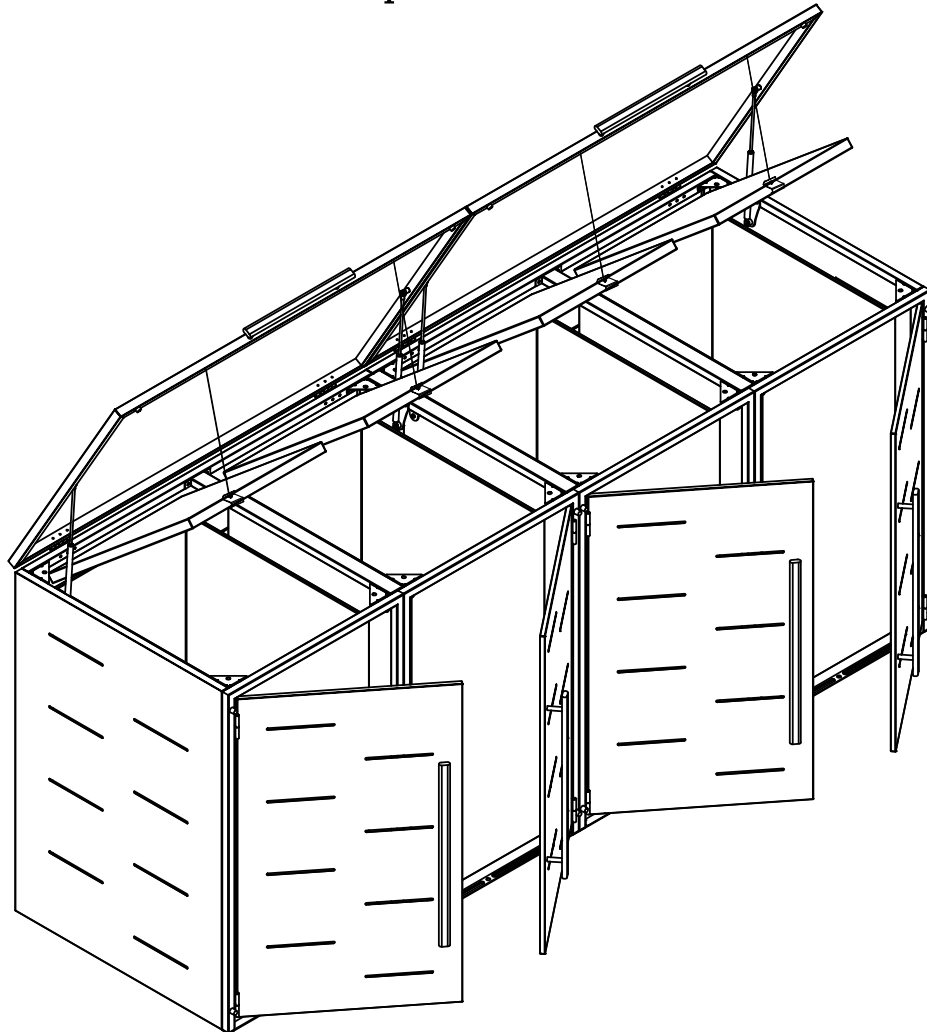

Q

X4



R

X4