



Twig è prodotto e distribuito da Alce S.r.l.
Via Bosa, 9 Luzzara (RE)
tel 0522/976798 fax 0522/979850
info@alceweb.com - www.alceweb.com



Information relating to the provision of packaging of this product, frame the QR to understand how to differentiate.



ISTRUZIONE DI MONTAGGIO ASSEMBLY INSTRUCTIONS MONTAGEANLEITUNG INSTRUCTIONS DE MONTAGE

CASETTA BH20 - 146x98 cm p.s. Fosb Posb
GARDEN SHED BH20 - 146x98 cm p.s. Fosb Posb
GARTENHAUS BH20 - 146x98 cm p.s. Fosb Posb
ABRI DE JARDIN BH20 - 146x98 cm p.s. Fosb Posb

COD. 62176ISTR

Inspection Certificate

Kontrollschein • Bulletin de contrôle • Certificato di controllo •
Certificado de control

Please keep safely!

Bitte gut aufbewahren! • A bien conserver, s.v.p.! • Da conservare! •
¡Para conservar!

English: The house you have purchased was manufactured in accordance with the high quality norms. The building unit has been carefully inspected and packed. In order to avoid possible problems during the assembly carried out by yourself or the building company of your choice, we recommend that you inspect the delivery for its completeness in accordance with the list of pieces before assembly. This inspection must be carried out within 14 days after delivery to your place. Warranty claims are limited to the exchange of defective materials. Defective building parts, which have already been used or painted, are excluded from being replaced. All further claims are excluded! In cases of complaints, please pay attention to the following procedures: Please present this inspection certificate along with the sales receipt to your place of purchase. Only in cases where these documents are presented will the complaint be dealt with quickly and without complications.

Deutsch: Das von Ihnen gekaufte Produkt wurde nach hohen Qualitätsnormen gefertigt. Der Bausatz wurde sorgfältig geprüft und verpackt. Um etwaige auftretende Probleme während des Aufbaus durch Sie oder Ihre Aufbaufirma zu vermeiden, kontrollieren Sie bitte die Lieferung auf Vollständigkeit laut der Stückliste vor dem Aufbau. Diese Kontrolle muss innerhalb von 14 Tagen nach Anlieferung bei Ihnen erfolgen. Ansprüche auf Gewährleistung beschränken sich auf den Austausch von fehlerhaftem Material. Fehlerhafte Bauteile, die bereits verbaut oder gestrichen wurden, sind vom Umtausch ausgeschlossen. Alle weiteren Ansprüche sind ausgeschlossen. Sollte es zu einer Beanstandung kommen, beachten Sie folgende Vorgehensweise: Legen Sie Ihrem Händler diesen Kontrollschein zusammen mit dem Einkaufsbeleg vor. Nur bei Vorlage dieser Unterlagen ist eine schnelle und problemlose Bearbeitung Ihrer Beanstandung möglich.

Français: La cabane que vous venez d'acheter a été fabriqué en respectant de hautes normes de qualité. L'ensemble de construction a été testé et emballé avec soin. Afin d'éviter des problèmes éventuels pendant la construction par vous-même ou la société de construction mandatée, nous vous prions de bien vouloir vérifier que toutes les pièces ont été fournies selon la liste des pièces avant que vous ne commenciez la construction. Il vous incombe de faire ce contrôle dans les 14 jours après la fourniture. Les revendications en dédommagement se limitent à l'échange de matériel défectueux. Des pièces de construction défectueuses, déjà construites ou peintes, sont exclues de tout échange. Toutes les revendications ultérieures sont exclues ! Si une réclamation avait lieu, veuillez respecter le déroulement suivant : Il vous faudra présenter, à votre commerçant spécialisé, ce bulletin de contrôle avec le récépissé de l'achat. Ce ne sera que moyennant présentation de ces documents qu'un traitement rapide et sans problème de votre réclamation sera possible!

Italiano: La casetta che avete acquistato è stata prodotta secondo le norme di alta qualità. Il kit è stato controllato ed imballato con cura. Per evitare eventuali inconvenienti durante il montaggio, si prega di verificare, prima del montaggio, la completezza della fornitura in base alla distinta dei pezzi. Tale verifica deve essere effettuata entro 14 giorni dalla consegna. Eventuali diritti di garanzia si limitano alla sostituzione di materiale difettoso. Gli elementi difettosi già montati o verniciati sono esclusi dal diritto alla sostituzione. Ogni altro diritto resta escluso! In caso di reclamo, procedere nel modo seguente: presentare questo certificato di controllo unitamente alla prova d'acquisto al rivenditore. Solo in questo modo il Suo reclamo potrà essere evaso rapidamente e senza problemi.

Español: La casa que ha adquirido ha sido fabricado de acuerdo con las normas de alta calidad. La construcción de la unidad ha sido cuidadosamente inspeccionada y embalada. Con el fin de evitar posibles problemas durante la montaje llevada a cabo por usted o la empresa de construcción de su elección, le recomendamos que inspeccione la entrega de acuerdo con la lista de las piezas antes del montaje. Esta inspección deberá realizarse dentro de los 14 días después del parto a su lugar. Las reclamaciones de garantía se limita al intercambio de materiales defectuosos. La construcción de partes defectuosas, que ya han sido utilizados o se pintan, no pueden ser reemplazados. Todas las otras reclamaciones están excluidos! En los casos de quejas, por favor, preste atención a los siguientes procedimientos: Por favor presente este certificado junto con el recibo de venta a su lugar de compra. Sólo en los casos en que estos documentos se presentan a la denuncia se resuelva de forma rápida y sin complicaciones.

To be completed by buyer! (Please use block letters) • Vom Käufer auszufüllen! (Bitte in Druckschrift) • A remplir par l'acheteur! (en lettres d'imprimerie, s'il vous plaît) • Da compilare dall'acquirente! (in stampatello) • Rellena el cliente (en mayusculas por favor) :

Place of purchase • Bezugsquelle • Source
d'achat • Acquistato presso • Lugar de compra :

.....
.....
.....

Sales receipt No. • Kaufbeleg-Nr. • Récépissé n°

• Prova d'acquisto N. • N° recibo:

Delivery date • Lieferdatum • Date de livraison •

Data di consegna • Fecha de entrega:

Buyer's address • Kundenanschrift • Adresse du client • Indirizzo del cliente •
Dirección del cliente:

.....
.....
.....

Telephone • Telefon • Téléphone • Telefono:

Sales receipt date • Kaufbeleg-Datum • Date du récépissé • Data prova

d'acquisto • Fecha recibo :

Forwarder: Pick-up Others • Durch: Spedition Selbstabholer •

Par: Transporteur Propres moyens • Tramite: Spedizioniere Mezzo proprio

• Entrega: Transporte organizado transporte de cliente

Description of complaint • Schilderung der Beanstandung • Description de la réclamation • Descrizione del reclamo •

descripción de queja: **(Please keep the parts which are the object of the complaint until the complaint is settled! • Bitte die reklamierten Teile aufheben, bis die Reklamation erledigt ist! • Veuillez garder les pièces contestées jusqu'à ce que la réclamation soit traitée définitivement! • Si prega di conservare i pezzi contestati del reclamo!)** • Por favor mantiene todas detalles reclamadas hasta que la queja se ha resuelto.

INDICAZIONI GENERALI

Gentile Cliente,

la ringraziamo per aver scelto la nostra casetta in legno.

E' importante leggere accuratamente le istruzioni prima di dare inizio alle operazioni di montaggio del prodotto, in tal modo eviterà qualsiasi problema e perdita di tempo.

Consigli:

- Conservare il kit in luogo asciutto e non appoggiato direttamente sul pavimento, mantenendolo protetto da agenti atmosferici (acqua, sole ecc.) fino al montaggio definitivo. Non conservare il prodotto in ambienti riscaldati.
- Nella scelta del luogo in cui sarà posizionata la casetta, prestare attenzione a che non sia esposta a condizioni atmosferiche estreme (zone esposte a vento forte).

Garanzia:

La vostra casetta è stata realizzata con pregiato legno di abete rosso nordico e viene consegnata non trattata. Qualora, nonostante il nostro accurato controllo in fabbrica, dovessero sorgere reclami sarà necessario presentare al negoziante il certificato di controllo compilato insieme alla fattura d'acquisto.

Esclusioni:

- Il legno è una materia prima naturale e pertanto le contestazioni relative al suo naturale comportamento non rientrano nella garanzia.
- Reclami relativi al materiale non vengono accettati una volta verniciato.
- Nodi nel legno.
- Scolorimenti del legno che non influiscono sulla durata.
- Crepe / fessure non passanti che non compromettono la costruzione.
- Deformazioni del legno, a condizione che possa ancora essere lavorato.
- Sui lati non visibili del tavolame del tetto e del pavimento sono ammesse parti non piallate; sono inoltre ammesse differenze di colore e di smusso.
- Reclami successivi dovuti a montaggio non conforme o cedimento della struttura della casetta a causa di fondamenta errate sono esclusi.

Le rivendicazioni di garanzia sono limitate alla sostituzione del materiale difettoso, ogni altra rivendicazione è esclusa.

VERNICIATURA, MANUTENZIONE E SMALTIMENTO

Il legno è un prodotto naturale e si muove in modo variabile. Caratteristiche quali venature grosse e sottili, sfumature e cambiamenti di colore nonché nodi sono dovuti alla crescita dell'albero. Sono del tutto normali nei legni che crescono all'aperto, e pertanto non sono da considerare difetti ma piuttosto una caratteristica del legno naturale.

Per la verniciatura, usare attrezzi e vernici di qualità e rispettare le istruzioni di sicurezza e applicazione del produttore della vernice. Non verniciare in pieno sole o in caso di pioggia. Farsi consigliare dettagliatamente dal venditore sulla protezione di legni di conifera trattati. Con una regolare verniciatura aumenterete notevolmente la durata della vostra casetta in legno. Consigliamo un'ispezione semestrale del prodotto.

Lubrificare con regolare frequenza le parti mobili quali serratura, cerniere e catenacci facendo attenzione a non imbrattare le parti circostanti.

A fine vita del prodotto provvedere a consegnare la **casetta** direttamente all'ECOCENTRO nel cassonetto del **LEGNO**. Oppure, nei comuni dove è previsto, mediante il ritiro rifiuti ingombranti.

L'azienda Alce s.r.l. si riserva la possibilità di apportare in qualsiasi momento e senza preavviso modifiche ai propri prodotti atte e migliorarne la qualità.

DE

GENERELLES

Sehr geehrter Kunde,

es freut uns, dass Sie sich für unser Produkt entschieden haben.

Es ist wichtig, diese Aufbauanleitung vollständig durchzulesen, bevor Sie mit dem Aufbau Ihres Produktes beginnen. So vermeiden Sie Probleme und unnötigen Zeitverlust.

Tipps:

- Lagern Sie den Bausatz bis zur endgültigen Montage trocken und nicht direkt auf dem Erdboden und geschützt vor Witterungseinflüssen (Nässe, Sonneneinwirkung, etc.). Die Produkte bitte nicht in einem geheizten Raum aufbewahren!
- Achten Sie bei der Standortwahl darauf, dass das Produkt nicht extremen Witterungsbedingungen (Gebiete mit starkem Wind) ausgesetzt ist.
- Achten Sie darauf, dass das Dach bei Schneefall regelmäßig vom Schnee befreit wird und somit keine Gefahr für das Produkt als auch für vorbeigehende Personen besteht.

Gewährleistung

Ihr Produkt besteht aus hochwertigem nordischen Fichtenholz und wird unbehandelt geliefert. Sollte es trotz unserer sorgfältigen Werkskontrolle zu Reklamationen kommen, legen Sie ihrem Händler den ausgefüllten Kontrollschein mit Ihrer Einkaufsrechnung vor!

Abweichungen, die keinen Reklamationsgrund darstellen:

- Holz ist ein Naturprodukt, daher fallen die naturgegebenen Beanstandungen nicht unter Garantie.
- Materialreklamationen werden nicht akzeptiert, wenn bereits ein Anstrich erfolgte
- Äste, die mit dem Holz fest verwachsen sind.
- Holzverfärbungen, ohne das dadurch die Lebensdauer beeinflusst wird.
- Risse /Trockenrisse, die nicht durchgehend sind und nicht die Konstruktion beeinflussen.
- Verdrehungen des Holzes, vorausgesetzt es lässt sich noch verarbeiten.
- An den nicht sichtbaren Seiten der Dachbretter können diese ungehobelt sein und es können Farbunterschiede vorkommen.
- Spätere Reklamationen durch unsachgemäße Montage oder absacken des Gartenhauses durch unsachgemäße Fundamente und Gründungen sind ausgeschlossen.
- Für Schäden, die durch falsche Pflege und unsachgemäßem oder fehlendem Anstrich resultieren (z.B. Verzug von Teilen), können keine Garantieansprüche erhoben werden.

Ansprüche auf Gewährleistungen beschränken sich auf den Austausch von fehlerhaftem Material. Alle weiteren Ansprüche sind ausgeschlossen

LACKIERUNG, WARTUNG UND ENTSORGUNG

Holz ist ein Naturprodukt und weist unterschiedliche Merkmale aus, wie grobe und feine Maserungen, Farbschattierungen und Veränderungen sowie Verwachsungen haben ihren Ursprung im Wuchs des Baumes. Sie sind bei Hölzern, die in der freien Natur wachsen, normal und deshalb nicht als Fehler, sondern vielmehr als Eigentümlichkeit des Naturwerkstoffes Holz anzusehen.

Beim Anstrich benutzen sie hochwertiges Werkzeug und Farbe. Beachten Sie die Sicherheits- und Verarbeitungshinweise des Farbenherstellers. Streichen Sie nie in direkter Sonne oder bei regnerischen Wetter. Lassen Sie sich ausführlich bei Ihrem Händler über den Holzschutz für Nadelhölzer beraten. Durch einen regelmässigen Anstrich beeinflussen Sie im wesentlichen die Lebensdauer ihres Produktes.

Pflegen Sie bewegliche Teile wie Schlösser, Scharniere und kontrollieren Sie diese regelmäßig auf funktions- fähigkeit. Um den ökologischen Kreislauf einzuhalten, bitten wir Sie, das Produkt am Ende der Lebensdauer fachgerecht in den jeweiligen Annahmestellen zu entsorgen. Die Auskünfte hierzu erhalten Sie in den Gemeinden vor Ort.

Das Unternehmen Alce s.r.l. behält sich vor, jederzeit und ohne Vorankündigung Änderungen an seinen Produkten vorzunehmen, um deren Qualität zu verbessern.

GÉNÉRALITÉS

Cher client,

Nous sommes heureux que votre choix se soit porté sur notre maisonnette!

Il est important de lire entièrement cette notice de montage avant de commencer la construction de votre maisonnette! Vous vous éviterez ainsi des problèmes et des pertes de temps inutiles.

Conseils:

- Avant son montage définitif, entreposez le kit de construction au sec et pas directement sur la terre, en le protégeant contre les intempéries (humidité, rayonnement du soleil, etc.). Ne pas conserver la merchandise dans un local chauffé!
- Au moment de choisir l'endroit de montage, veillez à ce que la maisonnette ne soit pas exposée à des conditions atmosphériques extrêmes (zones exposées à des vents forts).

Garantie

Votre maisonnette est réalisée en bois d'épicéa nordique de haute qualité et elle vous est livrée non traitée. Si elle devait donner lieu à des réclamations, malgré les soins apportés à notre contrôle en usine, nous vous demandons de remettre à votre revendeur spécialisé le bon de contrôle rempli et votre facture d'achat!

Ecarts qui ne constituent pas un motif de réclamation:

- Le bois est un produit naturel, ce qui fait que les réclamations reposant sur des phénomènes naturels ne tombent pas sous le coup de la garantie.
- Les réclamations concernant les matériaux ne sont pas acceptées si une peinture a déjà été appliquée!
- Noeuds qui sont inhérents au bois.
- Décolorations du bois qui n'exercent pas d'influences sur la durée de vie.
- Fissures / fentes de retrait qui ne sont pas traversantes et qui n'exercent pas d'influences sur la construction.
- Déformations du bois, sous réserve qu'il puisse encore être mis en oeuvre.
- Sur les faces non visibles des planches du toit et du plancher, il se peut que les planches ne soient pas rabotées, on peut observer des différences de couleur et des flaches.
- Une réclamation tardive résultant d'un montage incorrectement réalisé, d'un affaissement du maisonnette par suite de fondations et de soubassements incorrectement réalisés, est exclue.

Les recours en garantie se limitent au remplacement du matériel défectueux. Tous les autres recours sont exclus!

PEINTURE, ENTRETIEN ET ÉLIMINATION

Le bois est un produit naturel qui travaille de façon variable. Des caractéristiques telles que les madrures grossières et fines, les nuances de couleurs et les modifications, de même que les imbrications, ont leur origine dans la croissance du bois. Dans le cas de bois qui poussent en pleine nature, ces caractéristiques sont normales et ne doivent par conséquent pas être considérées comme des défauts mais, au contraire, comme une particularité de ce matériau naturel qu'est le bois.

Pour la peinture, n'utilisez qu'un outillage et une peinture de haute qualité, et respectez les consignes de sécurité et de mise en oeuvre du fabricant de peintures. Ne peignez jamais en plein soleil ou lorsque le temps est à la pluie. Faites-vous conseiller de façon détaillée par votre revendeur spécialisé quant à la protection à utiliser pour les conifères traités. En refaisant régulièrement la peinture, vous augmentez sensiblement la durée de vie de votre maisonnette. Nous vous conseillons également une inspection semestrielle de votre maisonnette.

Lubrifier les pièces mobiles telles que les serrures, charnières et chaînes avec une fréquence régulière, en veillant à ne pas enduire les parties environnantes.

À la fin de la vie du produit, procéder à la livraison du chalet directement à l'île écologique, dans la benne en bois. Ou, dans les municipalités où il est prévu, par la collecte des déchets encombrants.

L'entreprise Alce s.r.l. se réserve la possibilité d'apporter à tout moment et sans préavis des modifications à ses produits et d'en améliorer la qualité.

GENERAL GUIDELINES

Dear Customer,

thank you for choosing this Garden Shed. **It's important to read carefully the instructions before commencing the installation of the product**, thus avoid any problem and loss of time.

Tips:

- Store the kit in a dry place, not directly on the floor, and keep it protected from the elements (water, sun etc.) until final installation. Do not store the product in a heated room.
- When selecting the place where the shed will be located, please take care that it is not exposed to extreme weather conditions (such as to strong wind).

Warranty:

Your Garden Shed is made from high quality Nordic spruce and is delivered untreated. If arise complaints despite our thorough factory inspection, the compiled inspection certificate together with the purchase invoice must be presented to the dealer.

Exclusions:

- Wood is a natural material and, therefore, disputes relating to its natural behavior are not covered by the warranty.
- Complaints relating to the material will not be accepted once painted.
- Knots in the wood.
- Discolorations of wood that do not affect its duration.
- Cracks / non-through-cracks that do not affect the construction stability.
- Deformations of the timber, provided that it can still be worked.
- On the not visible sides of planks in the roof and floor, not planed parties are permitted; in the same parties they are also permitted different colors and chamfer.
- Subsequent claims due to non-conforming assembly or failure of the structure due to incorrect foundations will not be accepted.

Warranty claims are limited to the replacement of defective material, any other claim is excluded.

PAINTING, MAINTENANCE AND DISPOSAL

Wood is a natural product and moves in a variable way. Features such as large and subtle veins, nuances and color changes, and knots, are due to the growth of the tree. They are normal in the woods that grow outdoors and, therefore, should not be considered defects but rather natural wood characteristics.

For painting, please use quality tools and paints and respect the safety instructions and tips application of the paint manufacturer. Do not paint in direct sunlight or in case of rain and be advised in detail by the seller about treated softwoods protection. Having been properly painted substantially increase the duration of your Garden Shed. We recommend bi-annual inspection of the product.

Lubrify moving parts such as locks, hinges and chains with regular frequency, making sure not to smear the surrounding parts.

At the end of the life of the product, proceed to deliver the cottage directly to the ecological island, in the wooden dumpster. Or, in the municipalities where it is planned, through the collection of bulky waste.

The company Alce s.r.l. reserves the right to make changes to its products at any time and without notice and improve their quality.

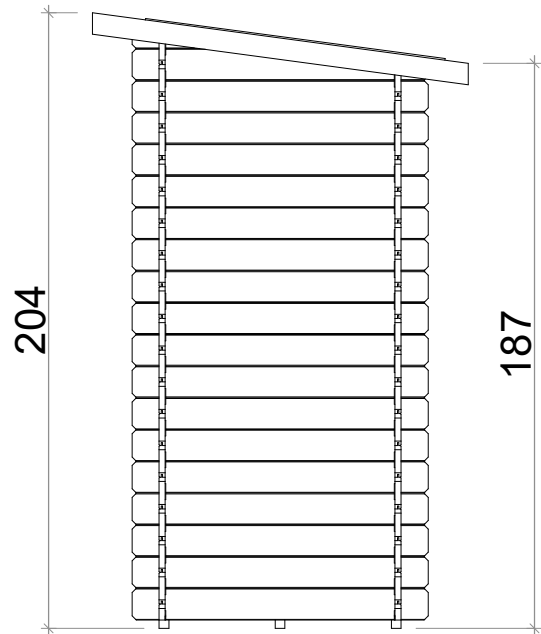
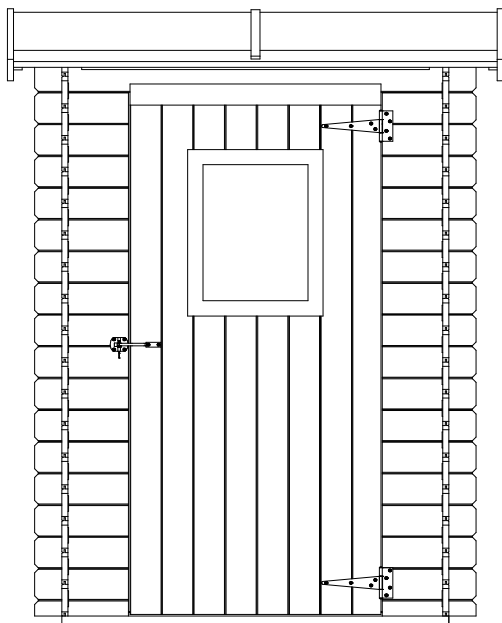
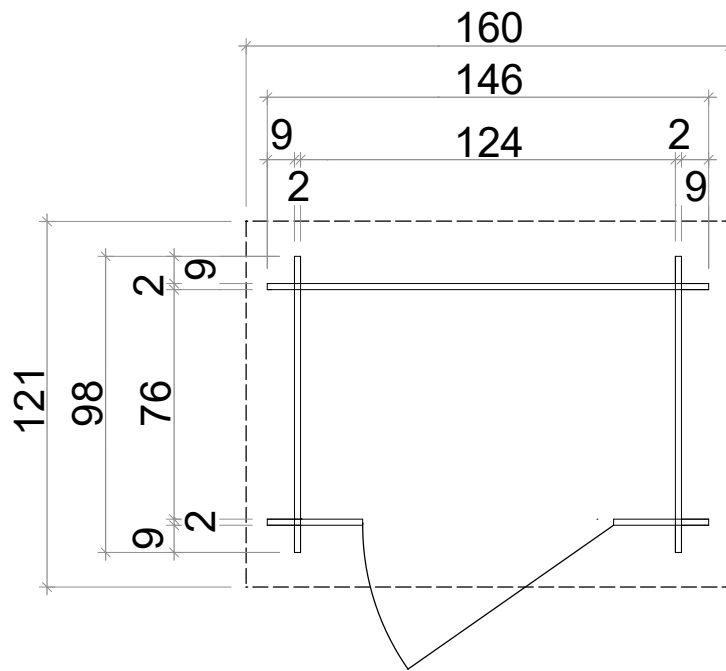

IT

AVVERTENZA: prima del montaggio scaricare la struttura e riporla in luogo livellato ed asciutto avendo cura di coprirla con il telo in dotazione all'imballo.

EN

WARNING: before assembly download the structure and store it in a dry and leveled place also take care to cover it with the tarp packaging supplied.

DE

HINWEIS: Bitte die Lieferung vor der Montage an einem trockenen und ebenen Ort akklimatisieren. Achten Sie darauf, dass die Palette mit einer Plane abgedeckt und vor Feuchtigkeit geschützt ist.

FR

AVERTISSEMENT: avant l'assemblage de la structure télécharger et stocker dans un endroit sec et nivelé en veillant également à le couvrir avec l'emballage fourni.

RESTAURIERUNGSKARTENCODE 62176ISTR HAUS BH19 Abmessungen:146x98 cm
KUNDE:



Überprüfen Sie die Artikel und senden uns den Fehlbestand zu. Bei qualitativen

Problemen, senden Sie uns bitte ein Foto zu, indem der Mangel deutlich ersichtlich ist.

QTA	DESCRIZIONE	DISEGNO	CODICE	CHECK
19	PERLINA 2X10,5X146 cm BLOCKHOUSE		78000B	
34	PERLINA 2X10,5X98 cm BLOCKHOUSE		78001B	
1	1/2 PERLINA 2X5,25X146 cm BLOCKHOUSE		78002B	
16	PERLINA FRONTE DX 2X10,5X31 cm BLOCKHOUSE		78003B	
16	PERLINA FRONTE SX 2X10,5X31 cm BLOCKHOUSE		78004B	
1	1/2 PERLINA FRONTE DX 2X5,25X31 cm BLOCKHOUSE		78005B	
1	1/2 PERLINA FRONTE SX 2X5,25X31 cm BLOCKHOUSE		78006B	
1	CUPOLINO DX HOBBY 62176/62177		79060	
1	CUPOLINO SX HOBBY 62176/62177		79061	
1	PORTA SINGOLA FINESTRATA PER CASSETTA HOBBY dim: 83X172 cm		81769	
1	FINESTRA VANIGLIA /PEFC		81917	
1	PLEXIGLASS DIM. 40,5X51 cm sp.2mm PER CASSETTA VANIGLIA		82537	
1	LISTELLO 1,2X7X83 cm COPRIPORTA		78100B	
1	LISTELLO 1,2X7X95 cm SEMBRANA		78101B	
2	LISTELLO 1,2X7X170 cm SEMBRANA		78102B	
1	PANNELLO OSB3 sp.12mm DIM. 76X124 cm PER CASSETTA HOBBY		79021	
2	PANNELLO OSB3 sp.12mm DIM. 80X122 cm PER CASSETTA HOBBY		79026	
3	LISTELLO 2,8X2,8X124 cm COPERTURA		78110B	
2	LISTELLO 2,8X2,8X99 cm COPERTURA		78111B	
2	LISTELLO 2,8X2,8X180 cm FISSAGGIO ANGOLI		78112B	
2	LISTELLO 2,8X2,8X190 cm FISSAGGIO ANGOLI		78113B	
2	LISTELLO 2X7X126 cm FASCIONE		78130B	
3	LISTELLO FONDAZIONE L = 128 cm PER CASSETTA BH20 IMPREGNATO		79040E	
3	LISTELLO FERMAGUAINA 1X3X90 IMPR. /PEFC		82001E	
1	GUAINA SINTOGLASS SENZA CIMOSA 100X750 CM ARDESIA GRIGIA		05592	
1	KIT FERRAMENTA PER CASSETTA		26241	
1	ISTRUZIONE PER CASSETTA		62176ISTR	

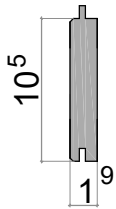

19x

A

146 cm



1x

B

146 cm



16x

C

31 cm

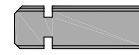

16x

D

31 cm



1x

E

31 cm



1x

F

31 cm



34x

G

98 cm



1x

H

56,2 cm



1x

I

56,2 cm



1x

J

98 cm



1x

K

98 cm



M

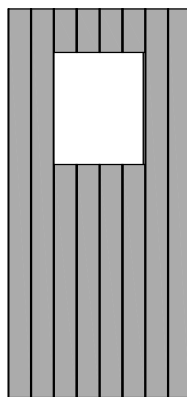

1x

cod.
82537



40,8x51 cm

1x

O



2x

122 cm

80 cm

P



1x

124 cm

76 cm

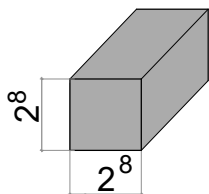

2x

Q

99 cm



3x

R

124 cm



2x

S

180 cm



2x

T

190 cm

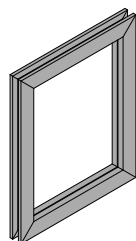

1x

cod.
81917

45x55 cm

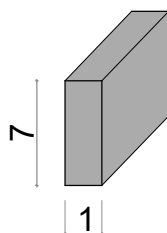

1x

W

83 cm



1x

X

95 cm



2x

Y

170 cm

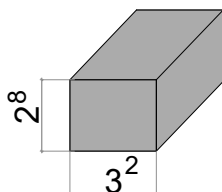

3x

Z

128 cm

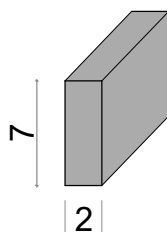

2x

AA

126 cm

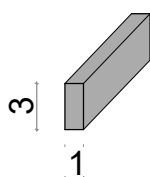

3x

cod.
82001B



~ 70 / 90 cm

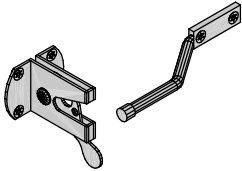

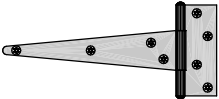



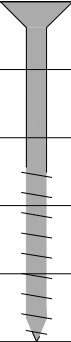
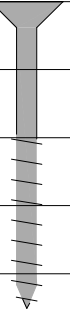
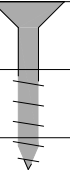
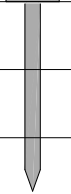





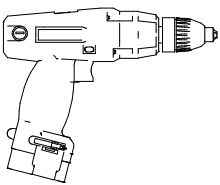

	1x	cod. 25590	
---	----	---------------	--

	2x	cod. 75132	
---	----	---------------	--

	1x	cod. 05586	330 cm
---	----	---------------	--------

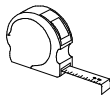
cod. 21050	cod. 21045	cod. 20027	cod. 20160	cod. 05579
Ø 4,5x50 mm	Ø 4x40 mm	Ø 4,5x20 mm	38 mm	13 mm
				
			0,5 kg	0,5 kg
25x	200x	100x	400x	430x

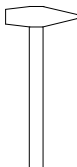
									
									
Ø 3 mm									

1

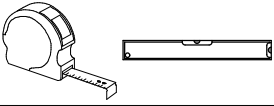

3x

Z

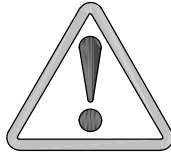

$d1=d2$

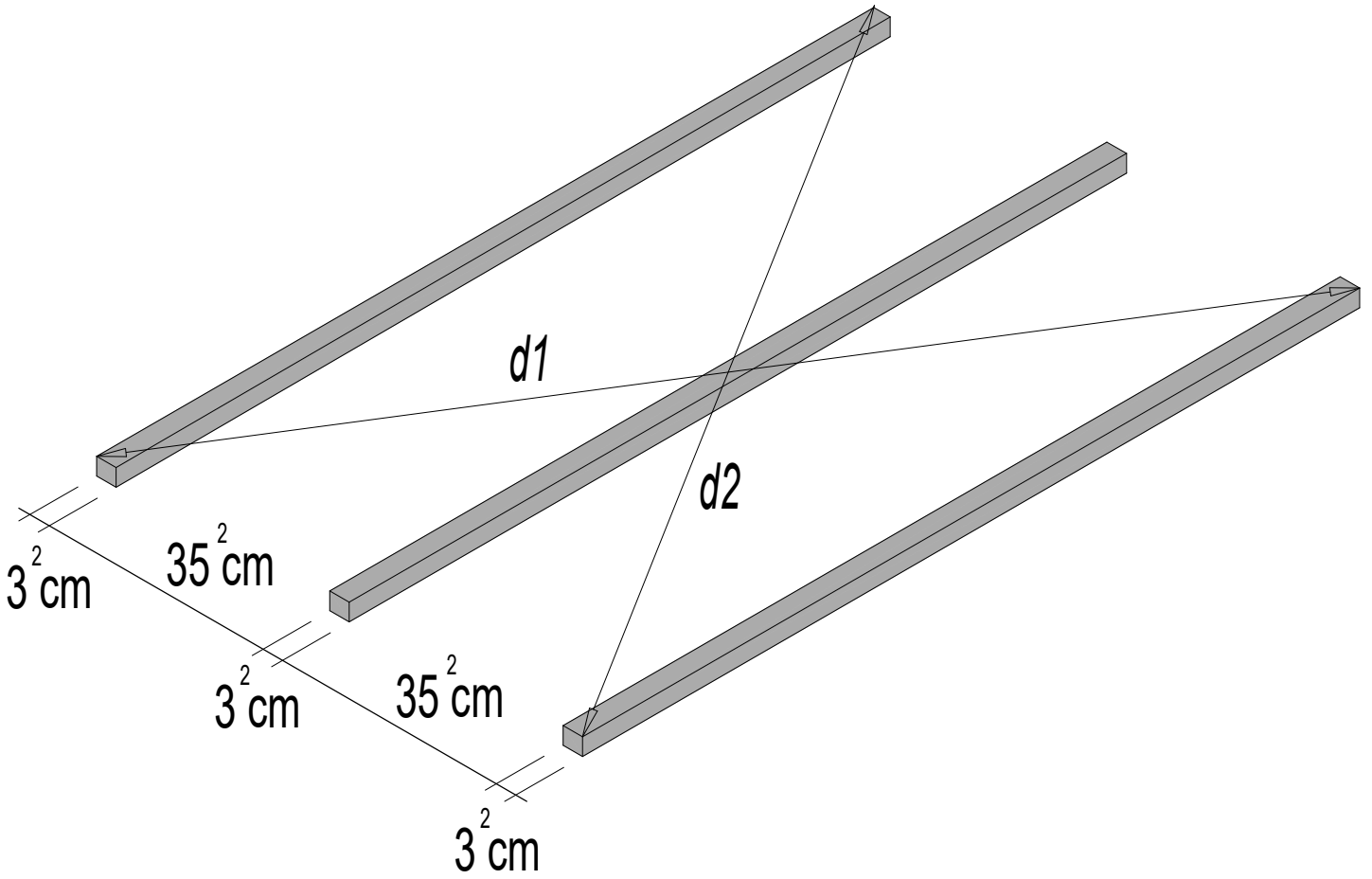

2

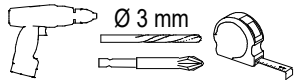

4x  cod. 21050

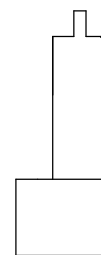
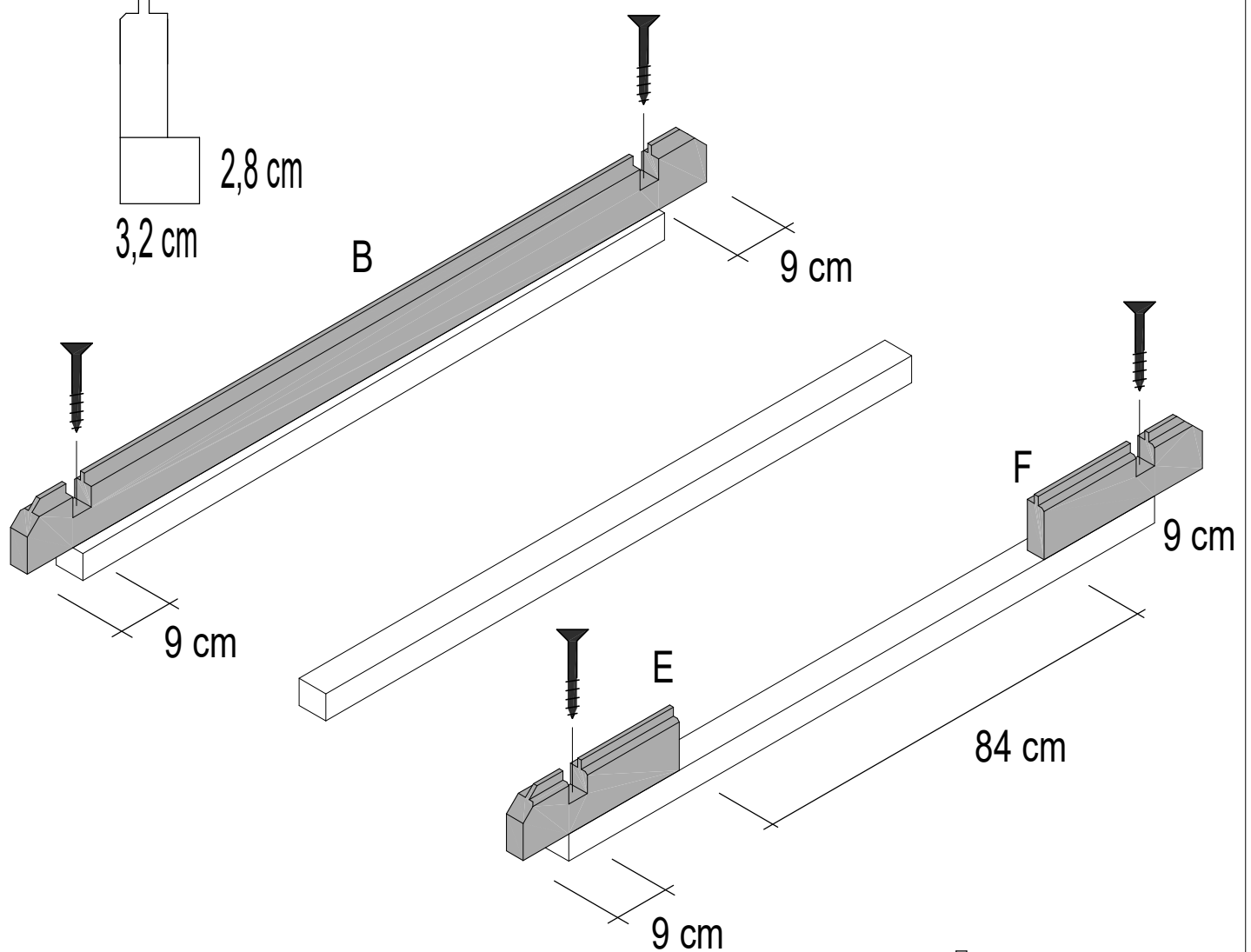
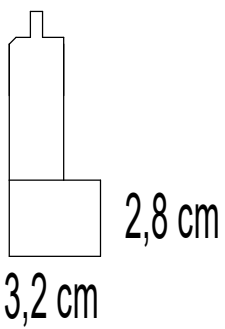
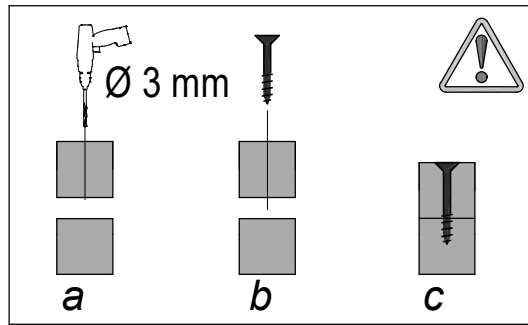
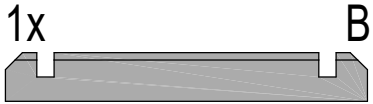
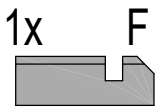
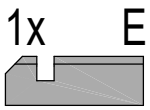

3

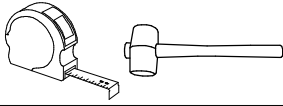

2x

G



$d1=d2$

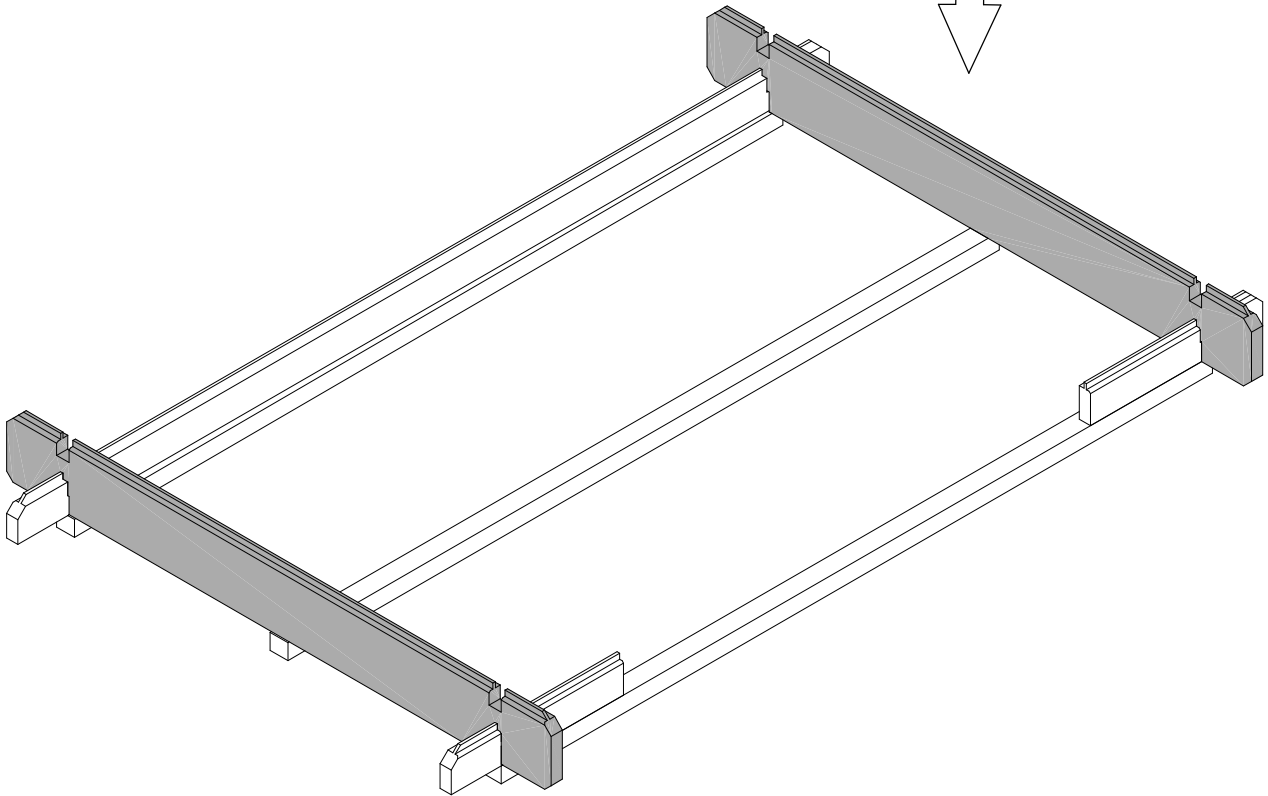
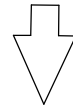
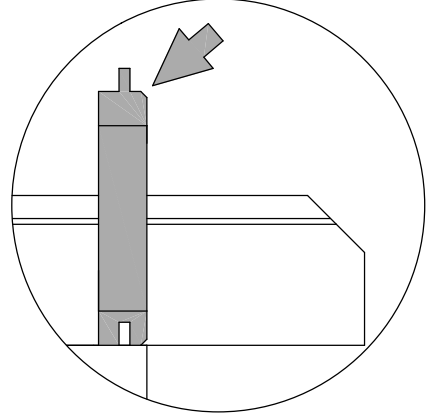
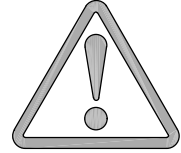
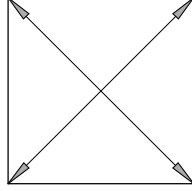

4

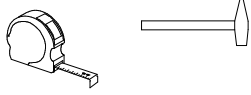

36x

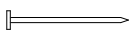

cod.
20160

1x

P

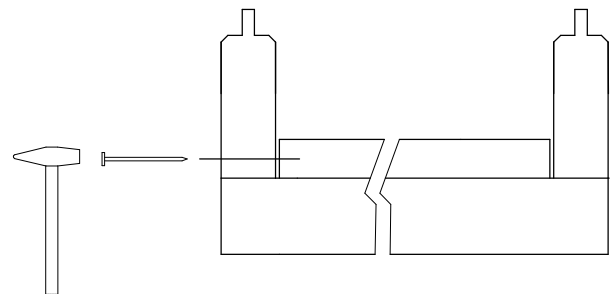
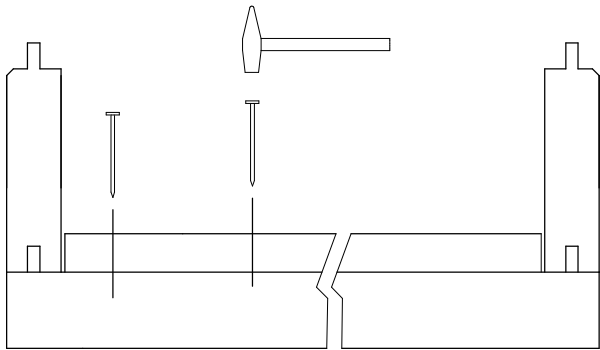
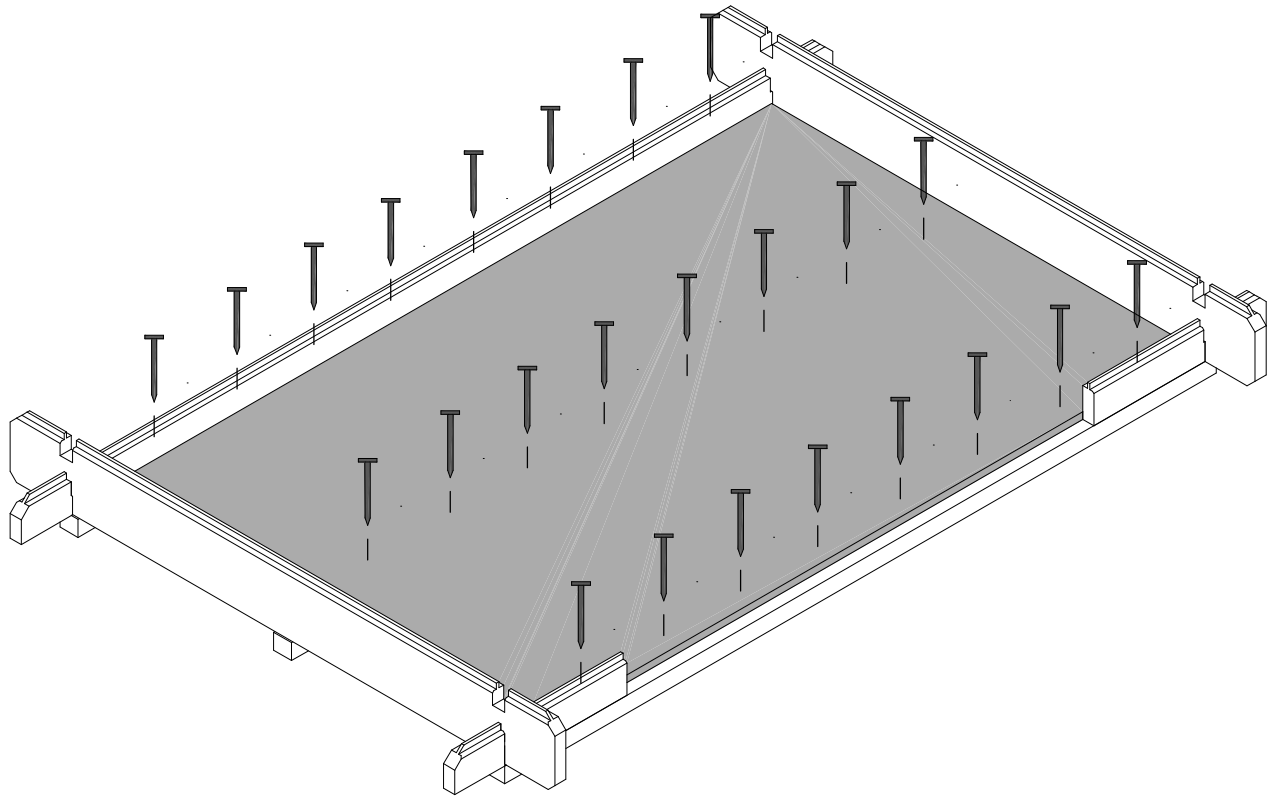
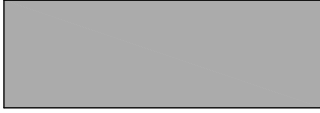

5

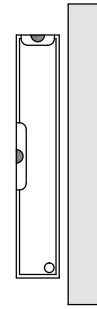
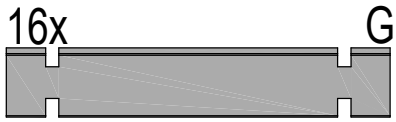
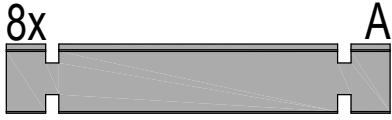
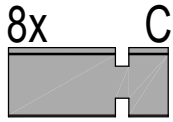
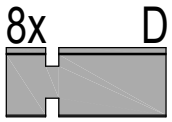
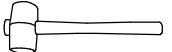

$d1=d2$

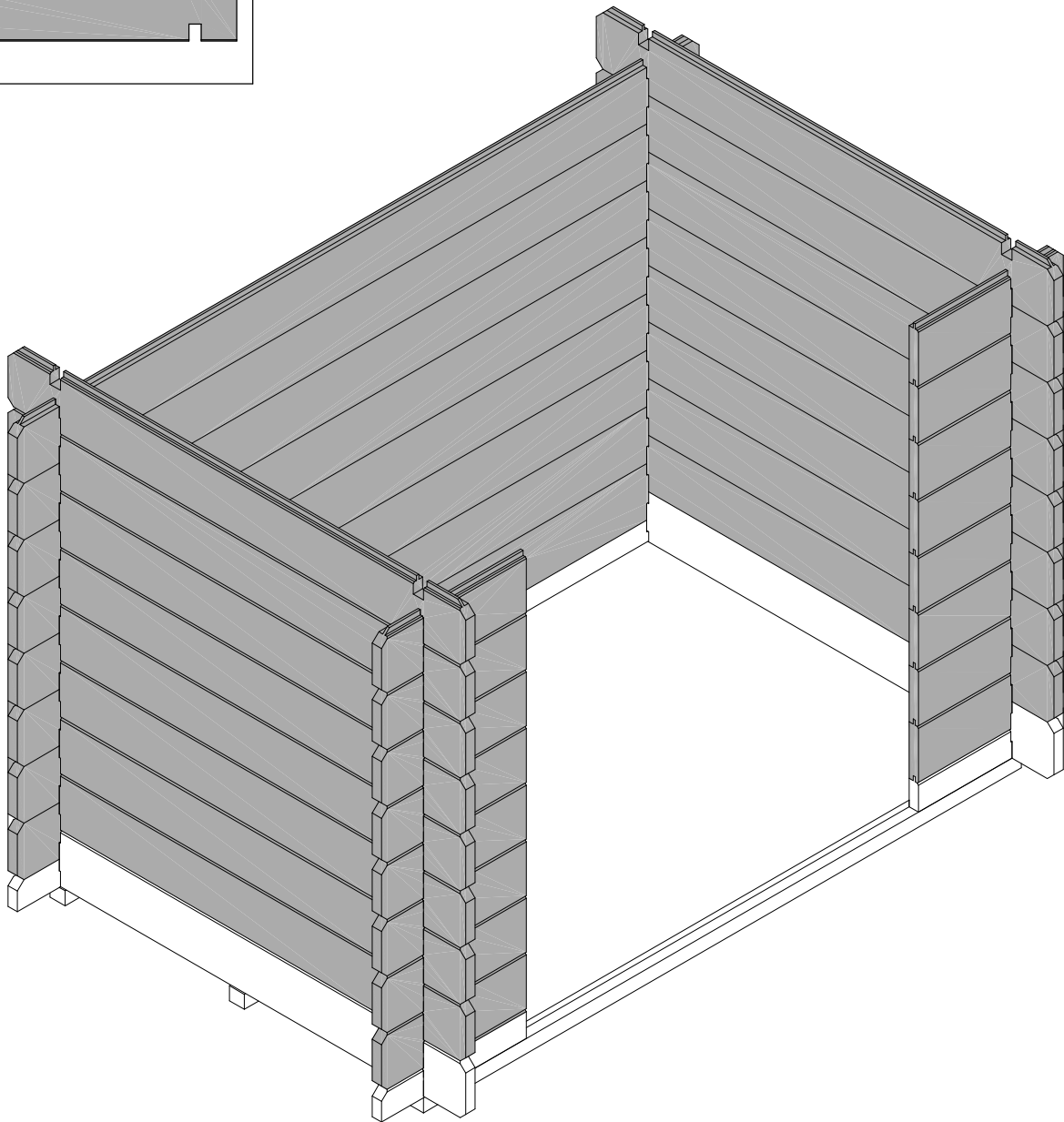
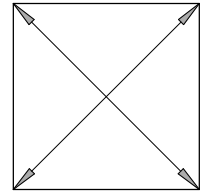

6

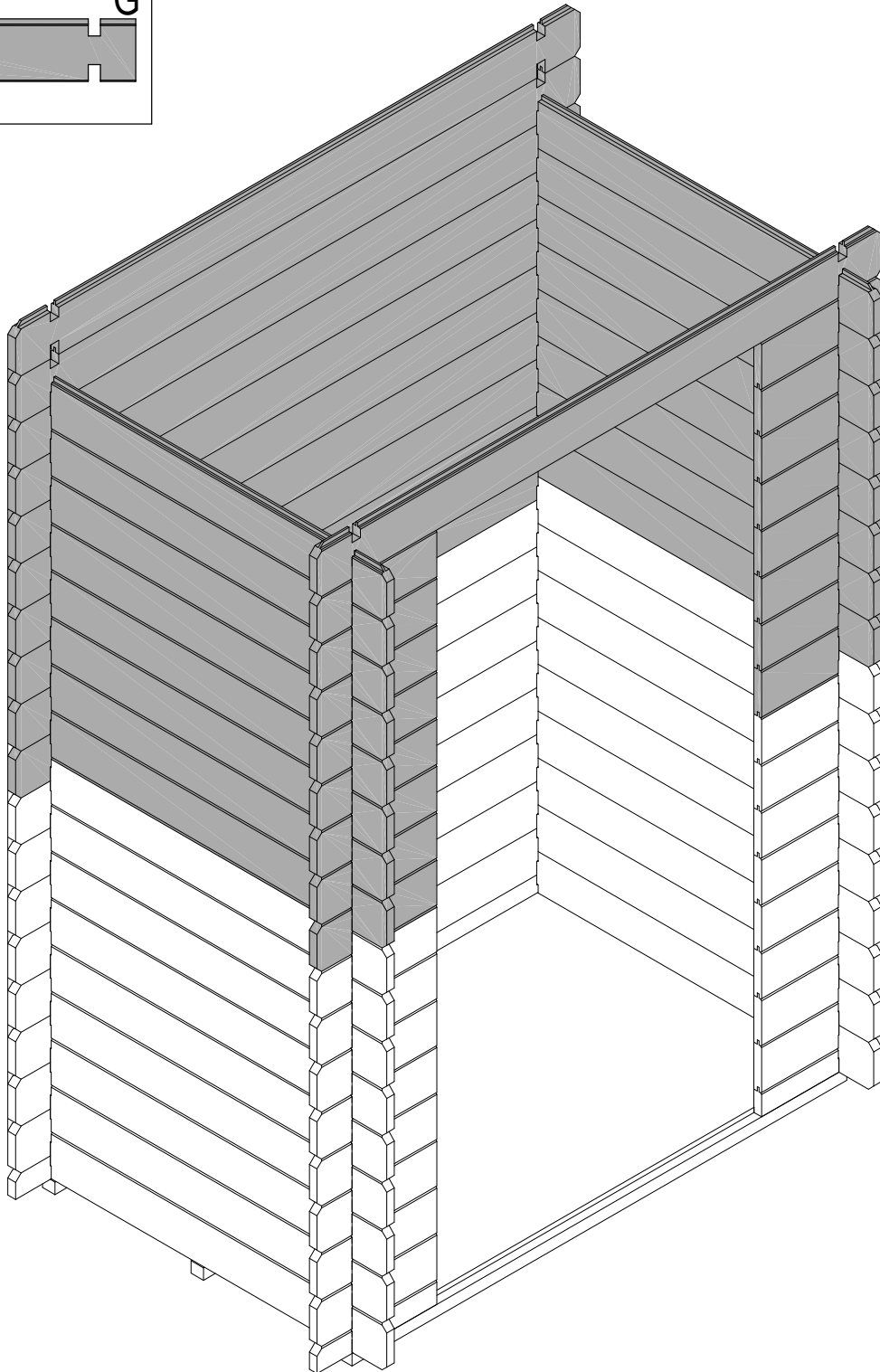
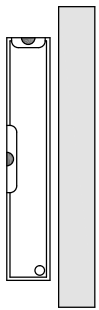
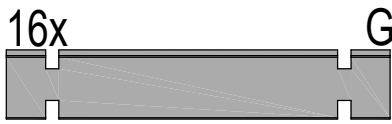
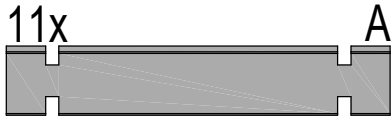
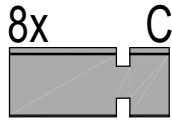
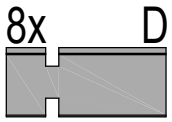

7

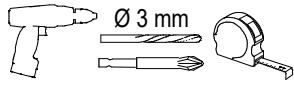

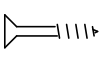
4x 

cod.
21050

1x  H

1x  I

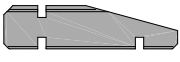
1x  K

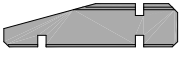
1x  J

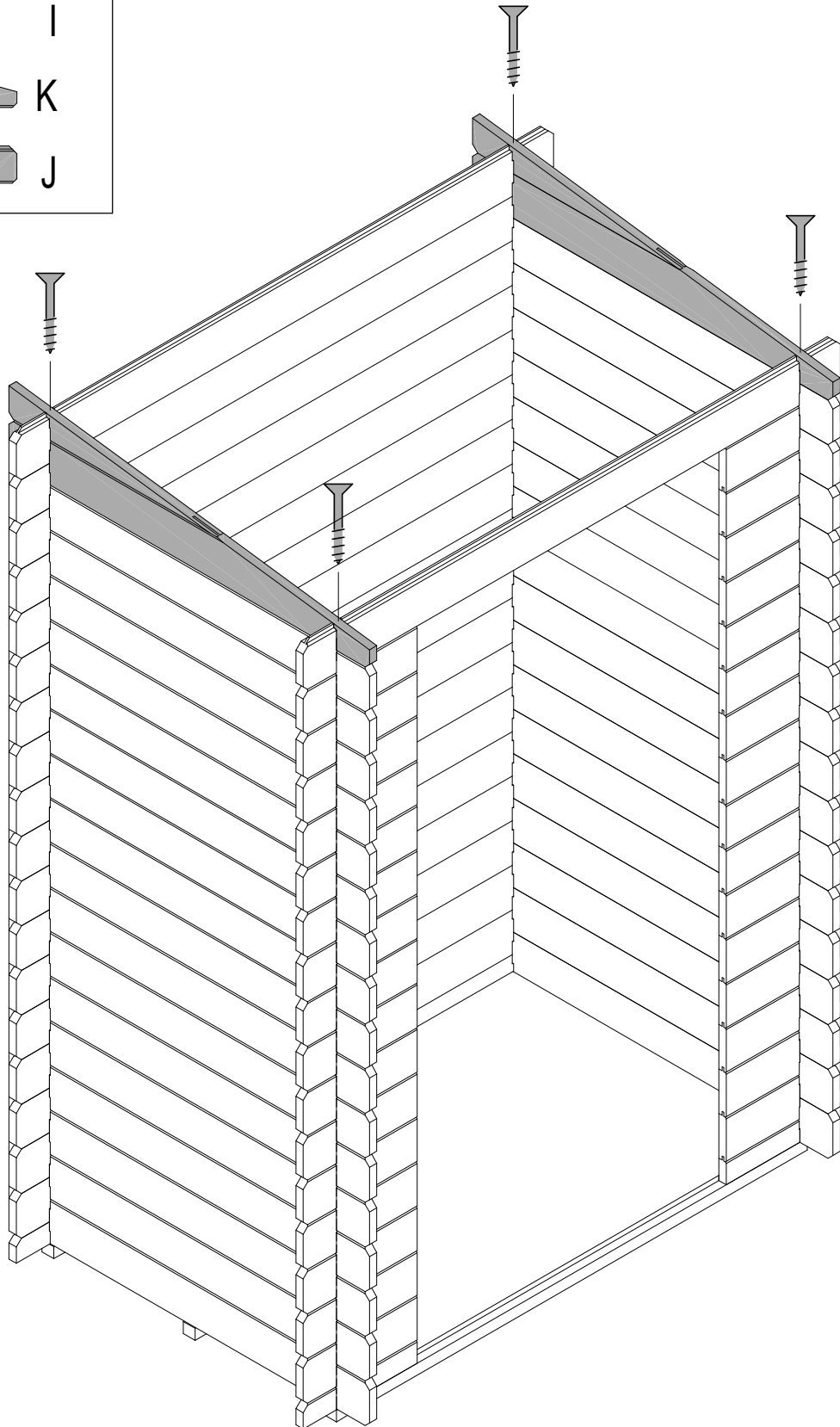

8

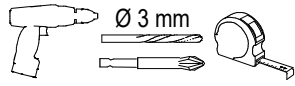

Ø 3 mm

10x

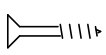

cod.
21045

3x

R

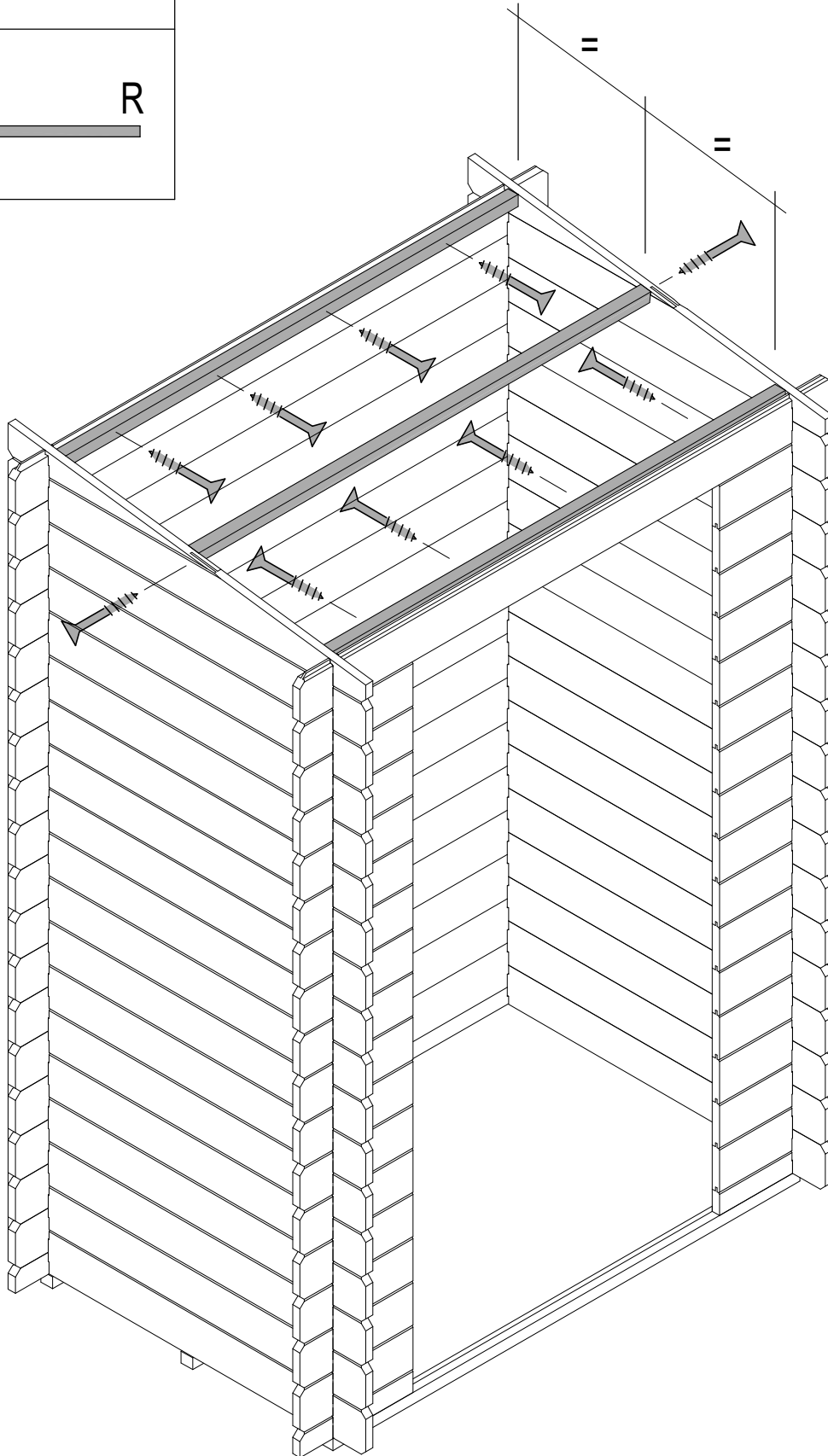

9

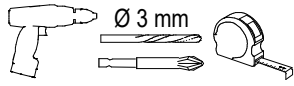

Ø 3 mm

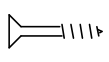
160x 

cod.
21045

2x

S



2x

T

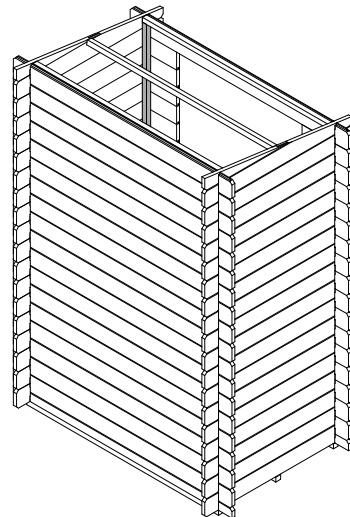
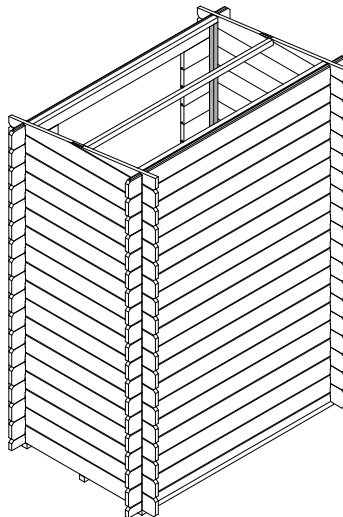
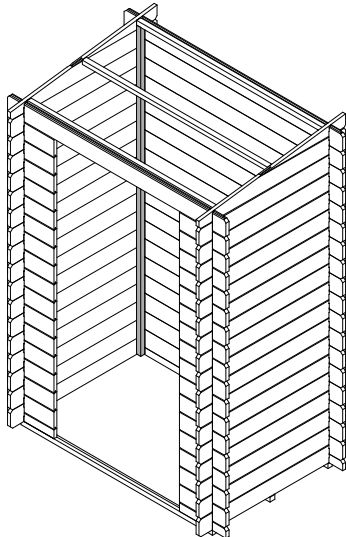
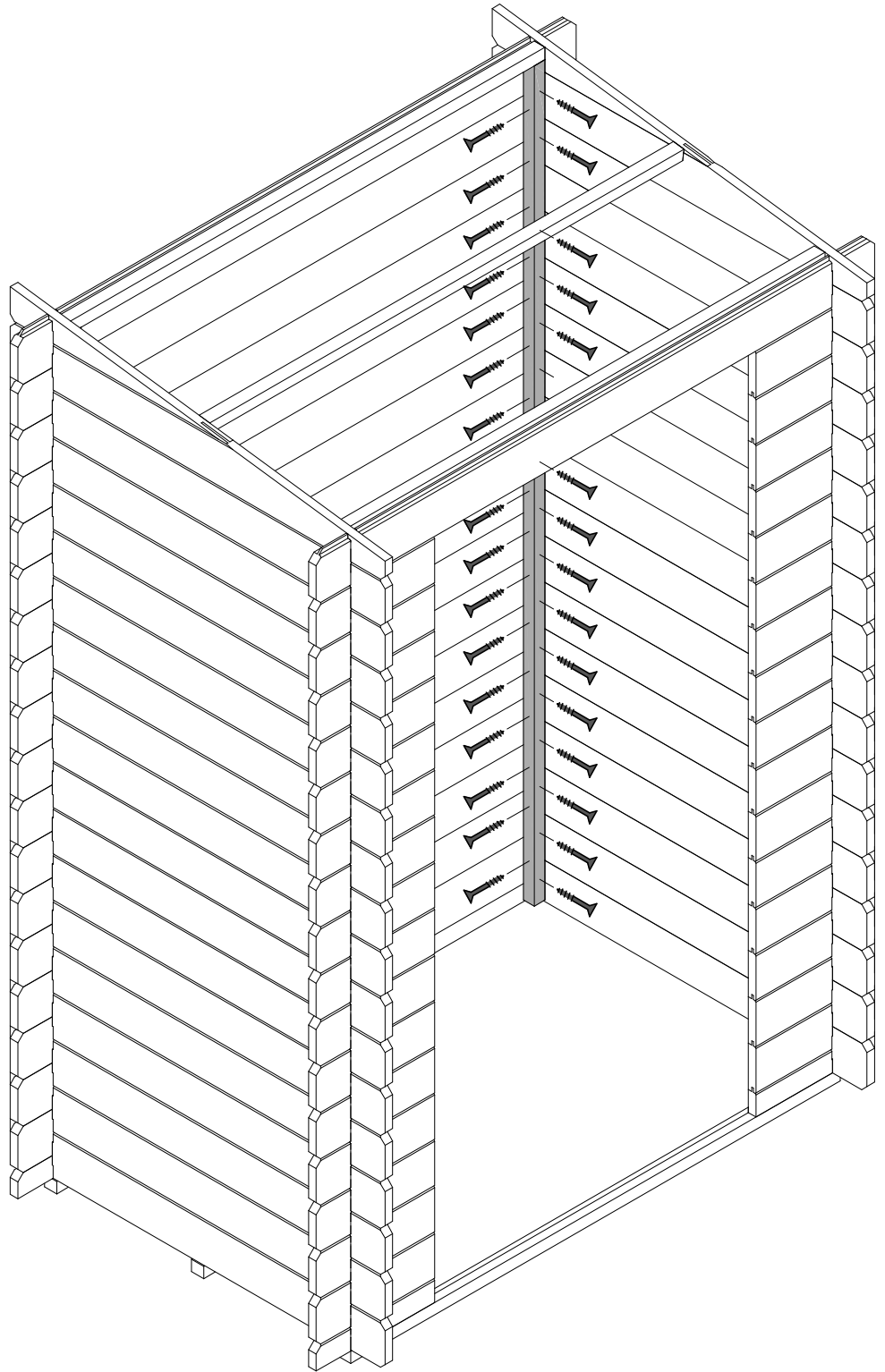

10

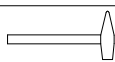

24x

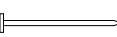

cod.
20160

1x

0

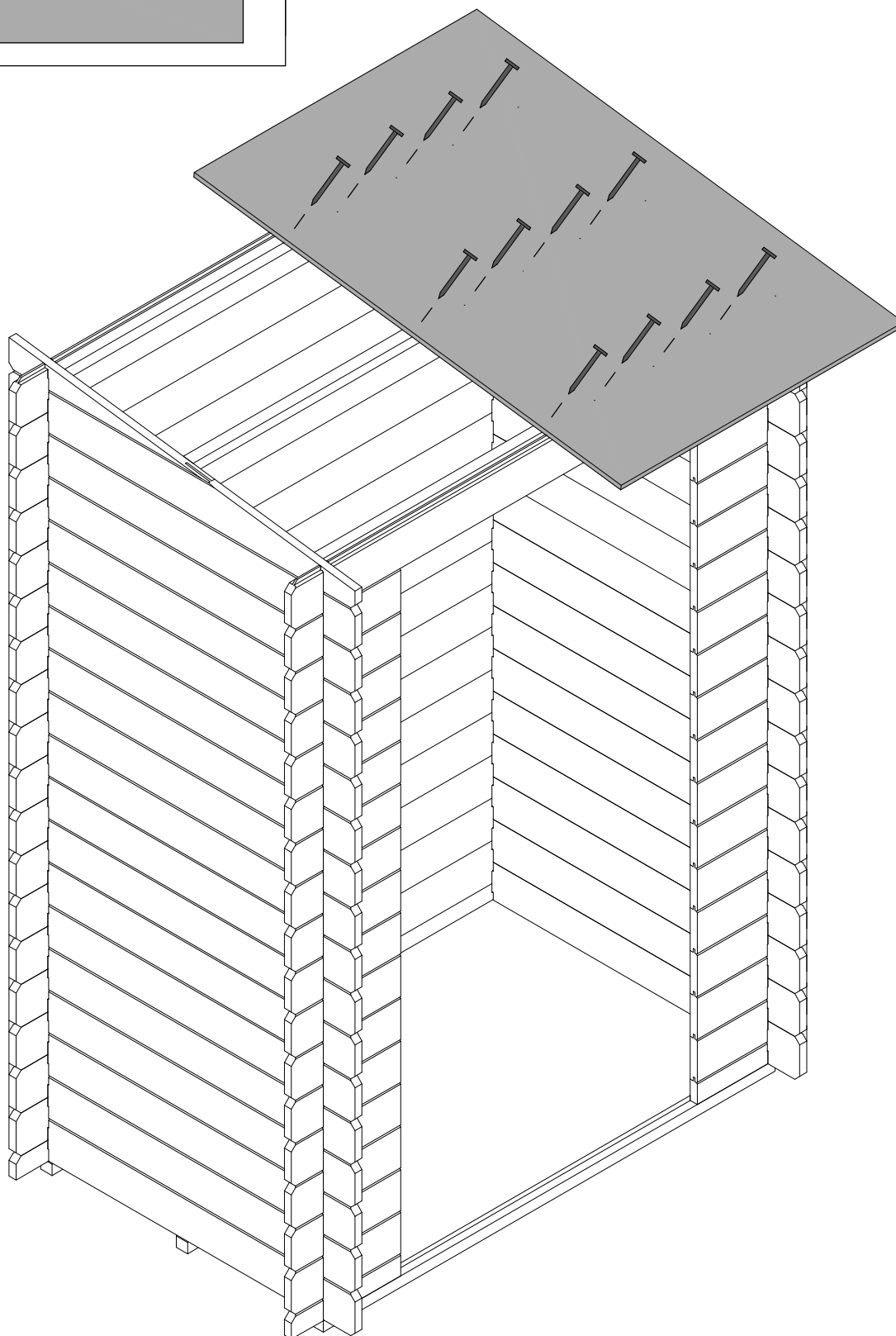
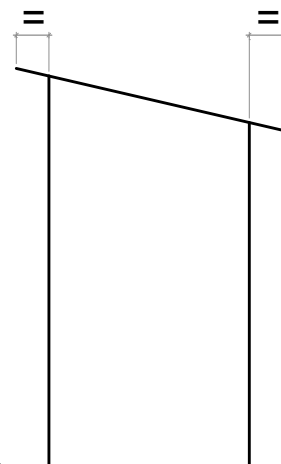
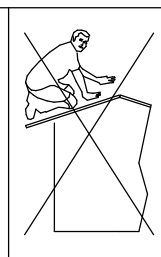

11

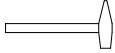
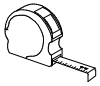

24x

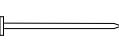

cod.
20160

1x

0

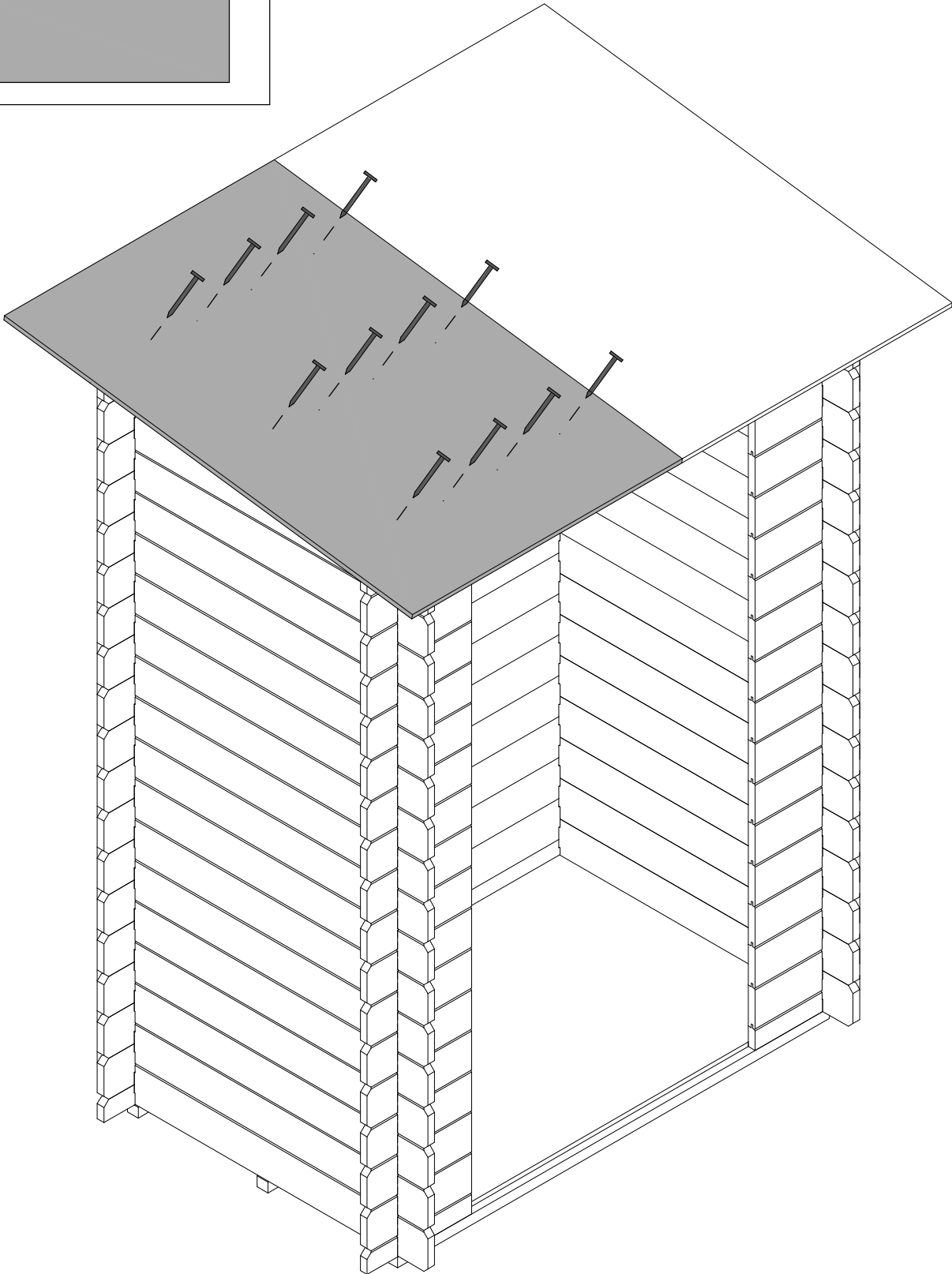
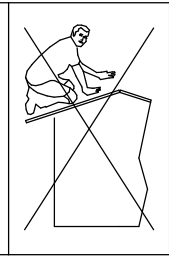

12

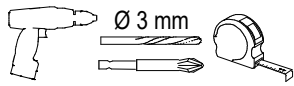

8x 

cod.
21045

2x

Q

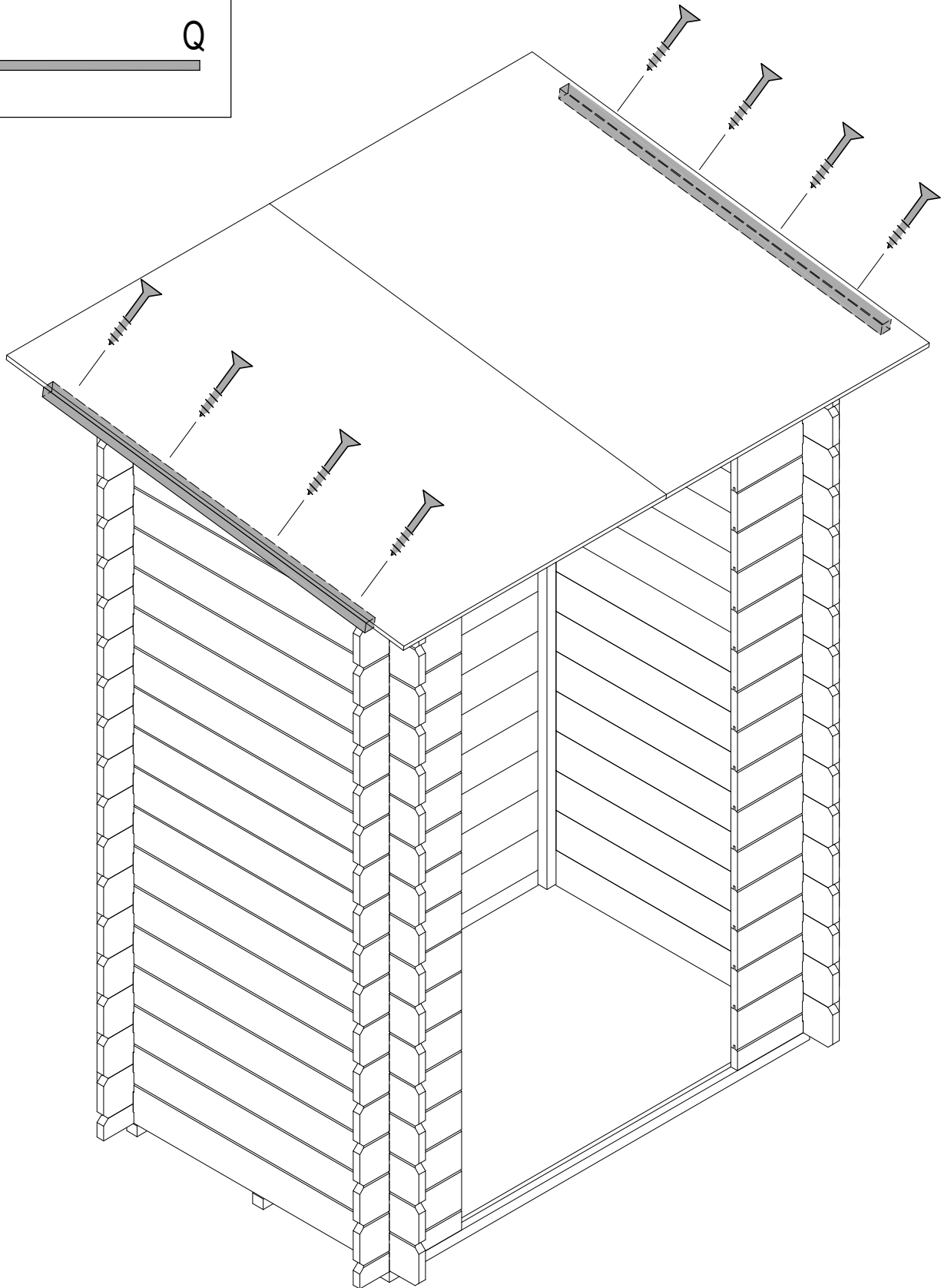

13

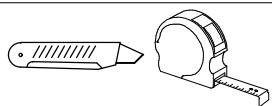

1x

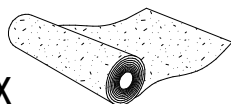

cod.
05586

1

165 cm

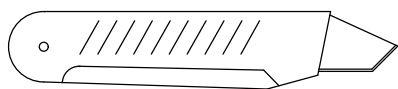

2

165 cm

100 cm

14

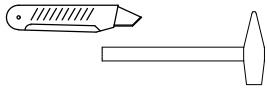

24x



cod.
05579

1x



cod.
05586

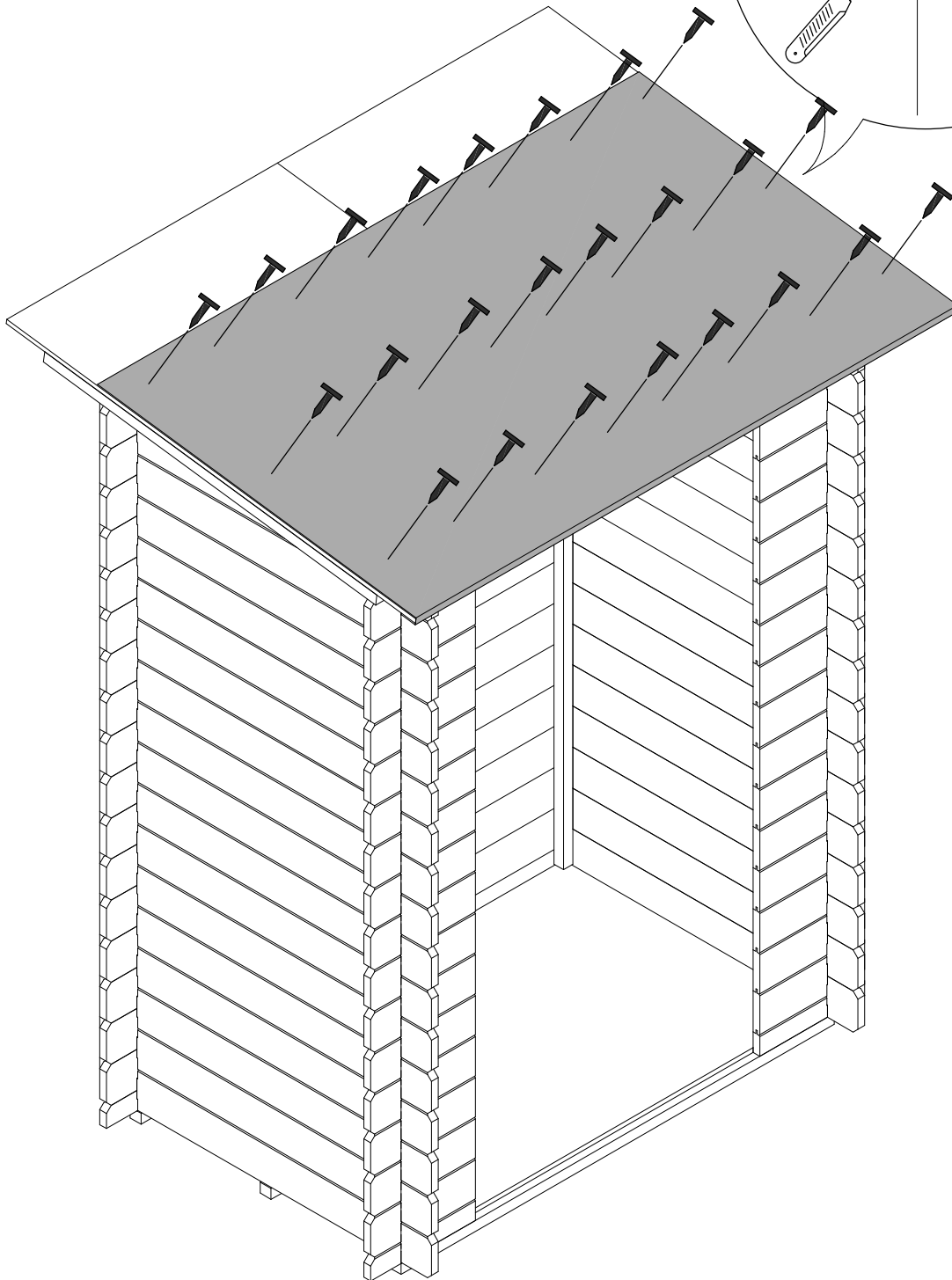
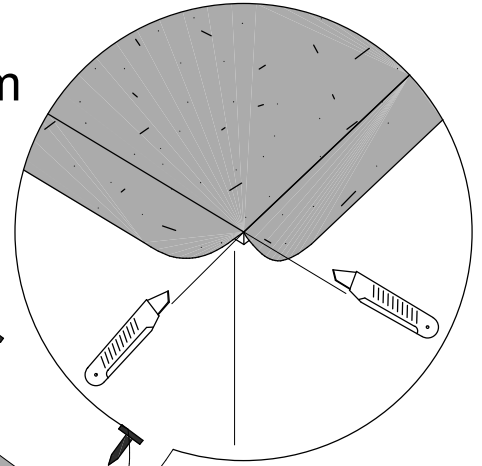
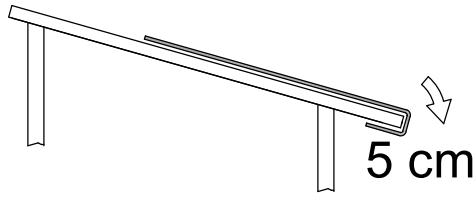
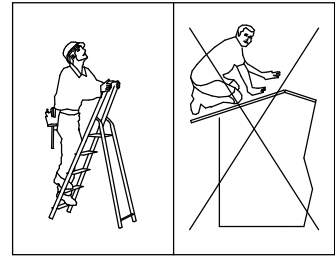

15

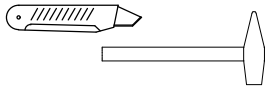

24x



cod.
05579

1x



cod.
05586

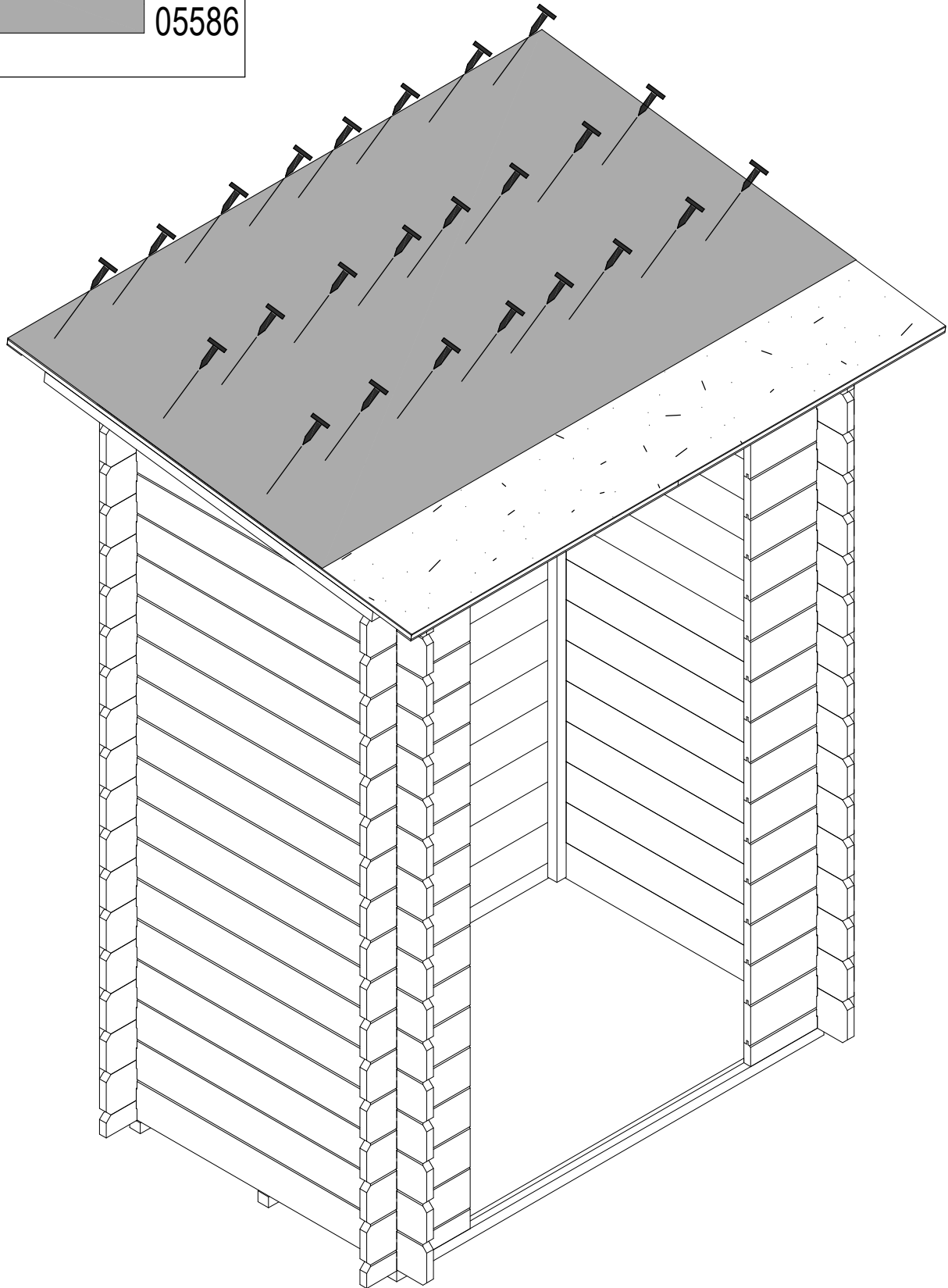
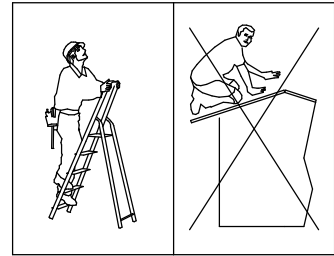

16

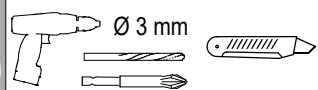

Ø 3 mm

6x



cod.
21045

2x



AA

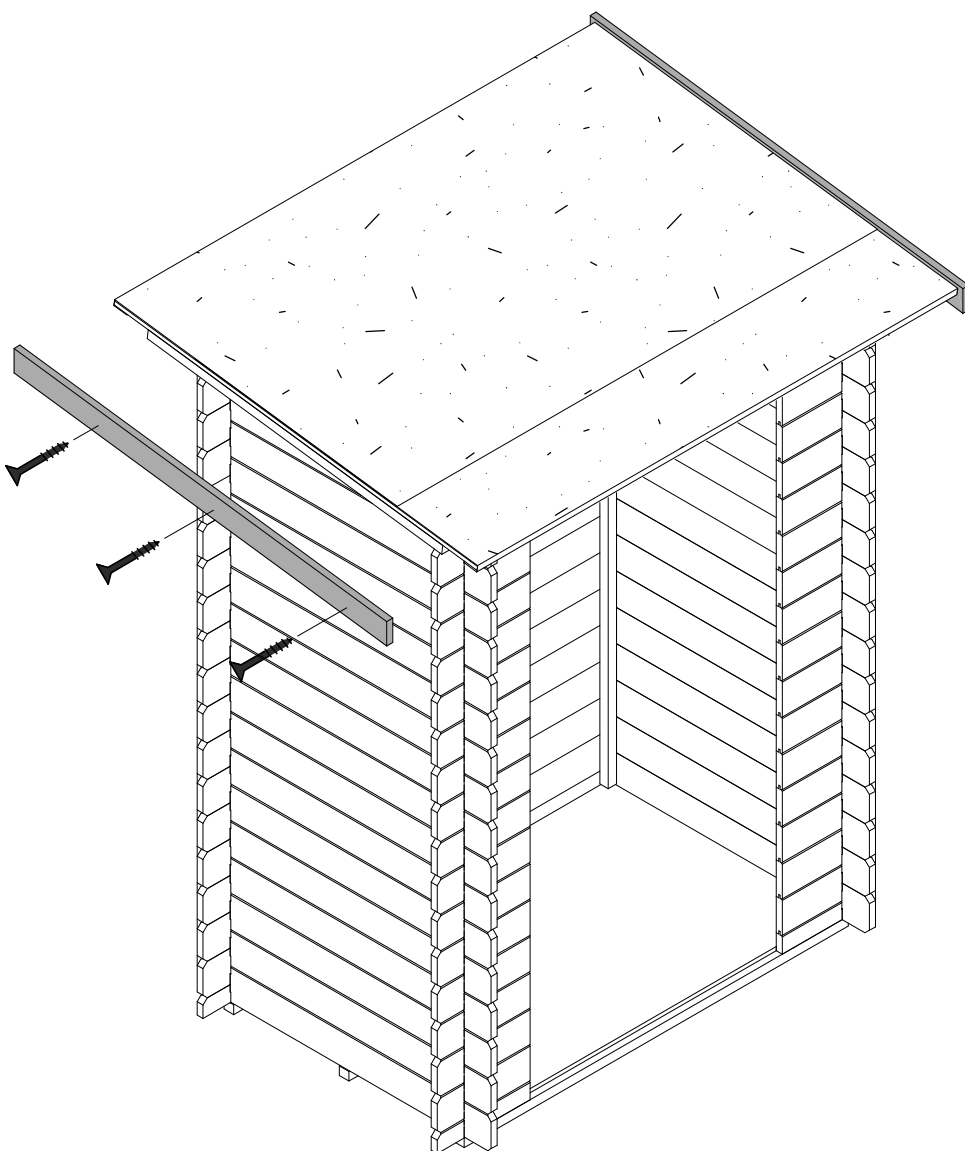
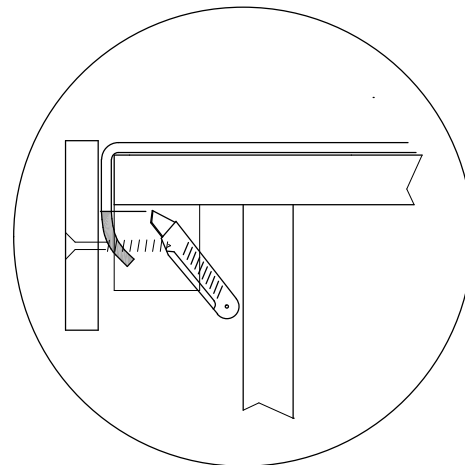
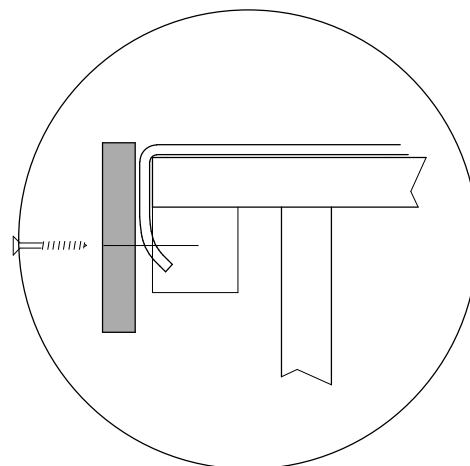
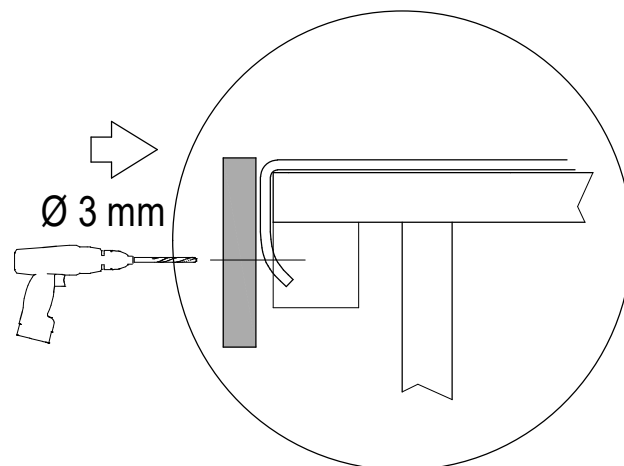
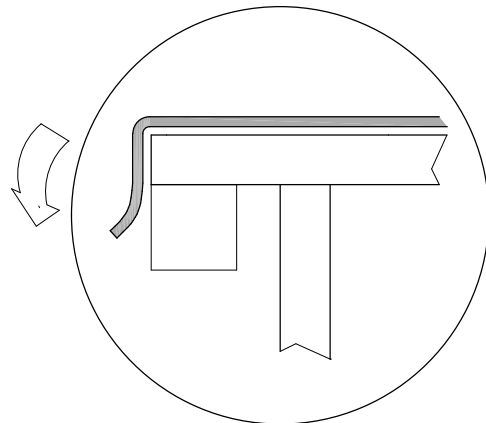

17

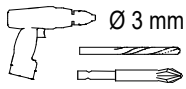

12x

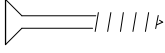

cod.
20027

3x



cod.
82001B

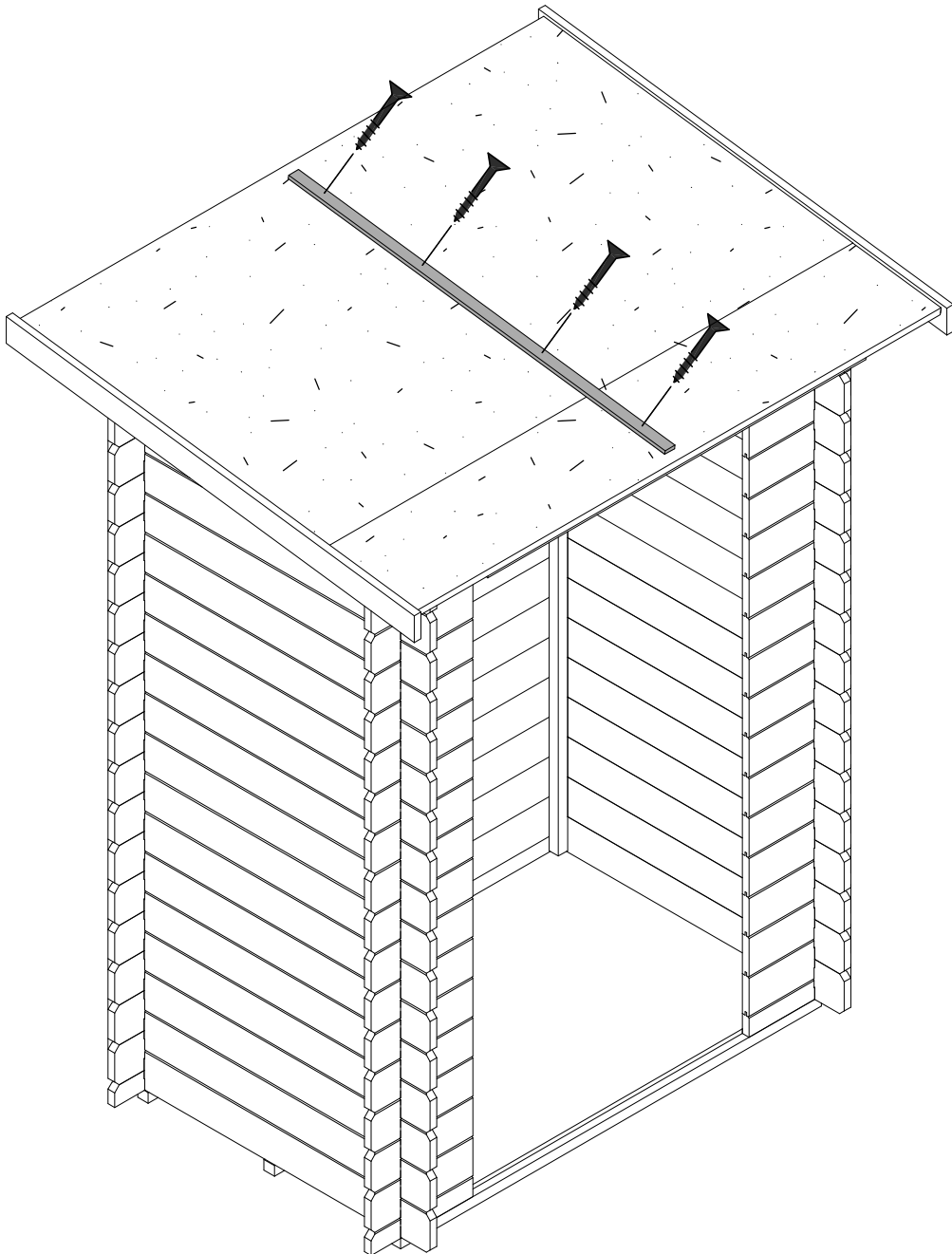
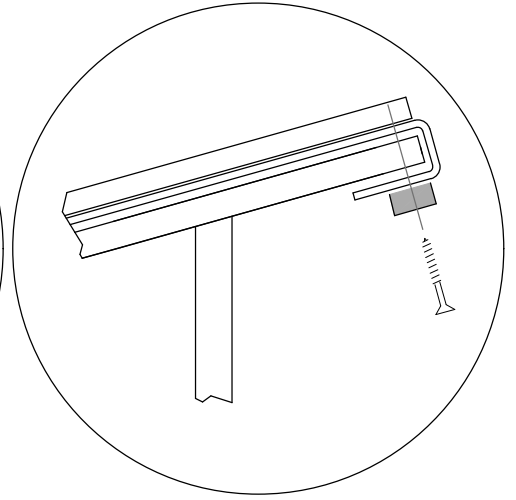
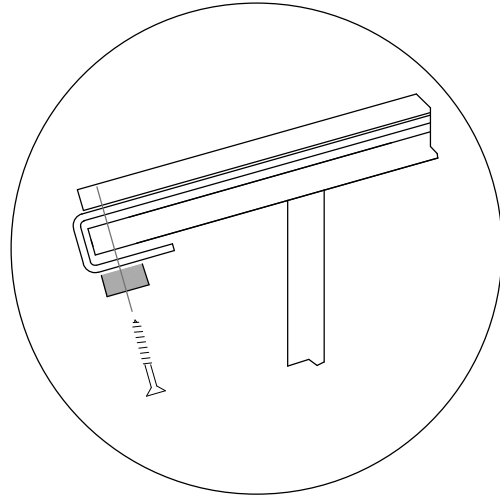

18

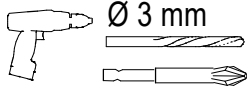

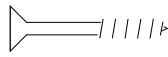
13x  cod. 20027

2x  Y

1x  X

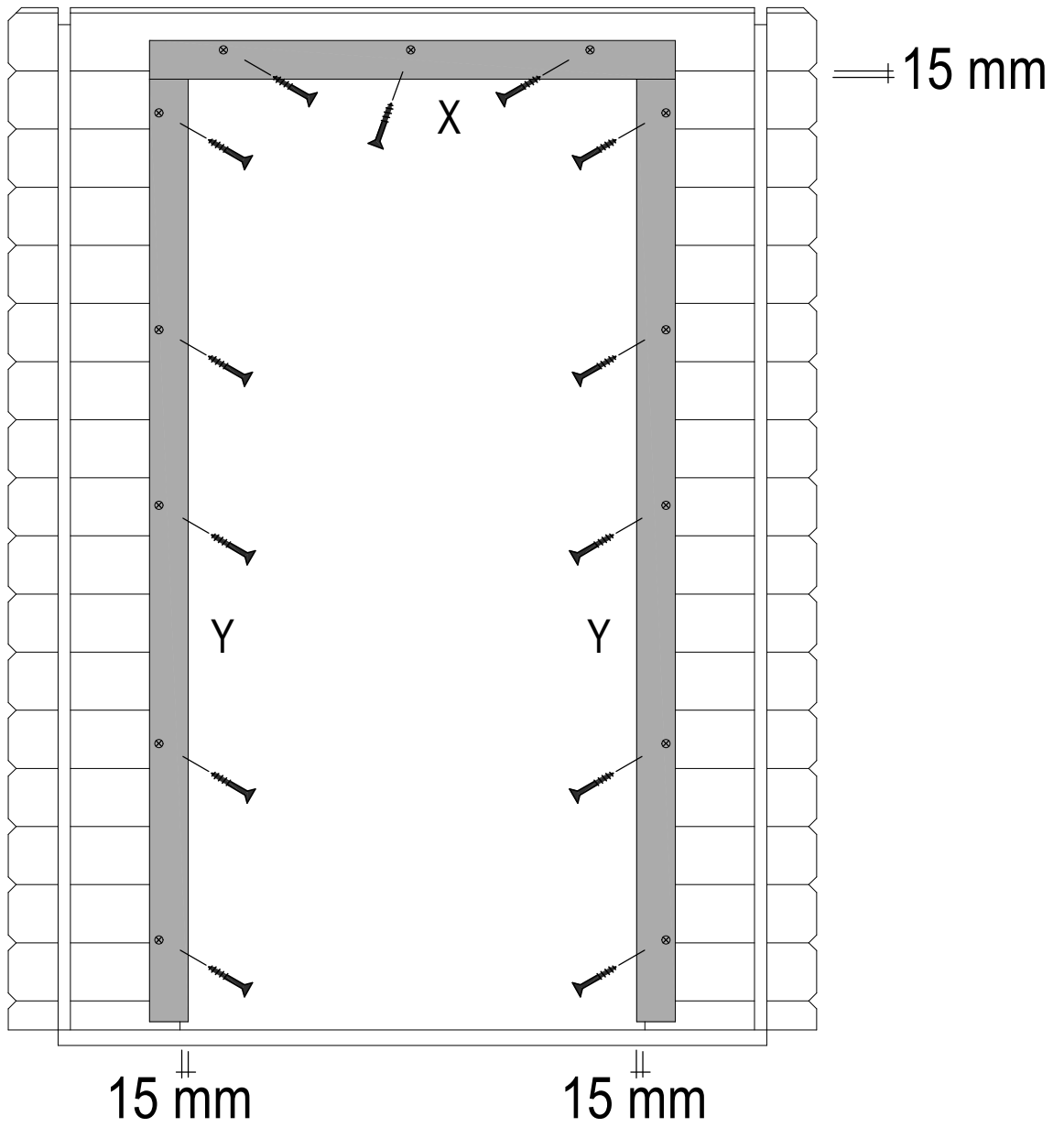
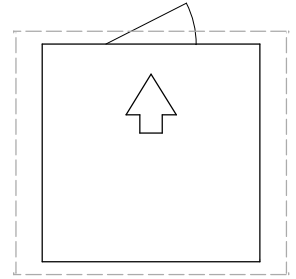

19

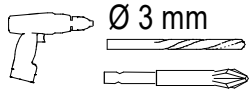

Ø 3 mm

1x



cod.
82537

1x

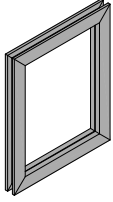

cod.
81917

1x

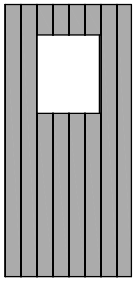

M

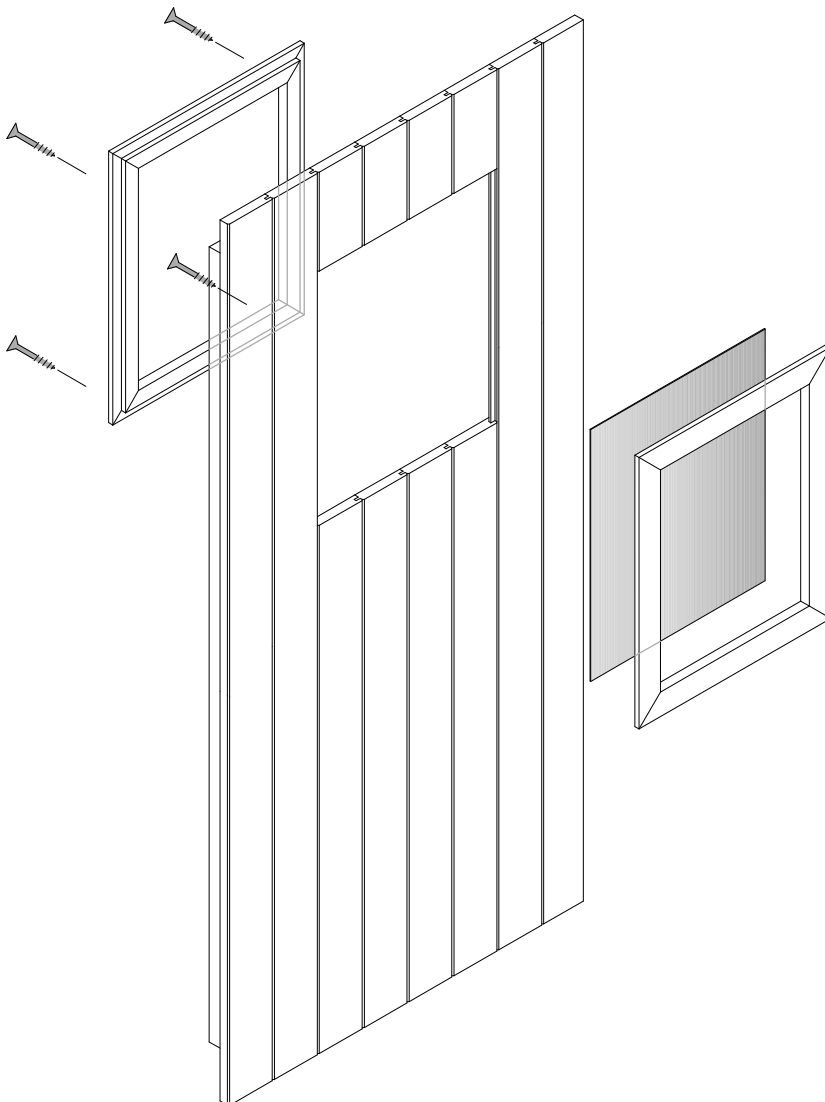
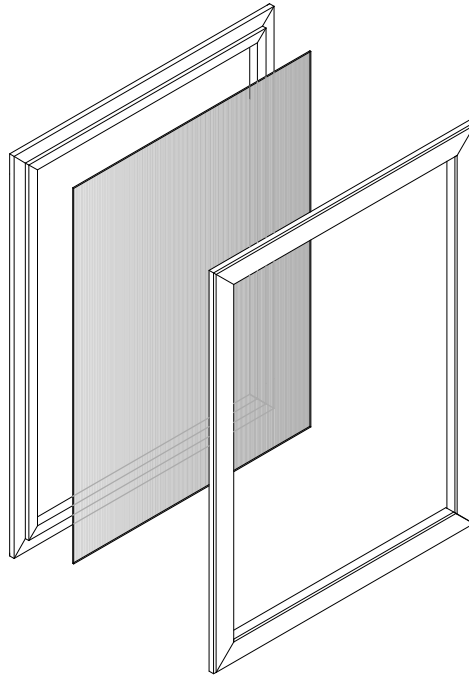

cod.
81917

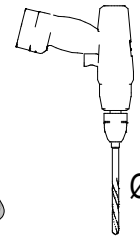
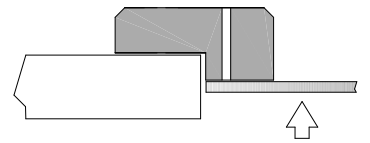
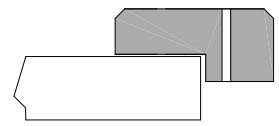
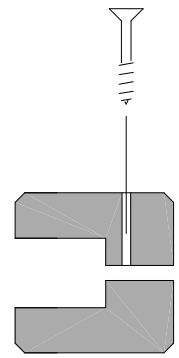
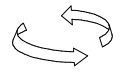

Ø 3 mm

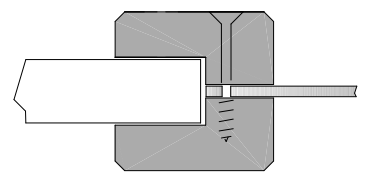
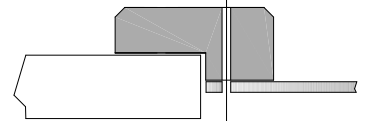

20

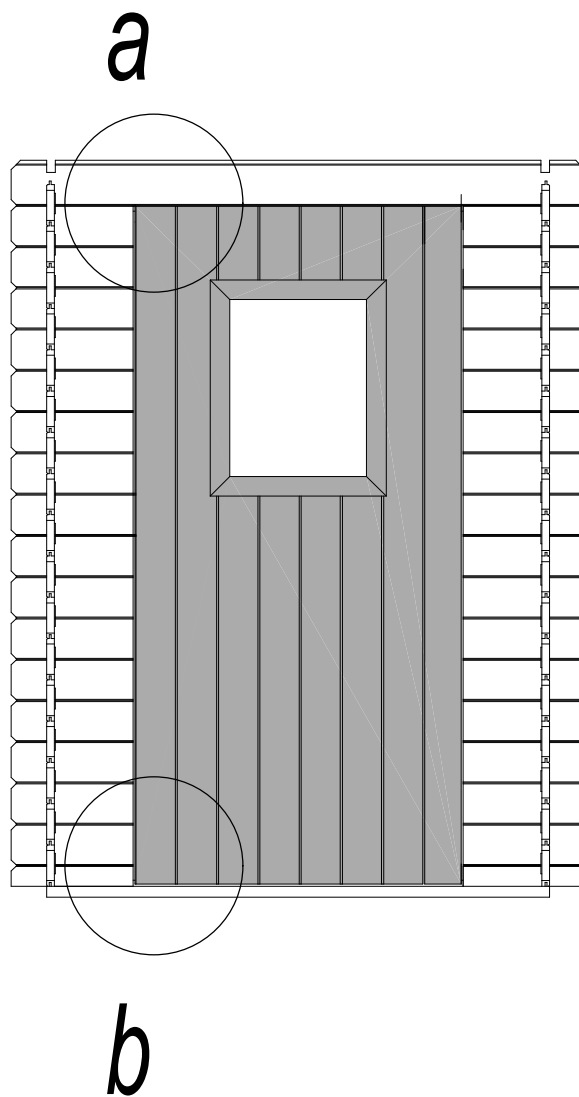
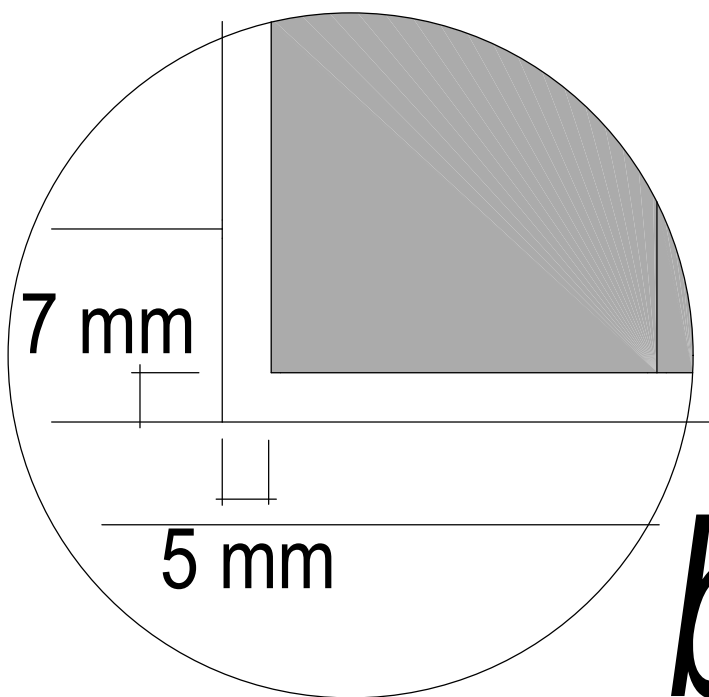
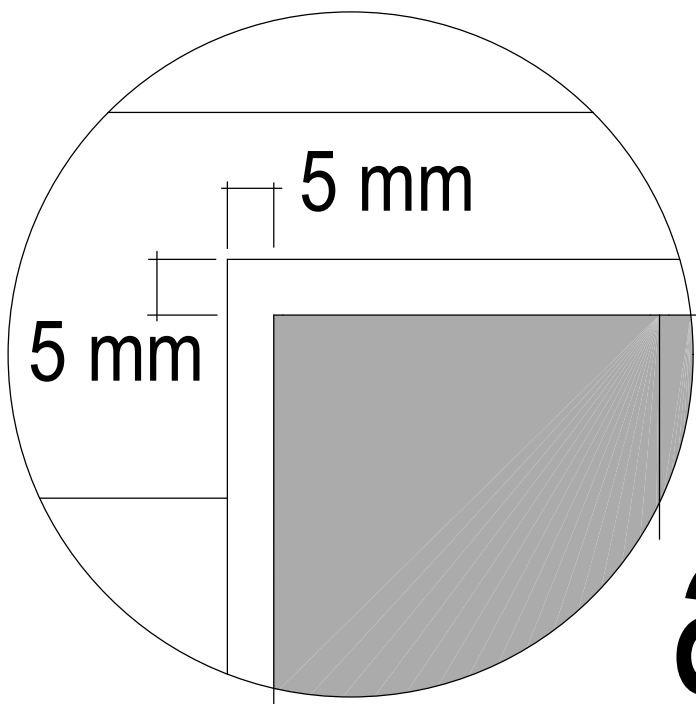
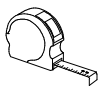

21

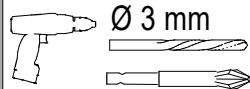

16x

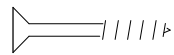

cod.
20027

2x

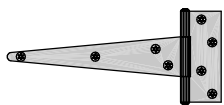

cod.
75132

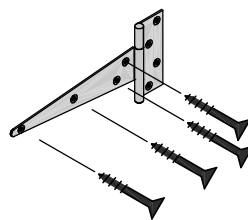
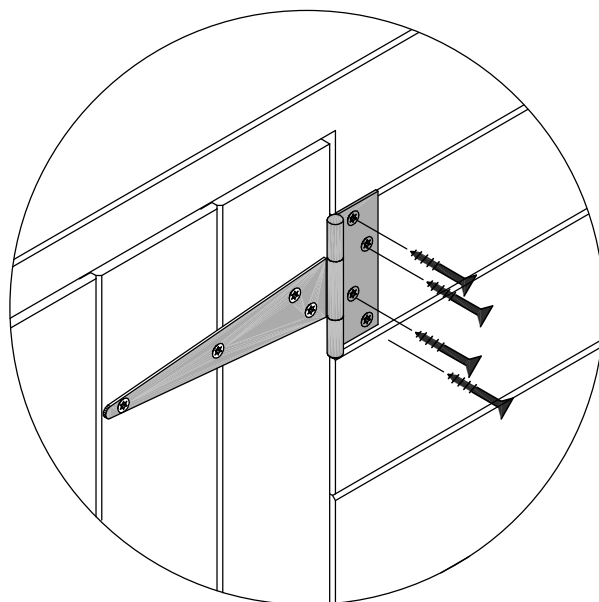
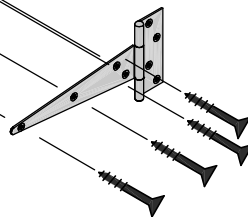
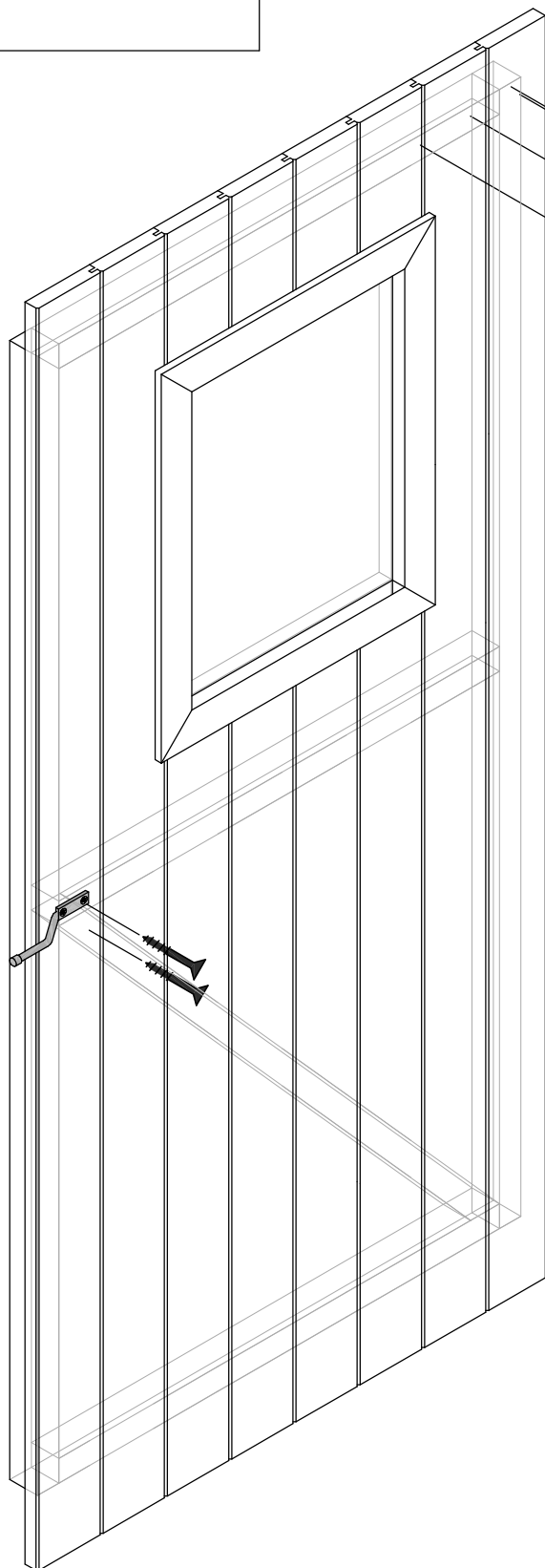
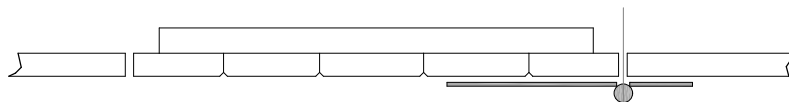

22

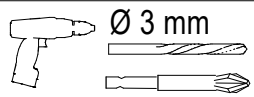

Ø 3 mm

4x

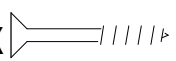

cod.
20027

1x

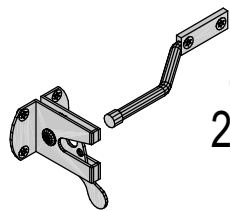

cod.
25590

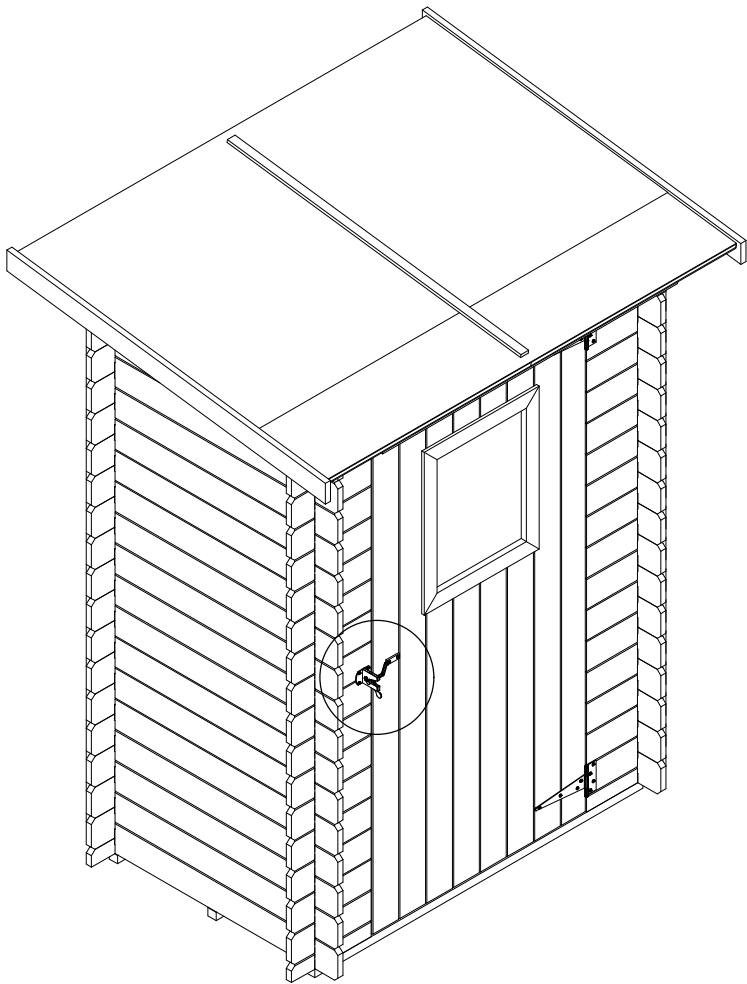
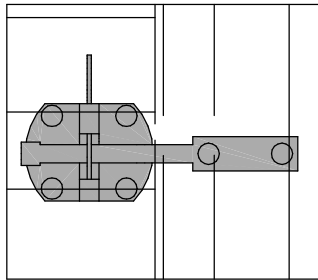
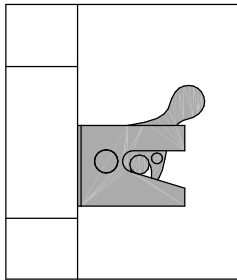
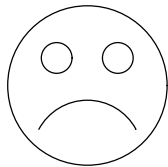
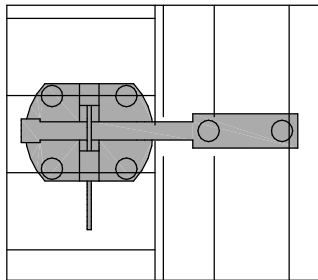
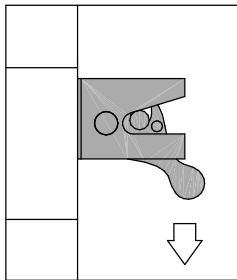
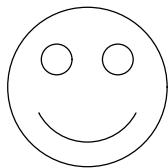
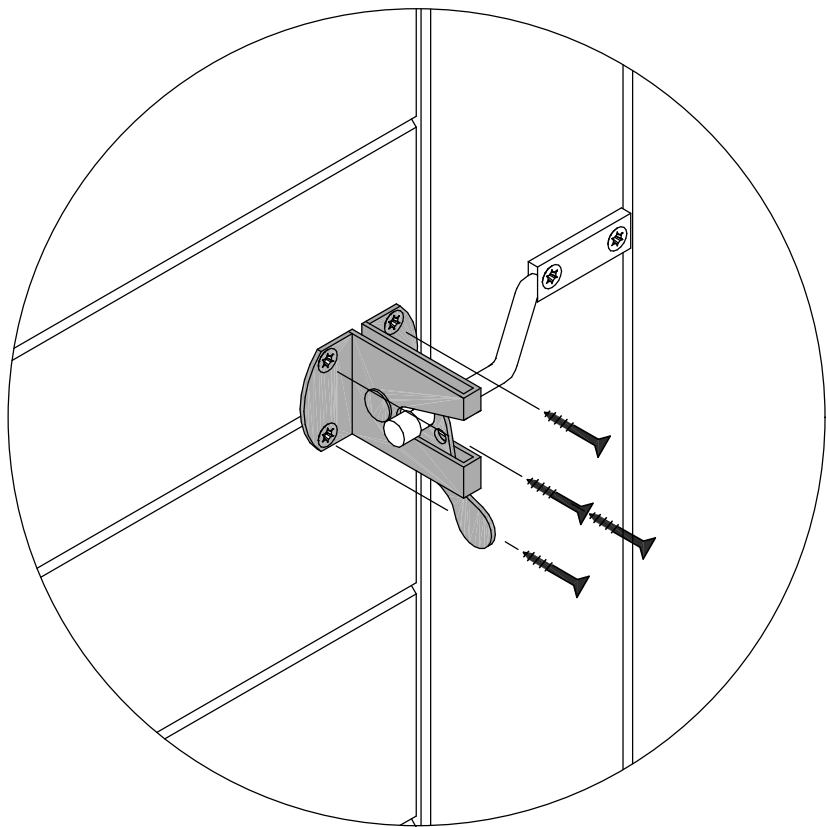

23

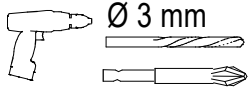

4x

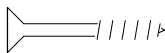

cod.
20027

1x

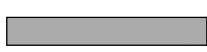

W

