

ORBIS® DISC

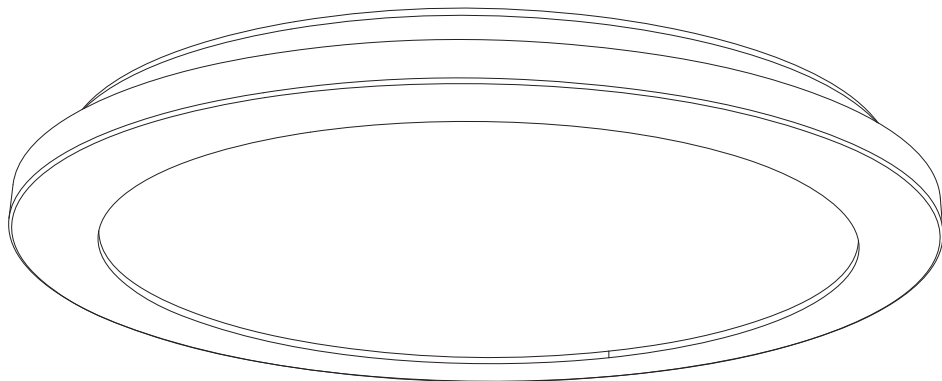

LEDVANCE



| | EAN | W | lm Light Source | lm Output | K | Temp (°C) | V~ | mA | Hz | DF | Beam (°) | Life (h) |
|--|---------------|----|-----------------------|--------------|---------------|---------------|-------------|-----|-------|------|-------------|-------------|
| ORBIS DISC 30CM 22WCLICKCCT IP44 CH | 4099854279591 | 22 | 3000 | 1800 | 3000/ 4000 | -20... +40 | 220- 240 | 116 | 50/60 | >0.7 | 120 | 10000 |
| ORBIS DISC 30CM 22WCLICKCCT IP44 WT | 4099854279614 | 22 | 3000 | 1800 | 3000/ 4000 | -20... +40 | 220- 240 | 116 | 50/60 | >0.7 | 120 | 10000 |
| ORBIS DISC 30CM 22WCLICKCCT IP44 WD | 4099854279638 | 22 | 3000 | 1800 | 3000/ 4000 | -20... +40 | 220- 240 | 116 | 50/60 | >0.7 | 120 | 10000 |

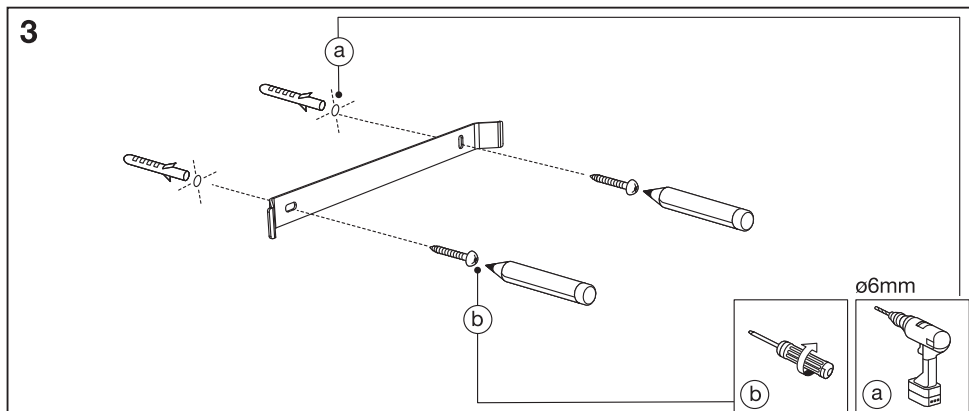
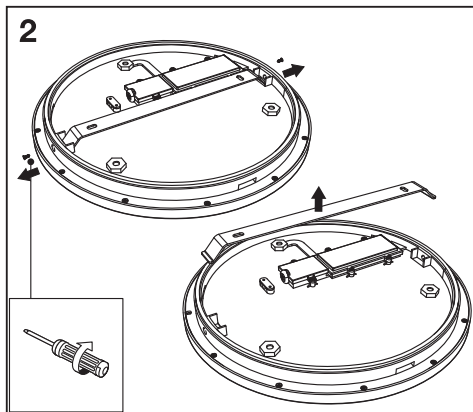
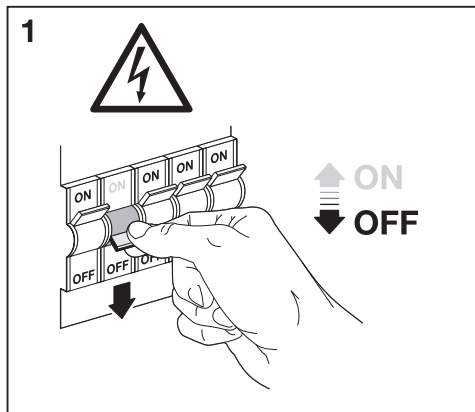
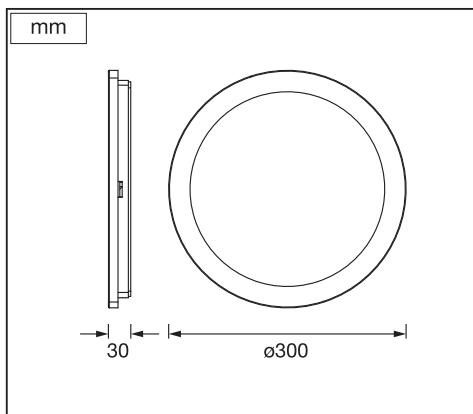
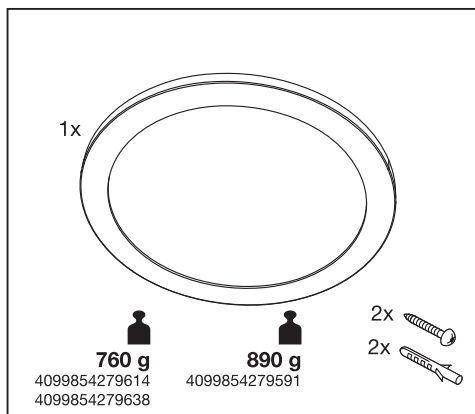

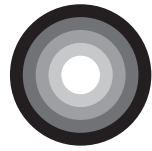

4

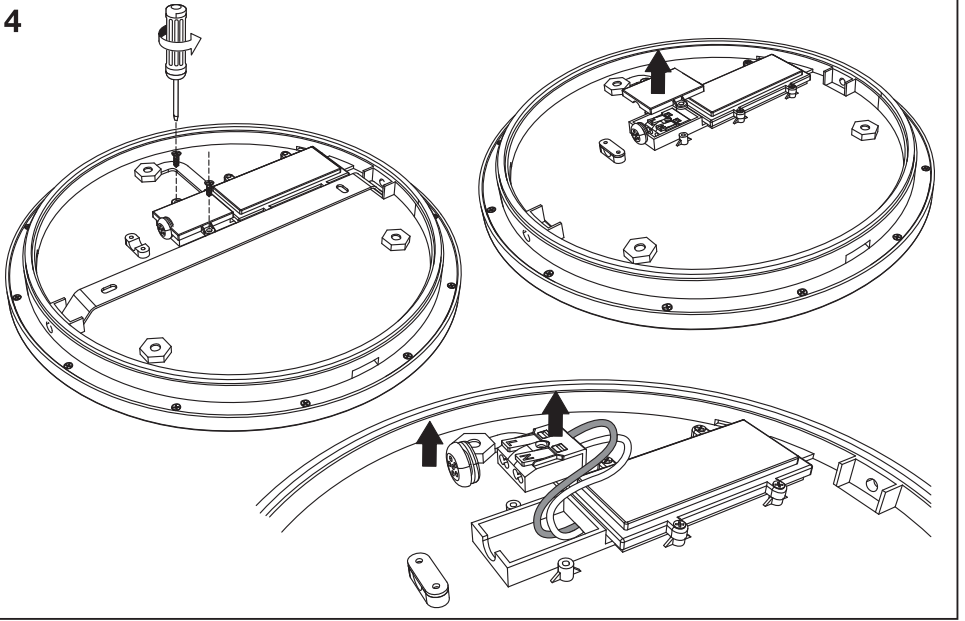

5

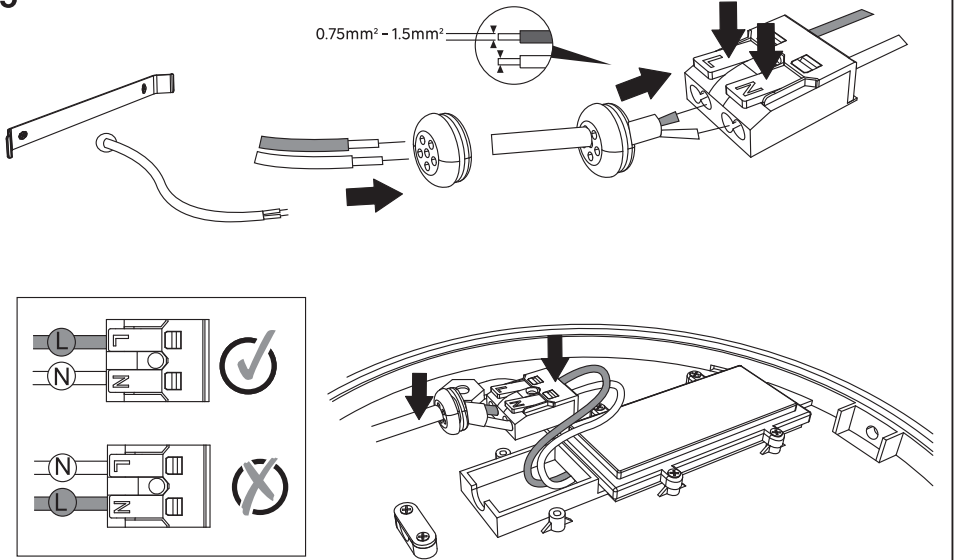





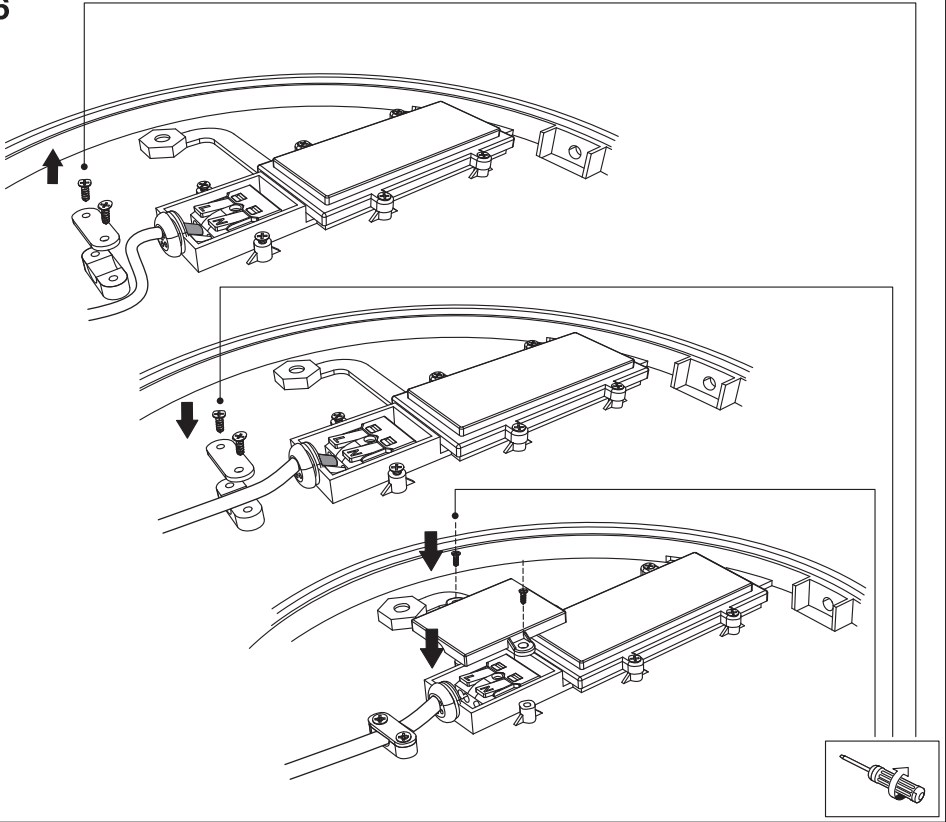

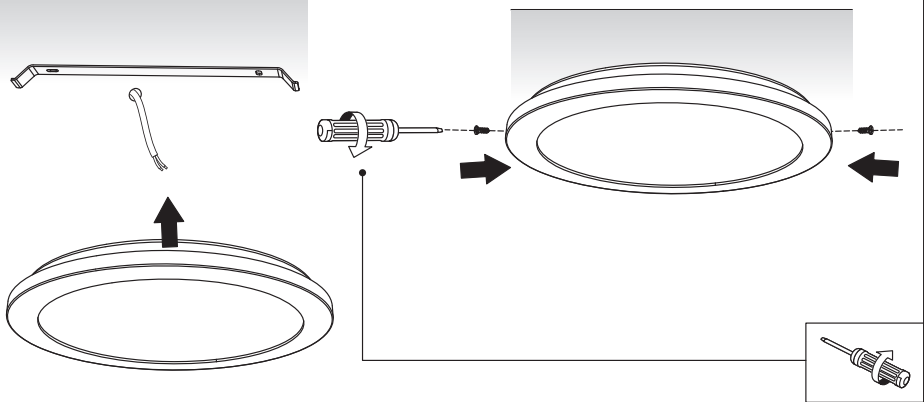

6

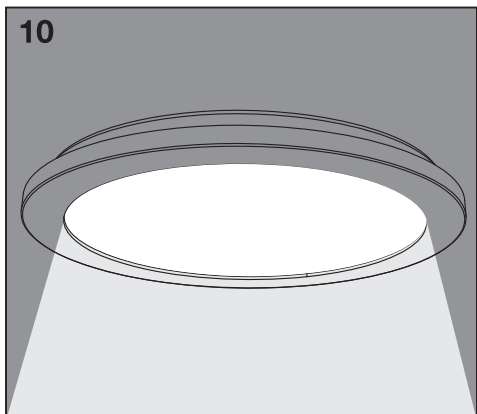
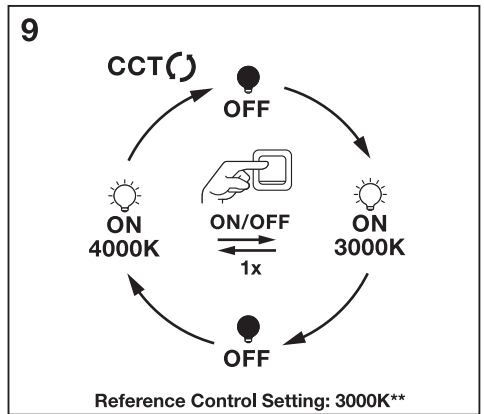
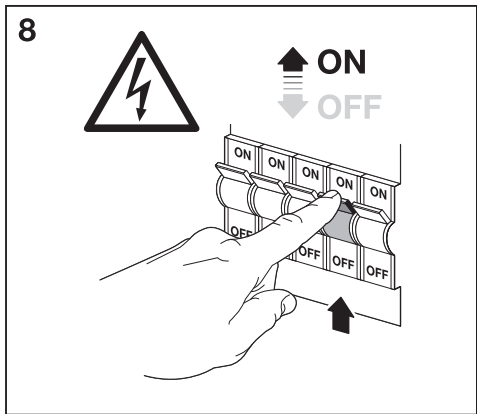





















































7





| | | | |  |
|--|---------------|---|---|--|
| | EAN | n |  |  ENERGY * X = |
| ORBIS DISC 30CM 22WCLICKCCT IP44 CH | 4099854279591 | 1 | AC60815 |  D |
| ORBIS DISC 30CM 22WCLICKCCT IP44 WT | 4099854279614 | 1 | AC60815 |  D |
| ORBIS DISC 30CM 22WCLICKCCT IP44 WD | 4099854279638 | 1 | AC60815 |  D |

*  Dieses Produkt enthält eine Lichtquelle der Energieeffizienzklasse <X>.  This product contains a light source of energy efficiency class <X>.  Ce produit contient une source lumineuse de classe d'efficacité énergétique <X>.  Questo prodotto contiene una sorgente luminosa di classe di efficienza energetica <X>.  Este producto contiene una fuente luminosa de la clase de eficiencia energética <X>.  Este produto contém uma fonte de luz da classe de eficiência energética <X>.  Το προϊόν αυτό περιέχει φωτεινή πηγή της τάξης ενεργειακής απόδοσης <X>.  Dit product bevat een lichtbron van energie-efficiëntieklasse <X>.  Tämä tuote sisältää valonlähteen, jonka energiatehokkuusluokka on <X>.  Dette produktet inneholder en lyskilde med energieffektivitetsklasse <X>.  Dette produkt indeholder en lyskilde i energieffektivitetsklasse <X>.  Tento výrobek obsahuje světelný zdroj s třídou energetické účinnosti <X>.  Данный продукт содержит энергосберегающий источник света (класс <X>).  Ez a termék egy <X> energiatékonysági osztályú fényforrást tartalmaz.  Ten produkt zawiera źródło światła o klasie efektywności energetycznej <X>.  Tento výrobok obsahuje svetelný zdroj triedy energetickej účinnosti <X>.  Та изделек vsebuje svetlobni vir razreda energetske učinkovitost <X>.  Acest produs conține o sursă de lumină cu clasa de eficiență energetică <X>.  Тоzi продукт включва светлинен източник с клас на енергийна ефективност <X>.  Toode sisaldab energiatõhususe klassi <X> valgusallikat.  Šiame gaminyje yra šviesos šaltinis, kurio energijos vartojimo efektyvumo klasė <X>.  Ši s ražojums satur gaismas avotu, kura energoefektivitātes klase ir <X>.  Ovaj proizvod sadrži izvor svetlosti klase energetske efikasnosti <X>.  Цей виріб містить джерело світла класу енергоефективності <X>.  Бул өнімде <X> энергия тиімділігі класының жарық көзі бар.

**  Referenzkontrollinstellung  Réglage de la commande de référence.  Impostazione controllo di riferimento  Configuración de control de referencia  Configuração de controlo de referência.  Ρύθμιση χειρισμού αναφοράς  Referentiebesturingsinstelling  Inställning för referenskontroll  Vertailuasetus  Referansekontrollinstilling  Referençenkontrollinstilling  Nastavenie referenčního ovládaní  Настройка эталонного контроля  Referencia vezérlés beállítása  Ustawienie kontroli wartości odniesienia  Nastavenie referenčného ovládania  Nastavitev referenčnega nadzora  Referans kontrol ayarı  Referența kontrolna postavka  Setare control de referință  Настройка на референция контрол  Võrdluskontrolli seadistus  Etaloninio valdymo nustatymas  Atsauces vadības iestatījums  Postavka kontrole reference  Налаштування еталонного контролю  Анықтамалық Басқару Параметрлері

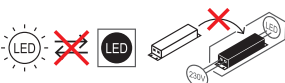

C10567405
G11187980
24.05.2024



LEDVANCE GmbH
Steinerne Furt 62
86167 Augsburg, Germany
www.ledvance.com