



- DE** ACHTUNG! NICHT FÜR KINDER UNTER DREI JAHREN GEEIGNET. Kleinteile und/oder abreißbare Kleinteile enthalten, die z.B. verschluckt werden könnten. Erststückergefahr. Enthält Teile mit Schläuchen, Schnüren, Bändern o.ä. Strangulierungsgefahr. Adresse und Information aufbewahren.
- EN** WARNING! NOT SUITABLE FOR CHILDREN UNDER THREE YEARS. Contains small parts and/or small parts that can be torn off and may, for example, be swallowed. Choking hazard. Contains parts with tubes, cords, tapes or similar. Risk of strangulation. Please keep the supplied address and information.
- FR** ATTENTION ! NE CONVIENT PAS AUX ENFANTS DE MOINS DE TROIS ANS. Contient des éléments de petite taille et/ou arrachables pouvant par exemple être avalés. Danger d'étouffement. Contient des éléments tels que tuyaux, cordons, rubans etc. Danger de strangulation. Adresse et informations à conserver.
- ES** ¡ADVERTENCIA! NO CONVIENE PARA NIÑOS MENORES DE TRES AÑOS. Contiene piezas pequeñas y/o piezas pequeñas desmontables que p.ej. pueden ser ingeridas. Peligro de asfixia. Contiene p.ej. piezas con tubos, cordones, cintas, o similares. Peligro de estrangulamiento. Guardar la dirección e informaciones.
- IT** AVVERTENZA! NON ADATTO A BAMBINI DI ETÀ INFERIORE A TRE ANNI per la presenza di piccole parti che potrebbero essere ingerite e/o inalate. Pericolo di soffocamento. Contiene parti con tubicini, cordini, lacci o simili. Rischio di strangolamento. Conservare l'indirizzo del fabbricante e il foglio informativo.
- NL** WAARSCHUWING! NIET GESCHIKT VOOR KINDEREN JONGER DAN DRIE JAAR. Bevat kleine onderdelen en/of afscheurbare kleine onderdelen, die bijv. ingeslikt kunnen worden. Verstikkingsgevaar. Bevat onderdelen met slangen, snoeren, linten, o.a. Ophangingsgevaar! Adres en informatie bewaren.
- PT** ATENÇÃO! CONTRAINDICADO PARA CRIANÇAS COM MENOS DE 3 ANOS. Contém peças pequenas e/ou peças pequenas que podem ser arrancadas podendo, por exemplo ser engolidas. Perigo de asfixia. Contém peças com tubos, cordões, fitas ou outros. Perigos de estrangulamento. Guardar o endereço e as informações.
- RU** ПРЕДУПРЕЖДЕНИЕ! НЕ ПРЕДНАЗНАЧЕНО ДЛЯ ДЕТЕЙ ВОЗРАСТОМ ДО 36 МЕСЯЦЕВ. Содержит мелкие или отделяемые детали, которые, например, могут быть проглочены. Опасность удушья. Детали со шлангами, шнурами, лентами и т.п. Опасность удушья. Сохранить адрес и указания.
- CS** UPOZORNĚNÍ! NEVHODNÉ PRO DĚTI DO TŘÍ LET. Obsahuje malé díly a/nebo oddělitelné části, které mohou děti spolknout. Nebezpečí udušení. Obsahuje malé části, jako jsou hadičky, provázky, pásky apod. – nebezpečí úskrcení. Adresu a informace uschovejte.
- PL** OSTRZEŻENIE! NIE NADAJE SIĘ DLA DZIECI W WIEKU PONIŻEJ 3 LAT. Zawiera małe lub pozwalające się oderwać elementy, które mogłyby zostać np. połknięte. Niebezpieczeństwo uduszenia. Zawiera elementy takie jak węże, sznurki i taśmyki itp. Niebezpieczeństwo uduszenia. Zachować adres i informacje do wykorzystania w przyszłości.
- SL** OPOZORILO! NI PRIMERNO ZA OTROKE MLAJŠE OD TREH LET. Vsebuje manjše in/ali lomljive dele, ki predstavljajo nevarnost zaužitja. Nevarnost zadušitve. Vsebuje dele, kot so zanke, vezalke, trakovi itd. Nevarnost strangulacije. Shranite naslov in informacije.
- SV** VARNING! INTE LÄMPLIG FÖR BARN UNDER TRE ÅR. Innehåller smådelar och/eller delar som kan lossna, och som till exempel skulle kunna sväljas. Risk för kvävning. Innehåller delar med slangar, snören, band, mm. Risk för strypning. Spara adress och information.
- NO** ADVARSEL! IKKE EGNET FOR BARN UNDER 3 ÅR. Inneholder smådelar og/eller avrivable smådelar som f.eks. kan svelges. Kvelningsfare. Inneholder deler med slanger, snorer, bånd o.l. kvelningsfare. Oppbevar adressen og informasjonen.
- DA** ADVARSEL! IKKE EGNET FOR BØRN UNDER TRE ÅR. Indeholder smådele og/eller afrikelige smådele, der f.eks. kan sluges. Kvælningsfare. Indeholder dele med slanger, snore, bånd o.l. Fare for strangulering. Gem adressen og oplysningerne.
- FI** VAROITUS! EI SOVELLU ALLE KOLMIVUOTIAILLE. Sisältää pienosia ja/tai irtilähtevä pienosia, jotka on mahdollista esim. niellä. Tukeutumisvaara! Sisältää osia, joissa on letkuja, nauhoja, nauhoja ym. Kuristumisvaara! Osioita ja tiedot on säilytettävä.
- HU** FIGYELMEZTETÉS! CSAK HÁROM ÉVNÉL IDŐSEBB GYERMEKEK SZÁMÁRA ALKALMAS. Lenyelhető és/vagy letéphető apró darabokat tartalmaz. Fulladásveszély! Műanyag csöves, zsinóros, szalagos stb. alkatrészeket tartalmaz. Fojtási veszély! A címet és tudnivalókat meg kell őrizni.
- EL** ΠΡΟΕΙΔΟΠΟΙΗΣΗ! ΔΕΝ ΕΙΝΑΙ ΚΑΤΑΛΛΗΛΟ ΓΙΑ ΠΑΙΔΙΑ ΚΑΤΩ ΤΩΝ ΤΡΙΩΝ ΕΤΩΝ. Περιλαμβάνονται μικρά κομμάτια τα οποία π.χ. μπορεί να καταπούν τα παιδιά. Κίνδυνος πνιγμού. Περιέχει μέρη με ελαστικούς σωλήνες, κορδόνια, ταινίες κ.ο.κ. Κίνδυνος στραγγαλισμού. Φυλάξτε τη διεύθυνση και τις πληροφορίες.
- JA** 警告！生後36ヶ月以下の幼児には与えないでください。小さな部品、または外れる可能性のある小さな部品を含み、これをお子様か飲み込んでしまう恐れがあります。窒息する危険があります。小さいチューブやコード、テープ状の部品が含まれており、窒息死する危険があります。連絡先および説明書を保管してください。
- AR** تحذير ! غير صالح مطلقاً للأطفال من تحت الـ 36 شهرا من العمر . لإحتوائها على قطع صغيرة أو على قطع صغيرة قابلة للإنزراع والتي على سبيل المثال من الممكن أن تبتلع . خطر الإختناق . يحتوي على قطع من خراطيم " نرابيش " ، على خيوط سمكية وعلى الشريطة مختلفة وغير ها مما يماثلها ؛ خطر الخنق .
- ZH** 警告！不适合36个月以下的儿童。内含小零件和（或）易断裂的小零件，请避免不慎吞食等情况发生。可能有窒息的危险。零部件可能带有软管以及绳带，引发勒颈窒息危险。保存地址和信息。



BOSCH



Tool Truck Set WITH BOSCH IXOLINO II



MONTAGEANLEITUNG
ASSEMBLY INSTRUCTIONS
NOTICE DE MONTAGE
INSTRUCCIÓN DE MONTAJE
HANDLEIDING
ISTRUZIONI DI MONTAGGIO



Toys - made with passion!

www.klein-toys.com

 1x	 1x	 1x	 1x	 1x
 1x	 1x	 1x	 1x	 1x
 1x	 1x	 8x	 1x	 1x
 1x	 1x	 1x	 1x	 4x
 4x	 3x	 26x	 1x	 1x
 1x	 7x	 1x	 1x	 1x
 1x	 1x	 1x	 1x	 4x

First Steps:

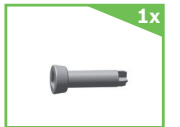
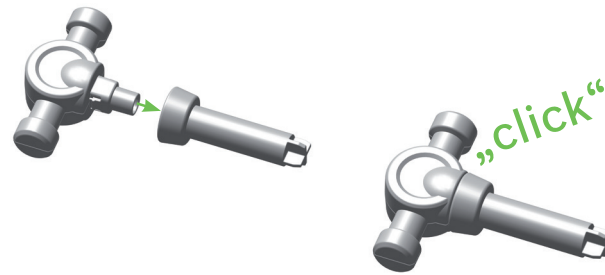

A

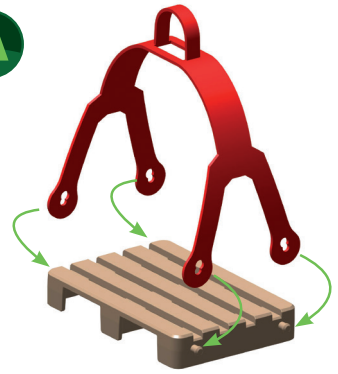

B

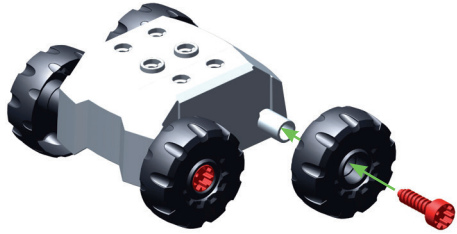
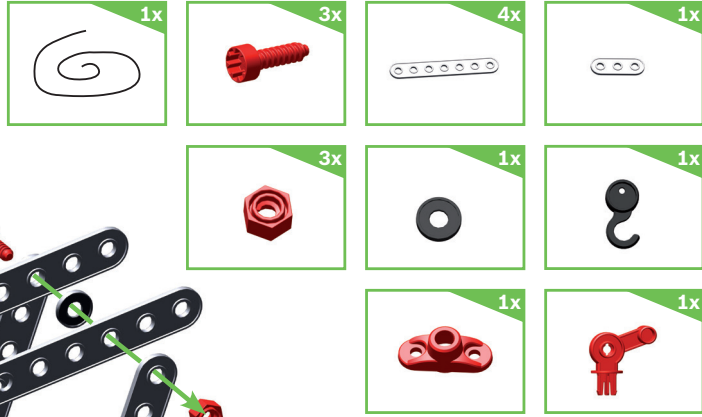
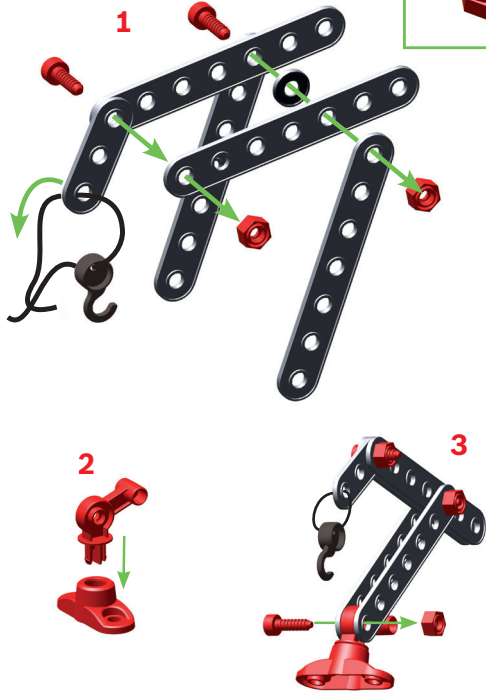
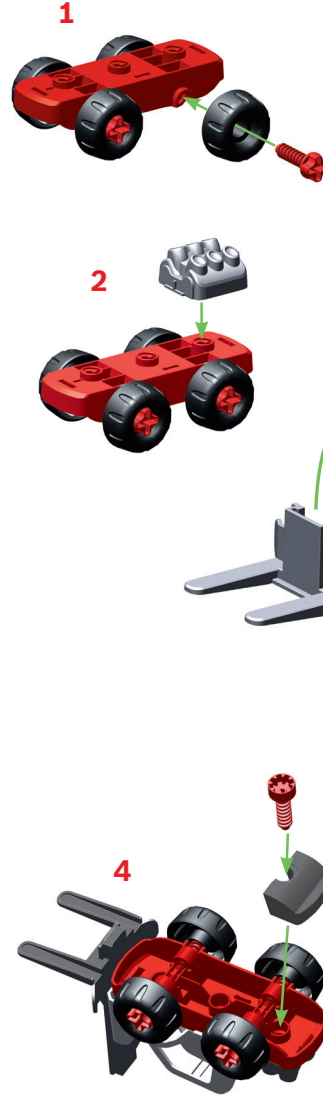

C**D****E**

F

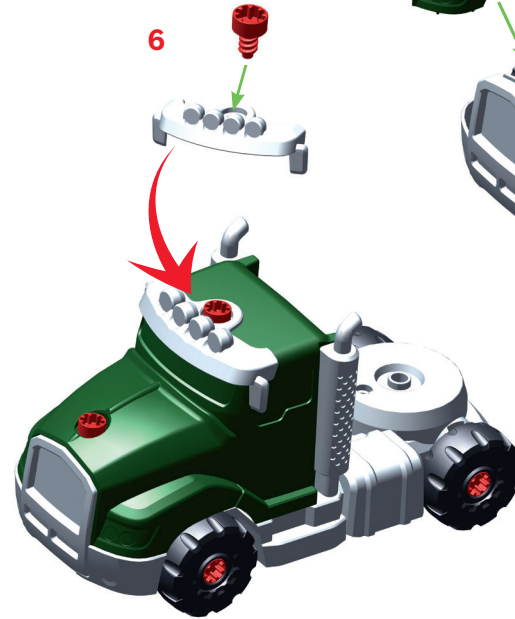
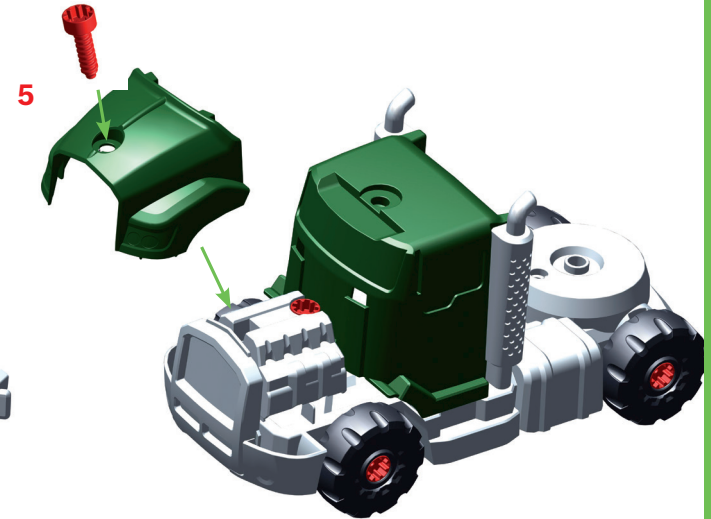
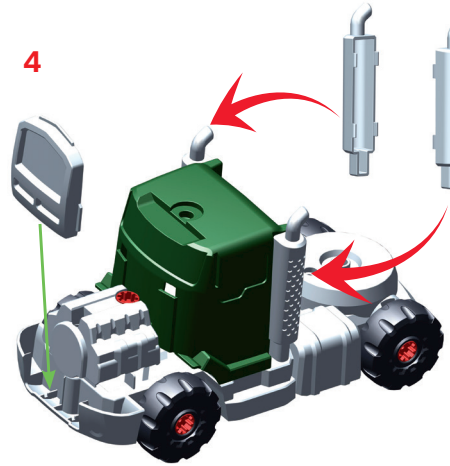
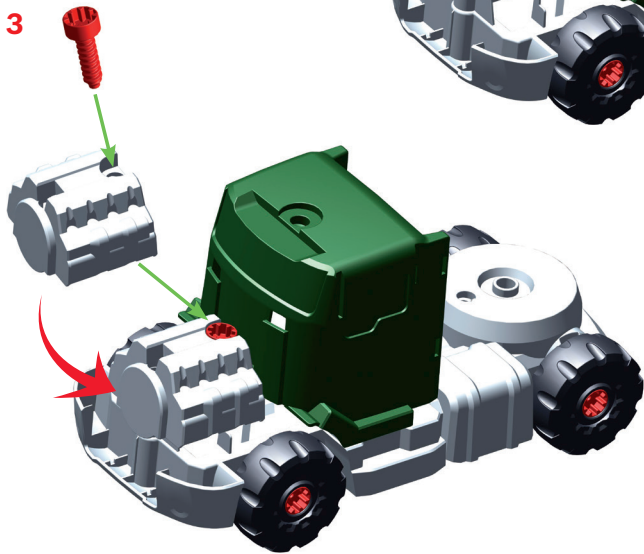
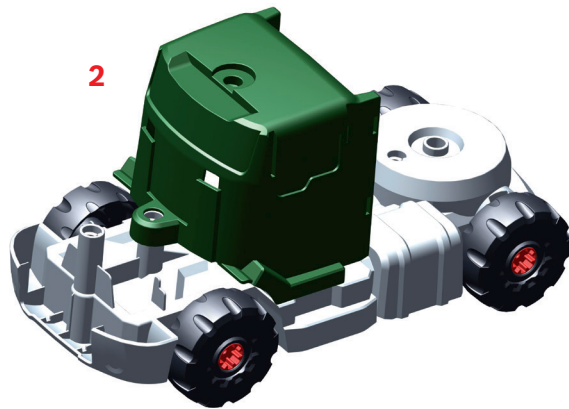
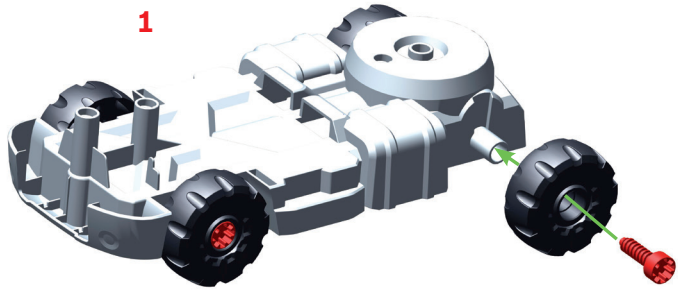
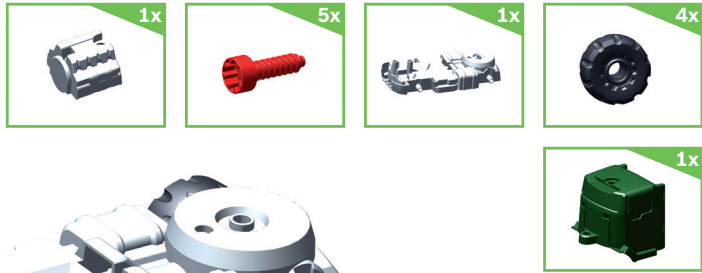

1

SEITE
PAGE • PAGINA
9



1

1

B + **C** + **F**

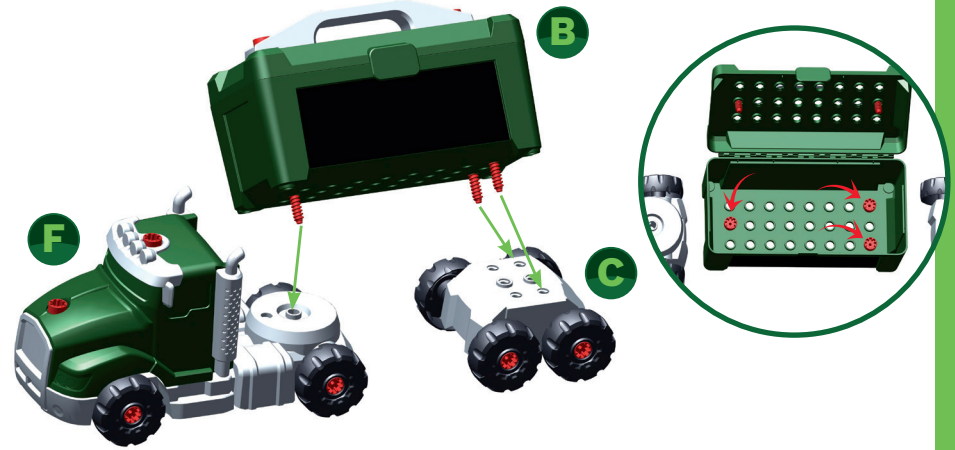

2

SEITE
PAGE • PAGINA
10

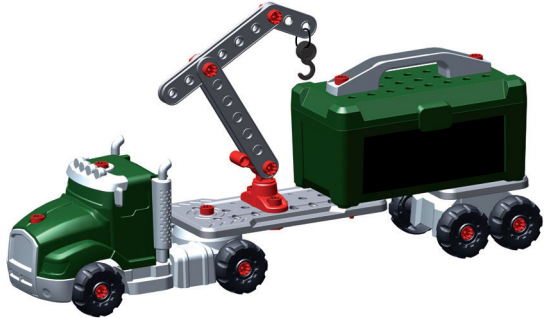

2



3

SEITE
PAGE • PAGINA
12



4

SEITE
PAGE • PAGINA
14



2

1

B + C + D + F



2.B

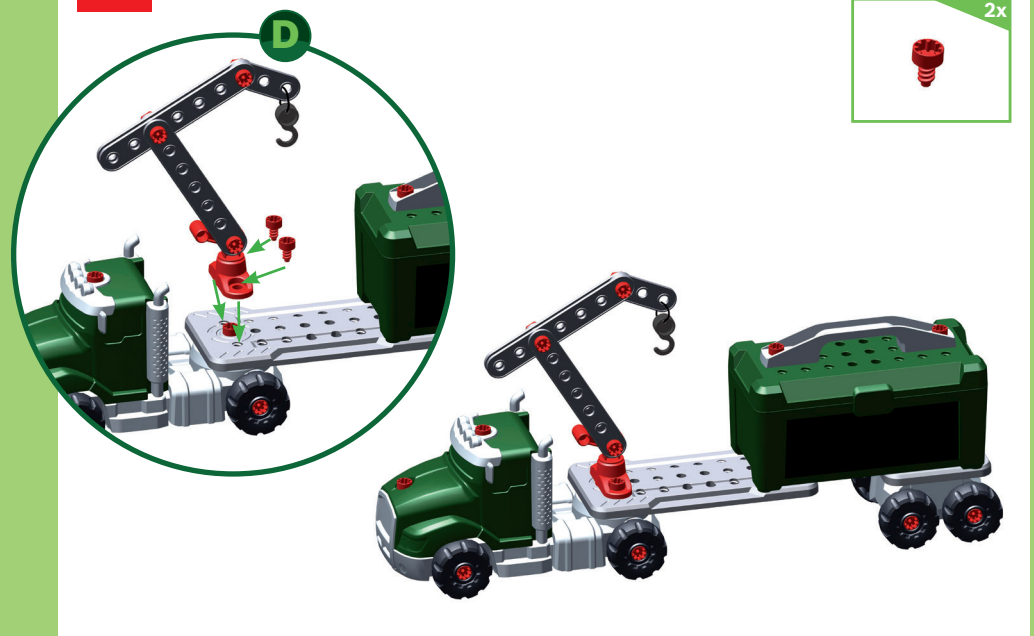



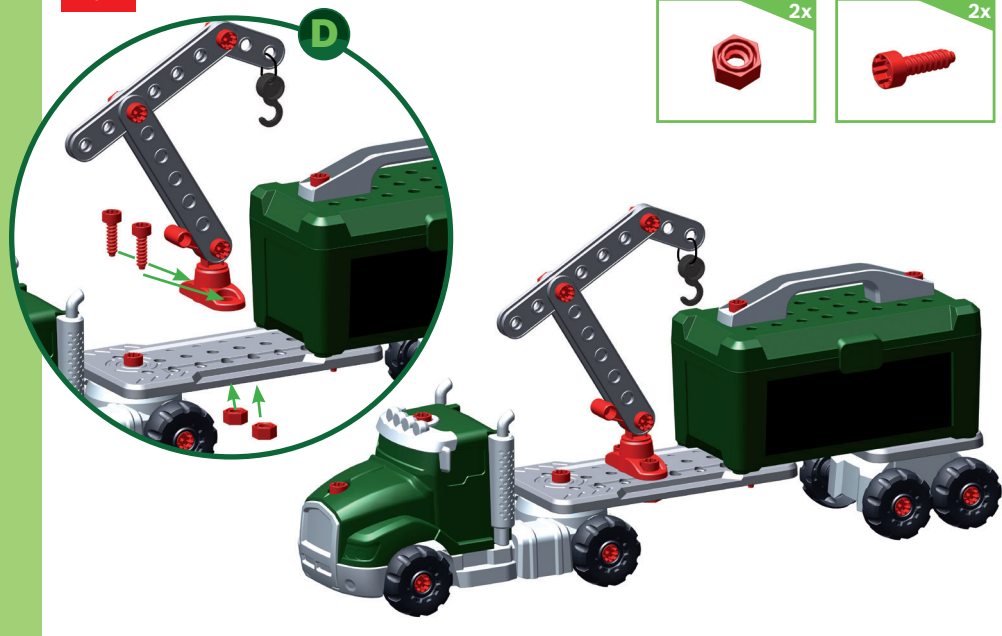

2.A



3

1

A + B + C + E + F

- | | |
|--|---|
|  2x |  7x |
|  1x |  1x |

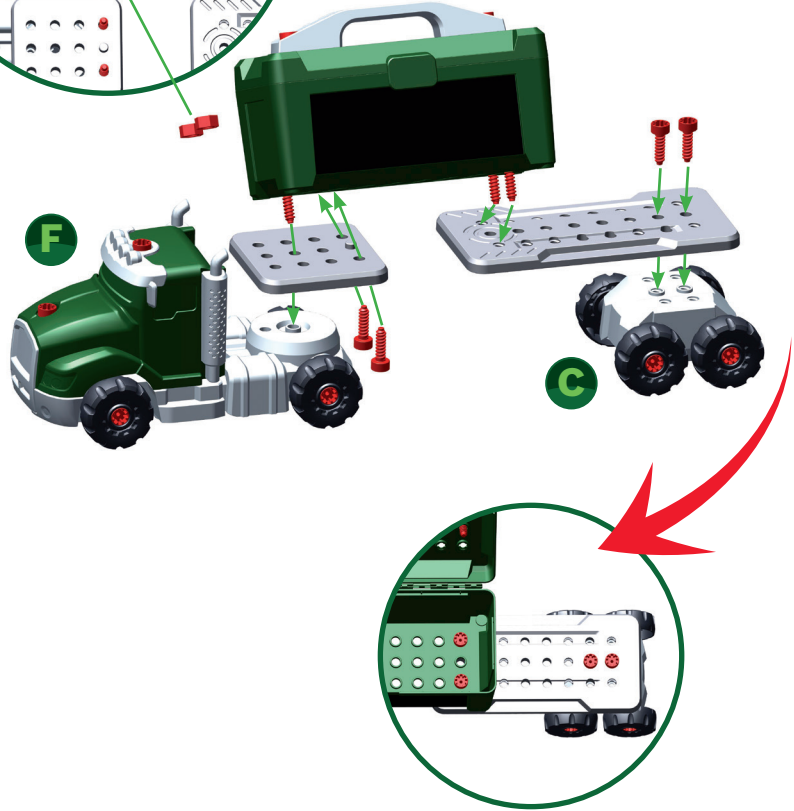
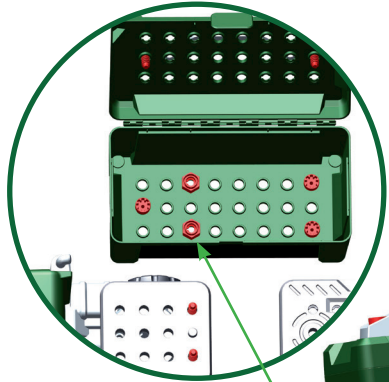

2

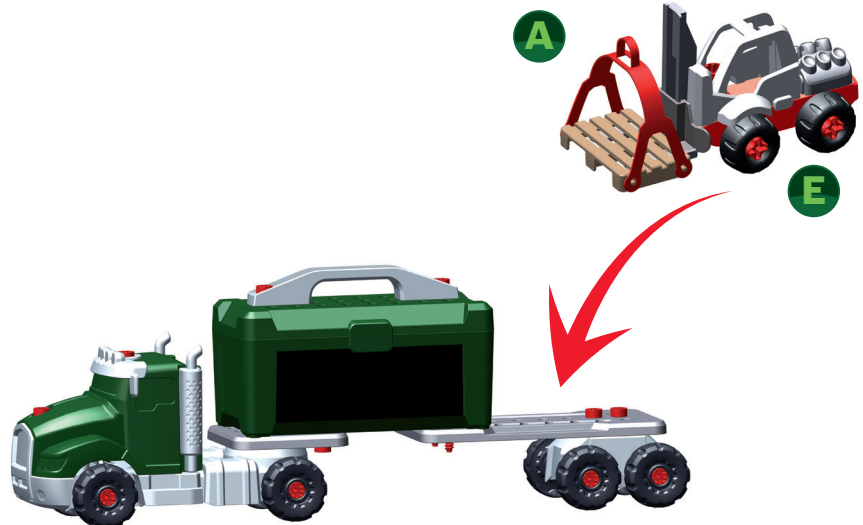

3

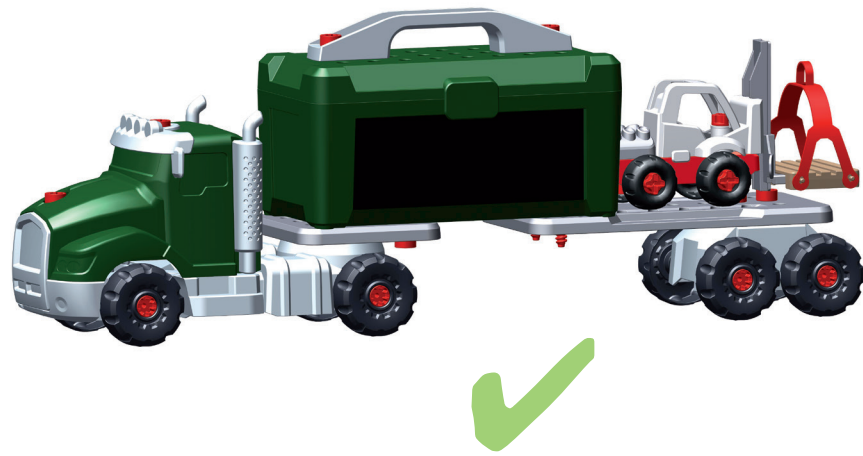

4

1

A + B + C + D + E + F

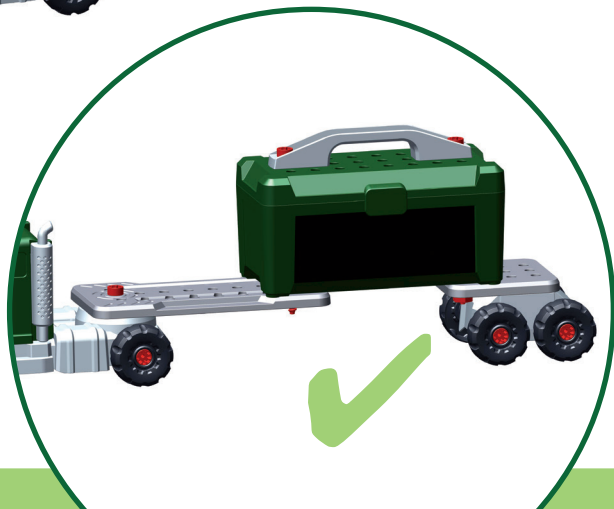
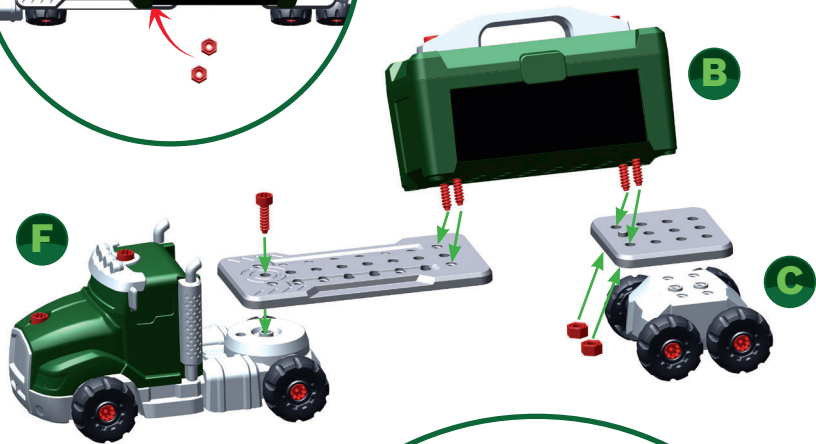
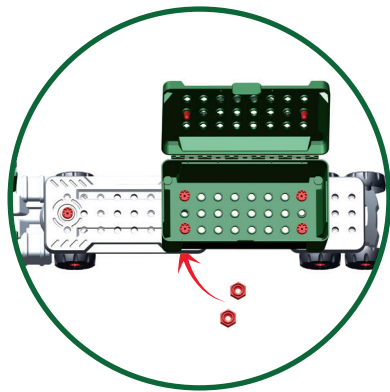

2

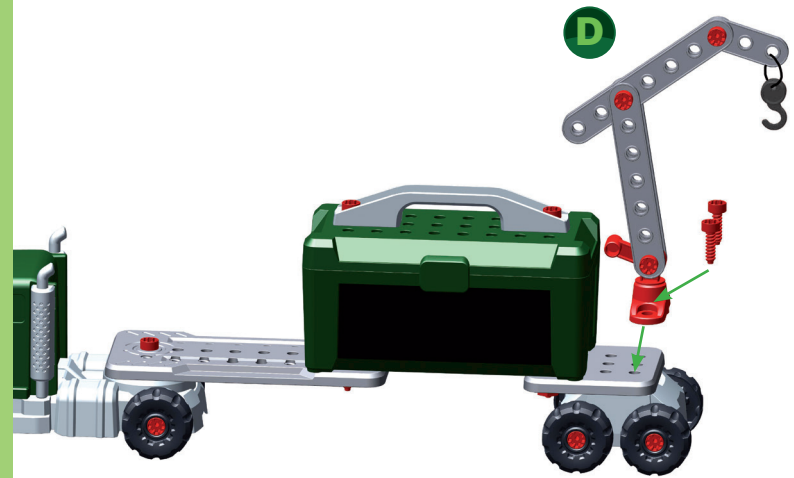

3

