



MAKALU BE 45x40 1C R-10 - A. inox. 304

Ean-13: 8422248081191 - Cód.: 950270031

- ✓ Fregadero bajo encimera o con instalación enrasada, de acero inoxidable 304, de 1,2 mm de grosor
- ✓ 1 cubeta cuadrada con base de pirámide invertida
- ✓ Fregadero sin orificio de grifería
- ✓ Profundidad de la cubeta de 20 cm
- ✓ Desagüe con válvula canasta cuadrada 3 1/2"
- ✓ Accesorios incluidos: válvula cuadrada, sifón y tubo rebosadero
- ✓ Instalación en mueble de 60 cm
- ✓ Dimensiones (largo x ancho x profundo): 490 x 440 x 200 mm

*medidas en mm

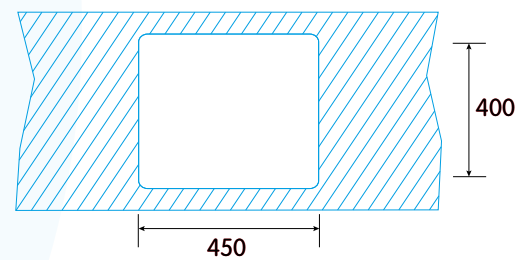
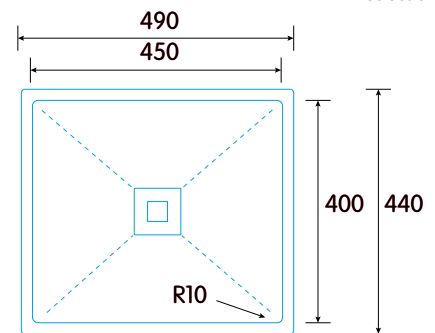

ACCESORIOS INCLUIDOS

07699003



07699009



07699008



BAJO ENCIMERA



ENRASADO



20 CM DE PROFUNDIDAD



ACERO INOXIDABLE ULTRA GRUESO



UNA CUBETA



PARA MUEBLE DE 60 CM