

100%

M000018

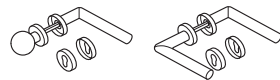

1 - 10

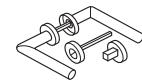

1 - 9 + 11

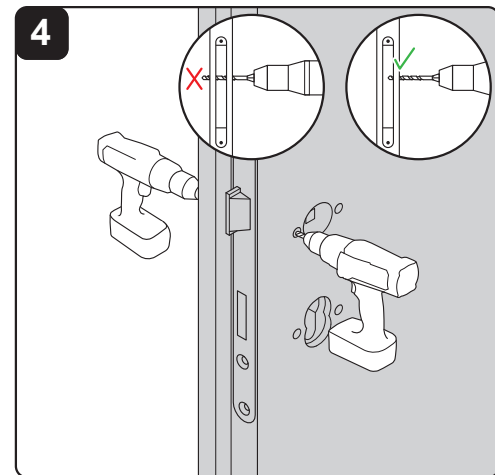
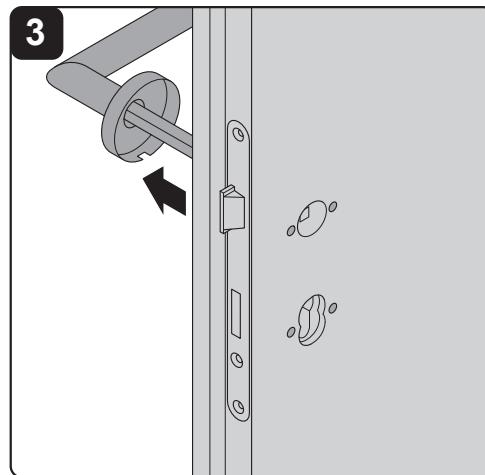
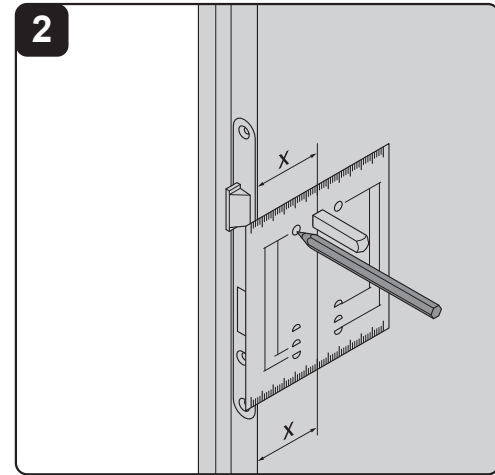
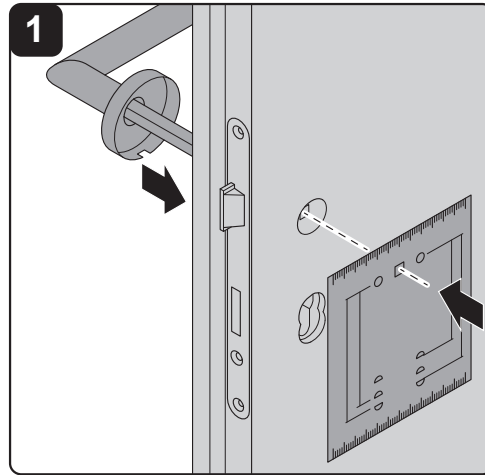

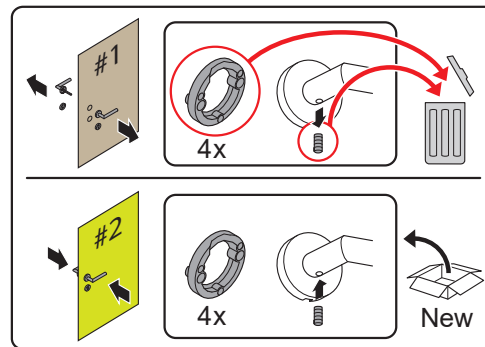
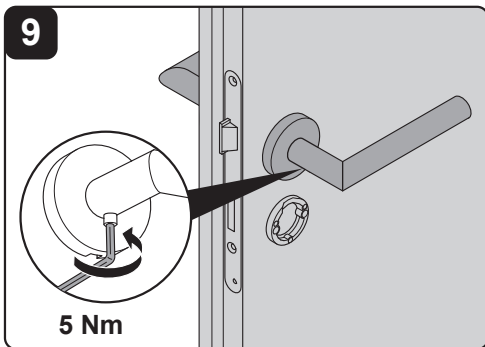
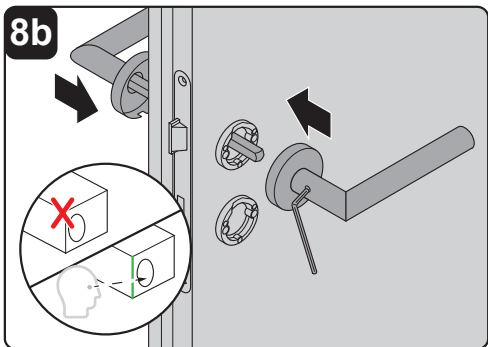
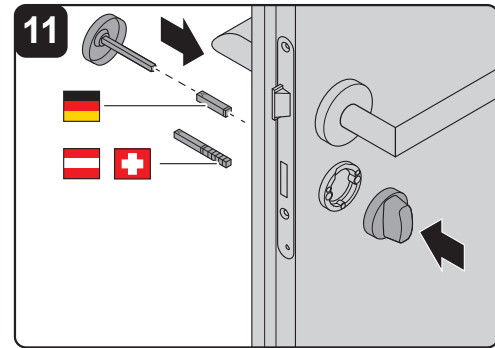
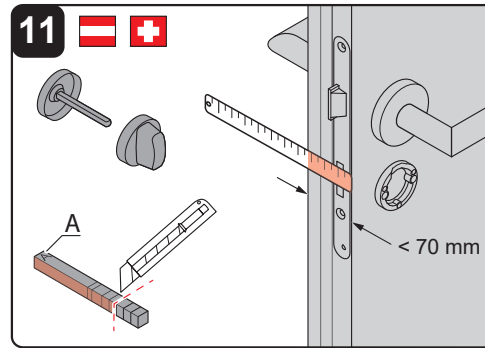
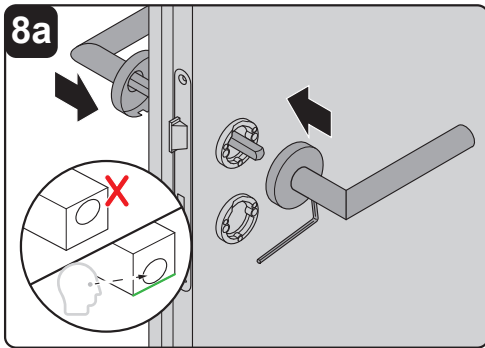
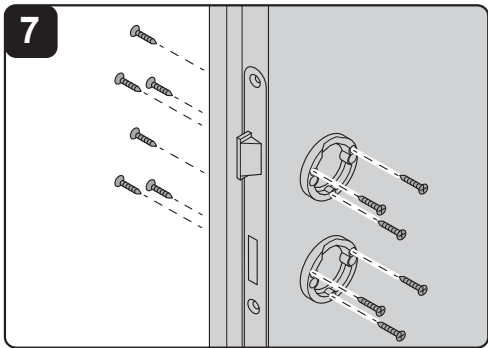
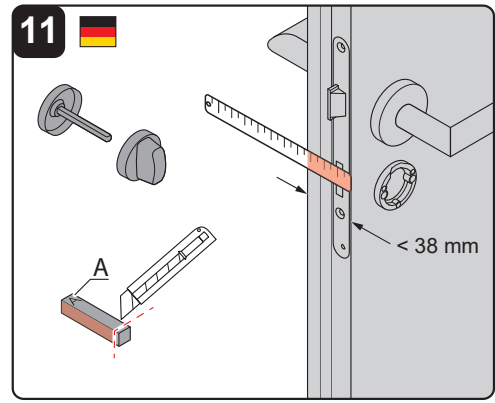
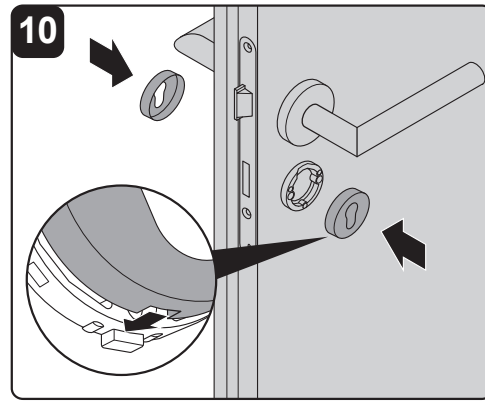
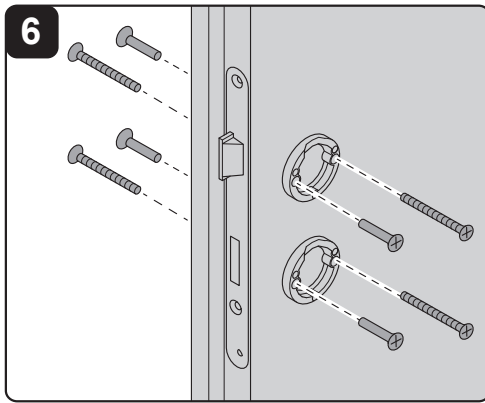
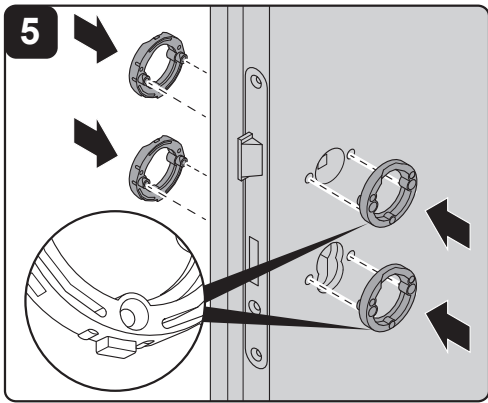

Technische Änderungen vorbehalten
subject to alterations as/08072021

GRIFFWERK GmbH
Lindenstraße 90
D-89134 Blaustein