

80L

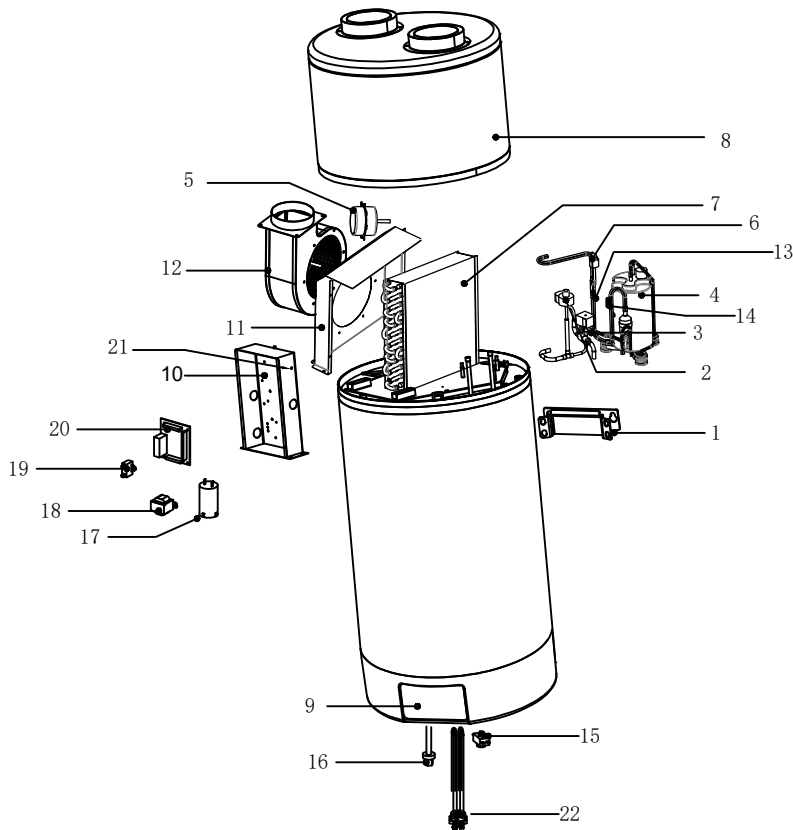

S/N	Code	Name
1	A0220075	Wall bracket
2	C0050017	Electronic expansion valve
3	C0020079	2-way valve
4	D0020121	Compressor
5	D0040078	Fan
6	C0070006	Low pressure switch
7	D0010062	Evaporator
8	A0170014	Top cover
9	G0020044	Control panel
10	A0050073	Electric control box
11	A0180008	Fan plate
12	A0210002	Fan casing
13	C0080005	Needle valve
14	G0030024	Temperature sensor
15	G0120002	Temperature control switch
16	D0100001	Magnesium
17	G0050024	Compressor capacitor
18	G0040001	Transformer
19	G0060010	Fan capacitor
20	G0010047	PCB
21	G0030023	Temperature sensor
22	D0090005	Electrical heater