

# POOLIMEX

## NIÁGARA Series

## POOLIMEX

## NIÁGARA Series

## POOLIMEX

## NIÁGARA Series

## POOLIMEX

# PRODUCT INFORMATION SUMMARY

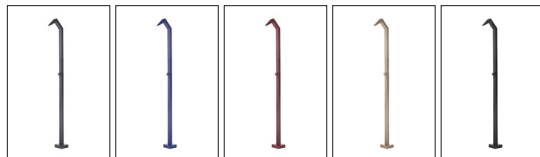

Ref.	EAN	Finish
GPN013/AC	8435668059008	ACERO S.316
GPN013/AAO	8435668060998	AZUL OCEANO
GPN013/ACL	8435668061001	ROSA CORAL
GPN013/AMK	8435668061018	MOKA
GPN013/AGCB	8435668061025	GRIS COBALTO
GPN013/ANG	8435668059015	NEGRO MATE

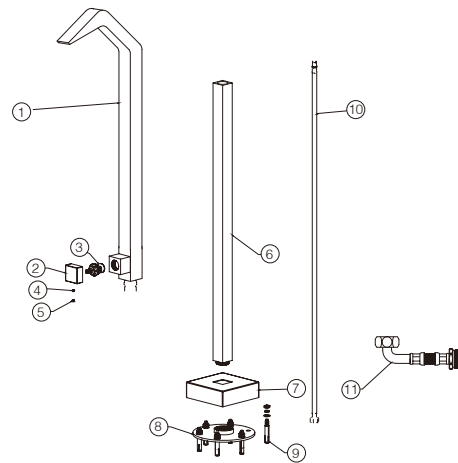

CODE	NAME	MATERIAL	REF
1	Upper pipe	SUS 316	
2	Handle	SUS 316	
3	Cartridge	assembly	Ø23.5MM
4	Screw	SUS 304	
5	Color button	NBR	
6	Down pipe	SUS 316	
7	Cover plate	SUS 316	
8	Fixed seat	SUS 316	
9	Screw	SUS 304	
10	Inlet pipe	SUS 316	
11	Elbow connection	SUS 316	

\* CONSULTAR PARA ACABADOS DE COLOR

### Installing instruction

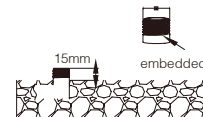

Step 1.Embedd water pipe underground

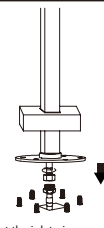

Step 2.Connect the inlet pipe

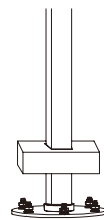

Step 3.Tighten the screws

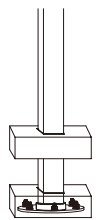

Step 4.Close the cover

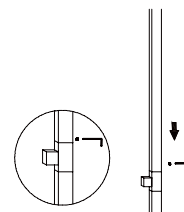

Step 5.Connect the faucet body with the pipes

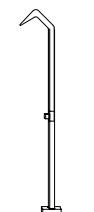

Step 6.Connect the shower head

NIÁGARA

Series

POOLIMEX

**FLOW RATE**

Detalles	
FLOW RATE REF	GPN013
Top shower 0.1Mpa(L/MIN)	5.3
Top shower 0.3Mpa(L/MIN)	14.1
Top shower 0.5Mpa(L/MIN)	19.6

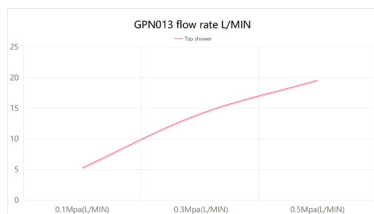

NIÁGARA

Series

POOLIMEX

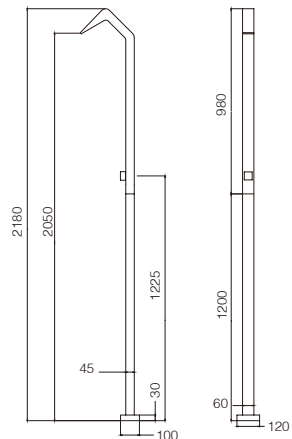

Product sizes (cm)	126.5*53.7*10.7
Weight (kg)	10.7
Guarantee	10 years
Max Preassure (bar)	8
Min Preassure (bar)	1
Optimum preassure (bar)	3-4
Max. temperature	55 °C
Min temperature	0 °C

NIÁGARA

Series

POOLIMEX

**CERTIFIES**

That all our products, provided that they are used in normal conditions or installed in accordance with current standards, are guaranteed against any manufacturing defect for a period of five years, except for products purchased before January 1, 2020, which will have the mandatory coverage of 2 years from the date of invoice.

Requirements and exclusions

Failure to comply with the instructions for assembly, use and maintenance of our products on the packaging and in our catalogue and published on our website: [www.imexproducts.es](http://www.imexproducts.es), releases IMEX PRODUCTS, S.L. from any liability.

In any case, the acceptance of the defect by our technical department is necessary. In addition, transport costs will be charged only in the event that on IMEX PRODUCTS, S.L. technician determines the proper functioning of our products.

IMEX PRODUCTS, S.L. will decide to repair the product or replace it. It will be necessary to present the purchase invoice.

Assembly, maintenance or repairs carried out by non-specialists are excluded from the warranty.

Wearing parts such as hoses, handles, seals, filters, aerators, etc. are not covered by the warranty.

