

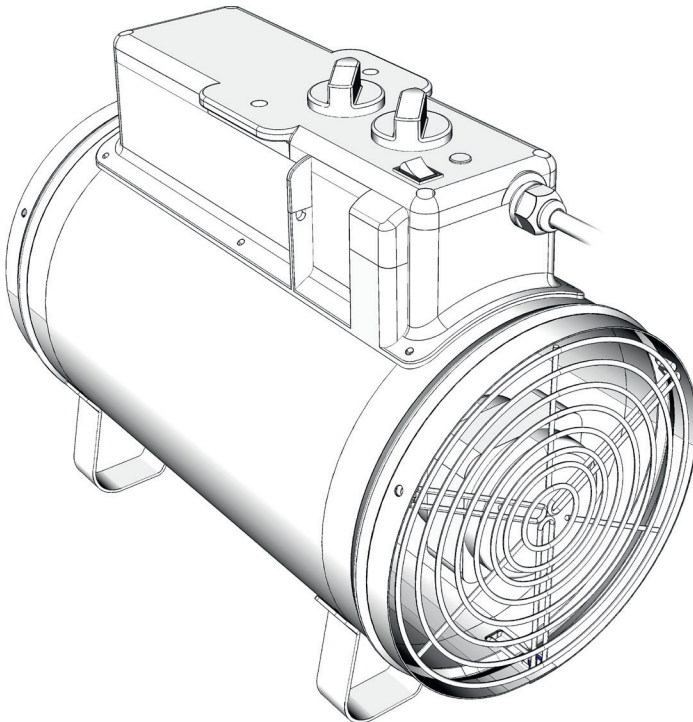

Installation and operating instruction
for Greenhouse heater

PHOENIX

PHX 2.8/PHX2.8/US



US

ES

FR

Quick reference guide

Power cord
Cordon d'alimentation
Cable de alimentación

Selector 2
Selector 2
Sélecteur 2

On/Off lamp
Lampe on / off
Lámpara de encendido / apagado

Selector 1  Air circulation only
Selector 1 1000 - 1000 Watt
Selector 1 1800 - 1800 Watt
Sélecteur 1 2800 - 2800 Watt

Thermostat	0 - 1 ≈ 32 - 37 °F	0 - 2.6 °C
Termostato	1 - 2 ≈ 37 - 42 °F	2.6 - 5.2 °C
Termostato	2 - 3 ≈ 42 - 46 °F	5.2 - 7.8 °C
Termostato	3 - 4 ≈ 46 - 51 °F	7.8 - 10.4 °C

Bimetallic temperature controller
Régulateur de température bimétallique
Controlador de temperatura bimetalico

Feets for floor mounting
Pieds pour montage au sol
Pies para el montaje en el piso

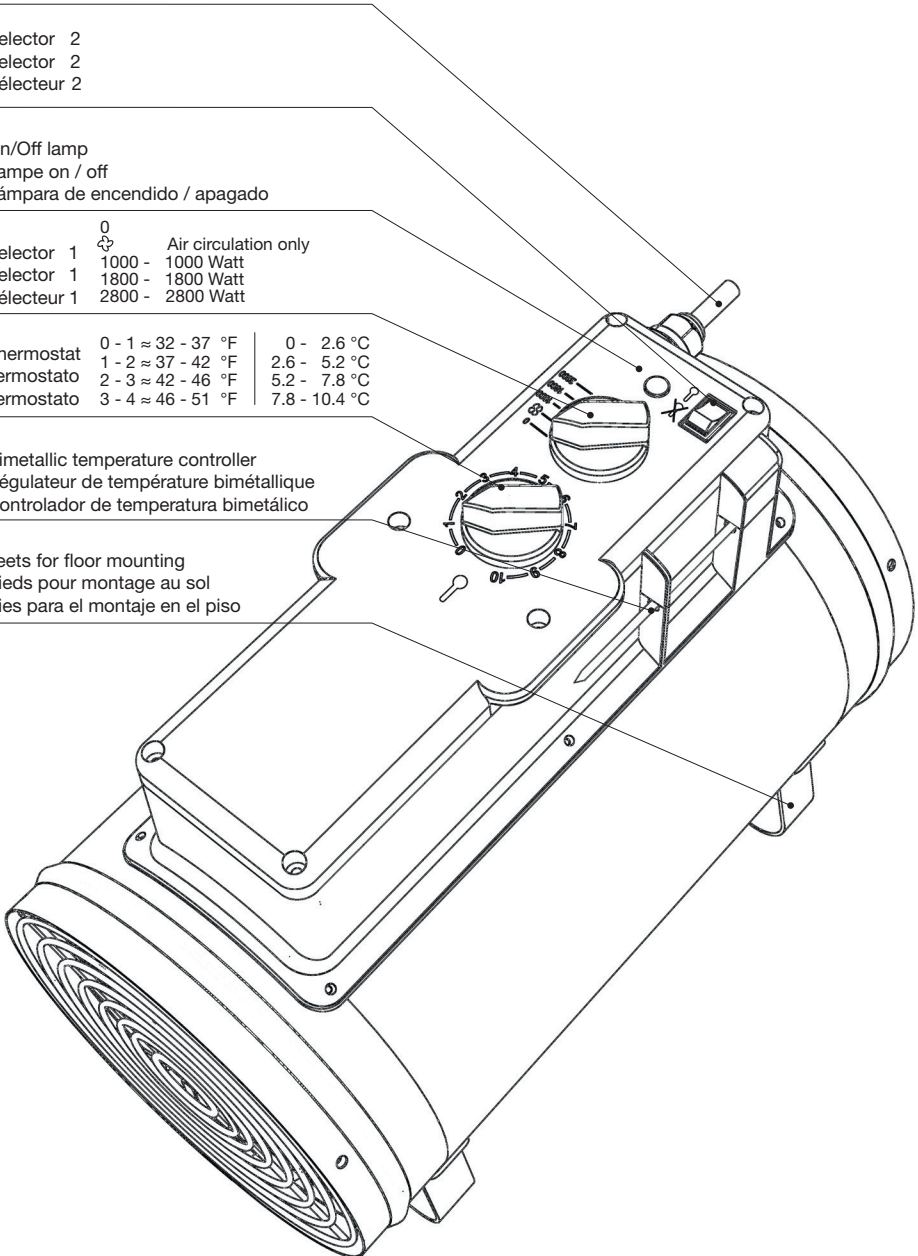

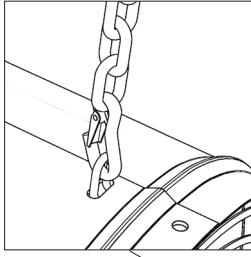
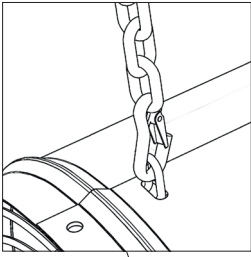

Eyelets for ceiling mounting
Œillets pour montage au plafond
Ojales para montaje en el techo

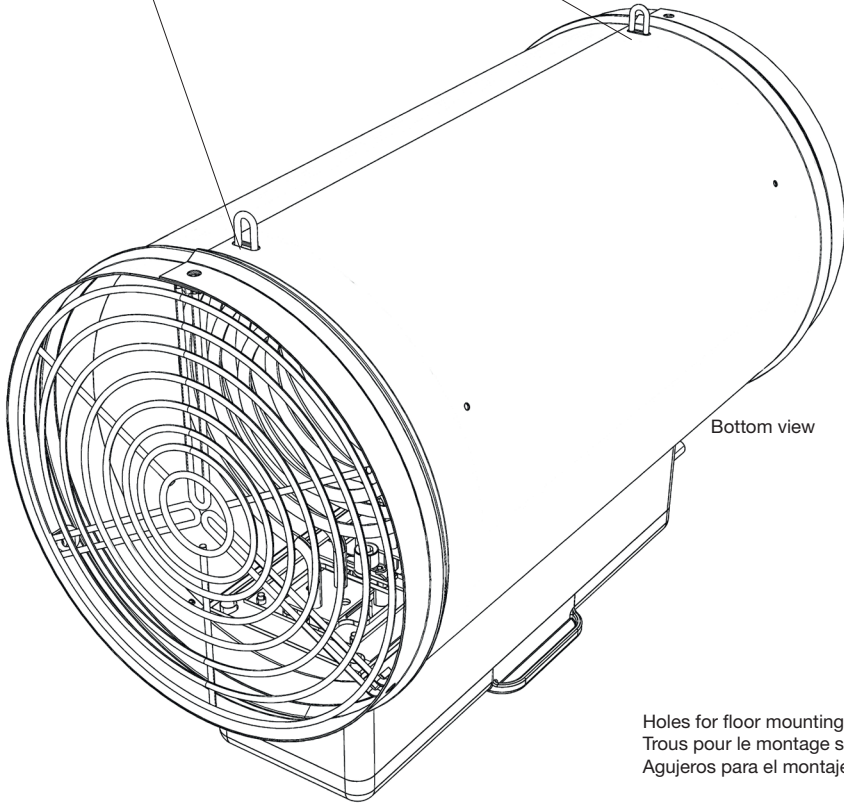

Bottom view

Holes for floor mounting
Trous pour le montage sur le sol
Agujeros para el montaje en el piso

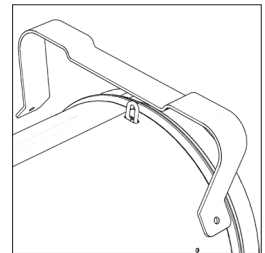
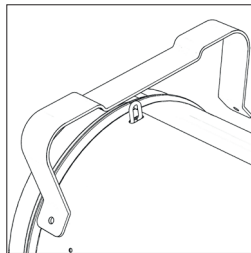

Index

US	Operating instructions	3
FR	Mode d'emploi	21
ES	Operating instructions	21

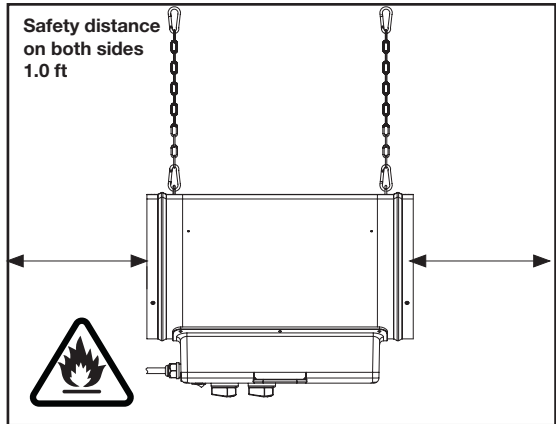
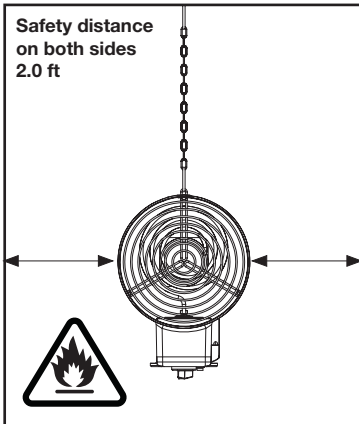

Read all instructions first before installing the Phoenix Heater!	
--	--

Do not drink any alcohol or take any drugs before or during the installation of the Phoenix Heater and follow the safety instructions carefully.	
---	--

1. Delivery Checklist

1x air circulation heater PHX 2.8/US
 2x foot
 2x chain with snap hook
 2x cropped head bolts & nuts with rings
 4x self tapping screw
 4x locking washer

2. Technical data

Apparatus type: PHX 2.8/US
 Power supply: 230 V ~ / 50-60 Hz
 Power: 1000 / 1800 / 2800 W
 Current: 13 A (max.)
 Control range: 32 – 79 °F
 Protection category: I

IMPORTANT:

Familiarise yourself with the instructions in this manual and the general safety and hazard notes before installation. Keep this document in a safe place for future reference. If you have any doubts about the safety of the apparatus, please consult a skilled person. When installing in a greenhouse, please ensure that the electrical connections are made by a qualified person.

3. General

After unpacking and before using for the first time, ensure that the apparatus and all the accessories are not damaged. In case of transport damage, please contact your distributor or the manufacturer immediately. Keep packaging material (polybags, polystyrene, nails etc.) out of reach of children, since such materials are hazardous.

The PHX 2.8/US electric air circulation heater is designed to heat greenhouses and winter gardens uniformly, also saving energy. Its defining features include simple operation and minimum installation space requirement. This apparatus is designed for connection to 230 V ~ / 50-60 Hz AC only. It must be protected against heavy soiling and moisture. Any use other than that described above may damage the apparatus and also carries risks of e.g. short circuits, fire, electric shock, etc. It is imperative that the safety and installation instructions are followed.



4. Safety and hazard notes

- Use only with a 230 V ~, 50/60 Hz mains socket with a RCCB (Residual Current Circuit Breaker protection).
- Never attempt to operate the apparatus with a different voltage.
- If you are unsure about usage, safety or connection of the apparatus, please consult an authorized specialist.
- This apparatus is for indoor use only.
- The apparatus must be unplugged from mains before opening the cover or removing components.
- Never touch the mains plug with wet hands.
- Never pull on the power cable, pull the plug only by gripping it by the surfaces provided.
- Never store or use flammable materials or spray near the apparatus. **Fire hazard!**
- Do not use the apparatus in a flammable atmosphere (e.g. close to combustion gas or spray cans). **Explosion and fire hazard!**
- Do not cover the heater. **Fire hazard!**
- Never install the apparatus near taps, basins or other sources of water. Also never connect your heater to a power supply unless its surfaces are dry.
- Do not insert objects into the openings of the apparatus. Risk of injury, electric shock or risk of damage to the appliance!
- The enclosure heats up during operation. Install the appliance in such a way so as to prevent accidental contact. **Danger of burning!**

After switching off, the appliance cools down only slowly. Carry only by the handle provided.

- Never dry flammable objects in front of the exhaust openings.

Fire hazard!

- When installing, ensure that the connecting cord is not crushed or damaged by sharp edges. If such damage should expose the wires, the appliance must under no circumstances be connected to the power supply. **Life-threatening!**
- Always disconnect from the mains before cleaning the appliance. Clean only with a damp (not wet) cloth.
- Always disconnect from the mains if the appliance will not be used any length of time. During this time, store your heater in a protected and dry place.
- If it may be assumed that the apparatus can no longer be safely operated, it must be decommissioned and protected against accidental operation.

This is the case if:

- the apparatus or mains chord are visibly damaged
 - the apparatus no longer operates
 - after extended storage in unfavourable conditions
 - after rough transport conditions
- Apparatus operated from mains voltage must be kept away from children.
 - The apparatus is not suited for use in areas used for animal husbandry.

- These operating instructions are part of the apparatus and should be kept in a safe place. If the apparatus is passed on to third parties, it must be passed on together with the operating instructions.
- In industrial facilities, the Accident Prevention regulations for electrical installations and operating materials of the industrial employer's liability insurance association are to be observed.
- Never spill fluids on the apparatus. There is a danger of fire or lethal electric shock. In such an event, unplug the mains and consult a skilled person.
- Should you be unsure about the proper connection or should any questions arise that are not dealt with in these operating instructions, please contact the manufacturer or an authorized person.
- This apparatus may not be operated by persons (including children) with limited physical, sensory
- or mental faculties, or by persons who are not sufficiently experienced or adequately
- knowledgeable in the use of the product, unless such persons are supervised or instructed in the use of the apparatus by a person responsible for their safety.

5. Installation

The electrical appliance may only be operated from earth leakage protected sockets! Before operating the apparatus, ensure that this is the case for the socket to be used.

Make sure that the maximum current is not exceeded when the outlet has more than one socket or when using extension chords. cable reels must always be fully unwound. Ensure that the air circulation heater is disconnected from mains before or during installation. Select a place for installation where the apparatus will not be exposed to rain or may fall into water.

Route the connecting cable such that it will not be a stumbling hazard, cannot be crushed or come into contact with hot objects. Use only extension leads matched to the power rating of the apparatus and complying with the applicable safety regulations. Do not wind the connecting lead around the apparatus and never operate the apparatus with a coiled lead.

Standing installation:

To use the PHX 2.8/US greenhouse heater as a floor mounted apparatus, the supplied feet must first be fitted. The following supplied components are required for assembly:

- 2 x PHOENIX feet
- 4 x self tapping screws
- 4 x serrated washers

Have a Phillips screwdriver at hand. The PHOENIX heater comes with pre-drilled holes in the housing for attaching the feet. Fasten the feet here, using the self tapping screws with serrated washers (see illustration on Page 2). Your PHOENIX air circulation heater is now ready to use as a floor-mounted apparatus.

Hanging installation:

To use the PHOENIX 2.8 air circulation heater as a hanging apparatus, the supplied chains must first be fitted. The following supplied components are required for assembly:

- 2 x PHOENIX hanging chains
- 2 x V-hooks

The PHOENIX heater comes with metal lugs on the housing to hook the chains, using the snap hooks. The other two snap hooks then hook into the V-hooks. These V-hooks are then fastened to the profiles in your greenhouse (see illustration on Page 2). Your PHOENIX greenhouse heater is now ready to use as a hanging heater.

6. Operation

Connect the heating apparatus to any 230 V ~ 50/60 Hz AC socket. The PHOENIX air circulation heater has two selector switches and a thermostat. Using the selector switches, you may select one of the 8 possible operating modes. Set the desired greenhouse temperature on the thermostat (control range 0-26 °C). An integral lamp signals heating operation.

Thermostat:







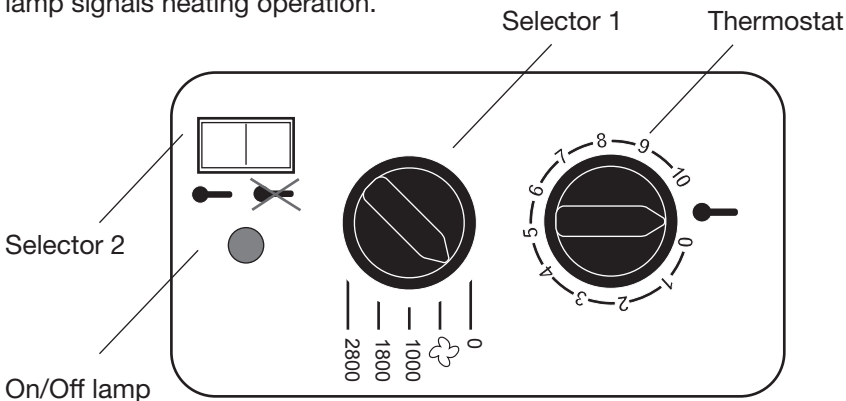



The thermostat is linear and infinitely variable from 0 - 26 °C. The printed figures from 0-10 on the adjustment wheel are for general orientation to the temperature range being selected. This means that the increasing numbers each mean a rise in temperature of approx. 2.6 °C (see example below). Example.: Number Temperature range

0 - 1 ≈ 32 - 37 °F	0 - 2.6 °C
1 - 2 ≈ 37 - 42 °F	2.6 - 5.2 °C
2 - 3 ≈ 42 - 46 °F	5.2 - 7.8 °C
3 - 4 ≈ 46 - 51 °F	7.8 - 10.4 °C
etc.	

Refer to page 9 in the section 'winter operation' to find out how to set the temperature exactly.



Selector switch:

Item	Selector switch 1	Selector switch 2	Function
1	0	 	Appliance not in operation
2a			Circulating air without heating (circulating air controlled by thermostat)
2b			Circulating air without heating (circulating air in constant operation)
3a	1000		1000 W heating performance with circulating air (heating and circulating air controlled by thermostat)
3b			1000 W heating performance with circulating air (heating controlled by thermostat, circulating air in constant operation)
4a	1800		1800 W heating performance with circulating air (heating and circulating air controlled by thermostat)
4b			1800 W heating performance with circulating air (heating controlled by thermostat, circulating air in constant operation)
5a	2800		2800 W heating performance with circulating air (heating and circulating air controlled by thermostat)
5b			2800 W heating performance with circulating air (heating controlled by thermostat, circulating air in constant operation)

Winter operation:

Step 1: Select the desired operating mode on selector switches 1 and 2. Depending on the size and location of the greenhouse we recommend selecting a heating performance of 2800 watts or 1800 watts in the winter months. On the other hand, the lower performance of 1000 watts is often sufficient in the transition periods (autumn and spring).

1800 watts: Ideal frost protection up to a greenhouse size of approximately 12 m². 2800 watts: Ideal frost protection up to a greenhouse size of approximately 20 m².

Note: If you have sensitive plants in your greenhouse over the winter (e.g. cacti) that cannot tolerate fluctuating temperatures then we recommend

heating in operating modes 3b, 4b or 5b. These operating modes give you continual air circulation and do not produce large temperature gradients between upper and lower layers of air. The same is also true for greenhouses with very high humidity. The continual circulation of air prevents the occurrence of mould and fungi.

If you have robust plants and merely wish to prevent frost you can use operating modes 3a, 4a or 5a. Please consult a gardener if you have questions in this regard.

Step 2: Select the desired temperature range on the thermostat adjustment wheel. Refer to the example on page 8 to see which position on the thermostat corresponds to the desired temperature and then set it accordingly. Now leave the heating to operate for several hours and monitor the room temperature with the help of a thermometer (MIN-MAX thermometer recommended). Then correct the setting slightly upwards or downwards if necessary if the desired temperature is not maintained. This setting process only needs to be carried out once during initial operation. The heating system will keep the temperature constant once the correct setting has been discovered.

Note: It is unfortunately not possible to print the temperature scale on the adjustment wheel of the thermometer as it reacts differently depending on size, insulation, stocking and location of each greenhouse.

Recommendation:

If you would like to keep valuable plants in your greenhouse over the winter then we recommend installing a second heat source that is activated if this heating fails (e.g. during a power cut). This protects your plants from freezing.

Summer operation:

In the summer months you can use the air circulation mode to achieve substantial cooling of the greenhouse temperature. Select operating mode 2b for this purpose and open the door or roof windows in your greenhouse. The position of the thermostat adjustment wheel is irrelevant in this case. The greenhouse air that is heated by the sun is continually circulated in circulation mode and is transported outside. This measure also regulates humidity in the greenhouse and promotes pollination of your plants.

Note: Never use operating mode 2a for summer operation. As the air circulation is regulated by the thermostat in this mode it would switch off the fan after a short period of strong sun exposure. This would mean that the air circulation and the associated cooling would no longer be assured.

Safety feature

Temperature-controlled switch-off: The apparatus will automatically switch off temporarily if it should over-heat. To restart, switch off the heater for 5 to 10 minutes to cool down. Another reason for automatic switch-off may be blockages in the air inlet or exhaust apertures. In this case, please remove the obstructing objects. It may, however, also be an indication that the fan has failed. In this case, switch off the heating apparatus, unplug it and call on an authorised technician for repairs.

7. Cleaning, repairs and disposal

- Do not use abrasive or caustic cleaning agents.
- Before cleaning, switch off the apparatus and allow it to cool down for about 30 min. before starting with cleaning.
- Clean the enclosure with a damp cloth (not wet), vacuum cleaner or feather duster.
- Never submerge the apparatus in water.
- Take the material to be disposed of to an appropriate waste disposal point.
- The apparatus may only be repaired by authorised persons. Please contact the manufacturer or distributor in this regard.
- Attention! The guarantee is null and void in the case of improper repairs.
- Flawed repairs pose a danger to the user and other persons.

8. MANUFACTURER'S REPRESENTATIONS AND WARRANTIES

Bio Green GmbH & Co. KG
Marburger Str. 1b
35649 Bischoffe-Oberweidbach
Phone: +49 64 44 / 93 12 0
Fax: +49 6444 / 6162
Email: info@biogreen.de
Web: www.biogreen.world

These Representations and Warranties are applicable to all customers (the "Customers" and each, individually, a "Customer") purchasing products (the "Products") manufactured by Bio Green GmbH & Co. KG (the "Company").

1. Warranty and Limitations:

1.1. Company warrants solely to the original purchaser of the Products that for the Warranty Period (as defined below), the Products will be free from defects in materials and workmanship under normal use, and will conform to Company's published specifications of the Products. Notwithstanding the foregoing, Company retains its right to deviate from its published specifications due to the latest innovations and improvements in function and design of the Products.

1.2. The foregoing warranty is subject to the proper storage, transportation and use of the Products, and does not include defects due to normal wear and tear or deterioration.

1.3. Customer shall immediately, but in any event no later than eight (8) days following delivery of the Product, inspect the Products for conformity and visible defects. Customer shall give Company immediate written notice of any non-conformities or visible defects regarding the Products. In the event that Customer fails to provide the Company within eight (8) days following delivery of the Products with notice of any non-conformities or visible defects, any warranty claims in this regard shall be deemed waived.

1.4. Customer shall immediately notify Company in writing of any other defects of the Products and return such defective Product. Prior to any shipment of a defective Product, Customer shall contact Company first at the address provided in 1.9. Company's sole obligation under the foregoing warranty is, at Company's option and in its sole discretion, to repair, replace or exchange the defective Product. Any repaired, replaced or exchanged Products shall be subject to this warranty, following their repair, replacement or exchange. If Company has received notification from Customer, and no defects of the Product could be discovered, Customer shall bear the costs that Company incurred as a result of the notice. It shall be in Company's sole discretion to determine if the Product has a defect. In no event shall Company bear the costs of disassembly.

1.5. With respect to orders made to custom, any defects of the Products caused by Customer's specifications are excluded from the warranty set forth in 1.1.

1.6. Company also makes no warranty that the Products manufactured under an order made to custom do not infringe the intellectual property or other proprietary rights of any third party and Customer is solely responsible for assuring that such Products do not so infringe.

1.7. The "Warranty Period" begins on the date of delivery of the Product to Customer, and continues to be in effect for twenty-four (24) months. The "Warranty Period" shall be suspended for the time of repair, replacement or exchange until the repaired, exchanged or replaced product has been returned to Customer.

1.8. Company does not authorize any person or party to assume or create for it any other obligation or liability in connection with the Products except as set forth herein.

1.9. All requests and notices under this Warranty shall be directed to:

CTL /Co. Bio Green USA Inc.
2881 Busse Road
Elk Grove Village, IL 60007
United States
Tel. 1-800-941-3169
info@biogreen-products.com

1.10. THE WARRANTY SET FORTH IN SECTION 1.1 IS MADE IN LIEU OF ALL OTHER WARRANTIES (WHETHER EXPRESS OR IMPLIED), RIGHTS OR CONDITIONS, AND CUSTOMER ACKNOWLEDGES THAT EXCEPT FOR SUCH LIMITED WARRANTY, THE PRODUCTS ARE PROVIDED "AS IS." COMPANY SPECIFICALLY DISCLAIMS, WITHOUT LIMITATION, ALL OTHER WARRANTIES, EXPRESS OR IMPLIED, OF ANY KIND, INCLUDING, WITHOUT LIMITATION, THE IMPLIED WARRANTIES OF MERCHANTABILITY AND FITNESS FOR A PARTICULAR PURPOSE, NON-INFRINGEMENT, AND THOSE WARRANTIES ARISING FROM A COURSE OF PERFORMANCE, A COURSE OF DEALING OR TRADE USAGE.

2. Limitation of Liability:

2.1. IN NO EVENT SHALL COMPANY BE LIABLE FOR ANY INDIRECT, INCIDENTAL, PUNITIVE, SPECIAL OR CONSEQUENTIAL DAMAGES, INCLUDING BUT NOT LIMITED TO, DAMAGES FOR LOSS OF PROFITS, REVENUE, GOODWILL OR USE, INCURRED BY CUSTOMER OR ANY THIRD PARTY, WHETHER IN AN ACTION IN CONTRACT, TORT, STRICT LIABILITY, OR IMPOSED BY STATUTE, OR OTHERWISE, EVEN IF ADVISED OF THE POSSIBILITY OF SUCH DAMAGES. COMPANY'S LIABILITY

FOR DAMAGES ARISING OUT OF OR IN CONNECTION WITH THIS AGREEMENT SHALL IN NO EVENT EXCEED THE PURCHASE PRICE OF THE PRODUCTS. IT IS AGREED AND ACKNOWLEDGED THAT THE PROVISIONS OF THIS AGREEMENT ALLOCATE THE RISKS BETWEEN COMPANY AND CUSTOMER, THAT COMPANY'S PRICING REFLECTS THIS ALLOCATION OF RISK, AND BUT FOR THIS ALLOCATION AND LIMITATION OF LIABILITY, COMPANY WOULD NOT HAVE ENTERED INTO THIS AGREEMENT.

2.2. IN JURISDICTIONS THAT LIMIT THE SCOPE OF OR PRECLUDE LIMITATIONS OR EXCLUSION OF REMEDIES OR DAMAGES, OR OF LIABILITY, SUCH AS LIABILITY FOR GROSS NEGLIGENCE OR WILLFUL MISCONDUCT OR DO NOT ALLOW IMPLIED WARRANTIES TO BE EXCLUDED, THE LIMITATION OR EXCLUSION OF WARRANTIES, REMEDIES, DAMAGES OR LIABILITY SET FORTH ABOVE ARE INTENDED TO APPLY TO THE MAXIMUM EXTENT PERMITTED BY APPLICABLE LAW. CUSTOMER MAY ALSO HAVE OTHER RIGHTS THAT VARY BY STATE, COUNTRY OR OTHER JURISDICTION.

1. Matériel fourni

1x chauffage à circulation d'air PHX 2.8

2x pieds

2x chaînes avec mousquetons

2x vis à tête rectangulaire (rondelles)

4x tôles à vis

4x rondelles à dents chevauchantes

2. Données techniques

Type d'appareil :

Alimentation électrique : PHX 2.8/US

Puissance : 230 V ~ / 50-60 Hz

Consommation de courant : 1000 / 1800 / 2800 W

Plage de réglage : 13 A (max.)

Classe de protection : 32 – 79 °F

IMPORTANT:

Lisez les indications données dans ce mode d'emploi ainsi que les consignes de sécurité et de danger générales avant de procéder à l'installation et tenez-en compte. Conservez soigneusement ce mode d'emploi afin de pouvoir le consulter ultérieurement. Si vous avez des doutes concernant la sécurité de l'appareil, demandez conseil à un spécialiste. Si vous placez l'appareil dans une serre, assurez-vous que les raccordements électriques ont été effectués par du personnel qualifié.

3. Généralités

Après déballage et avant mise en service, assurez-vous que l'appareil et tous ses accessoires ne présentent aucun dommage. Si vous constatez des dommages dus au transport, consultez immédiatement le vendeur ou fabricant. Les matériaux d'emballage (sachets en plastique,

polystyrène, clous, etc.) ne peuvent pas être laissés à portée de main des enfants car ils représentent une source de danger potentielle. Le chauffage à circulation d'air électrique PHX 2.8 sert au chauffage uniforme et peu énergivore des serres et jardins d'hiver. Il se caractérise par une utilisation simple et son installation gain de place. Cet appareil peut uniquement être raccordé au courant alternatif 230 V~/50-60 Hz. Protégez-le des fortes salissures et de l'humidité. Une utilisation autre que celle décrite précédemment peut endommager l'appareil et engendrer des dangers comme par exemple un court-circuit, un incendie, une électrocution, etc. Les consignes de sécurité et d'installation doivent impérativement être respectées.



4. Consignes de sécurité et de danger

- Use only with a 230 V ~, 50/60 Hz mains socket with a RCCB (Residual Current Circuit Braker protection).
- Never attempt to operate the apparatus with a different voltage.
- If you are unsure about usage, safety or connection of the apparatus, please consult an authorized specialist.
- This apparatus is for indoor use only.
- The apparatus must be unplugged from mains before opening the cover or removing components.
- Never touch the mains plug with wet hands.
- Never pull on the power cable, pull the plug only by gripping it by the surfaces provided.
- Never store or use flammable materials or spray near the apparatus. **Fire hazard!**
- Do not use the apparatus in a flammable atmosphere (e.g. close to combustion gas or spray cans). **Explosion and fire hazard!**
- Do not cover the heater. **Fire hazard!**
- Never install the apparatus near taps, basins or other sources of water. Also never connect your heater to a power supply unless its surfaces are dry.
- Do not insert objects into the openings of the apparatus. Risk of injury, electric shock or risk of damage to the appliance!
- The enclosure heats up during operation. Install the appliance in such a way so as to prevent accidental contact. **Danger of burning!**

After switching off, the appliance cools down only slowly. Carry only by the handle provided.

- Never dry flammable objects in front of the exhaust openings. **Fire hazard!**
- When installing, ensure that the connecting cord is not crushed or damaged by sharp edges. If such damage should expose the wires, the appliance must under no circumstances be connected to the power supply. **Life-threatening!**
- Always disconnect from the mains before cleaning the appliance. Clean only with a damp (not wet) cloth.
- Always disconnect from the mains if the appliance will not be used any length of time. During this time, store your heater in a protected and dry place.
- If it may be assumed that the apparatus can no longer be safely operated, it must be decommissioned and protected against accidental operation.
This is the case if:
 - the apparatus or mains chord are visibly damaged
 - the apparatus no longer operates
 - after extended storage in unfavourable conditions
 - after rough transport conditions
- Apparatus operated from mains voltage must be kept away from children.
- The apparatus is not suited for use in areas used for animal husbandry.

- These operating instructions are part of the apparatus and should be kept in a safe place. If the apparatus is passed on to third parties, it must be passed on together with the operating instructions.
- In industrial facilities, the Accident Prevention regulations for electrical installations and operating materials of the industrial employer's liability insurance association are to be observed.
- Never spill fluids on the apparatus. There is a danger of fire or lethal electric shock. In such an event, unplug the mains and consult a skilled person.
- Should you be unsure about the proper connection or should any questions arise that are not dealt with in these operating instructions, please contact the manufacturer or an authorized person.
- This apparatus may not be operated by persons (including children) with limited physical, sensory
- or mental faculties, or by persons who are not sufficiently experienced or adequately
- knowledgeable in the use of the product, unless such persons are supervised or instructed in the use of the apparatus by a person responsible for their safety.

5. Installation

The electrical appliance may only be operated from earth leakage protected sockets! Before operating the apparatus, ensure that this is the case for the socket to be used.

Make sure that the maximum current is not exceeded when the outlet has more than one socket or when using extension chords. cable reels must always be fully unwound. Ensure that the air circulation heater is disconnected from mains before or during installation. Select a place for installation where the apparatus will not be exposed to rain or may fall into water.

Route the connecting cable such that it will not be a stumbling hazard, cannot be crushed or come into contact with hot objects. Use only extension leads matched to the power rating of the apparatus and complying with the applicable safety regulations. Do not wind the connecting lead around the apparatus and never operate the apparatus with a coiled lead.

Standing installation:

To use the PHX 2.8/US greenhouse heater as a floor mounted apparatus, the supplied feet must first be fitted. The following supplied components are required for assembly:

- 2 x PHOENIX feet
- 4 x self tapping screws
- 4 x serrated washers

Have a Phillips screwdriver at hand. The PHOENIX heater comes with pre-drilled holes in the housing for attaching the feet. Fasten the feet here, using the self tapping screws with serrated washers (see illustration on Page 2). Your PHOENIX air circulation heater is now ready to use as a floor-mounted apparatus.

Hanging installation:

To use the PHOENIX 2.8 air circulation heater as a hanging apparatus, the supplied chains must first be fitted. The following supplied components are required for assembly:

- 2 x PHOENIX hanging chains
- 2 x V-hooks

The PHOENIX heater comes with metal lugs on the housing to hook the chains, using the snap hooks. The other two snap hooks then hook into the V-hooks. These V-hooks are then fastened to the profiles in your greenhouse (see illustration on Page 2). Your PHOENIX greenhouse heater is now ready to use as a hanging heater.

6. Operation

Connect the heating apparatus to any 230 V ~ 50/60 Hz AC socket. The PHOENIX air circulation heater has two selector switches and a thermostat. Using the selector switches, you may select one of the 8 possible operating modes. Set the desired greenhouse temperature on the thermostat (control range 0-26 °C). An integral lamp signals heating operation.

Thermostat:







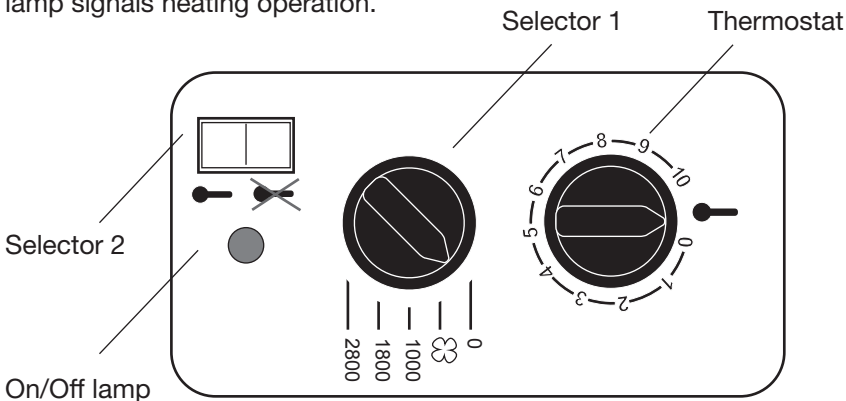



The thermostat is linear and infinitely variable from 0 - 26 °C. The printed figures from 0-10 on the adjustment wheel are for general orientation to the temperature range being selected. This means that the increasing numbers each mean a rise in temperature of approx. 2.6 °C (see example below). Example.: Number Temperature range

0 - 1 ≈ 32 - 37 °F	0 - 2.6 °C
1 - 2 ≈ 37 - 42 °F	2.6 - 5.2 °C
2 - 3 ≈ 42 - 46 °F	5.2 - 7.8 °C
3 - 4 ≈ 46 - 51 °F	7.8 - 10.4 °C
etc.	

Refer to page 9 in the section 'winter operation' to find out how to set the temperature exactly.



Selector switch:

Item	Selector switch 1	Selector switch 2	Function
1	0	 	Appliance not in operation
2a			Circulating air without heating (circulating air controlled by thermostat)
2b			Circulating air without heating (circulating air in constant operation)
3a	1000		1000 W heating performance with circulating air (heating and circulating air controlled by thermostat)
3b			1000 W heating performance with circulating air (heating controlled by thermostat, circulating air in constant operation)
4a	1800		1800 W heating performance with circulating air (heating and circulating air controlled by thermostat)
4b			1800 W heating performance with circulating air (heating controlled by thermostat, circulating air in constant operation)
5a	2800		2800 W heating performance with circulating air (heating and circulating air controlled by thermostat)
5b			2800 W heating performance with circulating air (heating controlled by thermostat, circulating air in constant operation)

Winter operation:

Step 1: Select the desired operating mode on selector switches 1 and 2. Depending on the size and location of the greenhouse we recommend selecting a heating performance of 2800 watts or 1800 watts in the winter months. On the other hand, the lower performance of 1000 watts is often sufficient in the transition periods (autumn and spring).

1800 watts: Ideal frost protection up to a greenhouse size of approximately 12 m². 2800 watts: Ideal frost protection up to a greenhouse size of approximately 20 m².

Note: If you have sensitive plants in your greenhouse over the winter (e.g. cacti) that cannot tolerate fluctuating temperatures then we recommend

heating in operating modes 3b, 4b or 5b. These operating modes give you continual air circulation and do not produce large temperature gradients between upper and lower layers of air. The same is also true for greenhouses with very high humidity. The continual circulation of air prevents the occurrence of mould and fungi.

If you have robust plants and merely wish to prevent frost you can use operating modes 3a, 4a or 5a. Please consult a gardener if you have questions in this regard.

Step 2: Select the desired temperature range on the thermostat adjustment wheel. Refer to the example on page 8 to see which position on the thermostat corresponds to the desired temperature and then set it accordingly. Now leave the heating to operate for several hours and monitor the room temperature with the help of a thermometer (MIN-MAX thermometer recommended). Then correct the setting slightly upwards or downwards if necessary if the desired temperature is not maintained. This setting process only needs to be carried out once during initial operation. The heating system will keep the temperature constant once the correct setting has been discovered.

Note: It is unfortunately not possible to print the temperature scale on the adjustment wheel of the thermometer as it reacts differently depending on size, insulation, stocking and location of each greenhouse.

Recommendation:

If you would like to keep valuable plants in your greenhouse over the winter then we recommend installing a second heat source that is activated if this heating fails (e.g. during a power cut). This protects your plants from freezing.

Summer operation:

In the summer months you can use the air circulation mode to achieve substantial cooling of the greenhouse temperature. Select operating mode 2b for this purpose and open the door or roof windows in your greenhouse. The position of the thermostat adjustment wheel is irrelevant in this case. The greenhouse air that is heated by the sun is continually circulated in circulation mode and is transported outside. This measure also regulates humidity in the greenhouse and promotes pollination of your plants.

Note: Never use operating mode 2a for summer operation. As the air circulation is regulated by the thermostat in this mode it would switch off the fan after a short period of strong sun exposure. This would mean that the air circulation and the associated cooling would no longer be assured.

Safety feature

Temperature-controlled switch-off: The apparatus will automatically switch off temporarily if it should over-heat. To restart, switch off the heater for 5 to 10 minutes to cool down. Another reason for automatic switch-off may be blockages in the air inlet or exhaust apertures. In this case, please remove the obstructing objects. It may, however, also be an indication that the fan has failed. In this case, switch off the heating apparatus, unplug it and call on an authorised technician for repairs.

7. Cleaning, repairs and disposal

- Do not use abrasive or caustic cleaning agents.
- Before cleaning, switch off the apparatus and allow it to cool down for about 30 min. before starting with cleaning.
- Clean the enclosure with a damp cloth (not wet), vacuum cleaner or feather duster.
- Never submerge the apparatus in water.
- Take the material to be disposed of to an appropriate waste disposal point.
- The apparatus may only be repaired by authorised persons. Please contact the manufacturer or distributor in this regard.
- Attention! The guarantee is null and void in the case of improper repairs.
- Flawed repairs pose a danger to the user and other persons.

8. MANUFACTURER'S REPRESENTATIONS AND WARRANTIES

Bio Green GmbH & Co. KG
Marburger Str. 1b
35649 Bischoffe-Oberweidbach
Phone: +49 64 44 / 93 12 0
Fax: +49 6444 / 6162
Email: info@biogreen.de
Web: www.biogreen.world

These Representations and Warranties are applicable to all customers (the "Customers" and each, individually, a "Customer") purchasing products (the "Products") manufactured by Bio Green GmbH & Co. KG (the "Company").

1. Warranty and Limitations:

1.1. Company warrants solely to the original purchaser of the Products that for the Warranty Period (as defined below), the Products will be free from defects in materials and workmanship under normal use, and will conform to Company's published specifications of the Products. Notwithstanding the foregoing, Company retains its right to deviate from its published specifications due to the latest innovations and improvements in function and design of the Products.

1.2. The foregoing warranty is subject to the proper storage, transportation and use of the Products, and does not include defects due to normal wear and tear or deterioration.

1.3. Customer shall immediately, but in any event no later than eight (8) days following delivery of the Product, inspect the Products for conformity and visible defects. Customer shall give Company immediate written notice of any non-conformities or visible defects regarding the Products. In the event that Customer fails to provide the Company within eight (8) days following delivery of the Products with notice of any non-conformities or visible defects, any warranty claims in this regard shall be deemed waived.

1.4. Customer shall immediately notify Company in writing of any other defects of the Products and return such defective Product. Prior to any shipment of a defective Product, Customer shall contact Company first at the address provided in 1.9. Company's sole obligation under the foregoing warranty is, at Company's option and in its sole discretion, to repair, replace or exchange the defective Product. Any repaired, replaced or exchanged Products shall be subject to this warranty, following their repair, replacement or exchange. If Company has received notification from Customer, and no defects of the Product could be discovered, Customer shall bear the costs that Company incurred as a result of the notice. It shall be in Company's sole discretion to determine if the Product has a defect. In no event shall Company bear the costs of disassembly.

1.5. With respect to orders made to custom, any defects of the Products caused by Customer's specifications are excluded from the warranty set forth in 1.1.

1.6. Company also makes no warranty that the Products manufactured under an order made to custom do not infringe the intellectual property or other proprietary rights of any third party and Customer is solely responsible for assuring that such Products do not so infringe.

1.7. The "Warranty Period" begins on the date of delivery of the Product to Customer, and continues to be in effect for twenty-four (24) months. The "Warranty Period" shall be suspended for the time of repair, replacement or exchange until the repaired, exchanged or replaced product has been returned to Customer.

1.8. Company does not authorize any person or party to assume or create for it any other obligation or liability in connection with the Products except as set forth herein.

1.9. All requests and notices under this Warranty shall be directed to:

CTL /Co. Bio Green USA Inc.
2881 Busse Road
Elk Grove Village, IL 60007
United States
Tel. 1-800-941-3169
info@biogreen-products.com

1.10. THE WARRANTY SET FORTH IN SECTION 1.1 IS MADE IN LIEU OF ALL OTHER WARRANTIES (WHETHER EXPRESS OR IMPLIED), RIGHTS OR CONDITIONS, AND CUSTOMER ACKNOWLEDGES THAT EXCEPT FOR SUCH LIMITED WARRANTY, THE PRODUCTS ARE PROVIDED "AS IS." COMPANY SPECIFICALLY DISCLAIMS, WITHOUT LIMITATION, ALL OTHER WARRANTIES, EXPRESS OR IMPLIED, OF ANY KIND, INCLUDING, WITHOUT LIMITATION, THE IMPLIED WARRANTIES OF MERCHANTABILITY AND FITNESS FOR A PARTICULAR PURPOSE, NON-INFRINGEMENT, AND THOSE WARRANTIES ARISING FROM A COURSE OF PERFORMANCE, A COURSE OF DEALING OR TRADE USAGE.

2. Limitation of Liability:

2.1. IN NO EVENT SHALL COMPANY BE LIABLE FOR ANY INDIRECT, INCIDENTAL, PUNITIVE, SPECIAL OR CONSEQUENTIAL DAMAGES, INCLUDING BUT NOT LIMITED TO, DAMAGES FOR LOSS OF PROFITS, REVENUE, GOODWILL OR USE, INCURRED BY CUSTOMER OR ANY THIRD PARTY, WHETHER IN AN ACTION IN CONTRACT, TORT, STRICT LIABILITY, OR IMPOSED BY STATUTE, OR OTHERWISE, EVEN IF ADVISED OF THE POSSIBILITY OF SUCH DAMAGES. COMPANY'S LIABILITY

FOR DAMAGES ARISING OUT OF OR IN CONNECTION WITH THIS AGREEMENT SHALL IN NO EVENT EXCEED THE PURCHASE PRICE OF THE PRODUCTS. IT IS AGREED AND ACKNOWLEDGED THAT THE PROVISIONS OF THIS AGREEMENT ALLOCATE THE RISKS BETWEEN COMPANY AND CUSTOMER, THAT COMPANY'S PRICING REFLECTS THIS ALLOCATION OF RISK, AND BUT FOR THIS ALLOCATION AND LIMITATION OF LIABILITY, COMPANY WOULD NOT HAVE ENTERED INTO THIS AGREEMENT.

2.2. IN JURISDICTIONS THAT LIMIT THE SCOPE OF OR PRECLUDE LIMITATIONS OR EXCLUSION OF REMEDIES OR DAMAGES, OR OF LIABILITY, SUCH AS LIABILITY FOR GROSS NEGLIGENCE OR WILLFUL MISCONDUCT OR DO NOT ALLOW IMPLIED WARRANTIES TO BE EXCLUDED, THE LIMITATION OR EXCLUSION OF WARRANTIES, REMEDIES, DAMAGES OR LIABILITY SET FORTH ABOVE ARE INTENDED TO APPLY TO THE MAXIMUM EXTENT PERMITTED BY APPLICABLE LAW. CUSTOMER MAY ALSO HAVE OTHER RIGHTS THAT VARY BY STATE, COUNTRY OR OTHER JURISDICTION.



Bio Green USA Inc.
2881 Busse Road
Elk Grove Village, IL 60007
United States
Tel. 1-800-941-3169
info@biogreen-products.com

www.biogreen-products.com