

**DE** Montageanleitung

**NL** Montagehandleiding

**EN** Mounting instruction

**CS** Návod k instalaci

**ES** Instrucciones de instalación

**PL** Instrukcja montażu

**FR** Instructions d'installation

**RU** Инструкция по монтажу

**IT** Istruzioni per l'installazione

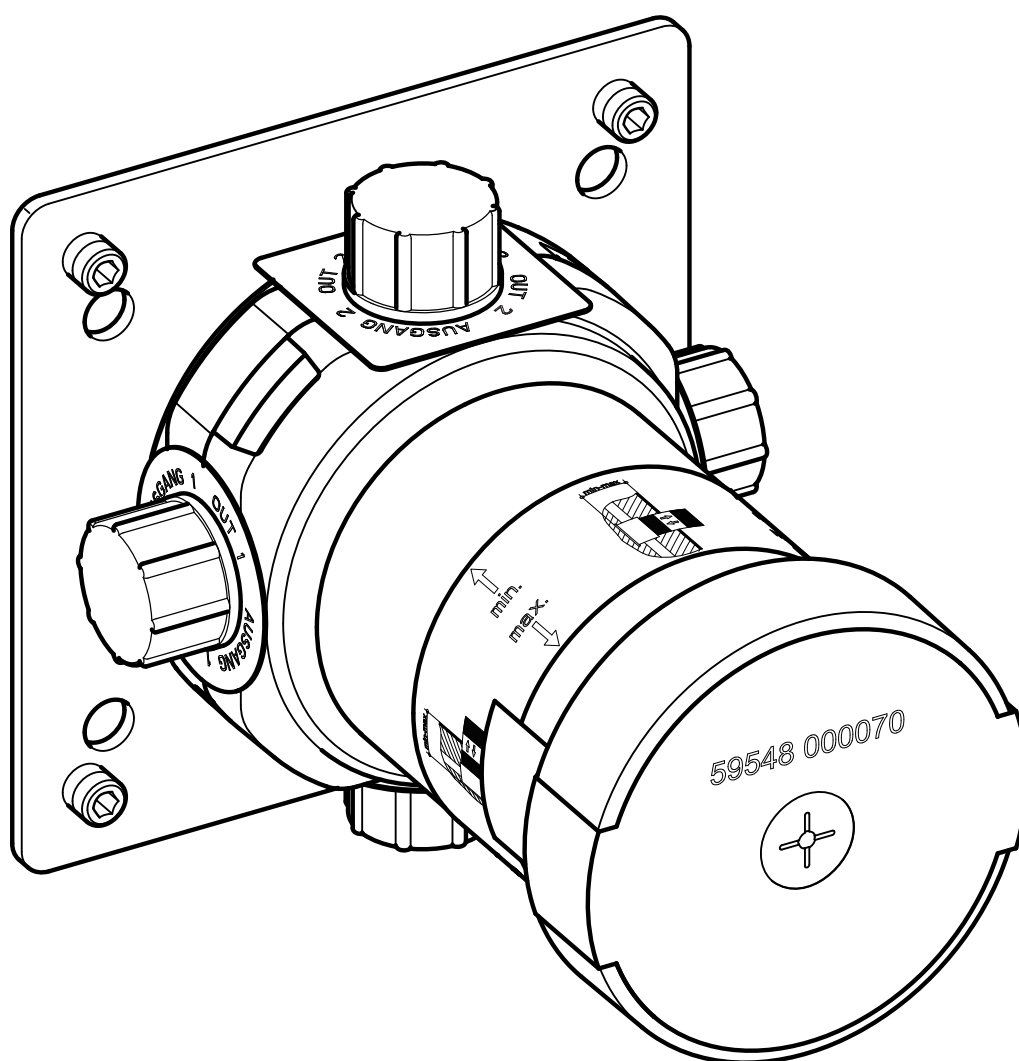

59548 000070

**DE** Einbaumaße

**FR** Dimensions de montage

**CS** Montážní rozměry

**EN** Mounting dimensions

**IT** Dimensioni di montaggio

**PL** Wymiary montażowe

**ES** Dimensiones de montaje

**NL** Montageafmetingen

**RU** Установочные размеры

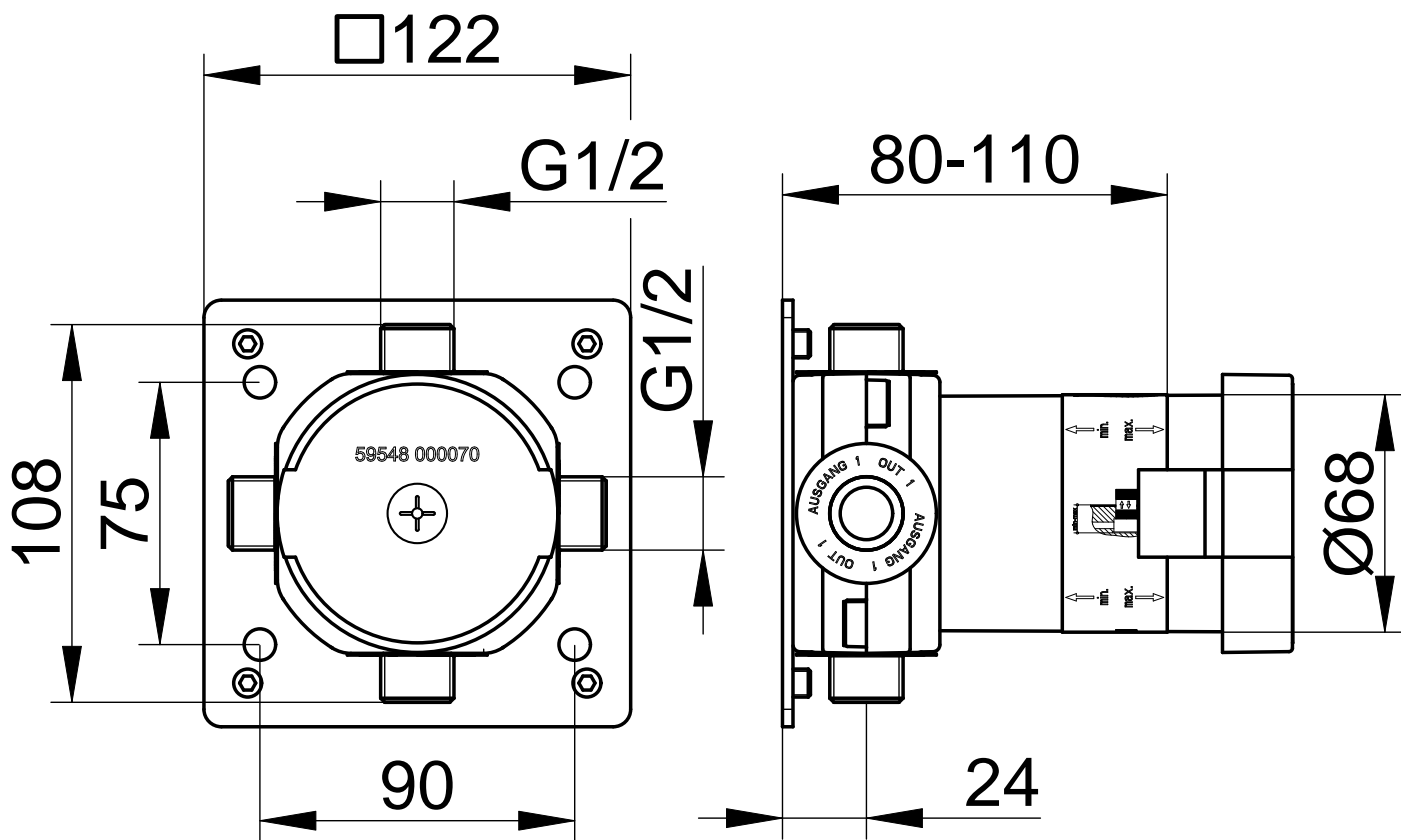

59548 000070

**Symbole und Bedeutung**





-  **Achtung!** Warnung vor Personen- oder Sachschaden.
-  **Achtung!** Warnung vor Stromschlag.
-  **Achtung!** Warnung vor Wasserschaden.
-  Hinweis, Tipp oder Verweis
-  Korrekte Montage/Funktionsprüfung
-  Falsche Montage
-  Kaltwasser
-  Warmwasser
-  Wasserfluss
-  Kein Wasserfluss
-  Optional/Zubehör

**Technische Daten**

- Durchfluss bei 3 bar Fließdruck: ca. 14 l/min
- Fließdruck: min. 0,5 bar/empfohlen 1-5 bar
- Betriebsdruck: max. 10 bar
- Prüfdruck: 16 bar
- Empfohlene Warmwassereingangstemperatur: max. 65° C
- Wasseranschluss: kalt = Kennzeichnung blau  
warm = Kennzeichnung rot











**Einbaumaße**, siehe Seite 2

**Installation**, siehe ab Bild 1 auf Seite 9

-  Trinkwasserleitungen vor und nach der Installation gründlich spülen (EN 806 und 1717 sowie DIN 1988 beachten).  
Anschlüsse mit hydraulischem Druck auf Dichtheit prüfen.
-  Betrieb nur mit Wasser in Trinkwasserqualität.
-  Produkt ausschließlich zur Montage in Innenräumen geeignet!
-  **Achtung!** Installation nur in frostfreien Räumen.

**Ersatzteile mit Bestellnummern**, siehe Seite 11.

**Symbols and explanations**





-  **Attention!** Warning against bodily injury or damage to property.
-  **Attention** Warning against electric shock.
-  **Attention!** Warning against water damage.
-  Note, tip or reference
-  Correct installation/test of functionality
-  Incorrect installation
-  Cold water
-  Hot water
-  Water flow
-  No water flow
-  Optional/accessories

**Technical specifications**

- Flow at 3 bar pressure: approx. 14 l/min
- Pressure: min. 0,5 bar/recommended 1-5 bar
- Operating pressure: max. 10 bar
- Test pressure: 16 bar
- Recommended hot water inlet temperature: max. 65° C
- Water connection: cold = blue marking  
hot = red marking











**Installation dimensions**, refer to page 2

**Installation**, refer to picture 1 on page 9

-  Flush potable water pipes thoroughly before and after installation (observe EN 806 and 1717).  
Test connections for leaks with water pressure.
-  Operation only with potable water.
-  Product is only suitable for installation indoors!
-  **Attention!** Only install in frost-free places.

**For spare parts with order numbers**, refer to page 11.

**Símbolos y significado**





-  ¡Atención! Advertencia de daños personales o materiales.
-  ¡Atención! Advertencia de descarga eléctrica.
-  ¡Atención! Advertencia de daños a causa del agua.
-  Indicación, consejo o referencia
-  Montaje/comprobación de funcionamiento correctos
-  Montaje erróneo
-  Agua fría
-  Agua caliente
-  Flujo de agua
-  Ningún flujo de agua
-  Opcional/Accesorios

**Datos técnicos**

- Paso con una presión de caudal de 3 bares:  
aprox. 14 l/min.
- Presión de caudal:  
mín. 0,5 bares / recomendado 1-5 bares
- Presión de servicio: máx. 10 bares
- Presión de comprobación: 16 bares
- Temperatura de entrada de agua  
recomendada: máx. 65° C
- Conexión de agua:  
fría = identificación azul  
caliente = identificación roja











**Medidas de montaje, véase página 2**

**Instalación, véase imagen 1 en la página 9**

-  Lavar minuciosamente las tuberías de agua potable antes y después de la instalación (observar EN 806 y 1717).  
Comprobar la estanqueidad de las conexiones con presión hidráulica.
-  Funcionamiento sólo con agua en calidad de agua potable.
-  ¡Producto adecuado exclusivamente para el montaje en interiores!
-  ¡Atención! Instalación exclusivamente en espacios sin riesgo de heladas.

**Piezas de recambio con números de pedido, véase página 11.**

**Symboles et leur signification**





-  **Attention !** Mise en garde contre les dégâts de personnes et les dégâts matériels.
-  **Attention !** Mise en garde contre les chocs électriques.
-  **Attention !** Mise en garde contre les endommagements par l'eau.
-  Remarque, conseil ou renvoi
-  Montage correct/contrôle fonctionnel
-  Montage incorrect
-  Eau froide
-  Eau chaude
-  Débit d'eau
-  Pas de débit d'eau
-  Option/accessoires

**Caractéristiques techniques**

- Débit à une pression d'écoulement de 3 bar :  
env. 14 l/mn
- Pression d'écoulement :  
min. 0,5 bar/pression conseillée 1-5 bar
- Pression de service : máx. 10 bar
- Pression de contrôle : 16 bar
- Température d'entrée d'eau chaude conseillée :  
max. 65° C
- Raccordement d'eau :  
froide = identification en bleu  
chaude = identification en rouge

**Cotes d'encombrement, voir page 2**

**Installation, voir figure 1 à la page 9**

-  Rincer soigneusement les conduites d'eau potable avant et après l'installation (respecter les normes EN 806 et 1717).  
Vérifier l'étanchéité des raccords à la pression hydraulique.
-  Utilisation seulement avec eau de qualité eau potable.
-  Le produit ne convient que pour un montage à l'intérieur !
-  **Attention !** Installation uniquement dans des pièces à l'abri du gel.

**Pièces de rechange avec numéros de commande, voir page 11.**

**Simboli e significato**





-  **Attenzione!** Pericolo di lesioni o danni materiali.
-  **Attenzione!** Pericolo di folgorazione.
-  **Attenzione!** Pericolo di danni causati dall'acqua.
-  Avvertenza, consiglio o rimando
-  Montaggio corretto/verifica del funzionamento
-  Montaggio errato
-  Acqua fredda
-  Acqua calda
-  Flusso d'acqua
-  Nessun flusso d'acqua
-  Opzionale/accessorio

**Dati tecnici**

- Portata con pressione di flusso di 3 bar:  
circa 14 l/min
- Pressione di flusso:  
min. 0,5 bar/raccomandati 1-5 bar
- Pressione di esercizio: max. 10 bar
- Pressione di prova: 16 bar
- Temperatura d'ingresso dell'acqua calda consigliata: max. 65°C
- Collegamento dell'acqua:  
fredda = marcatura blu  
calda = marcatura rossa

**Ingombro**, vedi pagina 2

**Installazione**, vedi dalla figura 1 a pagina 9

-  Prima e dopo l'installazione lavare con acqua abbondante le condotte di acqua potabile (osservare EN 806 e 1717).  
Verificare la tenuta degli attacchi con pressione idraulica.
-  Funzionamento solo con acqua potabile.
-  Prodotto adatto esclusivamente per il montaggio in ambienti interni!
-  **Attenzione!** Installazione solo in ambienti in assenza di gelo.

**Ricambi con numero d'ordine**, vedi pagina 11.

**Symbolen en betekenis**





-  **Opgepast!** Gevaar voor letsel of schade.
-  **Opgepast!** Gevaar voor elektrische schok.
-  **Opgepast!** Gevaar voor waterschade.
-  Opmerking, tip of referentie
-  Correcte montage/werkingstest
-  Verkeerde montage
-  Koud water
-  Heet water
-  Waterstroom
-  Geen waterstroom
-  Optioneel/toebehoren

**Technische gegevens**

- Doorstroming bij 3 bar stromingsdruk:  
ca. 14 l/min
- Stromingsdruk: min. 0,5 bar/aanbevolen 1-5 bar
- Bedrijfsdruk: max. 10 bar
- Testdruk: 16 bar
- Aanbevolen ingangstemperatuur heet water  
max. 65° C
- Wateraansluiting:  
koud = markering blauw  
heet = markering rood











**Inbouwafmetingen**, zie pagina 2

**Installatie**, zie vanaf afbeelding 1 op pagina 9

-  Drinkwaterleidingen voor en na de installatie grondig spoelen (volgens EN 806 en 1717).  
Aansluitingen met hydraulische druk controleren op lektheid.
-  Gebruik uitsluitend met water van drinkwaterkwaliteit.
-  Het product mag alleen binnenshuis worden gemonteerd!
-  **Opgepast!** Installatie alleen in vorstvrije ruimten.

**Wisselstukken met bestelnummers**, zie pagina 11.

**Symbole a význam**





-  **Pozor!** Výstraha před zraněním a věcnými škodami.
-  **Pozor!** Výstraha před úrazem elektrickým proudem.
-  **Pozor!** Výstraha před poškozením vodou.
-  Upozornění, tip nebo odkaz
-  Správná montáž / kontrola funkčnosti
-  Nesprávná montáž
-  Studená voda       Teplá voda
-  Průtok vody       Žádný průtok vody
-  Volitelná výbava / příslušenství

**Technické údaje**

- Průtok při průtokovém tlaku 3 bary: cca. 14 l/min
- Průtokový tlak: min. 0,5 bar/doporučeno 1-5 bar
- Provozní tlak: max. 10 bar
- Zkušební tlak: 16 bar
- Doporučená teplota vstupní teplé vody: max. 65° C
- Přípojka vody:  
 studená = označená modrou barvou  
 teplá = označená červenou barvou

**Montážní rozměry** viz strana 2

**Instalace** viz obrázek 1 na straně 9

-  Potrubí na pitnou vodu před a po instalaci důkladně vypláchněte (postupujte podle EN 806 a 1717).  
Těsnost přípojek zkontrolujte hydraulickým tlakem.
-  Provoz pouze s pitnou vodou.
-  Výrobek je vhodný výhradně k montáži ve vnitřních prostorách!
-  **Pozor!** Instalace v prostorách, které nepromrzají.

**Náhradní díly s objednáacími čísly** viz strany 11.

**Symbole i znaczenie**





-  **Uwaga!** Ostrzeżenie przed szkodami osobowymi i materialnymi.
-  **Uwaga!** Ostrzeżenie przed porażeniem prądem elektrycznym.
-  **Uwaga!** Ostrzeżenie przed szkodami, spowodowanymi przez wodę.
-  Informacja, dobra rada lub odsyłacz
-  Właściwy montaż / kontrola funkcjonowania
-  Niewłaściwy montaż
-  Woda zimna       Woda gorąca
-  Strumień wody       Brak strumienia wody
-  Opcje / Osprzęt

**Dane techniczne**

- Przepływ w przypadku ciśnienia hydraulicznego 3 bar: około 14 l/min
- Ciśnienie hydrauliczne: min. 0,5 bar/zalecane 1-5 bar
- Ciśnienie robocze: maks. 10 bar
- Ciśnienie kontrolne: 16 bar
- Zalecana temperatura wody gorącej na wejściu: maks. 65° C
- Przyłącze wody:  
 zimna = oznaczenie niebieskie  
 gorąca = oznaczenie czerwone

**Wymiary zabudowy**, patrz strona 2

**Instalacja**, patrz rys. 1 na stronie 9

-  Przed instalacją i po instalacji należy gruntownie przepłukać przewody, prowadzące wodę pitną (należy stosować się do EN 806 i 1717).  
Sprawdzić przyłącza ciśnieniem hydraulicznym w celu potwierdzenia ich szczelności.
-  Możliwa eksploatacja w instalacji wody, zapewniającej jakość typową dla wody pitnej.
-  Produkt przeznaczony jest wyłącznie do montażu wewnątrz budynków!
-  **Uwaga!** Instalacja wyłącznie w pomieszczeniach, w których temperatura nie spada poniżej zera.

**Części zamienne z numerami zamówienia**, patrz strona 11.

### Символы и их значение



**Внимание!** Опасность физического и материального ущерба.



**Внимание!** Опасность поражения электрическим током.



**Внимание!** Опасность ущерба вследствие воздействия воды.



Указание, совет или ссылка



Правильный монтаж / проверка работоспособности



Неправильный монтаж



Холодная вода



Горячая вода



Водный поток



Нет водного потока



Опция/принадлежность

### Технические характеристики

- Пропускная способность при давлении потока в 3 бар: около 14 л/мин
- Давление потока: мин. 0,5 бар/рекомендуется 1-5 бар
- Рабочее давление: макс. 10 бар.
- Расчетное давление: 16 бар.
- Рекомендуемая входная температура горячей воды: макс. 65° C
- Подключение воды:  
холодная = маркировка синим  
горячая = маркировка красным

**Монтажные размеры, см. стр. 2**

**Установка, см. рис. 1 на стр. 9**



Водопроводы питьевой воды до и после установки тщательно промыть (EN 806 и 1717).

Проверьте соединения с гидравлическим давлением на герметичность.



Использовать только воду питьевого качества.



Изделие предназначено исключительно для монтажа внутри помещения!



**Внимание!** Устанавливать только в непромерзающих помещениях.

**Запасные части с номерами для заказа, см. стр. 11.**

**DE** Kombinationen

**FR** Combinaisons

**CS** Kombinace

**EN** Combinations

**IT** Combinazioni

**PL** Kombinacje

**ES** Combinaciones

**NL** Combinaties

**RU** Комбинации

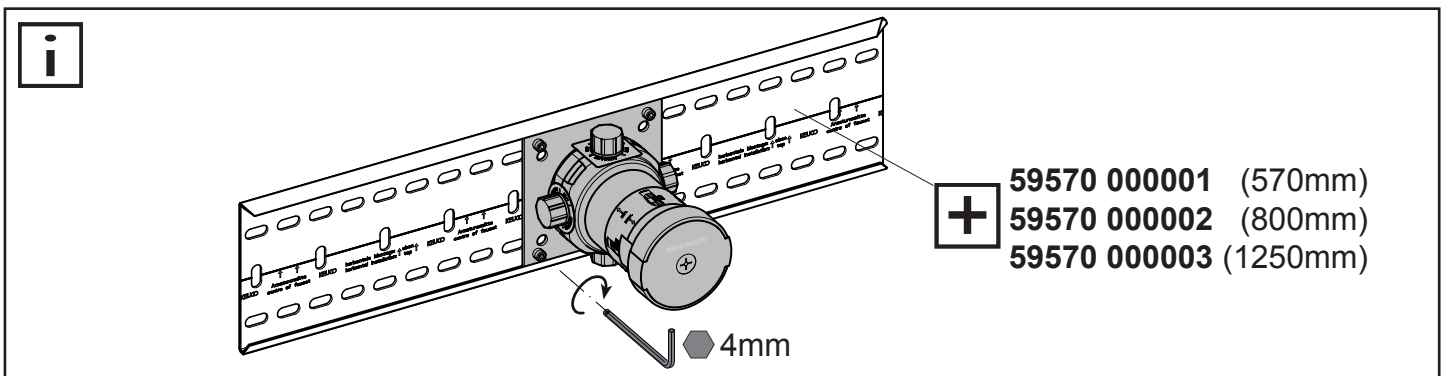
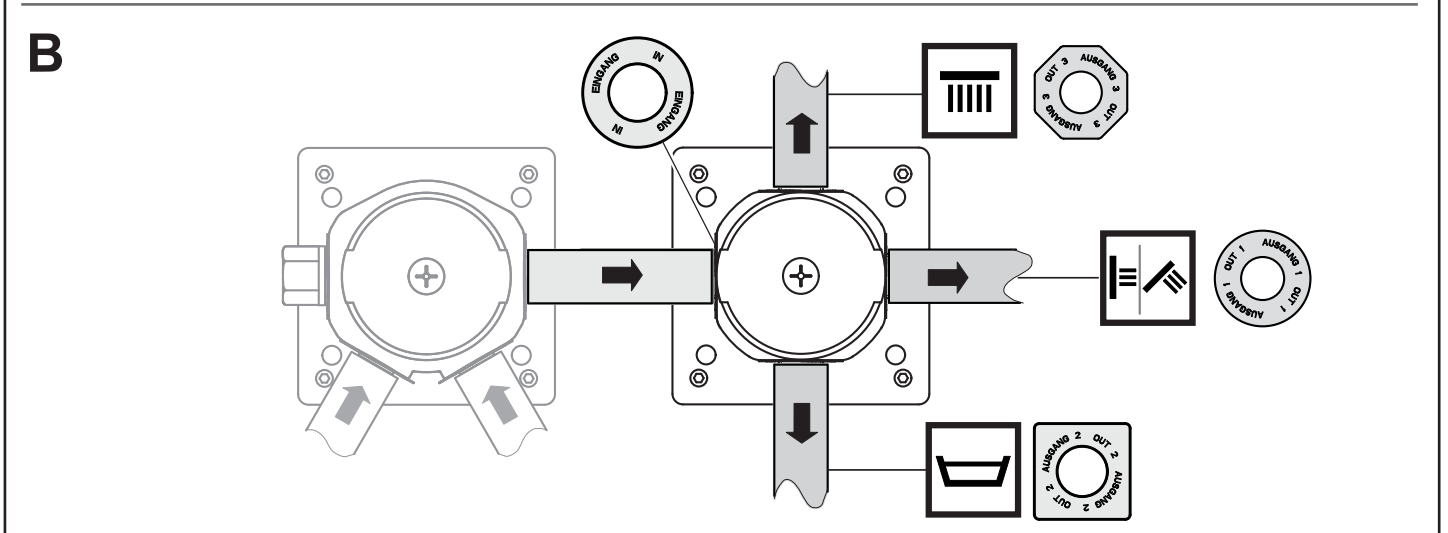
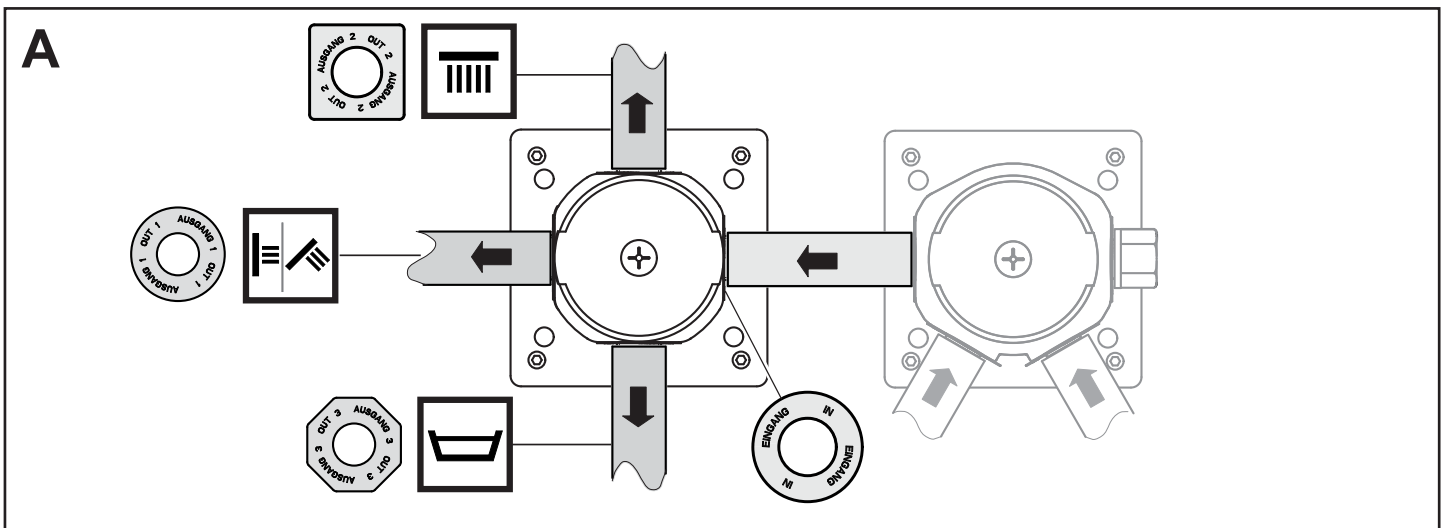
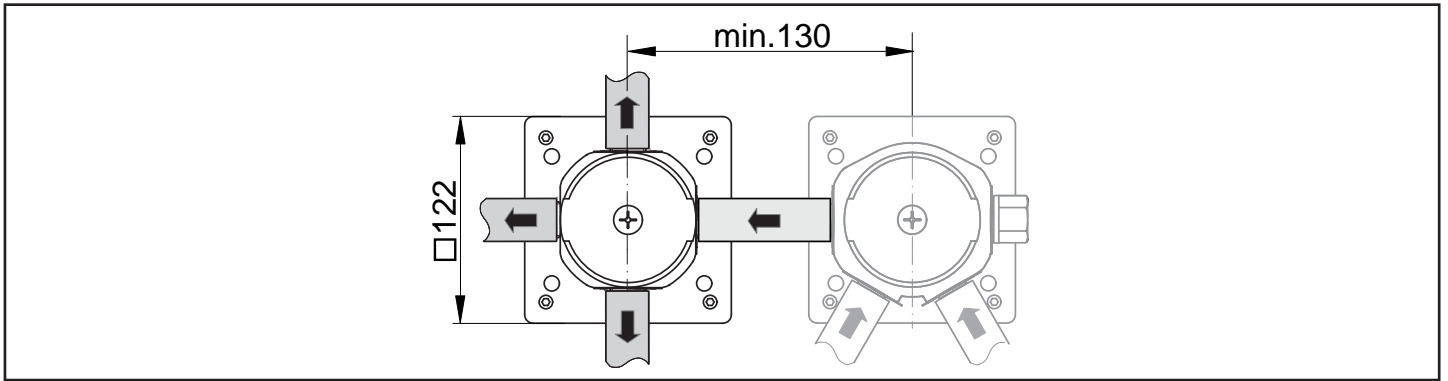



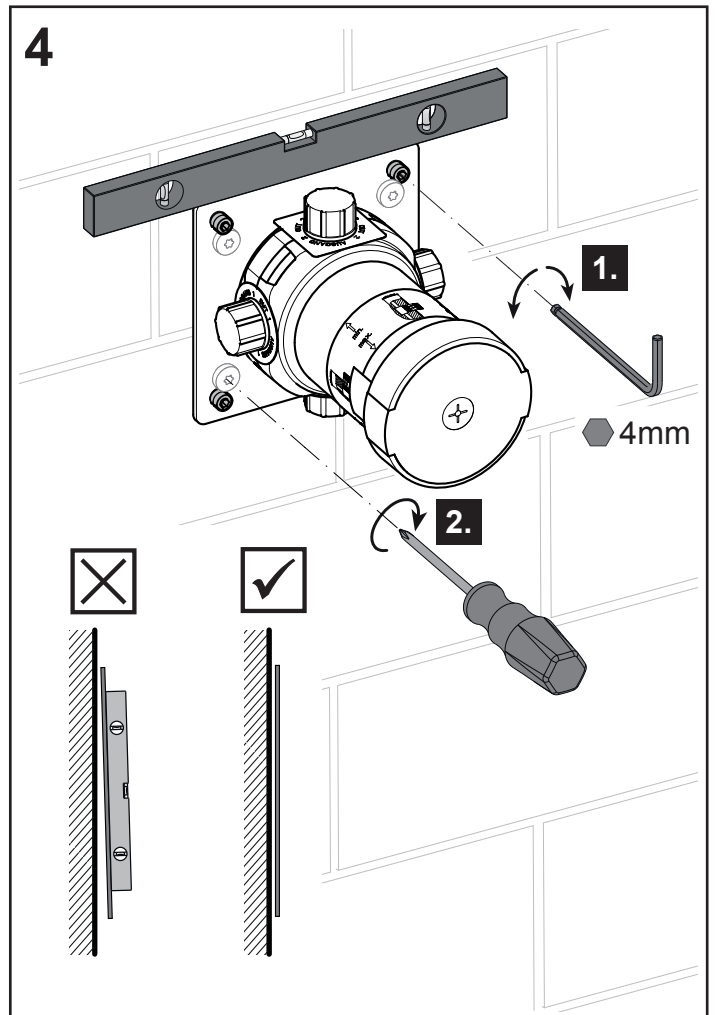
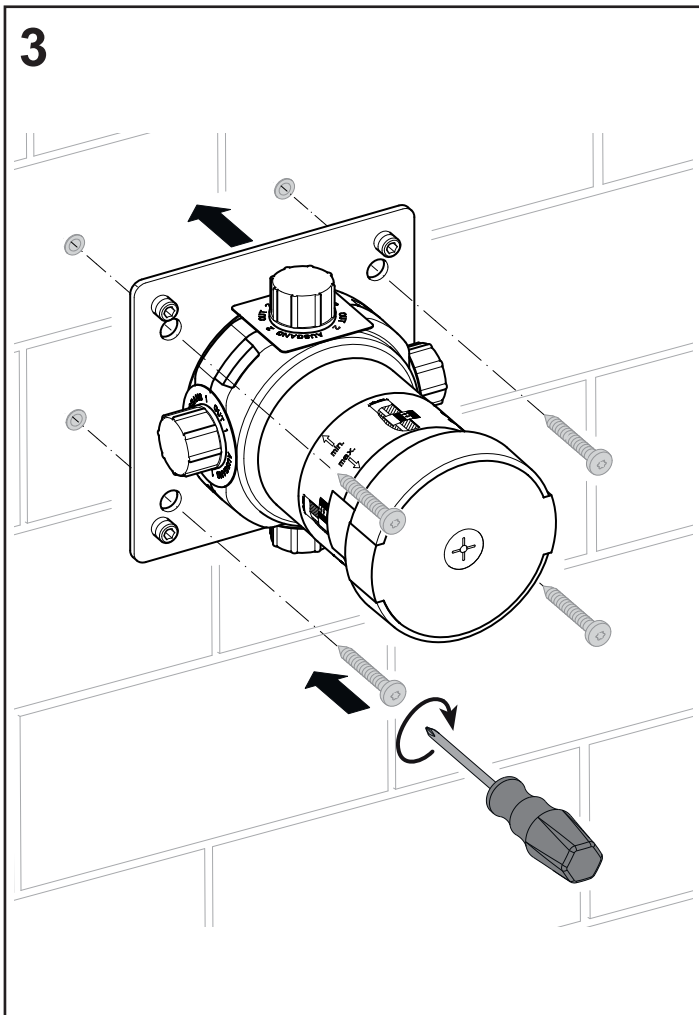
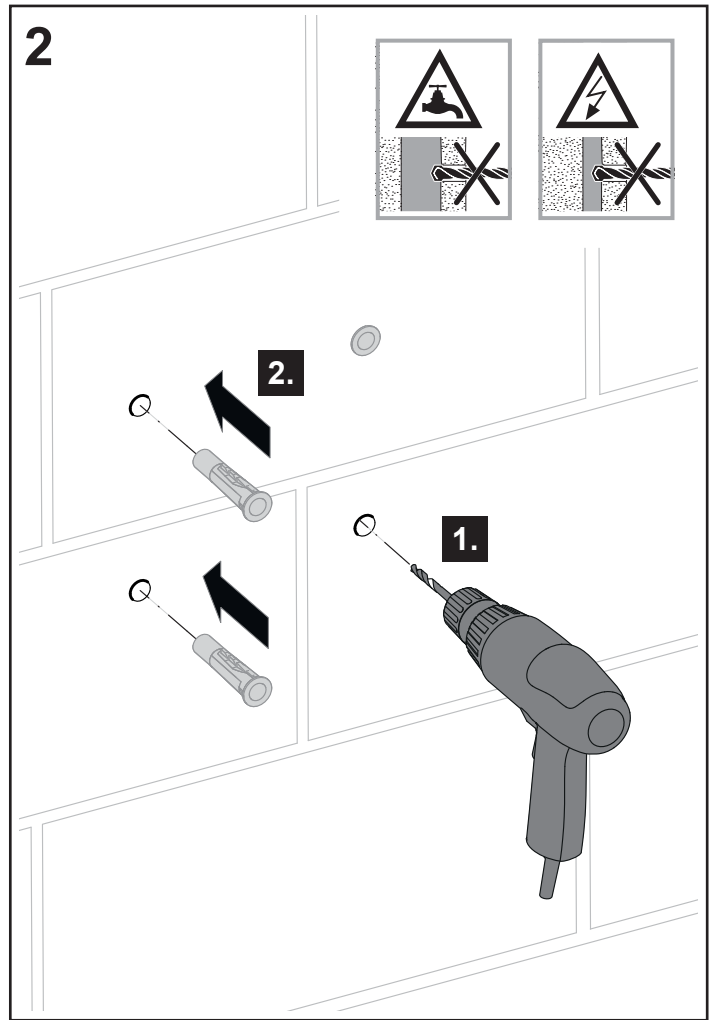
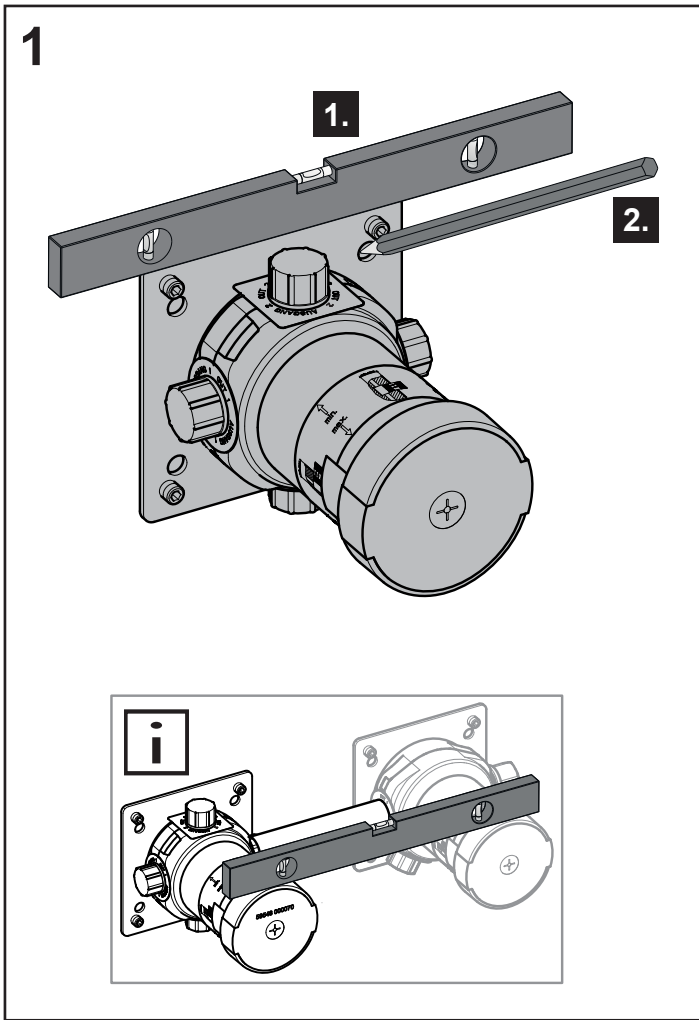

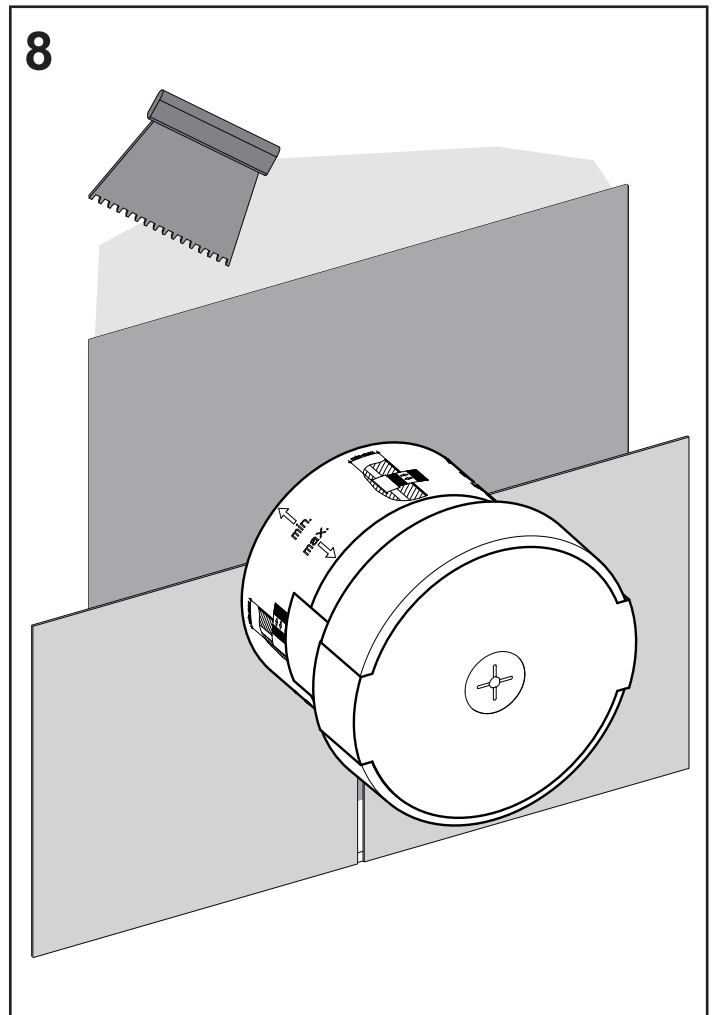
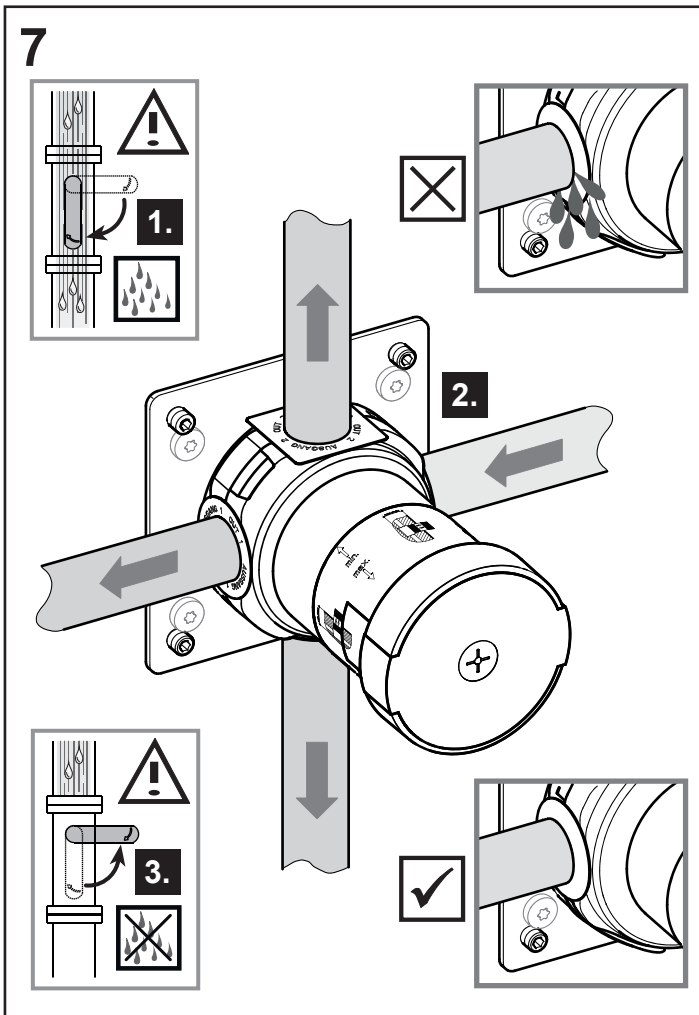
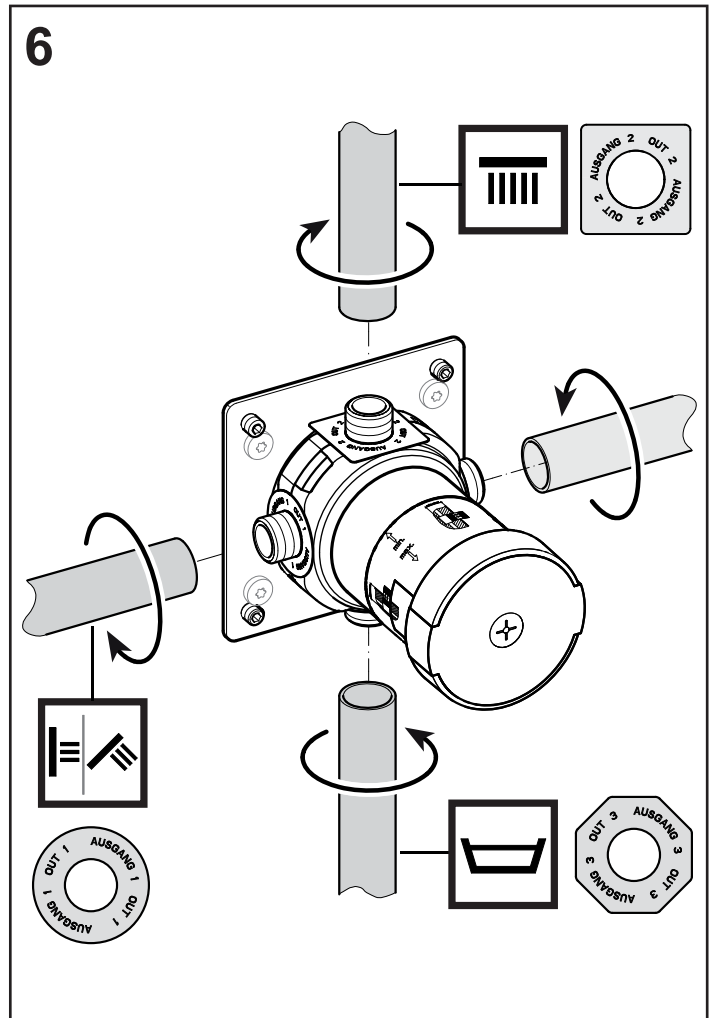
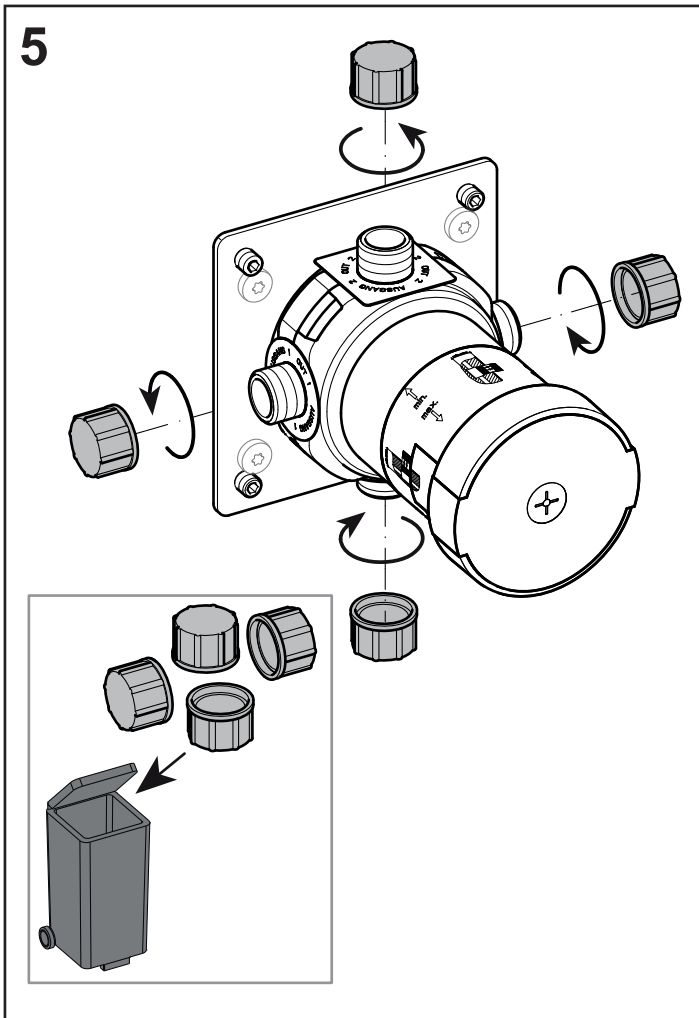

**DE** Ersatzteile

**FR** Liste de pièces

**CS** Sada náhradních

**EN** Spare parts

**IT** Elenco delle parti

**PL** Zestaw części

**ES** Piezas de recambio

**NL** Onderdelen

**RU** Запчасти

