



15 min



AUFBAUANLEITUNG

(1)=2X

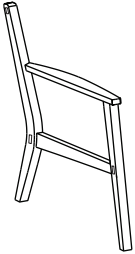





(2)=1X

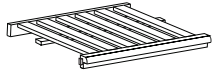

(3)=1X

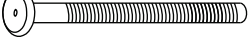

TEILELISTE

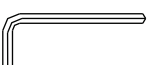
A	 M6x70mm	6X
B	 M6x13mm	6X
C	 M6x35mm	2X
D	 M6x18mm	2X
E	 M6x50mm	1X
L		2X

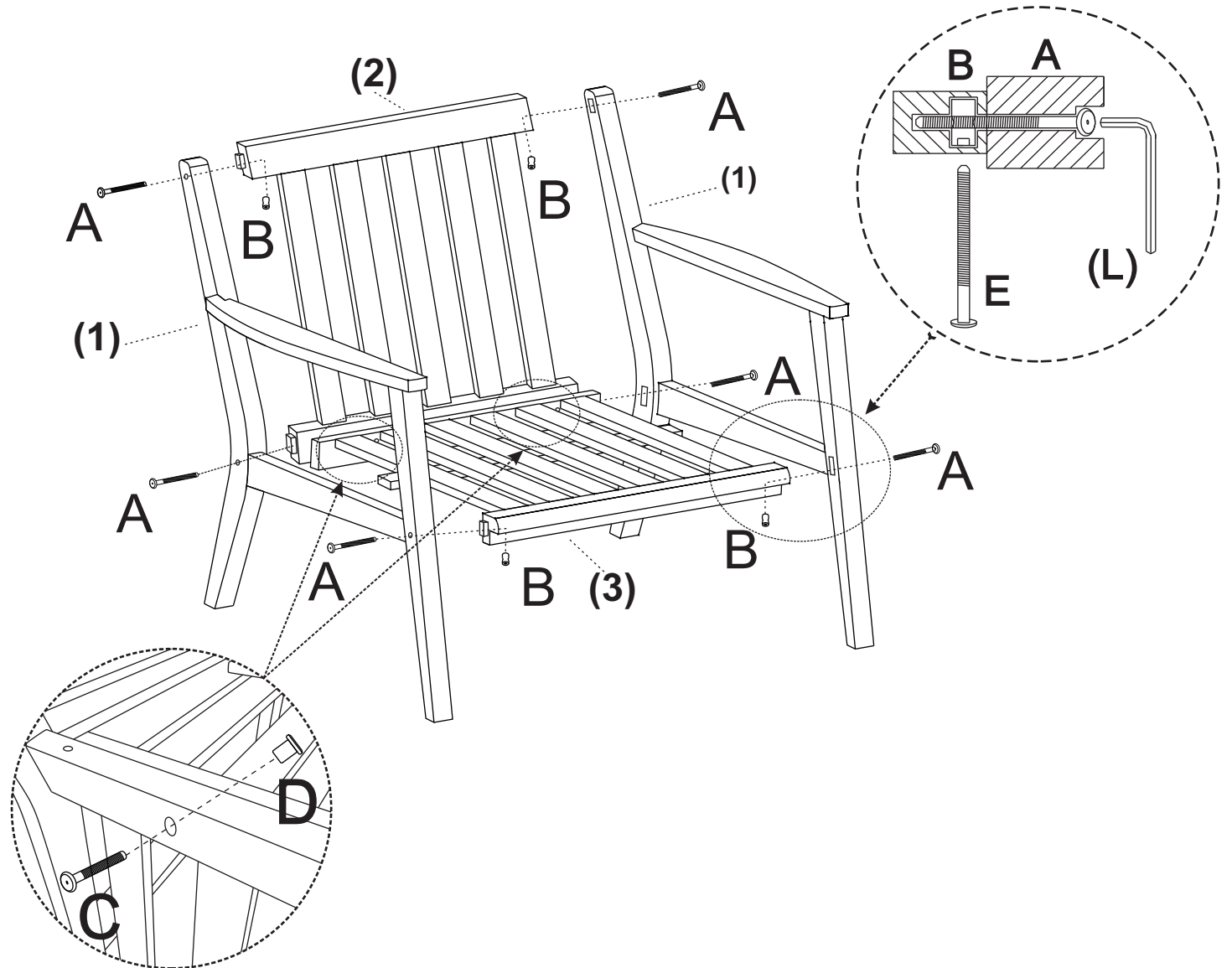

KATHRIN LOUNGESESSEL 74 X 81 X 75CM SUNFUN

Art.: 28607315

Length: **74** cm N.W.: **14,0** kg

Width: **81** cm G.W.: **17,0** kg

Height: **75** cm

BAHAG AG

Gutenbergstr. 21
68167 Mannheim
Germany

service@bauhaus.info



VNM Made