

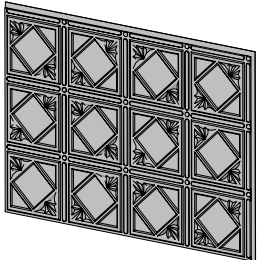

BackSplash Wall Panels

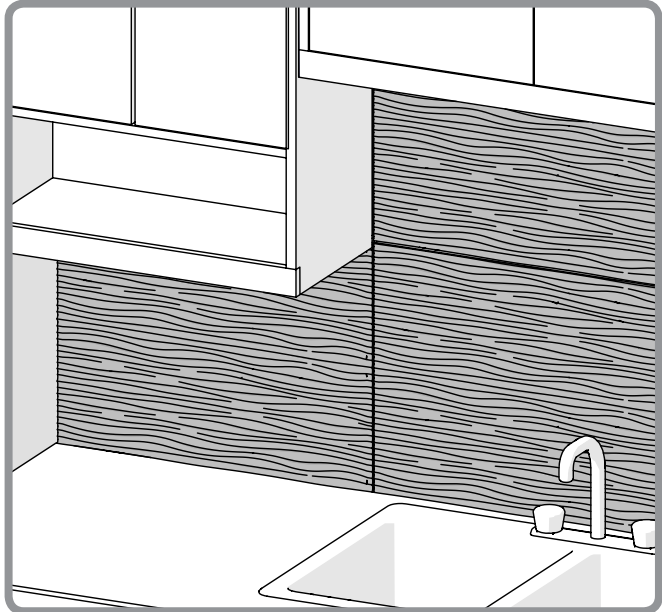

ARTNOUVO

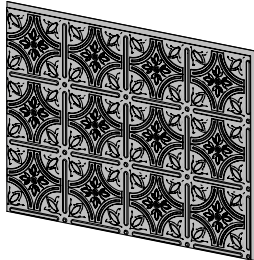

EMPIRE

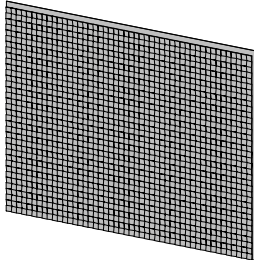

QUADRATE

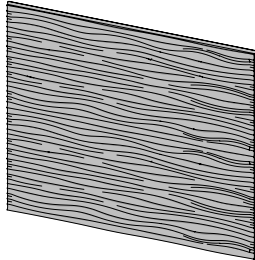

WILDERNESS

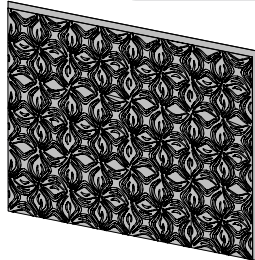

ORCHID

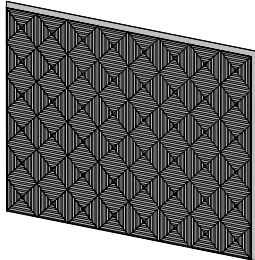

RHOMBUS

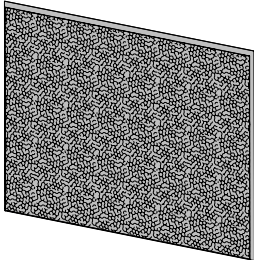

LAMINA

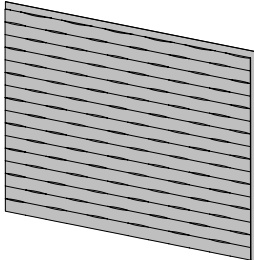

LATTICE

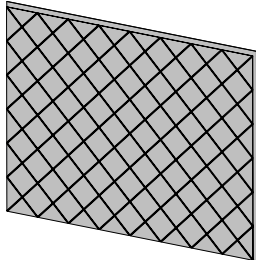

CRISS

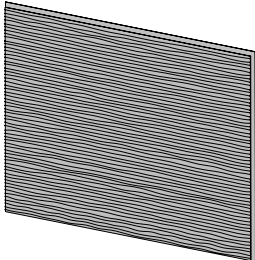

SAHARA

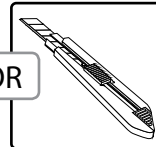
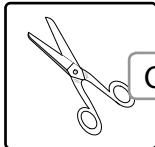
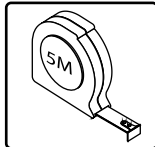
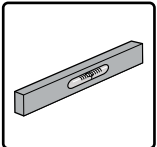

OR

General Information prior to installation :

1. Surface and panels must be clean, dry smooth and free of dust, grease, wax and or any other particales priot to installation
2. Clean the back surface of the panel, use a clean cloth and rubbing alcohol
3. Prepare a detailed plan, measure the area planned to be covered to determine how many panels you will need prior to cutting and installing.
4. Adhesives - Use high quality, strong, one component adhesive and sealant based on MS polymer 5

Installing the Panels :

Step 1: Prepare a detailed plan, in accordance with your chosen option, measure the area planned to be covered prior to starting the installation.

Step 2: Apply adhesive onto the high points at the panels' back side.
Make sure you apply the adhesive on all spots as well as onto the overlap between the panels.

* Please pay attention to the connection between the panels, it is important to use an adhesive in the connection between the overlapping panels, press the panels to the wall with your fingers and use a masking tape.

Step 3: If the panels need cutting, please do so in advance using scissors or a utility knife.

Step 4: After installing all the panels and applying masking, wait for 24 hours until the adhesive dries totally prior to removing the masking tape.

1

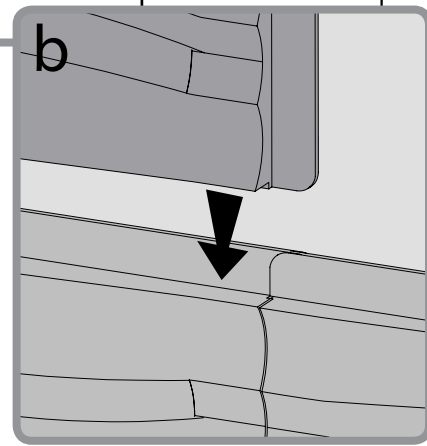
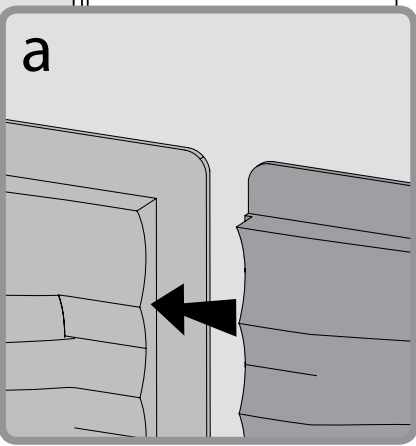
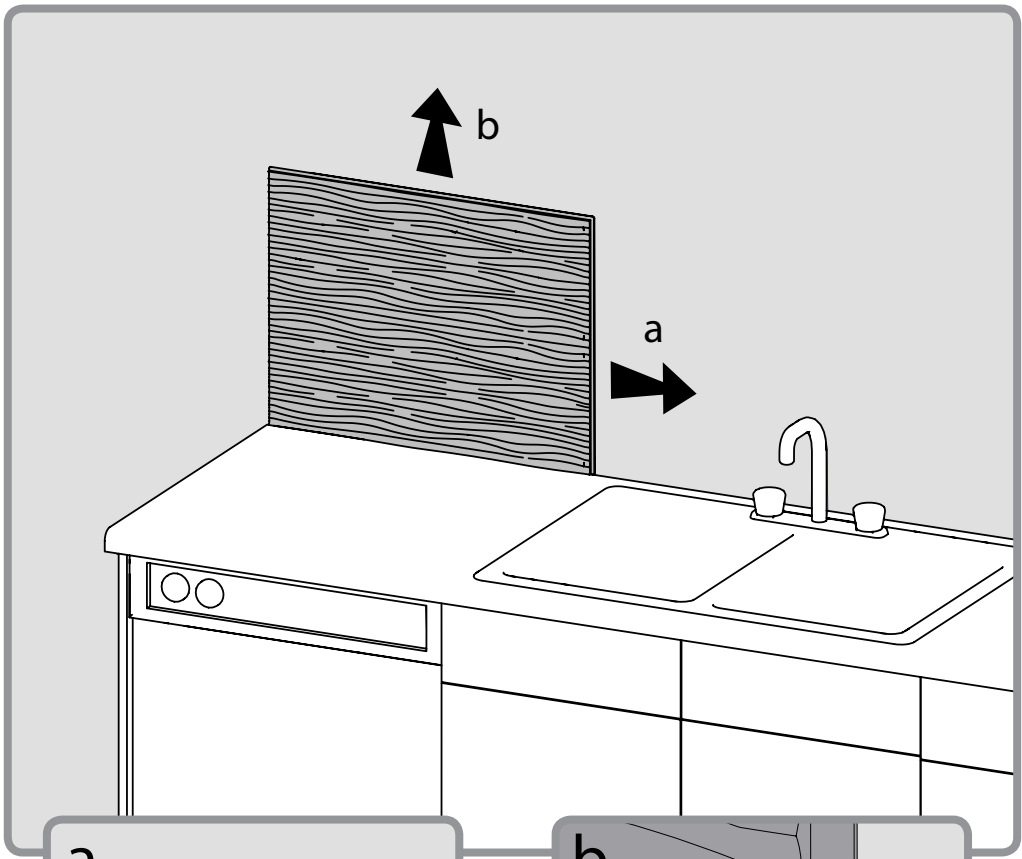

2

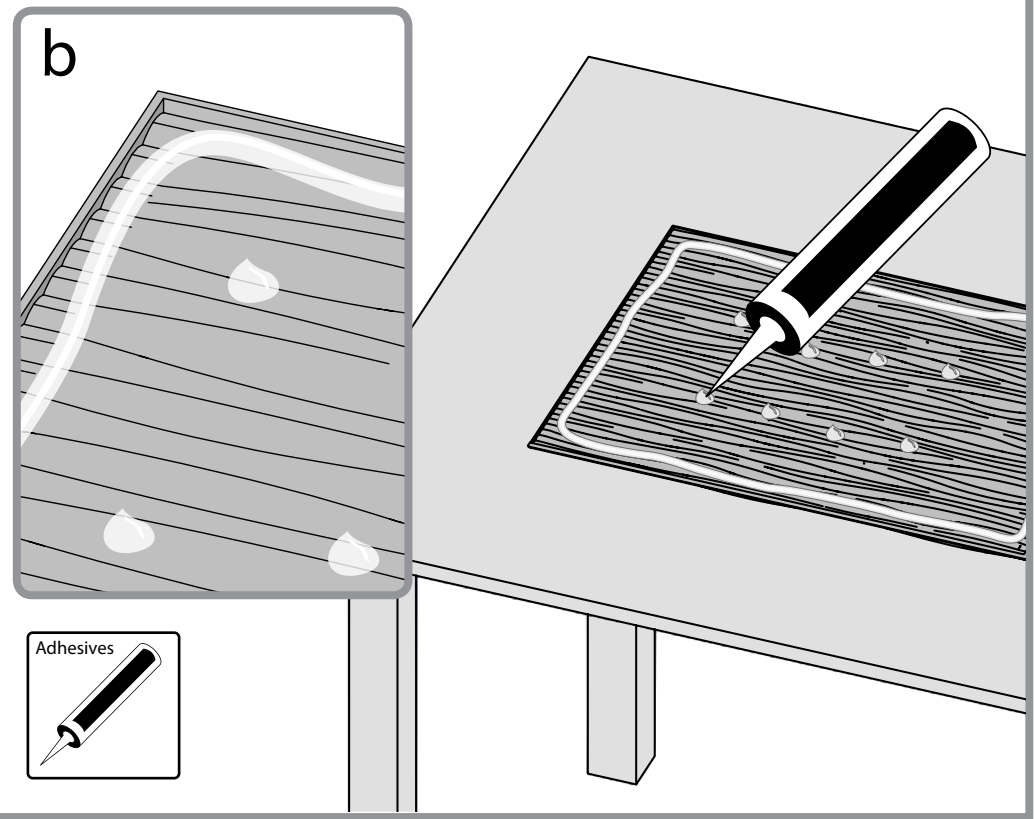
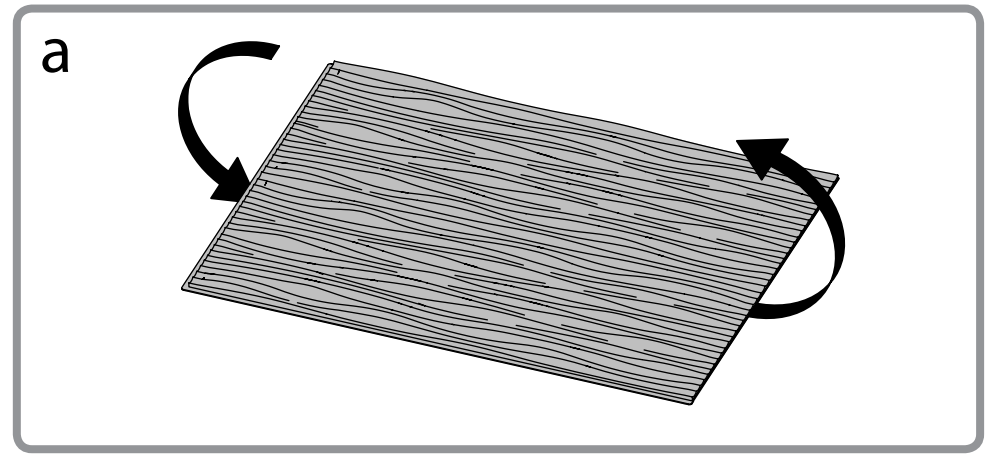

3

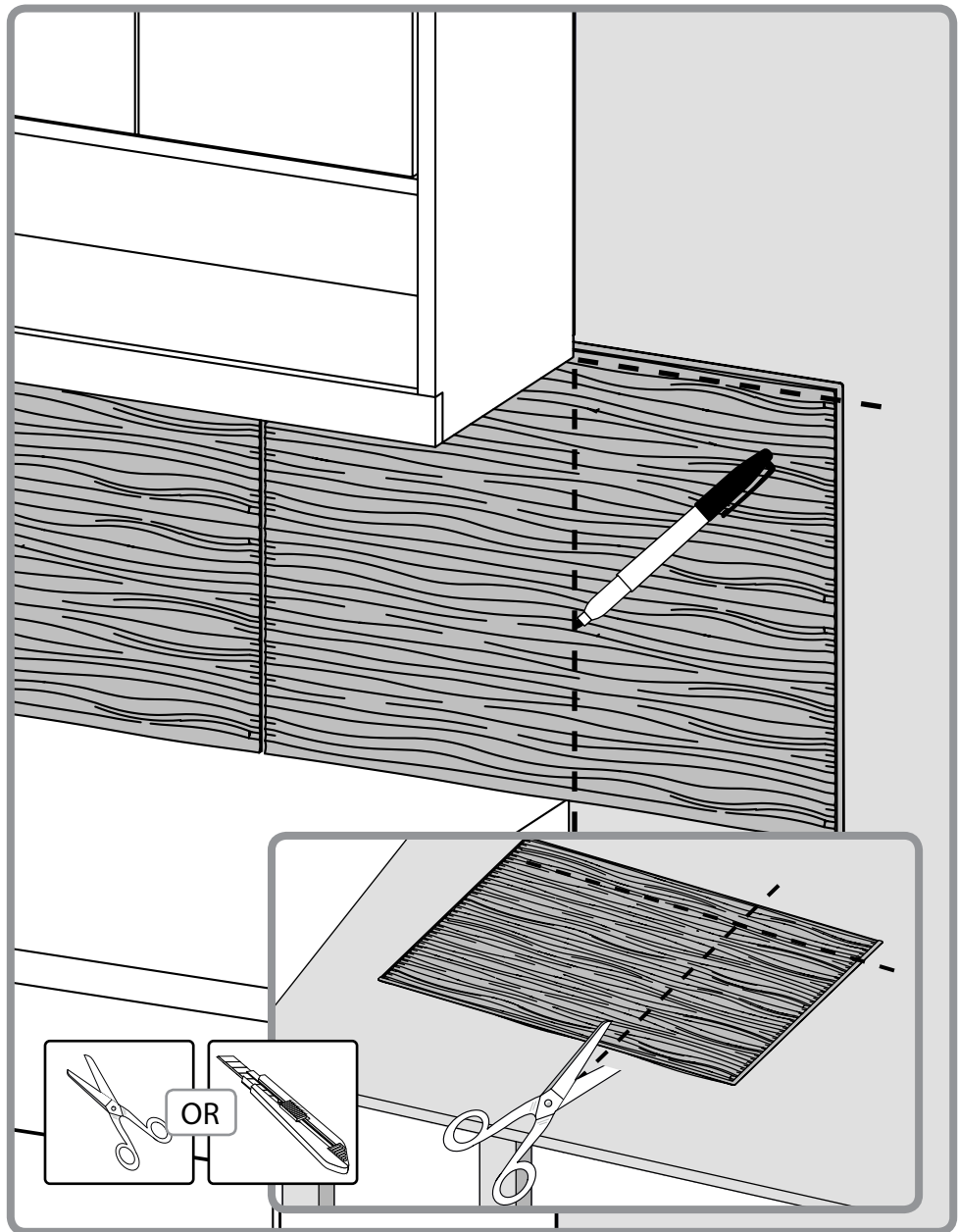
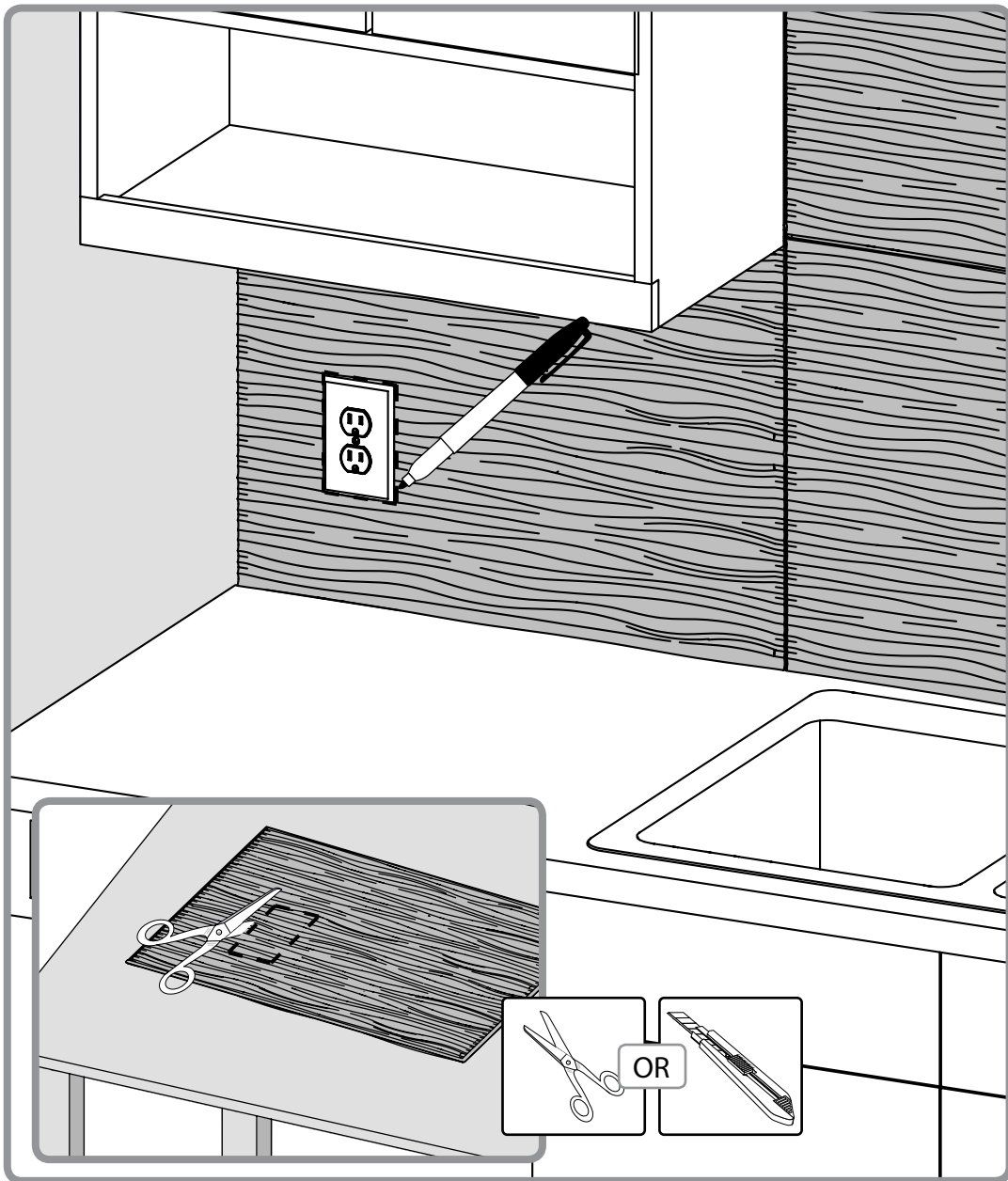

4

