

Multiplex Trio

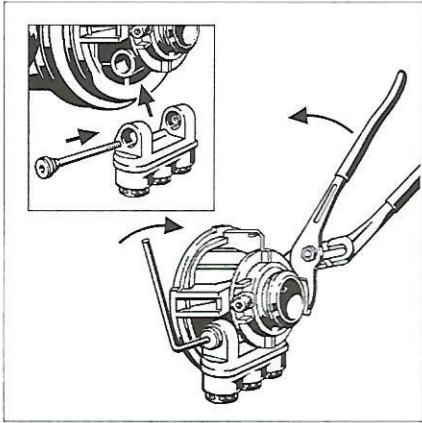

1

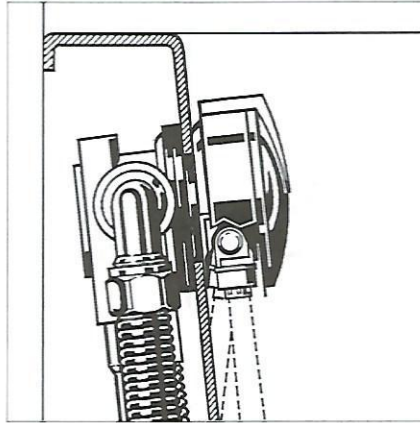

2

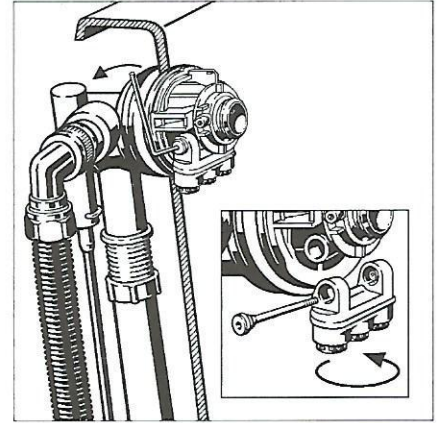

3

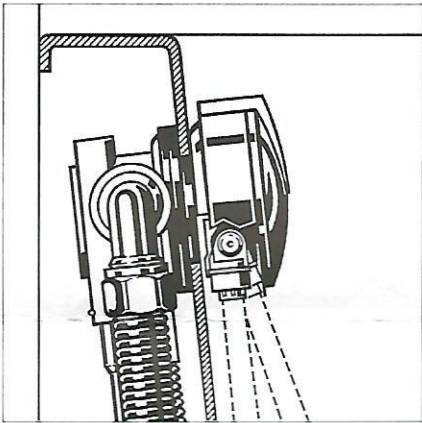

4

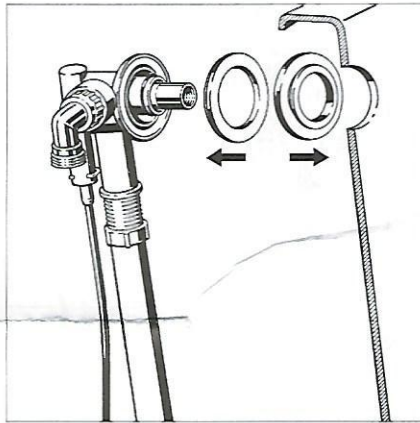

5

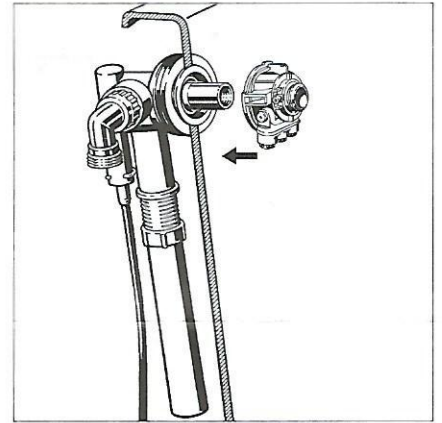

6

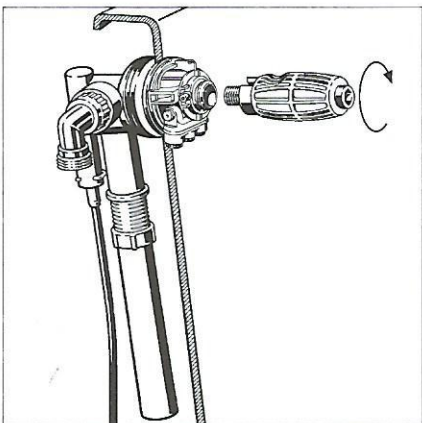

7

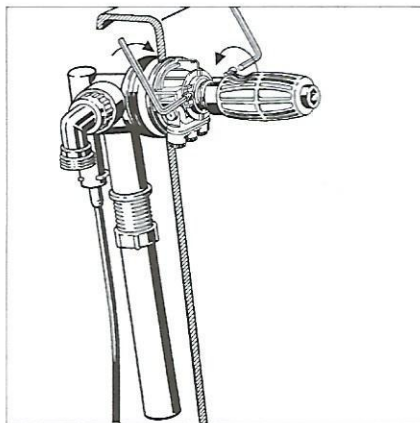

8

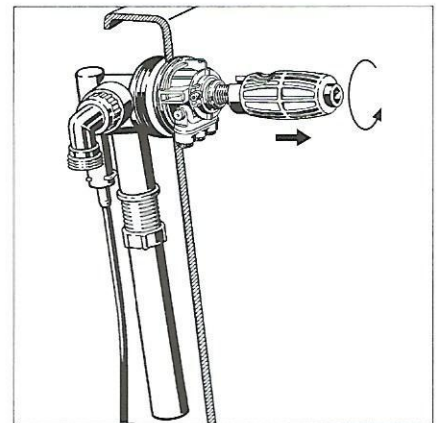

9

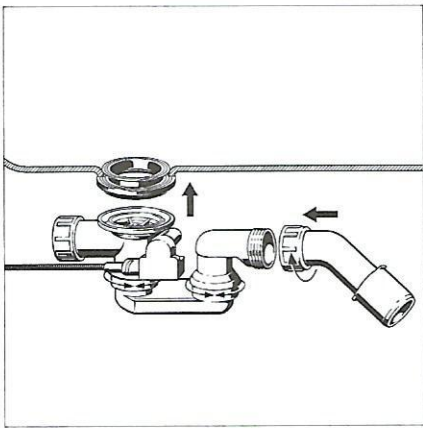

10

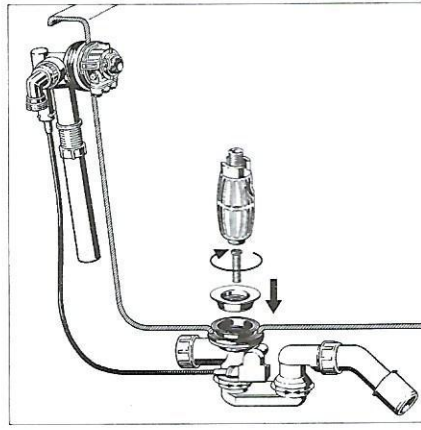

11

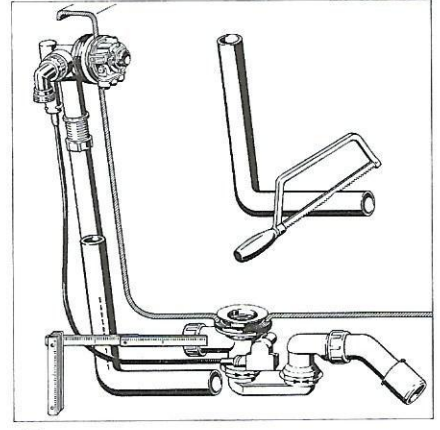

12

DIN 1988 (TRWI) Teil 4

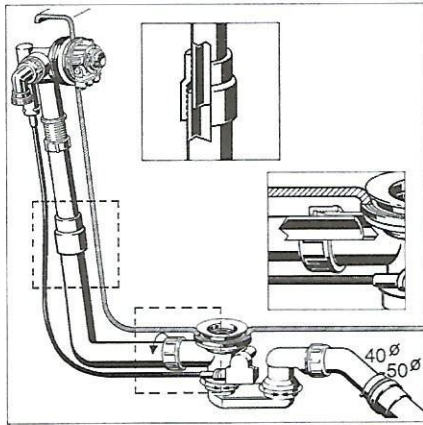

13

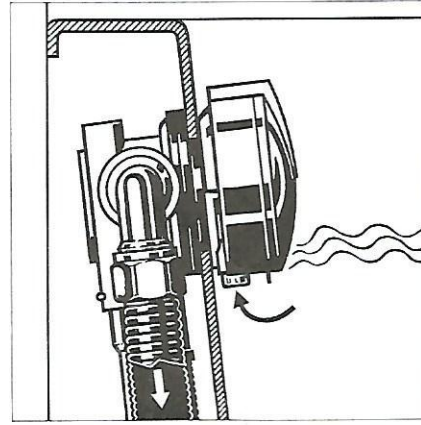

14

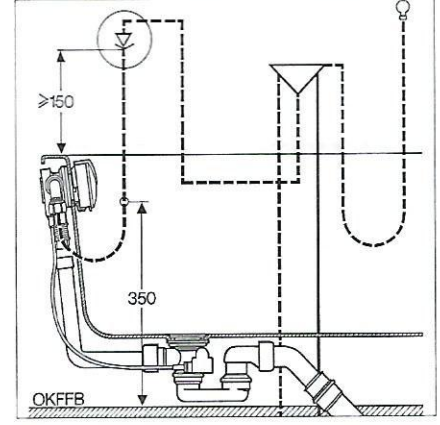

15

DIN 1988 (TRWI) Teil 5

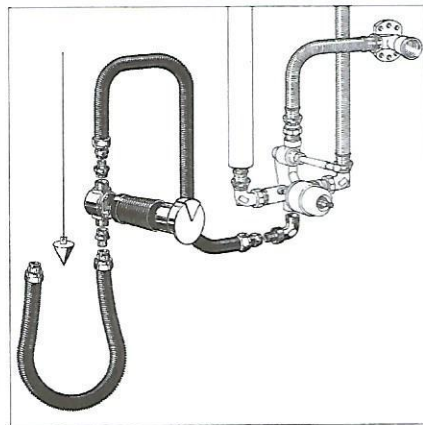

16

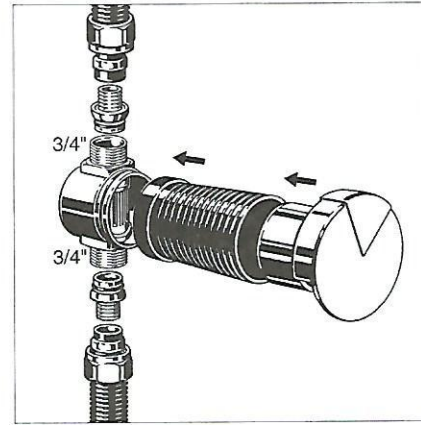

17

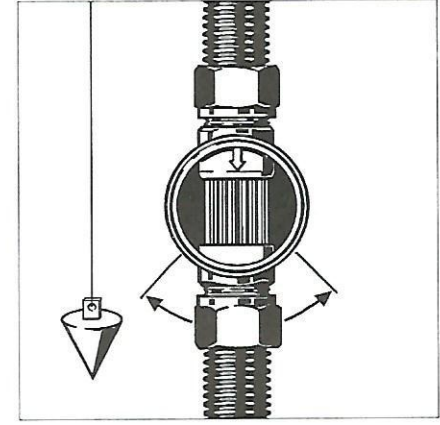

18

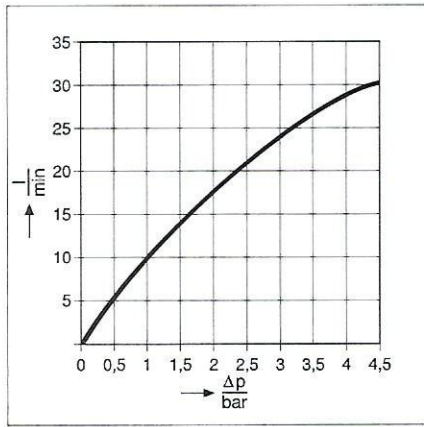

19

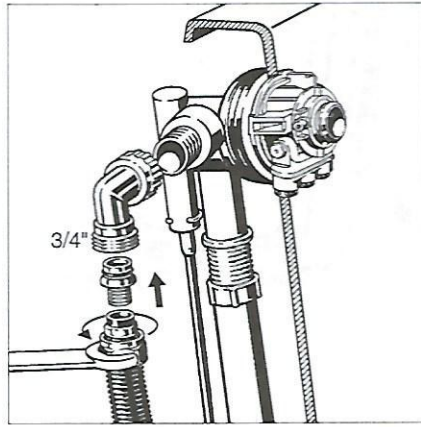

20

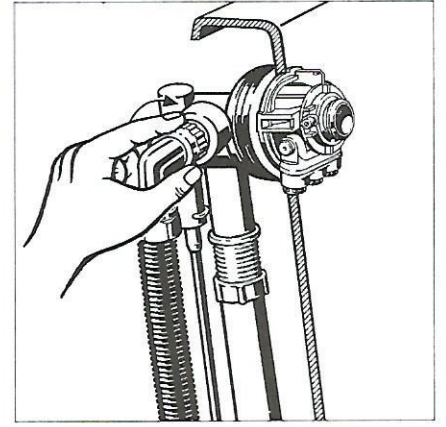

21

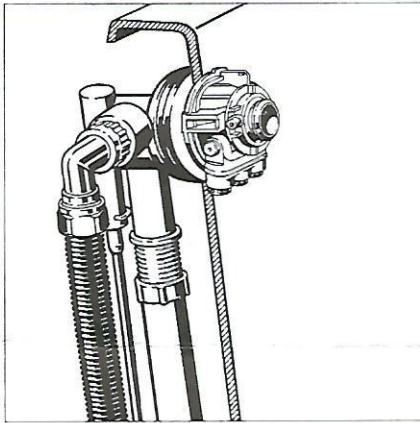

22

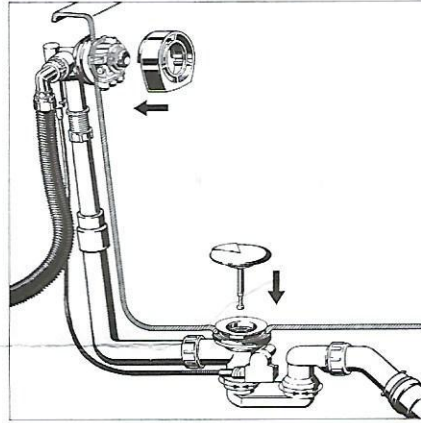

23

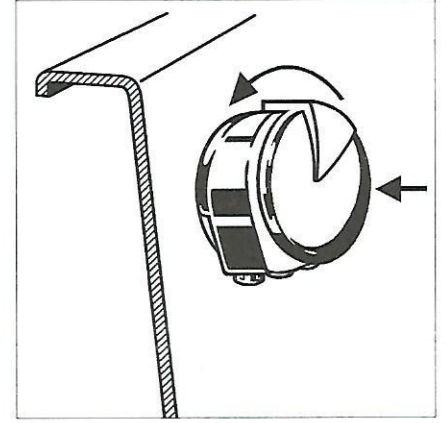

24

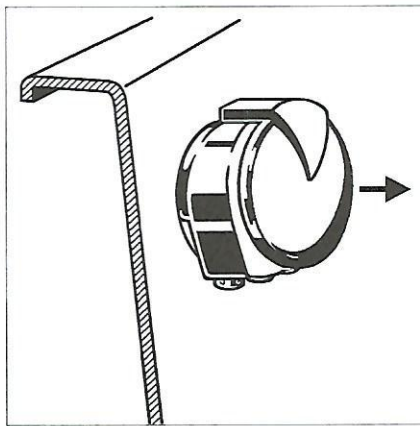

25

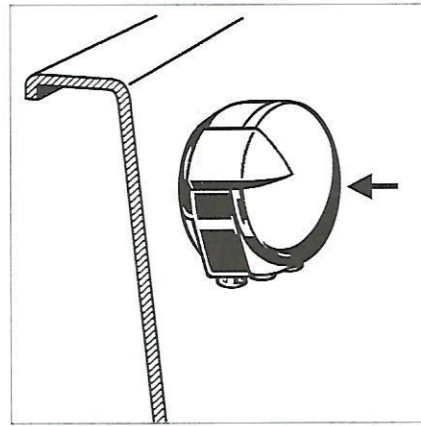

26

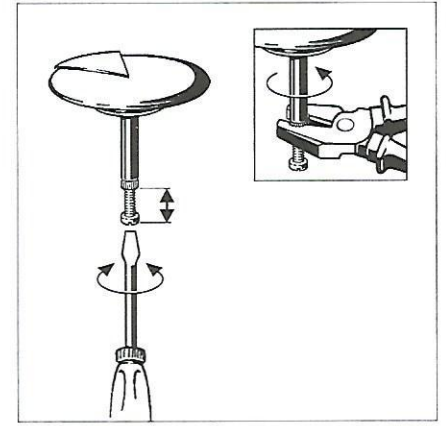

27

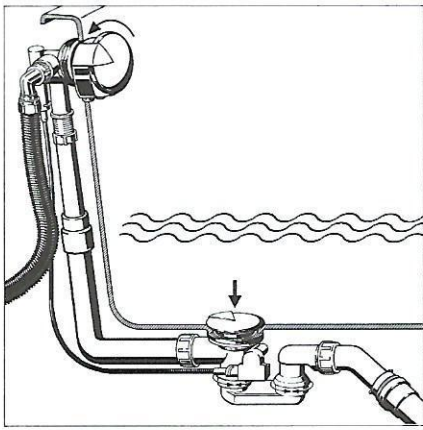

27

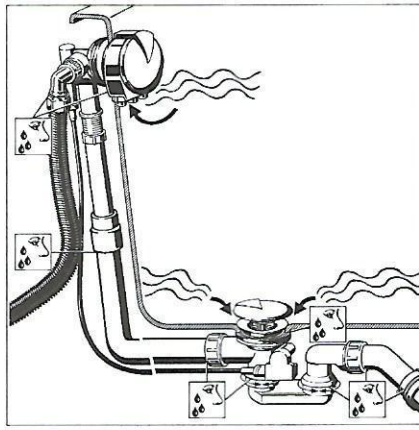

28