

Model	2828780	Seite/Page	1
Zeichnung/Drawing	3D	Maßstab/Scale	
Profil/Profile	28x135	Datum/Date	03.10.2025
Zeichner/Drafter	SRM	File	2828780.dwg

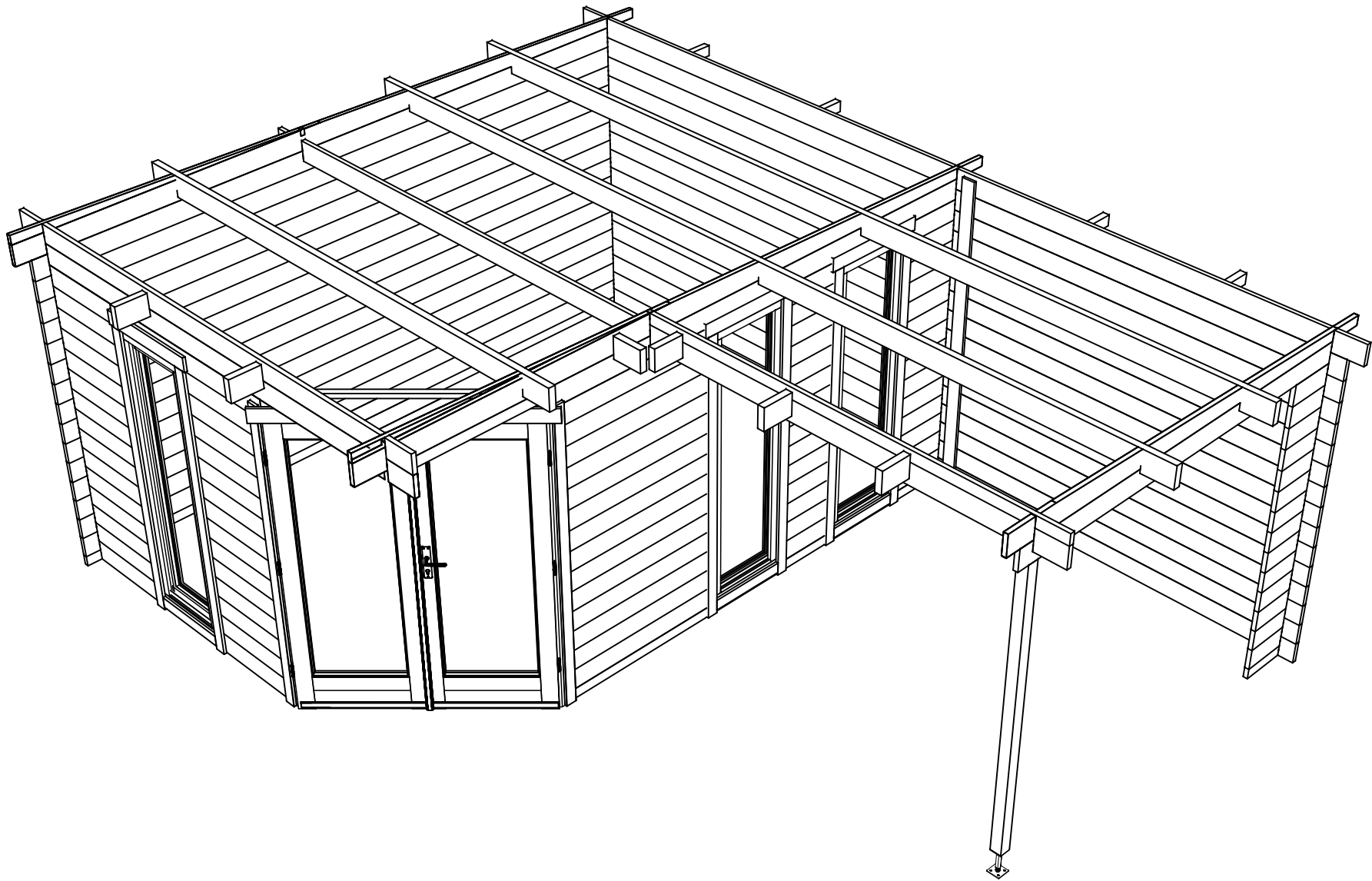

Model	2828780	Seite/Page	2
Zeichnung/Drawing	3D	Maßstab/Scale	
Profil/Profile	28x135	Datum/Date	03.10.2025
Zeichner/Drafter	SRM	File	2828780.dwg

H = 1.700 m
 TOTAL: 18.43 m²

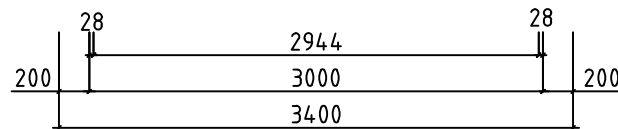
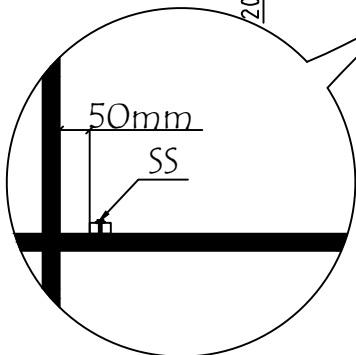
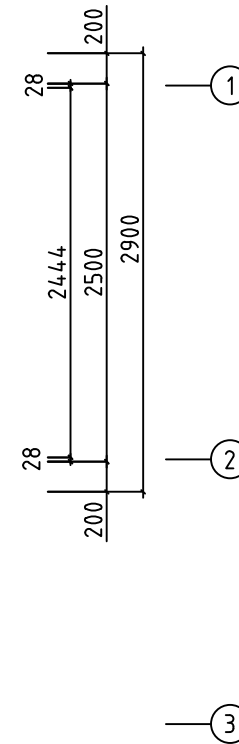
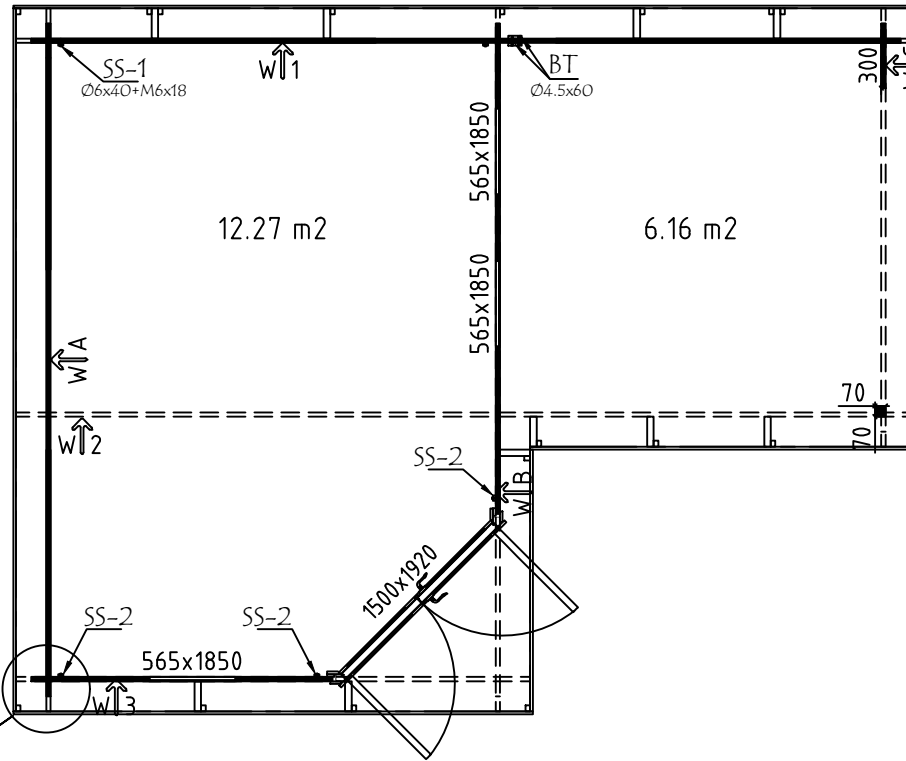
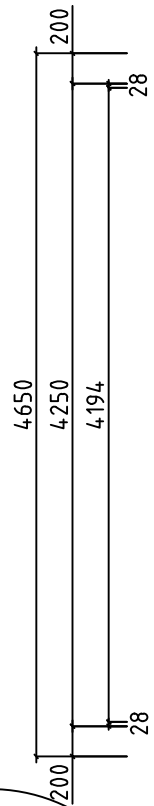
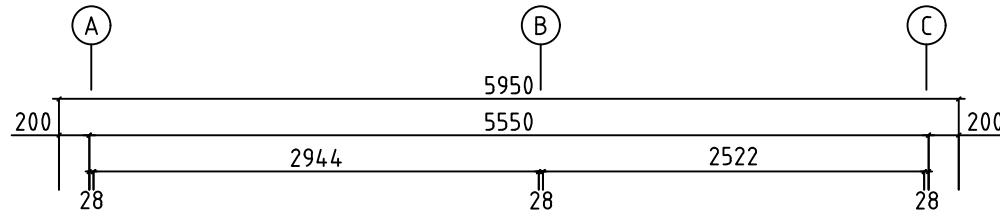

Model	2828780	Seite/Page	3
Zeichnung/Drawing	GRUNDPLAN - GRUNDPLAN	Maßstab/Scale	1:50
Profil/Profile	28x135	Datum/Date	03.10.2025
Zeichner/Drafter	SRM	File	2828780.dwg

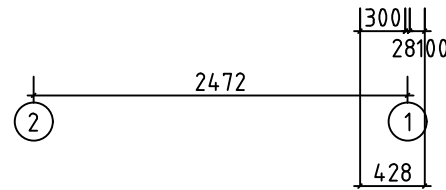
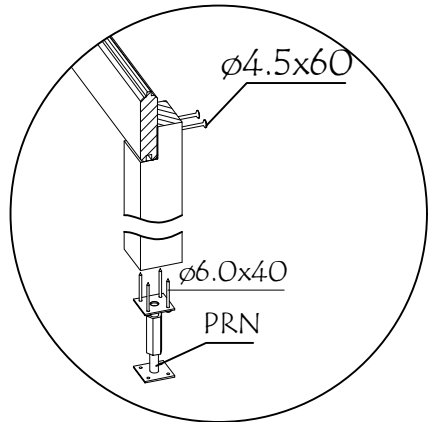
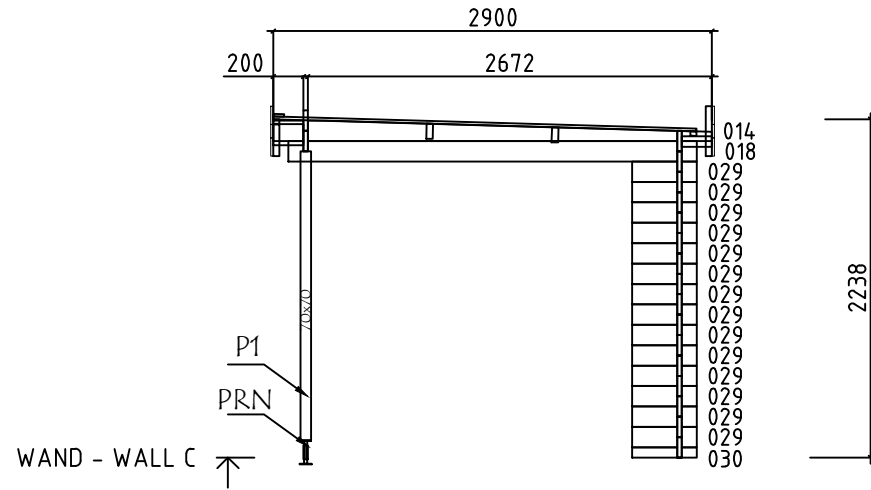
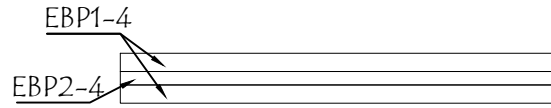

Model	2828780	Seite/Page	6
Zeichnung/Drawing	WAND - WALL C	Maßstab/Scale	1:50
Profil/Profile	28x135	Datum/Date	03.10.2025
Zeichner/Drafter	SRM	File	2828780.dwg

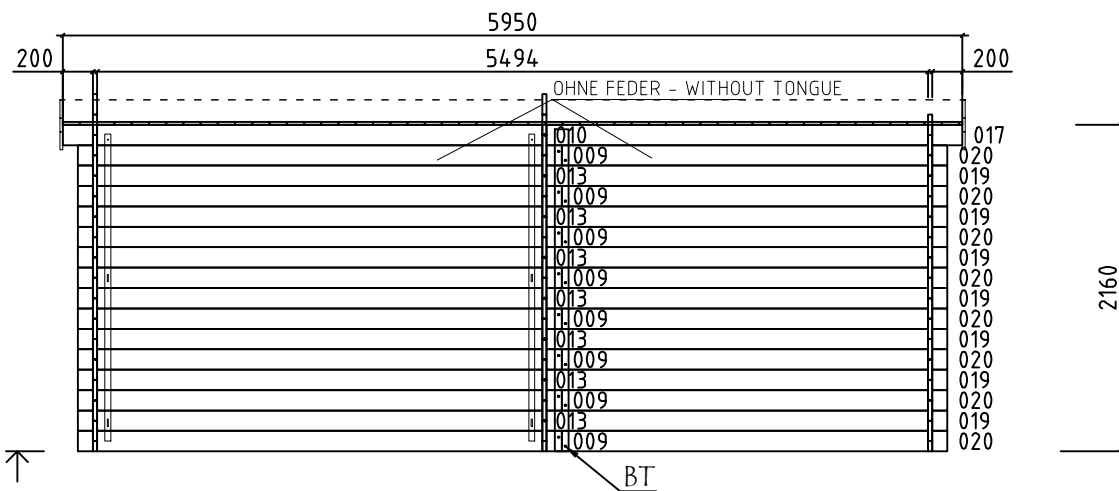
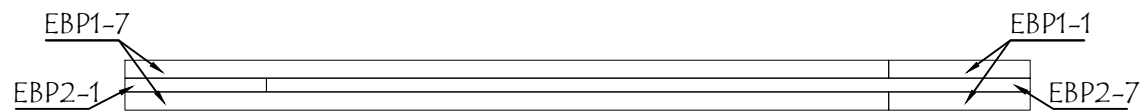

WAND - WALL 1 ↑

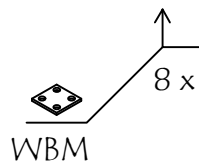
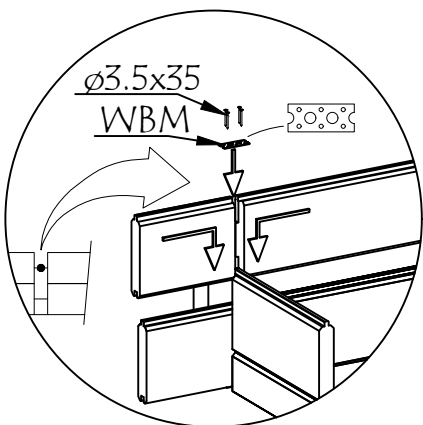
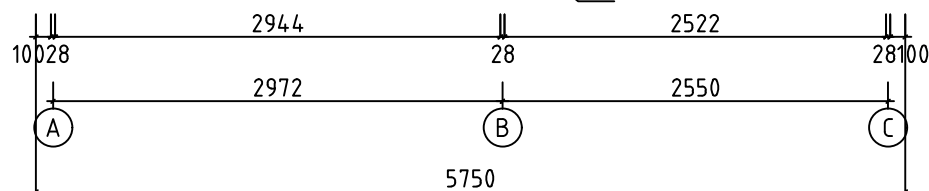

Model	2828780	Seite/Page	7
Zeichnung/Drawing	WAND - WALL 1	Maßstab/Scale	1:50
Profil/Profile	28x135	Datum/Date	03.10.2025
Zeichner/Drafter	SRM	File	2828780.dwg

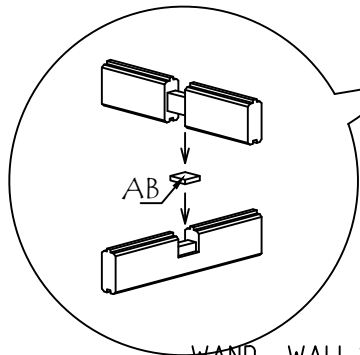
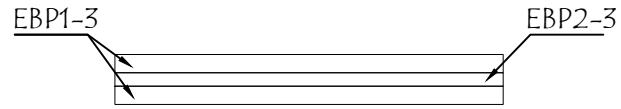

WAND - WALL 2 ↗

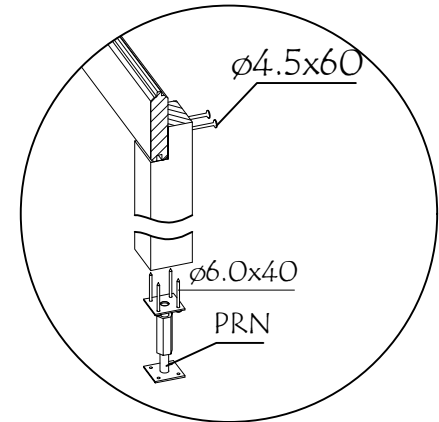
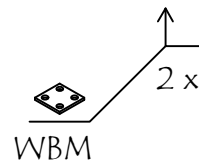
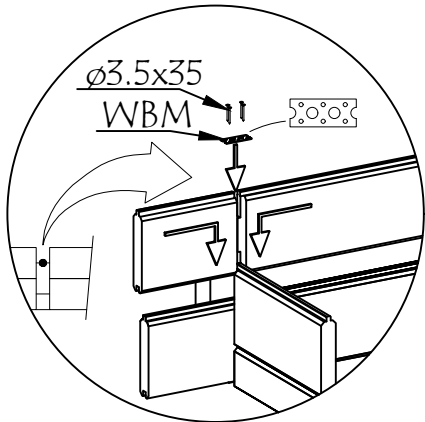
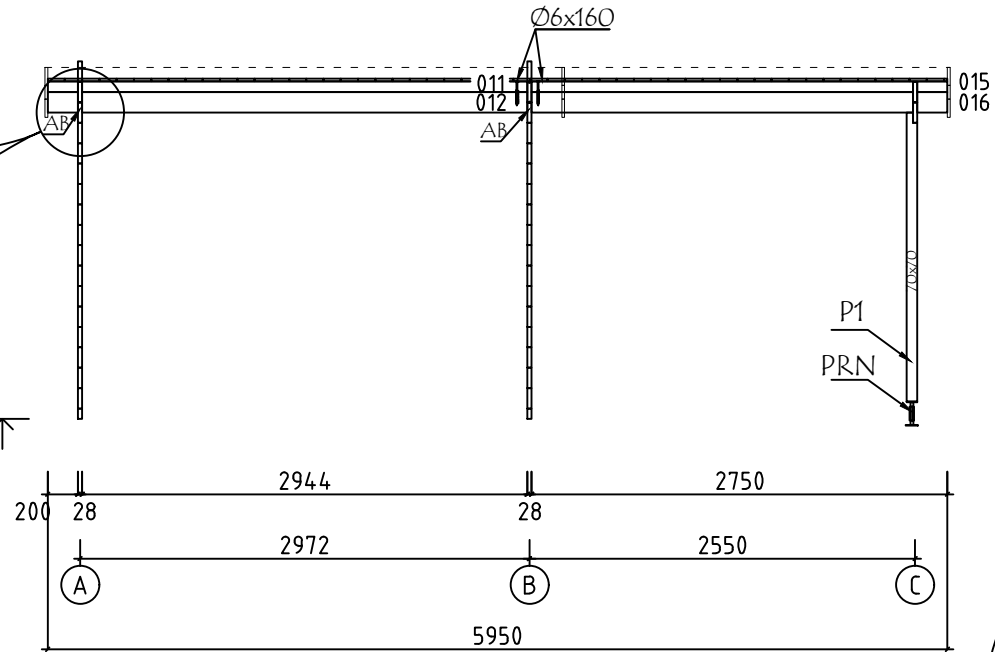

Model	2828780	Seite/Page	8
Zeichnung/Drawing	WAND - WALL 2	Maßstab/Scale	1:50
Profil/Profile	28x135	Datum/Date	03.10.2025
Zeichner/Drafter	SRM	File	2828780.dwg

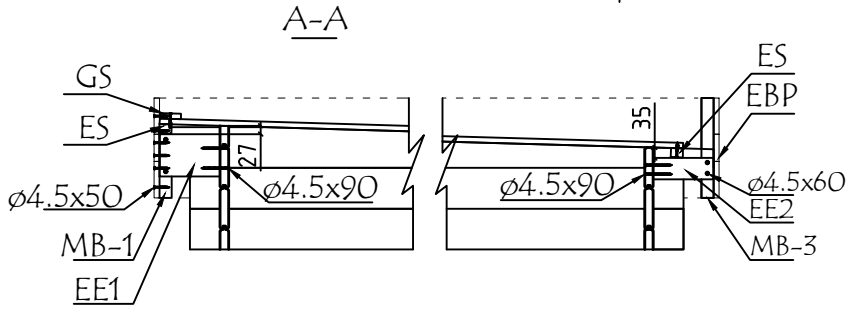
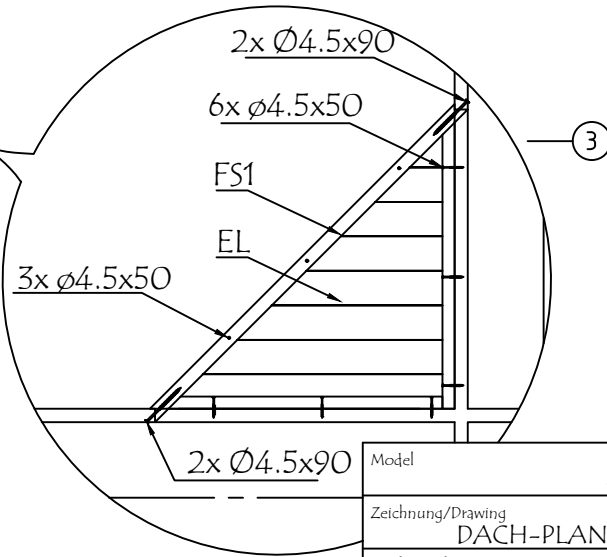
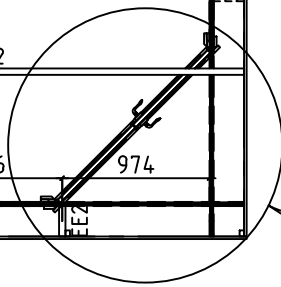
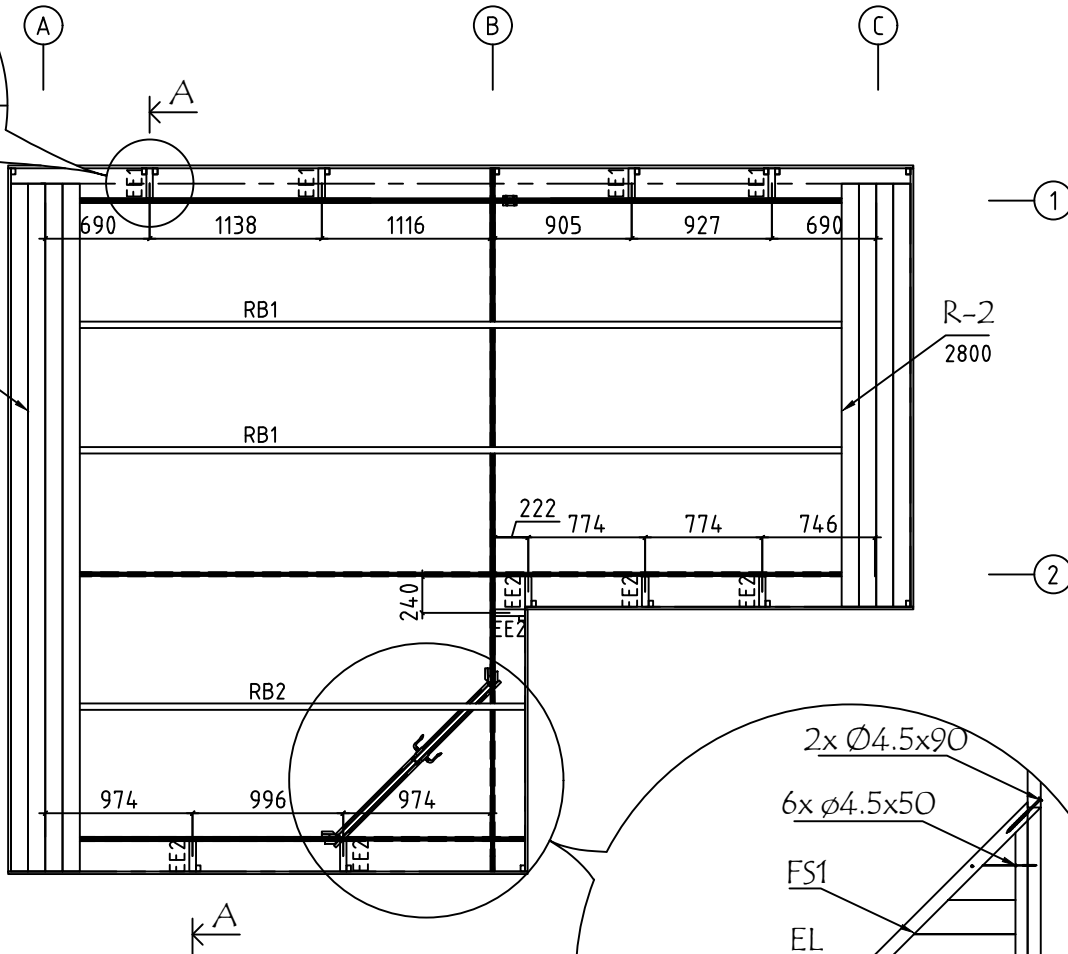
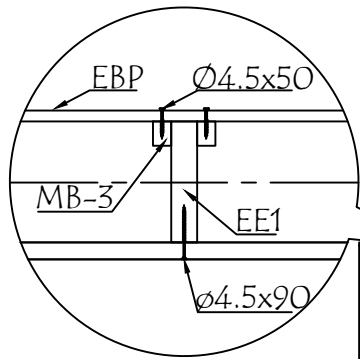

Model	2828780	Seite/Page	10
Zeichnung/Drawing	DACH-PLAN - ROOF PLAN	Maßstab/Scale	1:50
Profil/Profile	88x18 oder- or 114x18 / 43x140	Datum/Date	03.10.2025
Zeichner/Drafter	SRM	File	2828780.dwg

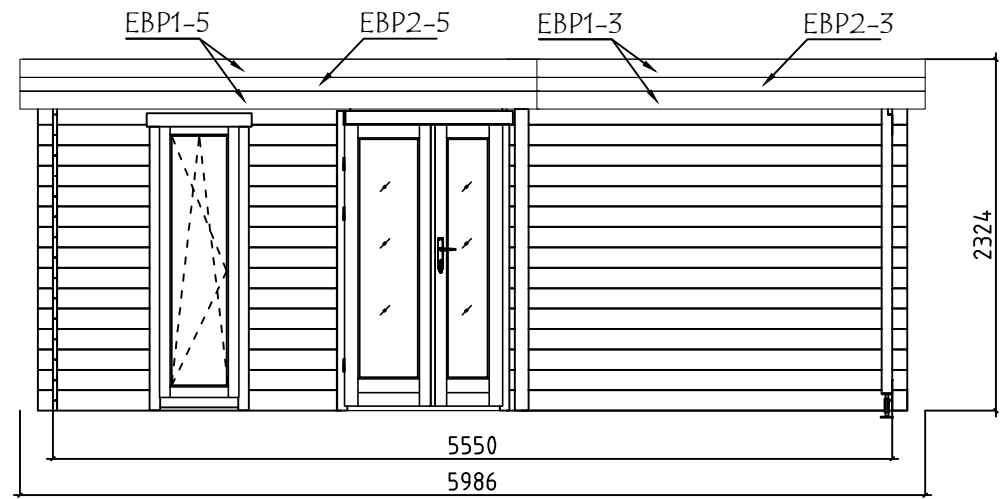

VORDERANSICHT-FRONT VIEW

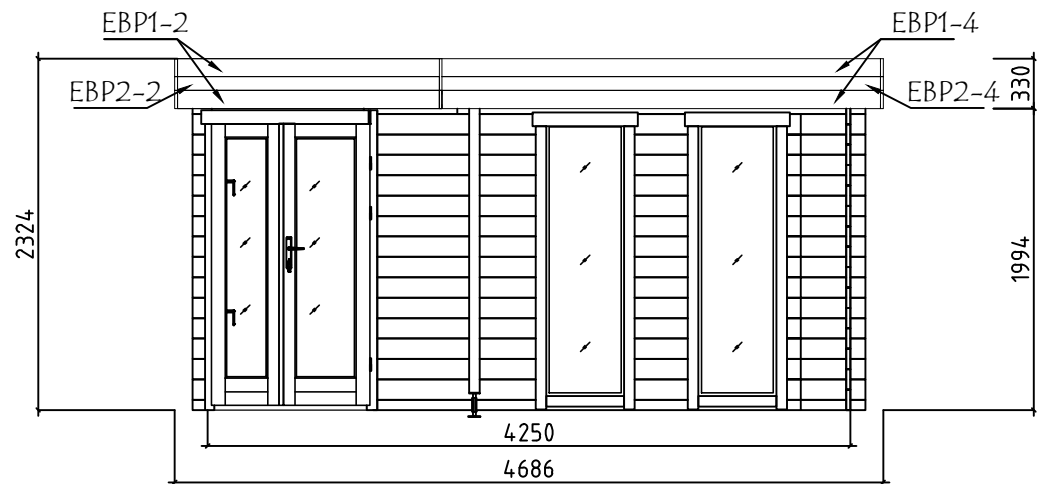

SCALE: NOT TO SCALE







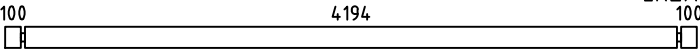
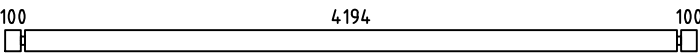
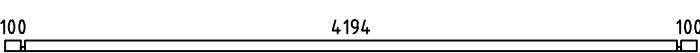
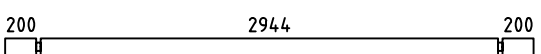
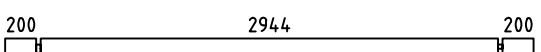
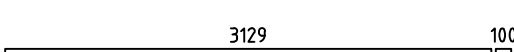
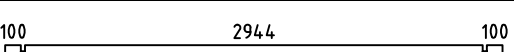
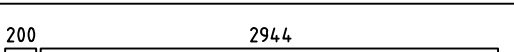
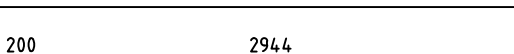
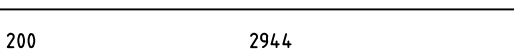
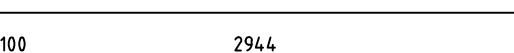
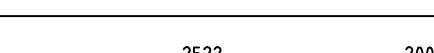
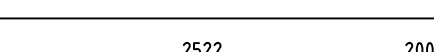
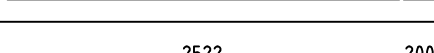
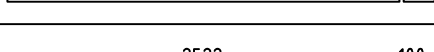
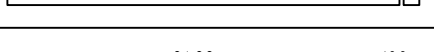
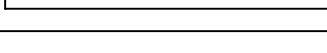
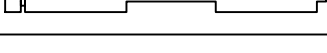
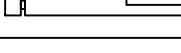
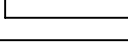
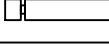





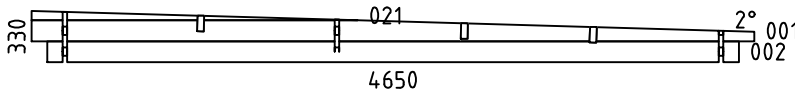
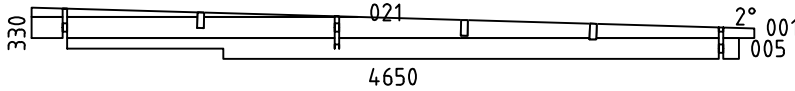
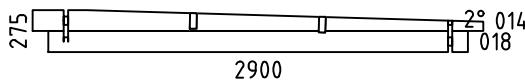



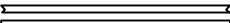

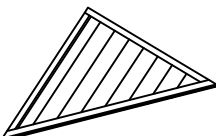

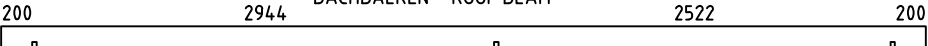
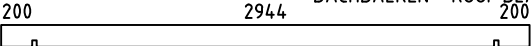
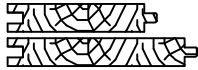

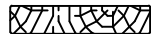
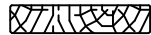



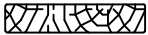
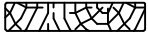
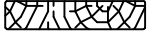

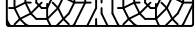
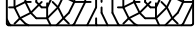

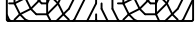
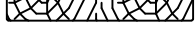
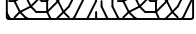

SEITENANSICHT (RECHTS) - SIDE VIEW (RIGHT)







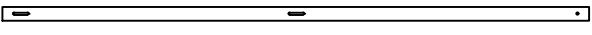
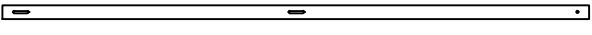

SCALE: NOT TO SCALE

Model	2828780	Seite/Page	11
Zeichnung/Drawing	ANSICHTEN - VIEWS	Maßstab/Scale	1:50
Profil/Profile	28x135	Datum/Date	03.10.2025
Zeichner/Drafter	SRM	File	2828780.dwg

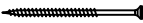
Pos	Bestimmung-Specification 2828780	Stck. Pcs.	Profil Profile (mm)	Länge Length (mm)
EX1	100 4194 100 	1	28x135	4450
003	100 4194 100 	14	28x135	4450
004	100 4194 100 	1	28x68	4450
006	200 2944 200 	1	28x122	3400
007	200 2944 200 	1	28x135	3400
008	3129 100 	1	28x68	3257
009	100 2944 100 	8	28x135	3200
010	200 2944 	1	28x135	3186
011	200 2944 	1	28x71	3186
012	200 2944 	1	28x135	3186
013	100 2944 	7	28x135	3086
015	2522 200 	1	28x71	2764
016	2522 200 	1	28x135	2764
017	2522 200 	1	28x135	2764
019	2522 100 	7	28x135	2664
020	2422 100 	8	28x135	2550
022	100 1938 	1	28x135	2066
023	100 1879 	1	28x135	2007
024		14	28x135	1116
025	100 652 	13	28x135	780
026		13	28x135	652
027	431 100 	14	28x135	559
028		14	28x135	431

Pos	Bestimmung-Specification 2828780		Stck. Pcs.	Profil Profile (mm)	Länge Length (mm)	
029			14	28x135	428	
030			1	28x68	428	
WA-1			1	28x330	4650	
WB-1			1	28x330	4650	
WC-1			1	28x275	2900	
SH	SCHLAGHOLZ - HAMMER BLOCK 28 MM		2	28x135	300	
EE1	TRAUFELEMENTESTÜTZEN - EAVES ELEMENT SUPPORT		4	43x70	200	
EE2	TRAUFELEMENTESTÜTZEN - EAVES ELEMENT SUPPORT		6	43x140	200	
FS1	BEFESTIGUNGSLEISTE - FIXING SLAT		1	70x45	1473	
P1	PFOSTEN - POST	 	1	70x70	2020	
EL	ELEMENTE - ELEMENT		1	48x1008	1008	
BT1	DECKENLEISTEN - COVERING BOARD		2	90x18	2130	
RB1	DACHBALKEN - ROOF BEAM		2	43x140	5950	
RB2	DACHBALKEN - ROOF BEAM		1	43x140	3400	
R-1	DACHBRETT - ROOFBOARD	88mm or-oder 114mm		39+1 30+1	88x18 114x18	4550
R-2	DACHBRETT - ROOFBOARD	88mm or-oder 114mm		29 23	88x18 114x18	2800
EBP2-1	TRAUFELEMENTEBRETTER - EAVES ELEMENTBOARDS		1	18x90	936	
EBP2-2	TRAUFELEMENTEBRETTER - EAVES ELEMENTBOARDS		1	18x90	1732	
EBP2-3	TRAUFELEMENTEBRETTER - EAVES ELEMENTBOARDS		1	18x90	2568	
Model	2828780		Datum/Date	03.10.2025	Seite/Page 2/5	

Pos	Bestimmung-Specification 2828780		Stck. Pcs.	Profil Profile (mm)	Länge Length (mm)
EBP2-4	TRAUFELEMENTEBRETTER - EAVES ELEMENTBOARDS		1	18x90	2900
EBP2-5	TRAUFELEMENTEBRETTER - EAVES ELEMENTBOARDS		1	18x90	3436
EBP2-6	TRAUFELEMENTEBRETTER - EAVES ELEMENTBOARDS		1	18x90	4650
EBP2-7	TRAUFELEMENTEBRETTER - EAVES ELEMENTBOARDS		1	18x90	5050
EBP1-1	TRAUFELEMENTEBRETTER - EAVES ELEMENTBOARDS		2	18x120	936
EBP1-2	TRAUFELEMENTEBRETTER - EAVES ELEMENTBOARDS		2	18x120	1732
EBP1-3	TRAUFELEMENTEBRETTER - EAVES ELEMENTBOARDS		2	18x120	2568
EBP1-4	TRAUFELEMENTEBRETTER - EAVES ELEMENTBOARDS		2	18x120	2900
EBP1-5	TRAUFELEMENTEBRETTER - EAVES ELEMENTBOARDS		2	18x120	3436
EBP1-6	TRAUFELEMENTEBRETTER - EAVES ELEMENTBOARDS		2	18x120	4650
EBP1-7	TRAUFELEMENTEBRETTER - EAVES ELEMENTBOARDS		2	18x120	5050
MB-1	MONTAGEBRETTER - MOUNTIG BOARD		4	40x30	210
MB-2	MONTAGEBRETTER - MOUNTIG BOARD		5	40x30	260
MB-3	MONTAGEBRETTER - MOUNTIG BOARD		9	40x30	330
ES-1	TRAUFELEISTE - EAVES STRIPS		1	30x40	2750
ES-2	TRAUFELEISTE - EAVES STRIPS		1	30x40	3400
ES-3	TRAUFELEISTE - EAVES STRIPS		2	30x40	2975
GS-1	GIEBELDECKLEISTE - GABLE COVER STRIPS		1	18x70	2550
GS-2	GIEBELDECKLEISTE - GABLE COVER STRIPS		1	18x70	3400
AB	VAHEKLOTS 28 SEINALE		4	20x20x15	
SS-1	STURMLEISTE - STORM PROTECTION 		2	18x35	2030
SS-2	STURMLEISTE - STORM PROTECTION 		3	18x35	2180
PRN	REGULIERUNGSSCHRAUBE FÜR PFOSTEN - POST HEIGHT ADJUSTMENT		1		
Model	2828780	Datum/Date	03.10.2025	Seite/Page	3/5

Pos	Bestimmung-Specification 2828780		Stck. Pcs.	Profil Profile (mm)	Länge Length (mm)
HS1	SCHRAUBEN FÜR WANDBOHLLEN BEFESTIGUNG METALLESCREW - SCREWS FOR WALLBEAMS CONNECTING METAL WBM		40	ø3.5x35	
HS34	SCHRAUBEN FÜR TRAUFELEMENTE - SCREWS FOR EAVES ELEMENT / EBP	16		280	Ø4.5x50
	SCHRAUBEN FÜR TRAUFBRETTEN - SCREWS FOR EAVES BOARD / EB	216			
	SCHRAUBEN FÜR TRAUFELEMENTE - SCREWS FOR EAVES STRIPS / ES	36			
	SCHRAUBEN FÜR GIEBELDECKLEISTEN - SCREWS FOR GABLE COVER STRIPS / GS	12			
HS35	SCHRAUBEN FÜR MONTAGEBRETTER - SCREWS FOR MOUNTING BOARD/ MB	24		48	Ø4.5x60
	SCHRAUBEN FÜR PFOSTEN - SCREWS FOR POST / P	2			
	SCHRAUBEN FÜR DECKENLEISTEN - SCREW COVERING BOARD / BT	16			
	SCHRAUBEN FÜR ELEMENT - SCREWS FOR ELEMENTE / EL	6			
HS38	SCHRAUBEN FÜR BLENDENSTÜTZEN - SCREWS FOR PARAPET SUPPORT / EE 20			27	Ø4.5x90
	SCHRAUBEN FÜR ELEMENT - SCREWS FOR ELEMENTE / EL	7			
HS511	SCHRAUBEN FÜR DACHBALKEN - SCREWS FOR ROOF BEAM / RB			20	Ø6x160
	SCHRAUBEN FÜR Pos. - SCREWS FOR Pos. 005,011,015	12	8		
HS52	SCHRAUBEN FÜR REGULIERUNGSSCHRAUBE FÜR PFOSTEN - SCREWS FOR POST HEIGHT ADJUSTMENT / PRN	4		16	Ø6x40
	SCHRAUBEN FÜR STURMLEISTE - SCREWS FOR STORM PROTECTION / SS	12			
NF32	NÄGEL FÜR DACHBRETTEN - NAILS FOR ROOF BOARDS / R			544	Ø2.5x60
KL	DICHTSCHEIBE FÜR STURMLEISTE - WASHER FOR STORM PROTECTION / SS			12	M6x18
WBM1	WANDBOHLLEN BEFESTIGUNG METALLE - WALLBEAMS CONNECTING METAL			10	20x20
Model	2828780	Datum/Date	03.10.2025	Seite/Page	4/5

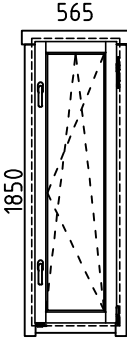
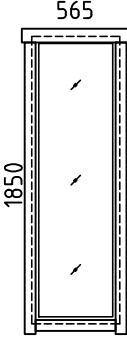
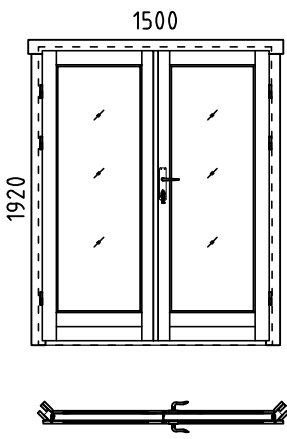
Pos	Bestimmung-Specification 2828780		Stck. Pcs.	Profil Profile (mm)	Länge Length (mm)
AST	FENSTER - WINDOW	DIN RECHTS/RIGHT HANDED	1	565x1850	
					
AST	FENSTER - WINDOW	FESTSTEHEND/FIXED	2	565x1850	
					
AST	TÜR - DOOR	DIN RECHTS/RIGHT HANDED	1	1500x1920	
					
✘	BITTE SELBER ANPASSEN (FALLS NÖTIG)! - CUT INTO LENGTH ON SITE (IF NEEDED)!				
Model	2828780	Datum/Date	03.10.2025	Seite/Page	5/5