







**Gerätehäuser
aus Metall & Kunststoff**

-  Instruction manual
-  Montage handleiding
-  Montageanleitung
-  Manuel d'instruction

Important Information:

Prior to assembling your garden shed, please be aware that assembly may require building permits, depending on the location and surface area. It is crucial to consult with your local authorities to obtain the necessary information before proceeding with the assembly.

Weather Conditions:

We advise you not to use this product as a shelter in extreme weather conditions. In the case of strong winds or snow, we advise locking windows and doors. Subsequently clear any snow on the roof as soon as possible to prevent any damage.

This garden shed is resistant to most weather conditions and can withstand heavy rain. However, exceptional conditions can compromise the water sealing of the product. It is, therefore, deemed acceptable that some water ingress may be possible during certain conditions.

Warranty Information:

The warranty applies to manufacturers defects and covers the replacement of spare parts or the provided product, no refunds will be issued. The manufacturers warranty does not cover:

- Normal wear and tear.
- Loss or breakage during unpacking or installation.
- Lack of care, neglect, vandalism, impact with foreign objects, contact with abrasive materials, aesthetics, incorrect assembly or disassembly, rebuilding, or relocation and including and not limited to all points mentioned in the above weather conditions paragraph.
- Force majeure events like hail, high winds, storms, snow, floods, lightning, etc.
- Modifying the product voids the warranty; user-tampered products are not covered.

All warranty claims must be directed to the point of sale (store or website) where your product was purchased.

Please ensure you send the following details:

- Proof of purchase
- A detailed description of the problem.
- Clear and complete pictures of the problem.

Your claim will then be assessed accordingly.

Product Assembly Guidelines:

- We advise you to read the instructions very carefully before proceeding to assemble the garden shed.
- Carefully select the location, avoiding rainy days, prevailing winds, and overhanging trees. We recommend you also check the surrounding area for any possible obstructions which may be near or within the product placement.
- Mount on a flat and level foundation, preferably on concrete slab or concrete supports along the whole width and length of the flooring profiles.
- Ensure at least 2/3 individuals are present during assembly.
- Keep children away from the assembly area.
- Exercise caution to avoid the risk of pinching.
- Follow all assembly steps meticulously and verify the structure's level on all sides.
- Do not anchor before completing the entire assembly process, we recommend you re-check tightness of all fasteners and the level of the complete shed before doing so.
- Properly anchor the garden shed to the ground or foundation using (expansion)screws and/or plugs.
- To avoid any damages and injuries, please do not climb on the roof.
- Please ensure that you retain the instruction manual and do not throw it away after assembly.
- The user is liable for any damages or injuries caused due to incorrect or improper installation.

Pre-Assembly Checklist:

Before starting the assembly, please ensure:

- All listed parts are supplied and undamaged.
- Report any missing parts within 14 days of delivery AND before assembly!
- For reporting missing parts, please contact your point of sale (store or website) where your product was purchased.
- Do not discard the packaging without confirming the proper functioning of the product.

Maintenance Recommendations:

To ensure longevity and aesthetic appeal, regular maintenance is essential.

We recommend:

- Cleaning with fresh water using a soft sponge or cloth once or twice a year (or more).
- Avoid using detergents or abrasive materials during cleaning.
- Regularly checking the tightness of screws (at least once a year).
- Applying WD-40 (or similar product) to fasteners to clean and increase surface rust resistance
- Ensuring unobstructed water flow in gutters (clearing leaves, branches, etc.).



Belangrijke informatie:

Voordat u uw tuinhuis monteert, dient u zich ervan bewust te zijn dat de bouw mogelijk een bouwvergunning vereist, afhankelijk van de locatie en oppervlakte. Het is cruciaal om voorafgaand aan de montage contact op te nemen met de lokale autoriteiten om de benodigde informatie te verkrijgen.

Weersomstandigheden:

Wij adviseren u om dit product niet als schuilplaats te gebruiken bij extreme weersomstandigheden.

Bij sterke wind of sneeuw adviseren wij om ramen en deuren af te sluiten.

Verwijder vervolgens zo snel mogelijk alle sneeuw van uw pergola om schade te voorkomen.

Deze tuinhuis is bestand tegen de meeste weersomstandigheden en kan zware regenval weerstaan. Uitzonderlijke omstandigheden kunnen echter de waterdichtheid van het product in gevaar brengen. Het wordt daarom aanvaardbaar geacht dat onder bepaalde omstandigheden enige waterindringing mogelijk is.

Garantie-informatie:

De fabrieksgarantie geldt voor fabrieksdefecten en omvangt de vervanging van reserveonderdelen of het geleverde product, er worden geen restituties verstrekt. De fabrieksgarantie dekt niet:

- Normale slijtage.
- Verlies of breuk tijdens het uitpakken of installeren.
- Gebrek aan zorg, verwaarlozing, vandalisme, impact met externe objecten, contact met schurende materialen, esthetiek, onjuiste montage of demontage, herbouw of verplaatsing en inclusief maar niet beperkt tot alle punten genoemd in de bovenstaande alinea over weersomstandigheden.
- Overmachtgebeurtenissen zoals hagel, harde wind, stormen, sneeuw, overstromingen, bliksem, etc.
- Het wijzigen van het product maakt de garantie ongeldig; door de gebruiker gemanipuleerde producten vallen niet onder de dekking.

Alle garantieclaims moeten worden gericht aan het verkooppunt (winkel of website) waar uw product is gekocht.

Zorg ervoor dat u de volgende gegevens meestuurt:

- Aankoopbewijs
- Een gedetailleerde beschrijving van het probleem.
- Duidelijke en volledige foto's van het probleem.

Uw claim wordt dan zorgvuldig beoordeeld.

Product Assemblage Richtlijnen:

- Wij adviseren u om de instructies zeer zorgvuldig te lezen voordat u overgaat tot het monteren van de tuinhuis.
- Selecteer de locatie zorgvuldig, vermijd regenachtige dagen, overheersende winden en overhangende bomen. We raden u ook aan om de omliggende omgeving te controleren op mogelijke obstakels die zich in de buurt van of binnen de plaatsing van het product kunnen bevinden.
- Plaats op een vlakke en egale fundering, bij voorkeur op een betonnen plaat, tegels of gebruik van opsluitbanden onder de gehele breedte en lengte van het product.
- Zorg ervoor dat er minstens 2/3 personen aanwezig zijn tijdens de montage.
- Houd kinderen uit de buurt van het montagegebied.
- Wees voorzichtig om het risico op beknelling te vermijden.
- Volg alle montageschappen nauwgezet en controleer meermalig het waterpas niveau en hoeken van de constructie aan alle zijden tijdens montage.
- Veranker niet voordat het gehele montageproces is voltooid, we raden aan om de stevigheid van alle bevestigingsmiddelen en het niveau van de complete tuinhuis opnieuw te controleren.
- Veranker de tuinhuis op de juiste manier aan de grond of fundering met behulp van (expansie)schroeven en/of pluggen.
- Om schade en letsel te voorkomen, klim niet op het dak.
- Zorg ervoor dat u de instructiehandleiding bewaart en deze niet weggooit na de montage.
- De gebruiker is aansprakelijk voor eventuele schade of letsel veroorzaakt door onjuiste of onjuiste installatie.

Montage voorbereiding/ Controlelijst:

Voordat u met de montage begint, zorg ervoor dat:

- Alle vermelde onderdelen zijn geleverd en onbeschadigd zijn.
- Meld ontbrekende onderdelen binnen 14 dagen na levering EN voor de montage!
- Voor het melden van ontbrekende onderdelen, neem contact op met het verkooppunt (winkel of website) waar uw product is gekocht.
- Gooi de verpakking niet weg zonder de goede werking van het product te bevestigen.

Onderhoudsadviezen:

Om de levensduur en esthetische aantrekkingskracht te waarborgen, is regelmatig onderhoud essentieel.

Wij raden aan:

- Schoon te maken met schoon water, met een zachte spons of doek een- of tweemaal per jaar (of vaker).
- Vermijd het gebruik van reinigingsmiddelen of schurende materialen tijdens het reinigen.
- Controleer regelmatig de stevigheid van schroeven (minstens eenmaal per jaar).
- Het aanbrengen van WD-40 (of een vergelijkbaar product) op bevestigingsmiddelen om ze schoon te maken en de oppervlakeroestbestendigheid te verhogen.
- Zorg voor een onbelemmerde waterafvoer in dakgoten (bladeren, takken, enz. verwijderen).

Wichtige Informationen:

Bevor Sie Ihre Gerätehaus zusammenbauen, beachten Sie bitte, dass je nach Standort und Fläche möglicherweise Baugenehmigungen erforderlich sind. Es ist entscheidend, sich vor dem Zusammenbau mit den örtlichen Behörden zu beraten, um die erforderlichen Informationen zu erhalten.

Wetterbedingungen:

Wir raten Ihnen, dieses Produkt bei extremen Wetterbedingungen nicht als Unterschlupf zu verwenden. Bei starkem Wind oder Schnee empfehlen wir, Fenster und Türen zu schließen. Entfernen Sie dann so schnell wie möglich alle Schnee von Ihrer Pergola, um Schäden zu vermeiden.

Diese Gerätehaus ist gegen die meisten Wetterbedingungen beständig und kann starken Regen standhalten. Allerdings können außergewöhnliche Umstände die Wasserdichtigkeit des Produkts beeinträchtigen. Es wird daher als akzeptabel angesehen, dass unter bestimmten Umständen etwas Wasser eindringen kann.

Garantieinformationen:

Die Herstellergarantie gilt für Fabrikmäängel und umfasst den Ersatz von Ersatzteilen oder der gelieferten Produkt ab, keine Rückerstattungen werden gewährt. Die Herstellergarantie deckt nicht:

- Normale Abnutzung.
- Verlust oder Bruch während des Auspackens oder der Installation.
- Mangelnde Pflege, Vernachlässigung, Vandalismus, Aufprall mit Fremdkörpern, Kontakt mit abrasiven Materialien, ästhetische Probleme, falsche Montage oder Demontage, Wiederaufbau oder Verschiebung und einschließlich, jedoch nicht beschränkt auf alle Punkte, die im obigen Abschnitt zu den Wetterbedingungen genannt werden.
- Höhere Gewalt wie Hagel, starke Winde, Stürme, Schnee, Überschwemmungen, Blitz usw.
- Eine Änderung des Produkts führt zum Erlöschen der Garantie; vom Benutzer manipulierte Produkte sind nicht abgedeckt.

Alle Garantieansprüche müssen an den Verkaufspunkt (Geschäft oder Website) gerichtet werden, wo Ihr Produkt gekauft wurde. Stellen Sie sicher, dass Sie die folgenden Informationen angeben:

- Kaufbeleg
- Eine detaillierte Beschreibung des Problems.
- Klare und vollständige Fotos des Problems.

Anschließend wird Ihr Garantie Reklamation sorgfältig geprüft.

Montagerichtlinien für das Produkt:

- Wir empfehlen Ihnen, die Anleitung sorgfältig zu lesen, bevor Sie mit dem Aufbau des Gerätehaus beginnen.
- Wählen Sie den Standort sorgfältig aus und vermeiden Sie Regentage, vorherrschende Winde und überhängende Bäume. Wir empfehlen Ihnen außerdem, die Umgebung auf mögliche Hindernisse in der Nähe oder innerhalb der Produktplatzierung zu überprüfen.
- Legen Sie auf einem flachen und ebenen Untergrund, vorzugsweise auf einer Betonplatte, Fliesen oder verwenden Sie Rasenkantenstein unter der gesamten Breite und Länge des Produkts.
- Stellen Sie sicher, dass bei der Installation mindestens 2/3 Personen anwesend sind.
- Halten Sie Kinder vom Montagebereich fern.
- Achten Sie darauf, Quetschgefahr zu vermeiden.
- Befolgen Sie alle Montageschritte sorgfältig und überprüfen Sie während der Montage mehrmals die Höhe und Winkel der Konstruktion auf allen Seiten.
- Verankern Sie erst, nachdem der gesamte Installationsvorgang abgeschlossen ist. Wir empfehlen, den festen Sitz aller Befestigungselemente und die Höhe der gesamten Gerätehaus erneut zu überprüfen.
- Verankern Sie das Gerätehaus mit Bolzenanker, Schrauben und/oder Dübeln fachgerecht im Boden oder Fundament.
- Um Schäden und Verletzungen zu vermeiden, klettern Sie nicht auf das Dach.
- Bewahren Sie die Bedienungsanleitung unbedingt und werfen Sie sie nach der Installation nicht weg.
- Der Benutzer haftet für Schäden oder Verletzungen, die durch eine fehlerhafte oder fehlerhafte Installation verursacht werden.

Vor-Montage-Checkliste:

Bevor Sie mit der Montage beginnen, stellen Sie bitte sicher:

- Alle aufgeführten Teile sind vorhanden und unbeschädigt.
- Melden Sie fehlende Teile innerhalb von 14 Tagen nach Lieferung UND vor der Montage!
- Für die Meldung fehlender Teile wenden Sie sich bitte an den Verkaufspunkt (Geschäft oder Website), an dem Ihr Produkt gekauft wurde.
- Werfen Sie die Verpackung nicht weg, ohne die ordnungsgemäße Funktion des Produkts zu bestätigen.

Wartungsempfehlungen:

Um Langlebigkeit und ästhetischen Reiz sicherzustellen, ist regelmäßige Wartung unerlässlich.

Wir empfehlen:

- Ein- oder zweimal im Jahr (oder öfter) mit klarem Wasser und einem weichen Schwamm oder Tuch zu reinigen.
- Verwenden Sie während der Reinigung keine Reinigungsmittel oder abrasive Materialien.
- Überprüfen Sie regelmäßig die Festigkeit der Schrauben (mindestens einmal im Jahr).
- Tragen Sie WD-40 (oder ein ähnliches Produkt) auf die Befestigungen auf, um sie zu reinigen und die Oberflächenrostbeständigkeit zu erhöhen.
- Stellen Sie sicher, dass das Regenwasser in den Regenrinnen ungehindert fließen kann (entfernen Sie Blätter, Äste usw.).



Informations importantes:

Avant d'assembler votre abri de jardin, sachez que la construction peut nécessiter des permis de construire, en fonction de l'endroit et de la surface. Il est essentiel de consulter les autorités locales pour obtenir les informations nécessaires avant de procéder à l'assemblage.

Conditions météorologiques:

Nous vous déconseillons d'utiliser ce produit comme abri dans des conditions climatiques extrêmes. En cas de vent fort ou de neige, nous vous recommandons de fermer les fenêtres et les portes. Retirez ensuite toute la neige de votre pergola le plus rapidement possible pour éviter tout dommage.

Cet abri de jardin peut résister à la plupart des conditions météorologiques et aux fortes pluies. Toutefois, des circonstances exceptionnelles peuvent compromettre l'étanchéité du produit. Il est donc considéré comme acceptable qu'une certaine infiltration d'eau soit possible dans certaines circonstances.

Informations sur la garantie:

La garantie constructeur s'applique aux défauts de fabrication et couvre le remplacement des pièces détachées ou des produit fourni ; aucun remboursement ne sera effectué. La garantie du fabricant ne couvre pas :

- L'usage normale.
- Perte ou casse lors du déballage ou de l'installation.
- Manque d'entretien, négligence, vandalisme, choc avec des objets externe, contact avec des matériaux abrasifs, esthétique, montage ou démontage incorrect, reconstruction ou déplacement, y compris, tous les points mentionnés dans le paragraphe ci-dessus relatif aux conditions météorologiques.
- Les événements de force majeure tels que la grêle, les vents violents, les tempêtes, la neige, les inondations, la foudre, etc.
- La modification du produit annule la garantie ; les produits altérés par l'utilisateur ne sont pas couverts.

Toutes les demandes de garantie doivent être adressées au point de vente (magasin ou site web) où votre produit a été acheté. Assurez-vous d'inclure les informations suivantes :

- Preuve d'achat
- Une description détaillée du problème.
- Photos claires et complètes du problème.

Votre réclamation sera ensuite soigneusement évaluée.

Directives d'assemblage du produit:

- Nous vous conseillons de lire très attentivement les instructions avant de procéder au montage de l'abri de jardin.
- Choisissez soigneusement l'emplacement, en évitant les jours de pluie, les vents dominants et les arbres en surplomb. Nous vous recommandons également de vérifier la zone environnante pour voir s'il n'y a pas d'obstacles qui pourraient se trouver à proximité ou à l'intérieur de l'emplacement du produit.
- Sur une fondation plane et de niveau, de préférence sur une dalle en béton, poser des dalles ou utiliser des sangles de maintien sous toute la largeur et la longueur du produit.
- Assurez-vous qu'au moins 2/3 personnes soient présentes pendant le montage.
- Tenez les enfants à l'écart de la zone de montage.
- Attention à éviter tout risque d'écrasement.
- Suivez attentivement toutes les étapes de montage et vérifiez plusieurs fois le niveau et les angles de la constructions de tous les côtés pendant le montage.
- Ne pas ancrer tant que tout le processus d'assemblage n'est pas terminé, nous vous recommandons de revérifier le serrage de toutes les fixations et le niveau de l'abri de jardin complet.
- Ancrez correctement l'abri de jardin au sol ou aux fondations à l'aide de vis (à expansion) et/ou de chevilles.
- Pour éviter tout dommage ou blessure, ne montez pas sur le toit.
- Pour toute référence future et pour l'entretien, veillez à conserver le manuel d'instructions et à ne pas le jeter après l'assemblage
- L'utilisateur est responsable de tout dommage ou blessure causé par un assemblage et/ou une installation incorrects.

Préparation de l'assemblage/ Liste de controle:

Avant de commencer l'assemblage, veuillez vous assurer que:

- Toutes les pièces énumérées sont fournies et intactes.
- Signalez toute pièce manquante dans les 14 jours dès réception de votre commande ET avant l'assemblage !
- Pour signaler les pièces manquantes, veuillez envoyer un mail au point de vente (magasin ou site web) où votre produit a été acheté.
- Ne jetez pas l'emballage sans avoir confirmé le bon fonctionnement du produit.

Recommandations d'entretien:

Pour garantir la longévité et l'attrait esthétique, un entretien régulier est essentiel.

Nous recommandons :

- Nettoyer à l'eau claire, à l'aide d'une éponge ou d'un chiffon doux, une à deux fois par an (ou plus souvent).
- Éviter d'utiliser des détergents ou des matériaux abrasifs lors du nettoyage.
- Vérifier régulièrement le serrage des vis (au moins une fois par an).
- Appliquer du WD-40 (ou un produit similaire) sur les fixations pour les nettoyer et augmenter la résistance à la rouille en surface.
- Assurez que l'eau s'écoule librement dans les gouttières (enlevez les feuilles, les branches, etc.).

Required equipment/ Benodigde materialen/ Benötigte Ausrüstung/
Équipement requis

Tools/ Gereedschap/Werkzeug/ Outils:

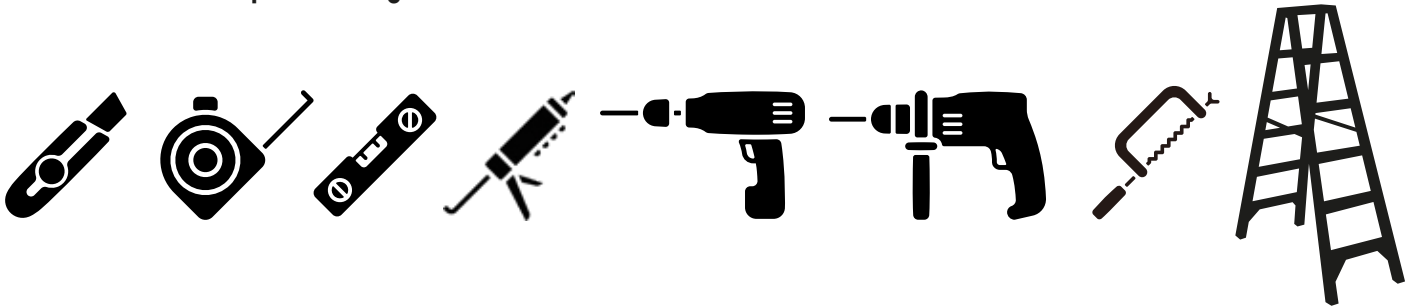

PPE/ PB/ PSA/ EPI:



GHF23256

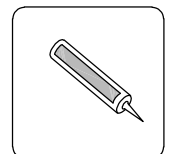
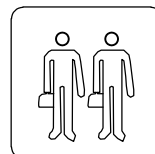
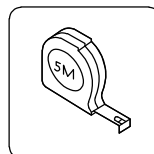
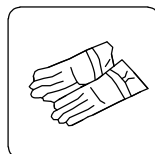
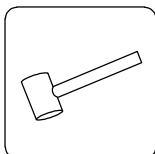
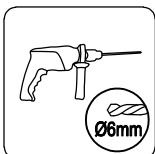
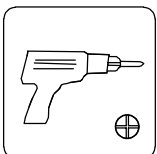
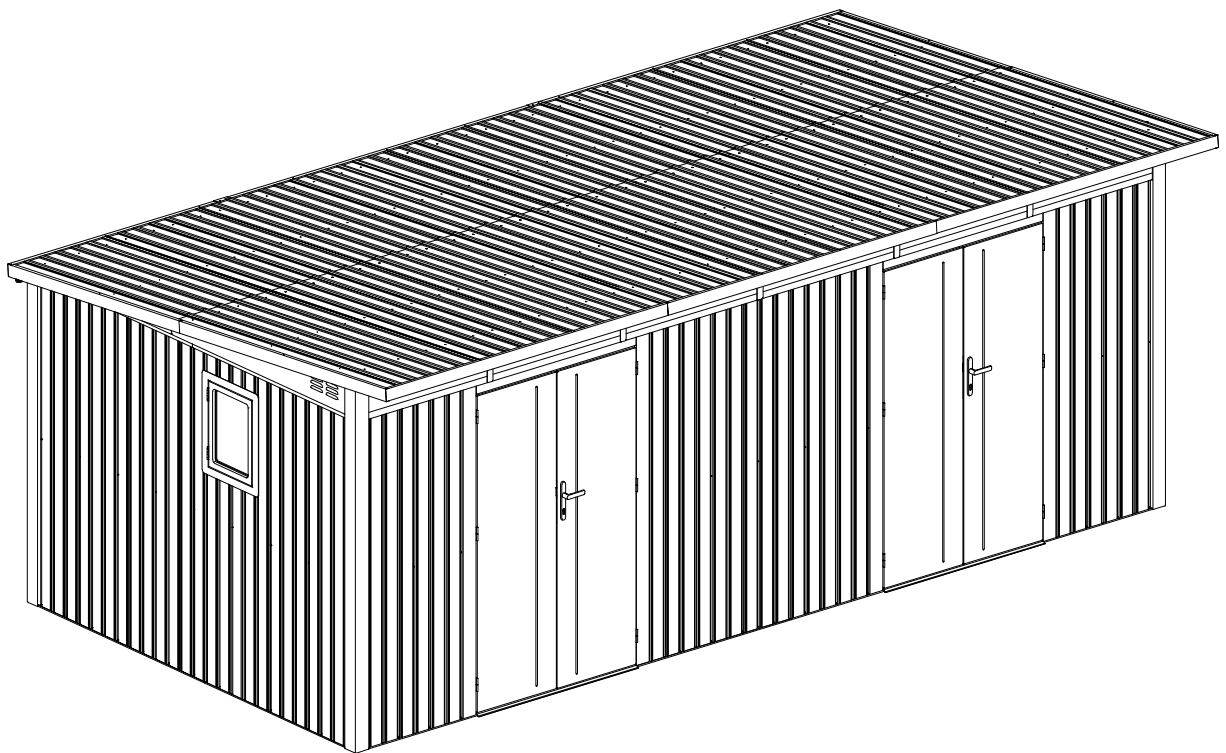

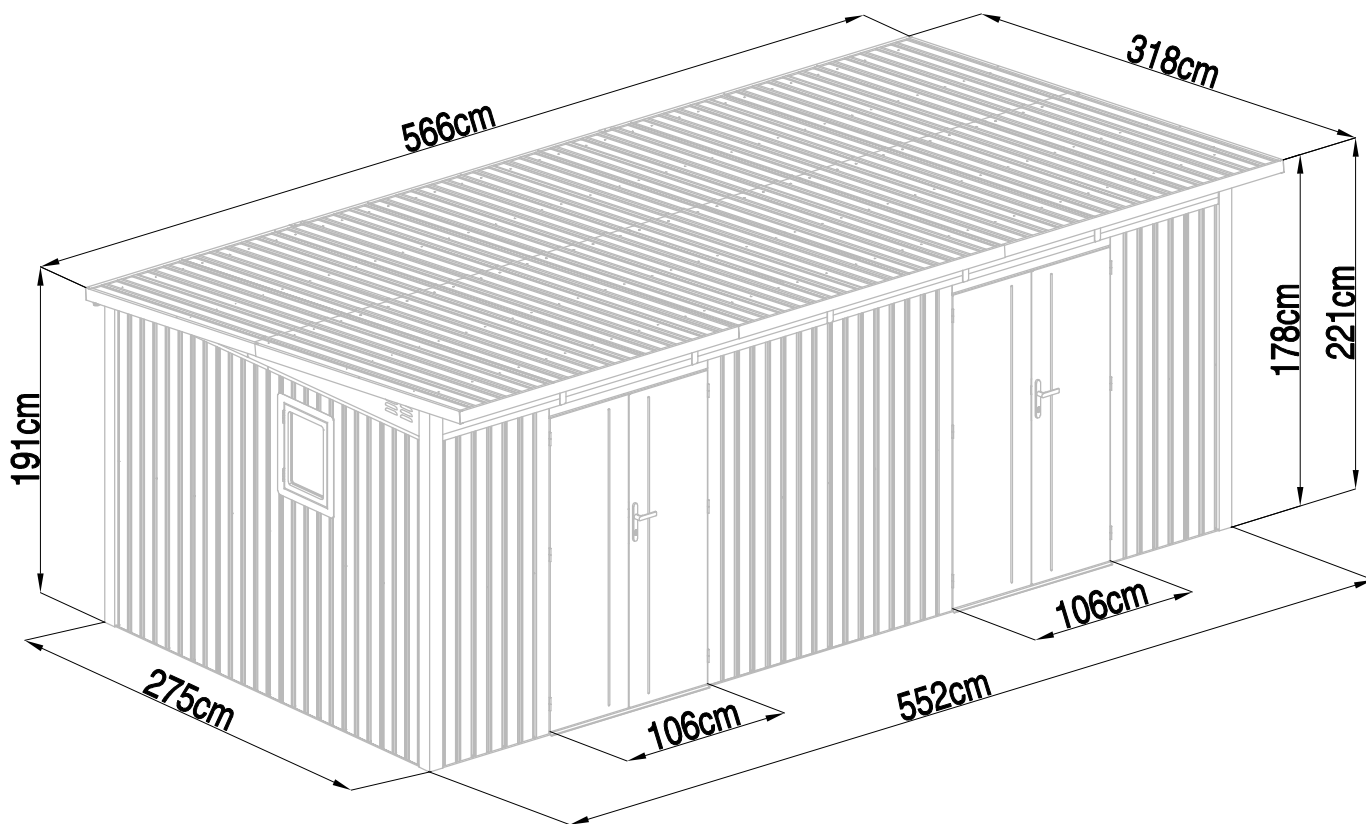



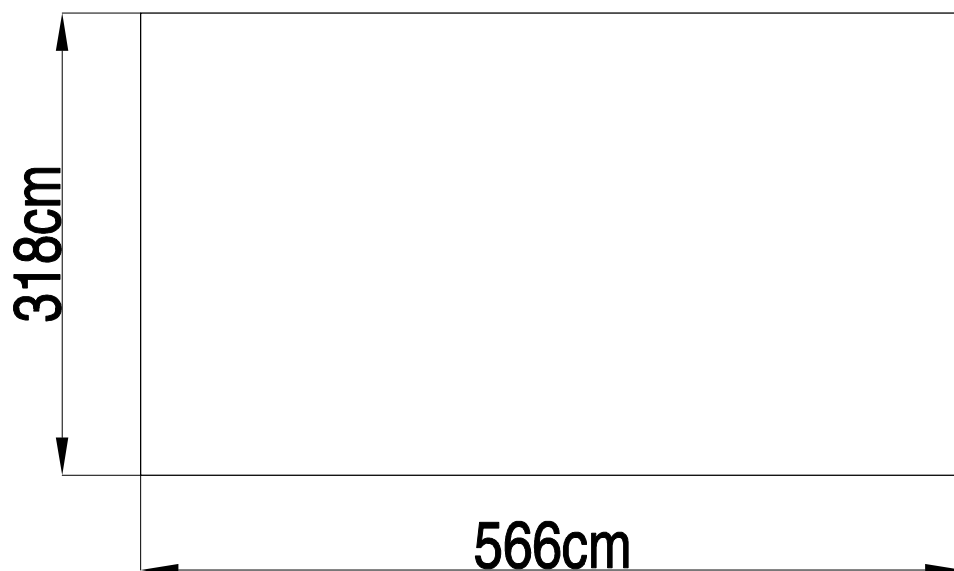

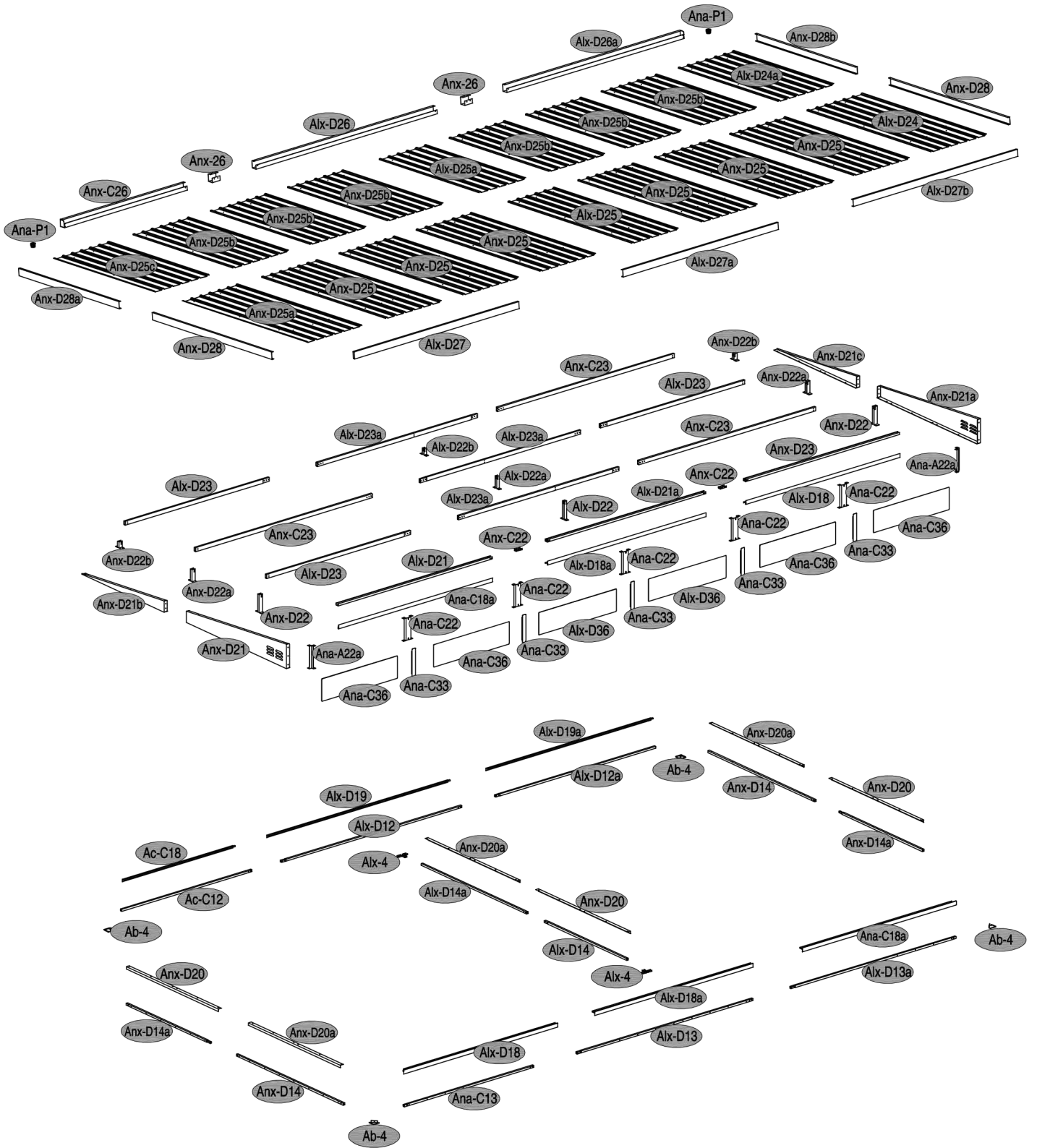

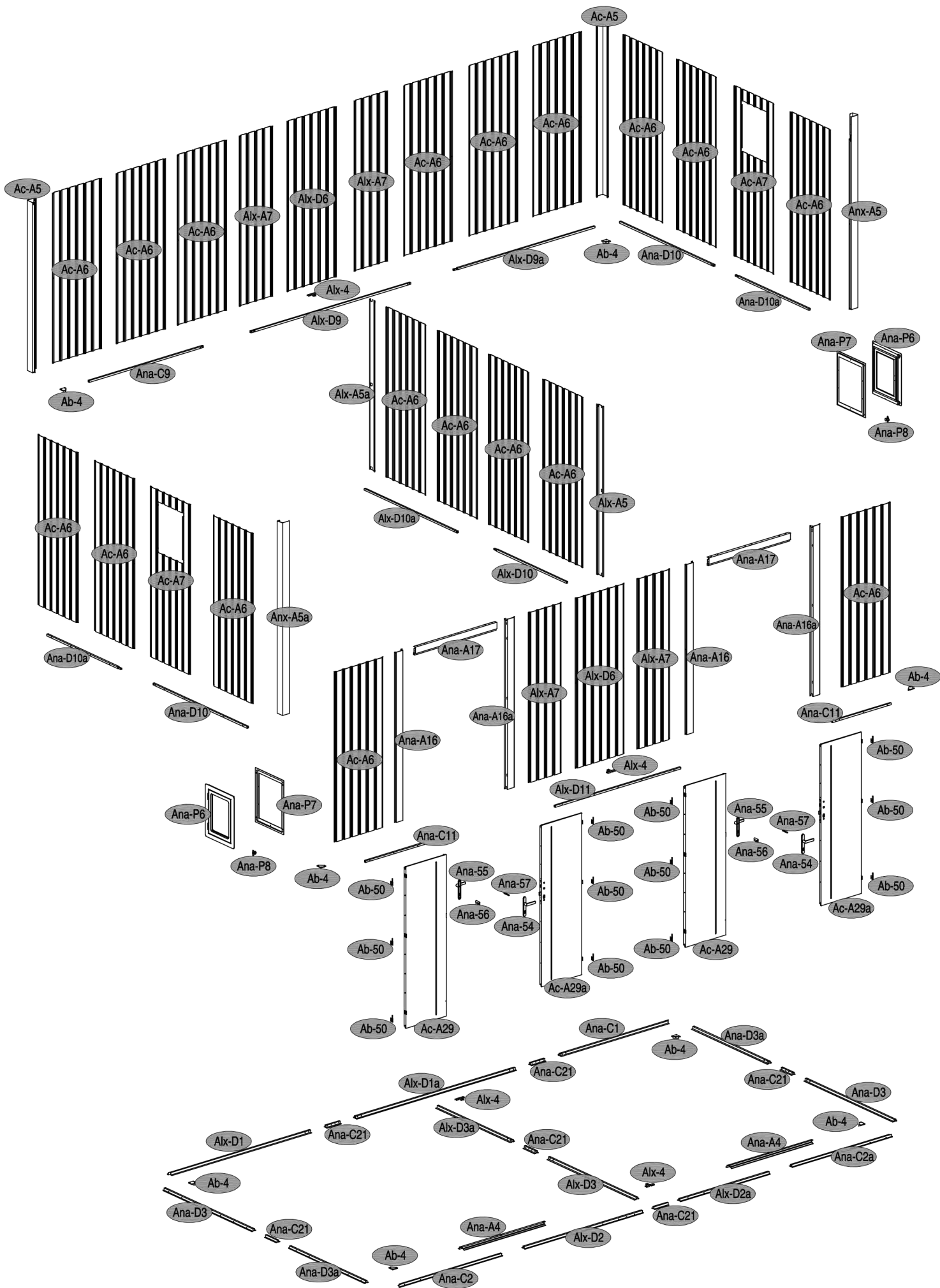

Area of installation requirement:











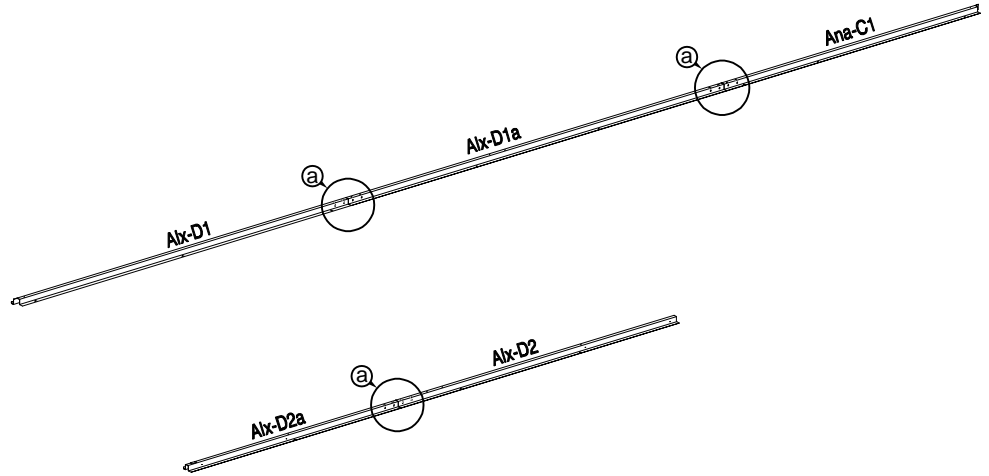
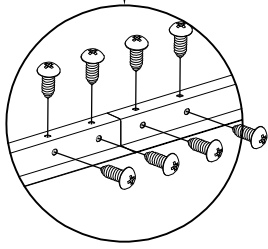
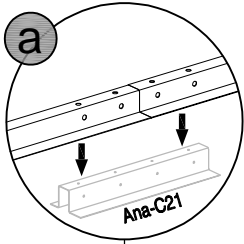





NO.	IMAGE	mm	QTY	NO.	IMAGE	mm	QTY	
UNDER								
Ana-C1		1458	x1	Alx-D14		1191.5	x1	
Alx-D1		1884	x1	Alx-D14a		1521.5	x1	
Alx-D1a		2130	x1	Ana-A16		1900	x2	
Ana-C2		1371.5	x1	Ana-A16a		1900	x2	
Ana-C2a		1331.5	x1	Ana-A17		1087.5	x2	
Alx-D2		1577.5	x1	Ana-C18a		1811.5	x2	
Alx-D2a		1191.5	x1	Alx-D18		1811.5	x2	
Ana-D3		1458	x2	Alx-D18a		1862	x2	
Ana-D3a		1245	x2	Ac-C18		1299.5	x1	
Alx-D3		1438	x1	Alx-D19		2129.5	x1	
Alx-D3a		1225	x1	Alx-D19a		1938.5	x1	
Ana-A4			1130	x2	Anx-D20		1329	x3
MIDDLE				Anx-D20a	1329		x3	
Ac-A5		1900	x2	Anx-D21		1447	x1	
Anx-A5		2152	x1	Anx-D21a		1447	x1	
Anx-A5a		2152	x1	Anx-D21b		1190	x1	
Alx-A5		1900	x1	Anx-D21c		1190	x1	
Alx-A5a		1900	x1	Ana-C21		190	x6	
Ac-A6		1900	x18	Ana-C22		223	x5	
Alx-D6		1900	x2	Ana-A22a		223	x2	
Ac-A7		1900	x2	Anx-D22		179	x2	
Alx-A7	1900	x4	Anx-D22a	120		x2		
Ana-C9		1521.5	x1	Anx-D22b		62	x2	
Alx-D9		2129	x1	Alx-D22		181	x1	
Alx-D9a		1881.5	x1	Alx-D22a		122	x1	
Ana-D10		1541	x2	Alx-D22b		64	x1	
Ana-D10a		1211	x2	Anx-C22		70	x2	
Alx-D10		1191.5	x1	Anx-C23		2079.5	x3	
Alx-D10a		1521.5	x1	Alx-D23		1695.5	x3	
Ana-C11		783.5	x2	Alx-D23a		1885.5	x3	
Alx-D11		1673	x1	Alx-D21		1812	x1	
Ac-C12		1531.5	x1	Alx-D21a		1861	x1	
Alx-D12		2119	x1	Anx-D23		1812	x1	
Alx-D12a		1881.5	x1	Ana-C33		272	x5	
Ana-C13		1521.5	x1	Ana-C36		890	x4	
Alx-D13		2069	x1	Alx-D36		914	x2	
Alx-D13a	1941.5	x1	DOOR					
Anx-D14	1541	x2	Ac-A29		1804	x2		
Anx-D14a	1211	x2	Ac-A29a		1804	x2		

1	 Ana-C1 x1	 Alx-D1 x1	 Alx-D1a x1	 Alx-D2 x1	 Alx-D2a x1	 Ana-C21 x3	 Alx-D41 x24	
----------	--	--	---	--	---	---	--	--

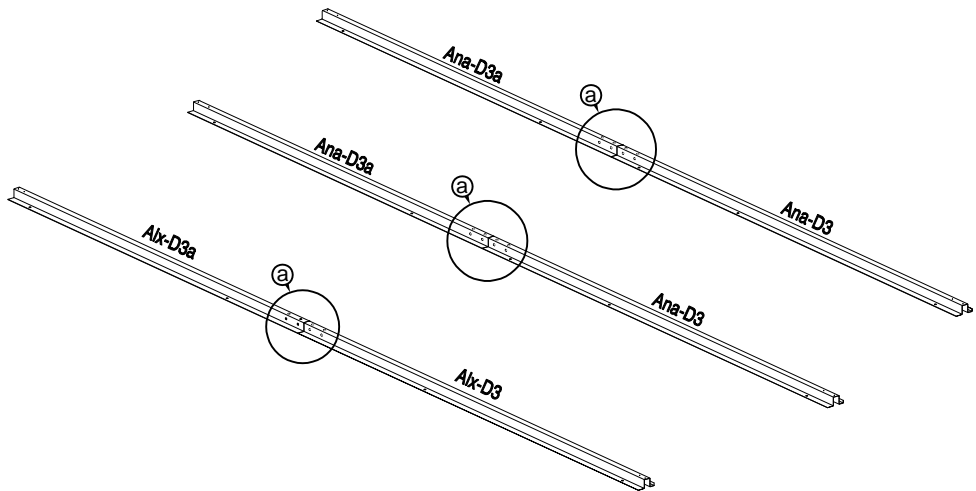
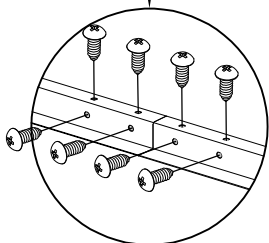
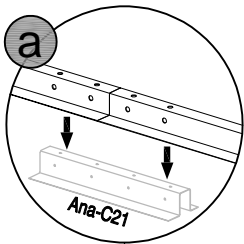

2	 Ana-D3 x2	 Ana-D3a x2	 Alx-D3 x1	 Alx-D3a x1	 Ana-C21 x3	 Alx-D41 x24	
----------	--	---	--	--	---	--	--

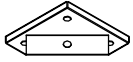

3	 Ana-C2 x1	 Ana-C2a x1	 Ab-4 x4	 Ana-A4 x2	 A1x-D41 x20	
---	--	---	--	---	--	--

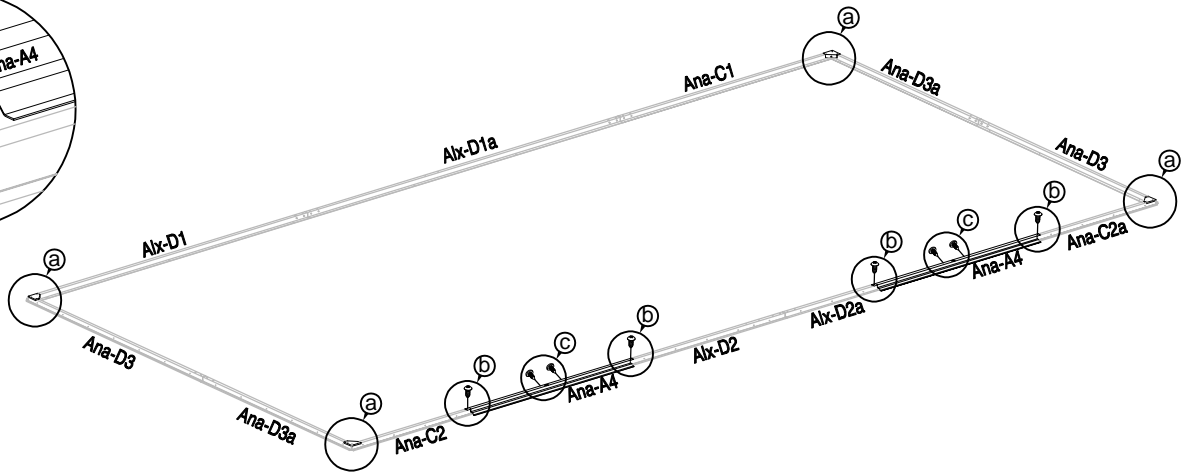
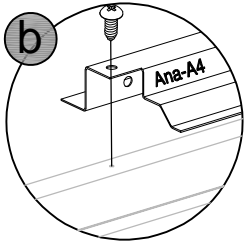
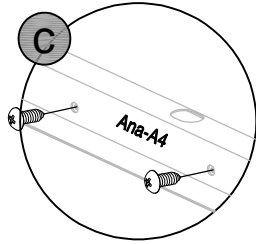
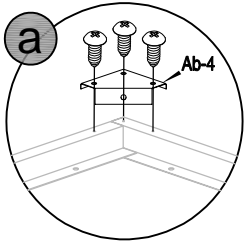

4	 A1x-4 x2	 A1x-D41 x6	
---	---	---	--

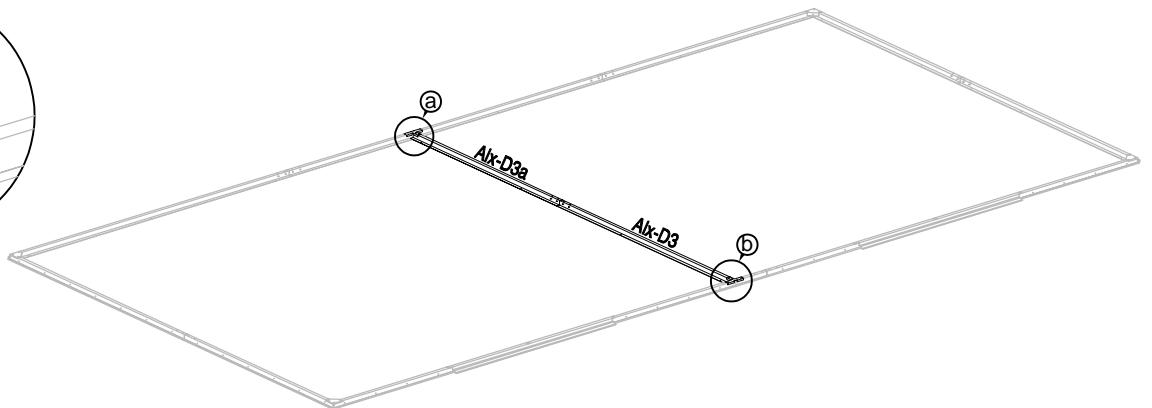
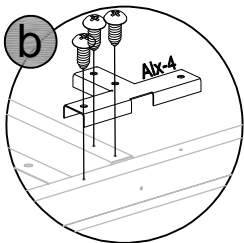
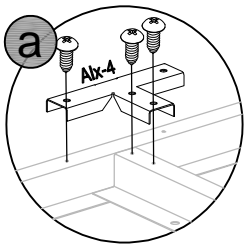

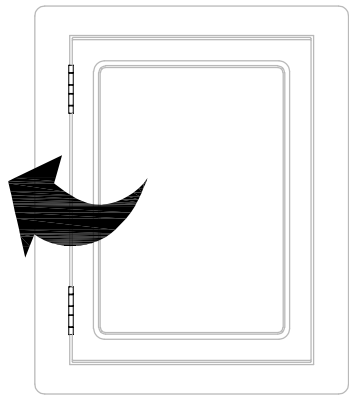



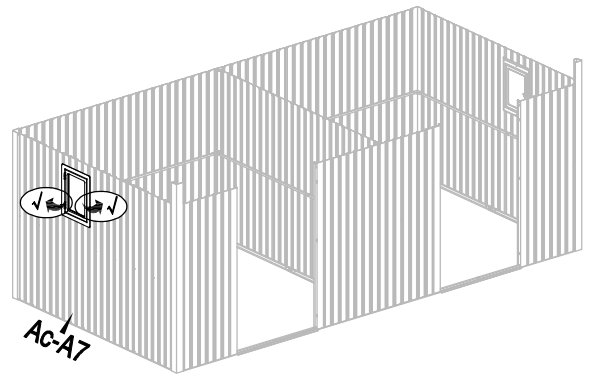
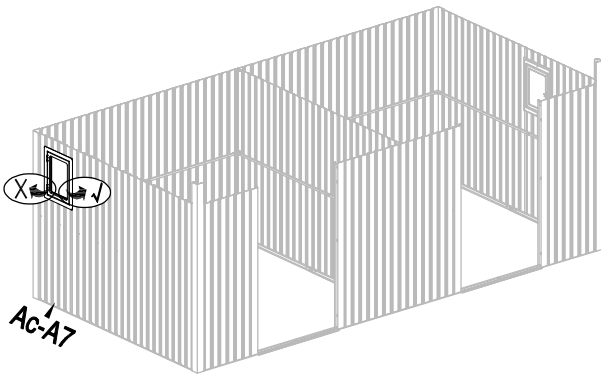
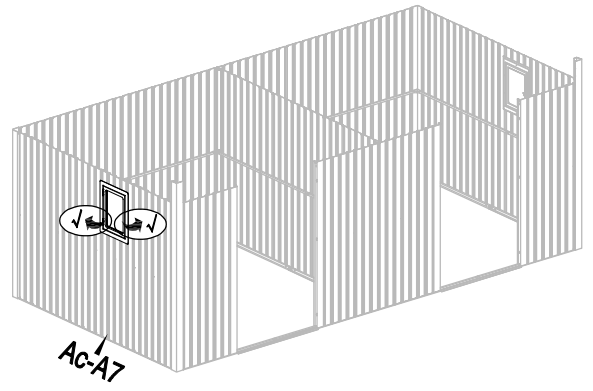
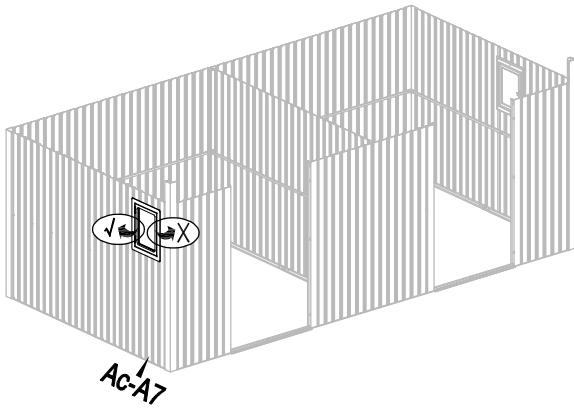
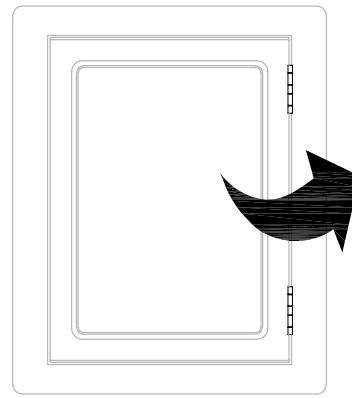

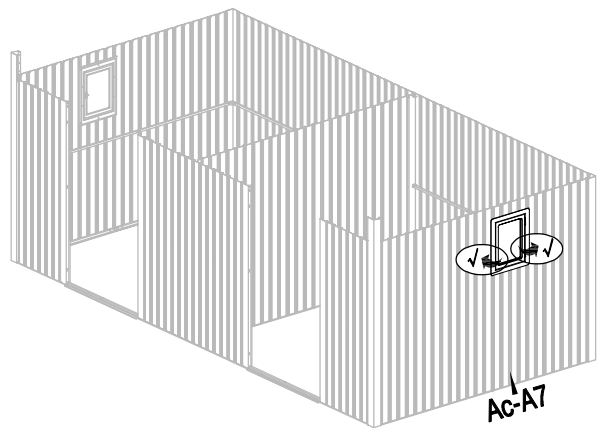
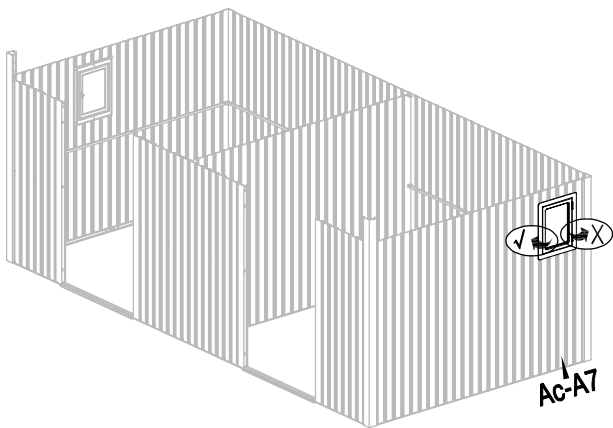
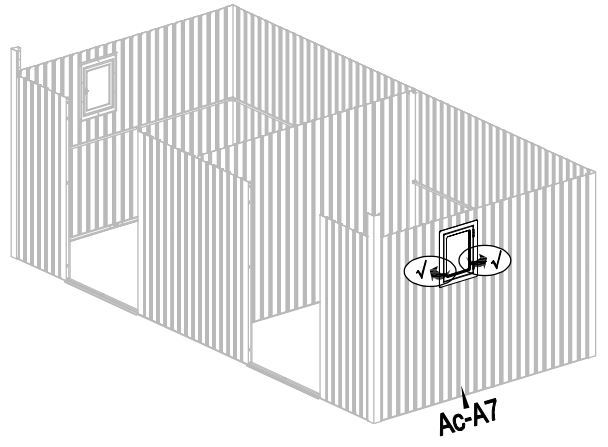
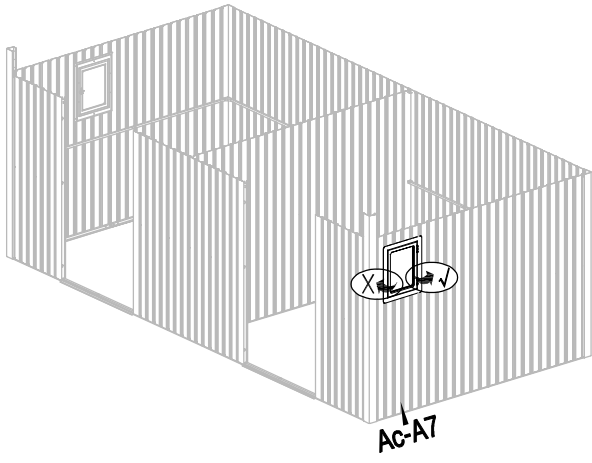

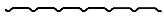

Or



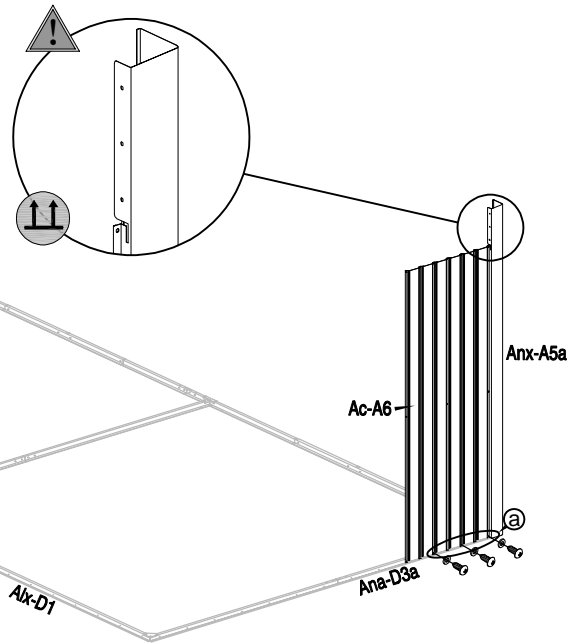
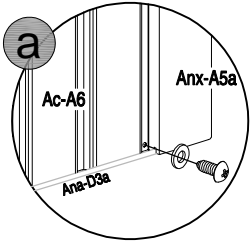
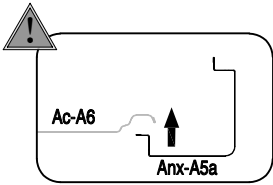





5	 Ac-A6 x1	 Anx-A5a x1	 Alx-D41 x3	 Alx-D40 x3	
---	---	---	---	--	--

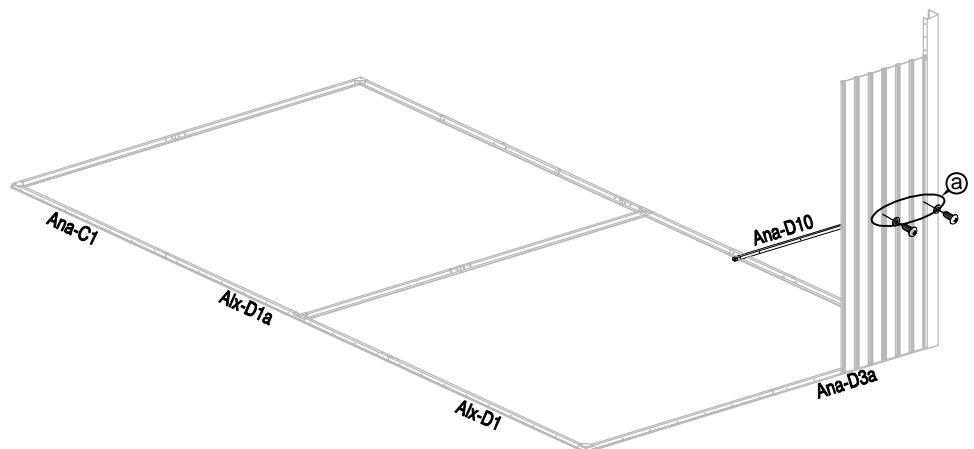
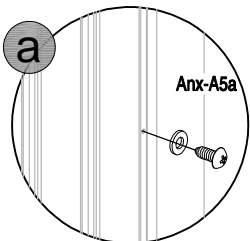
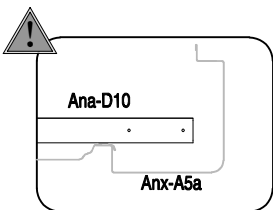

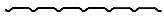
6	 Ana-D10 x1	 Alx-D41 x2	 Alx-D40 x2	
---	---	---	---	--



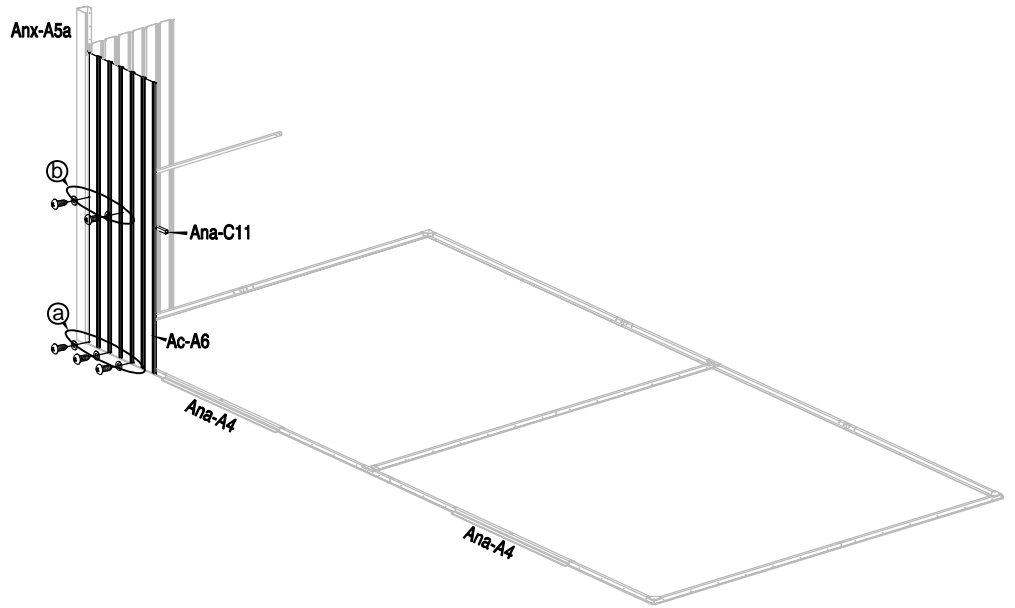
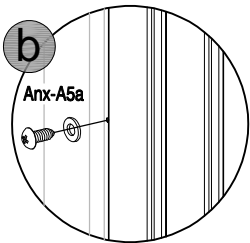
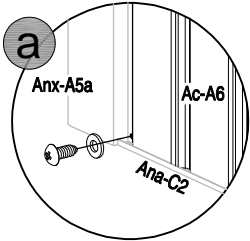
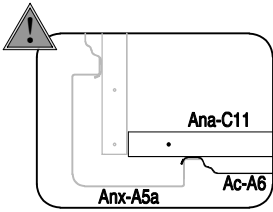

7	 Ac-A6 x1	 Ana-C11 x1	 Alx-D41 x5	 Alx-D40 x5	
---	---	---	---	--	--

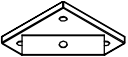

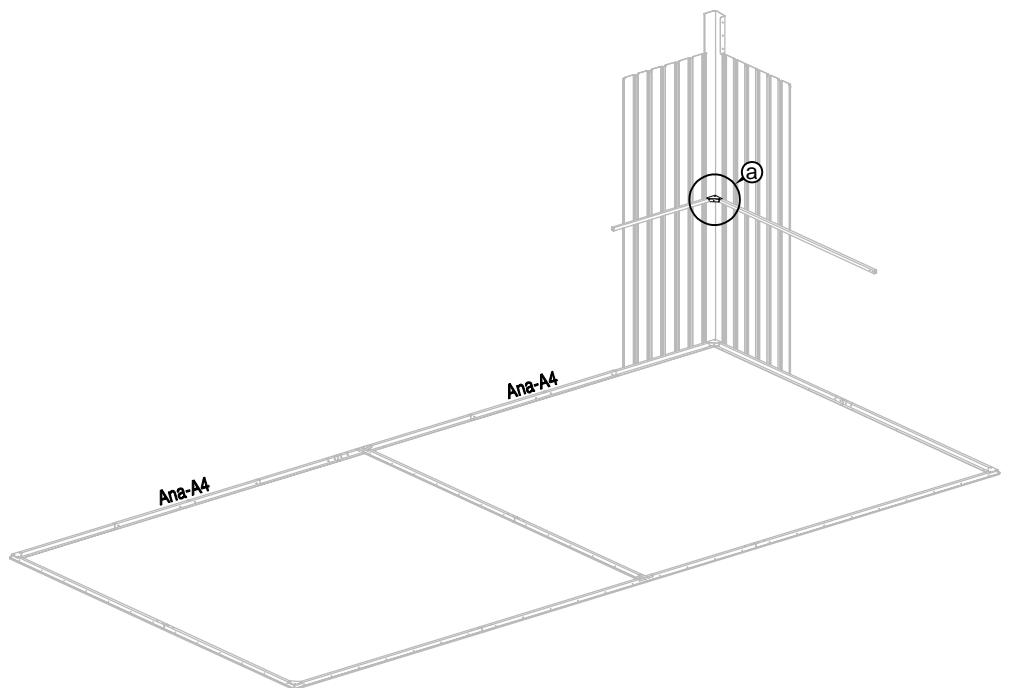
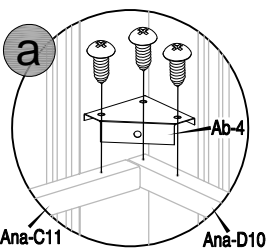
8	 Ab-4 x1	 Alx-D41 x3	
---	--	---	--

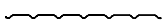

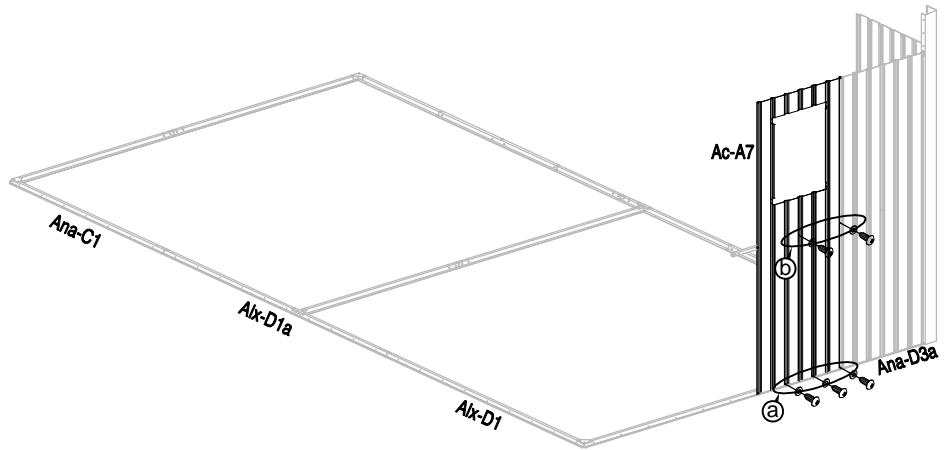
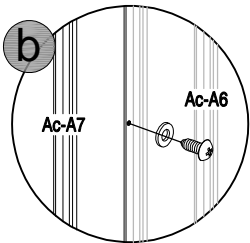
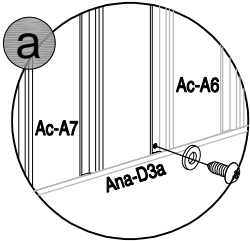
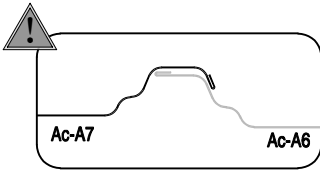

9	 Ac-A7 x1	 Alx-D41 x5	 Alx-D40 x5	
---	---	---	---	--



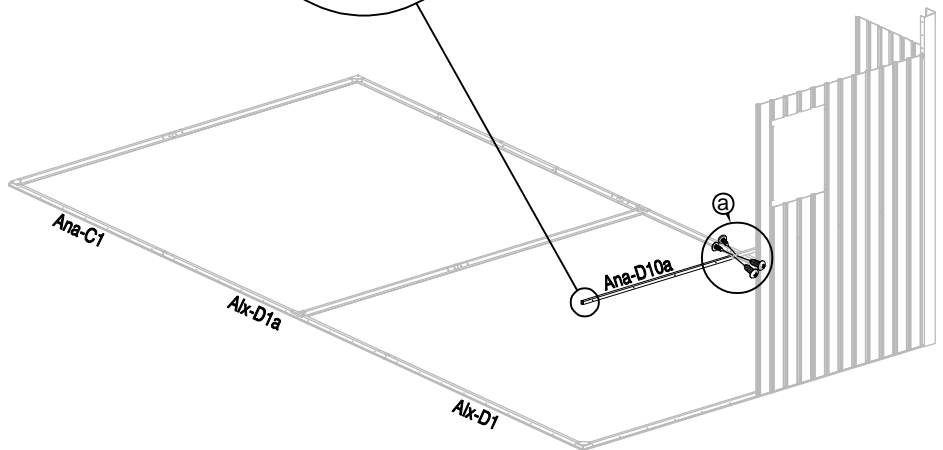
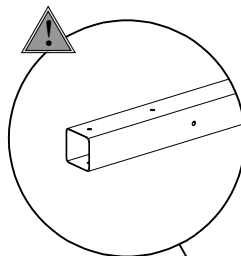
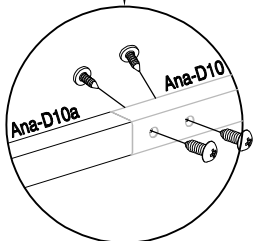
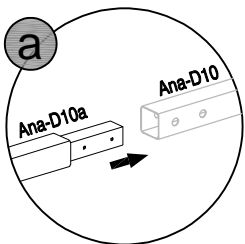

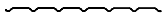
10	 Ana-D10a x1	 Alx-D41 x4	
----	--	---	--



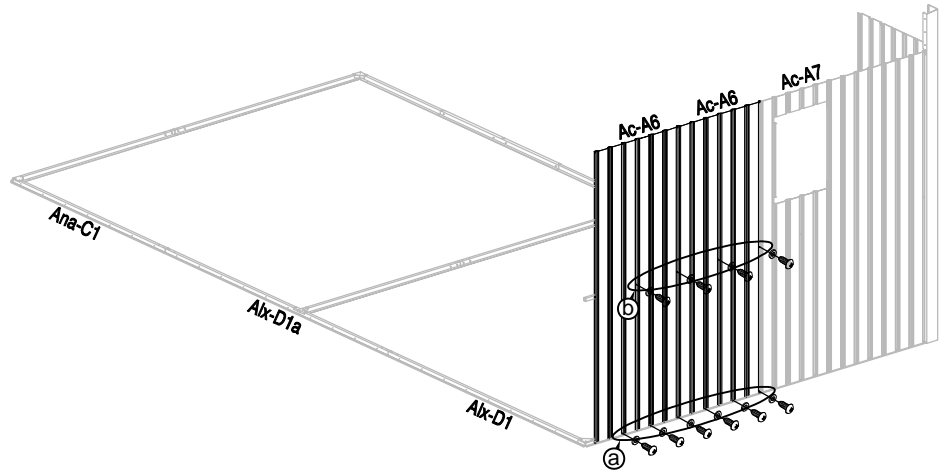
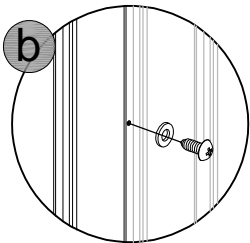
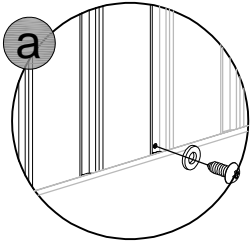
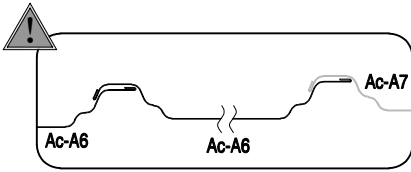



11	 Ac-A6 x2	 Alx-D41 x10	 Alx-D40 x10	
----	---	--	--	--

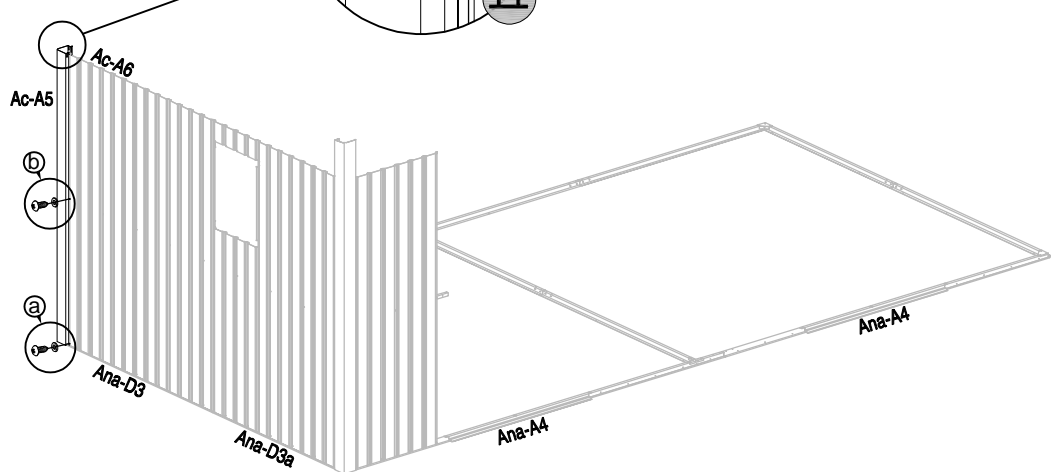
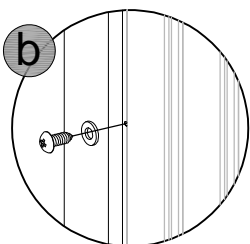
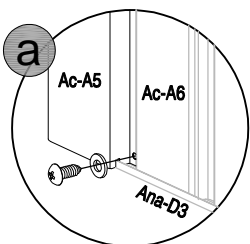
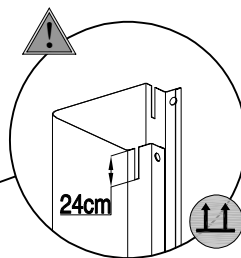
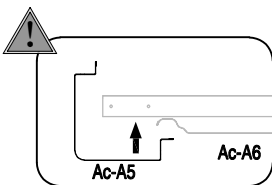

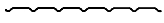
12	 Ac-A5 x1	 Alx-D41 x2	 Alx-D40 x2	
----	---	---	---	--



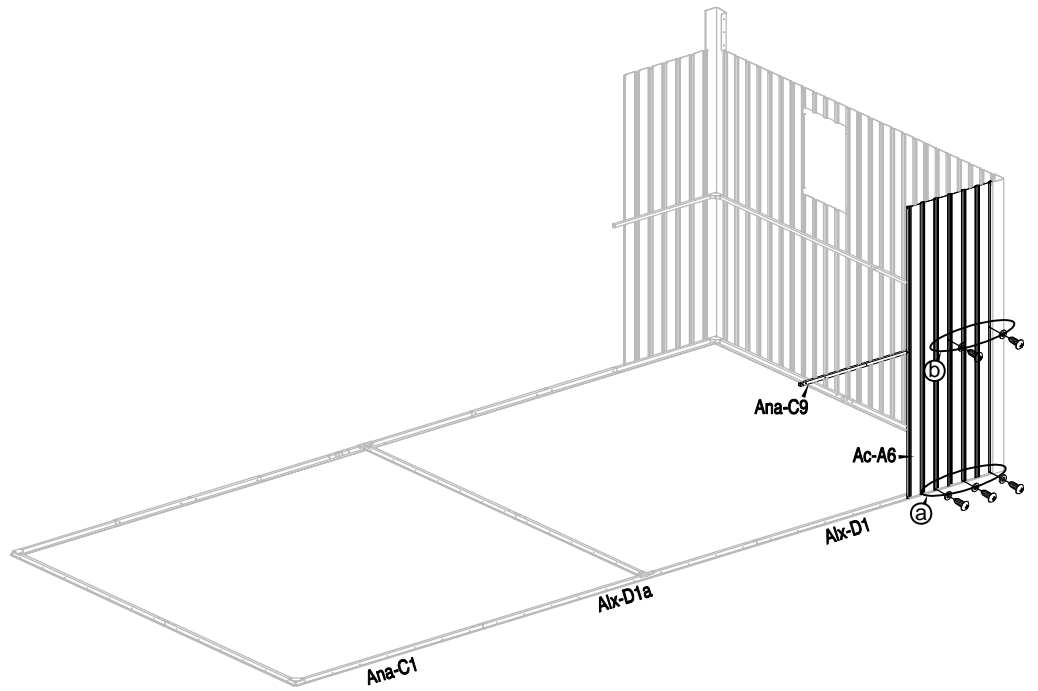
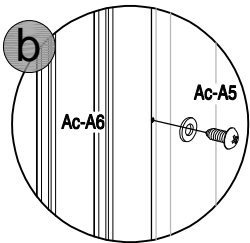
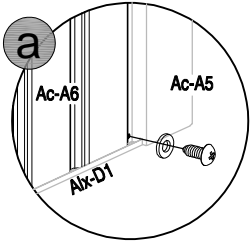
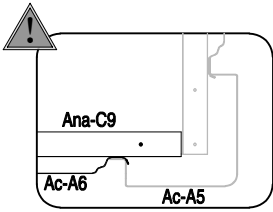

13	 Ac-A6 x1	 Ana-C9 x1	 Alx-D41 x5	 Alx-D40 x5	
----	---	--	---	--	--

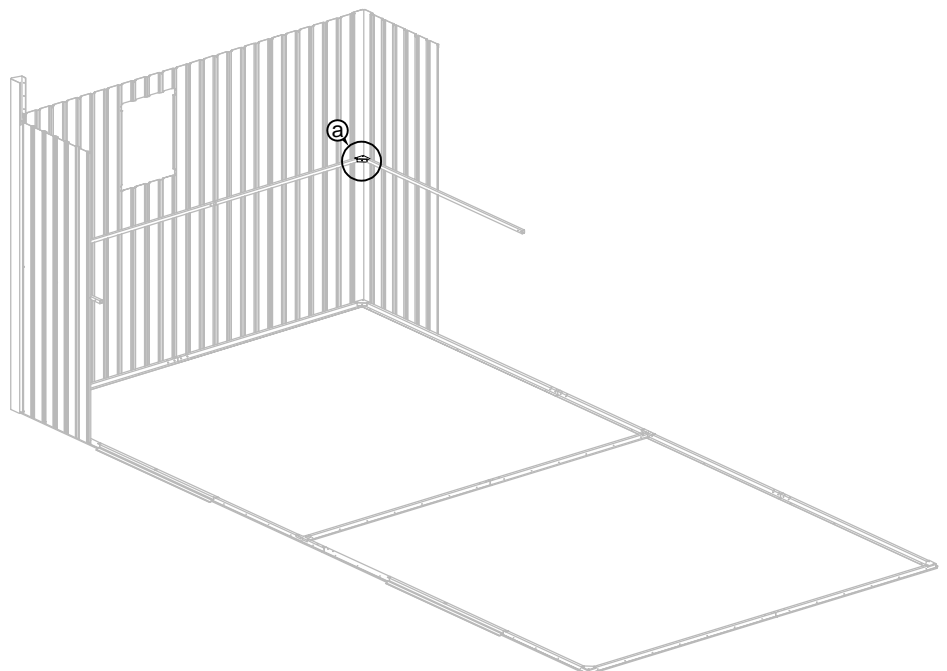
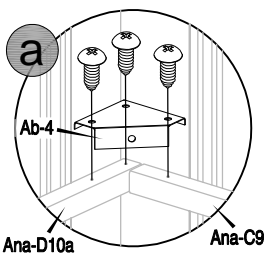

14	 Ab-4 x1	 Alx-D41 x3	
----	--	---	--

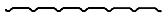

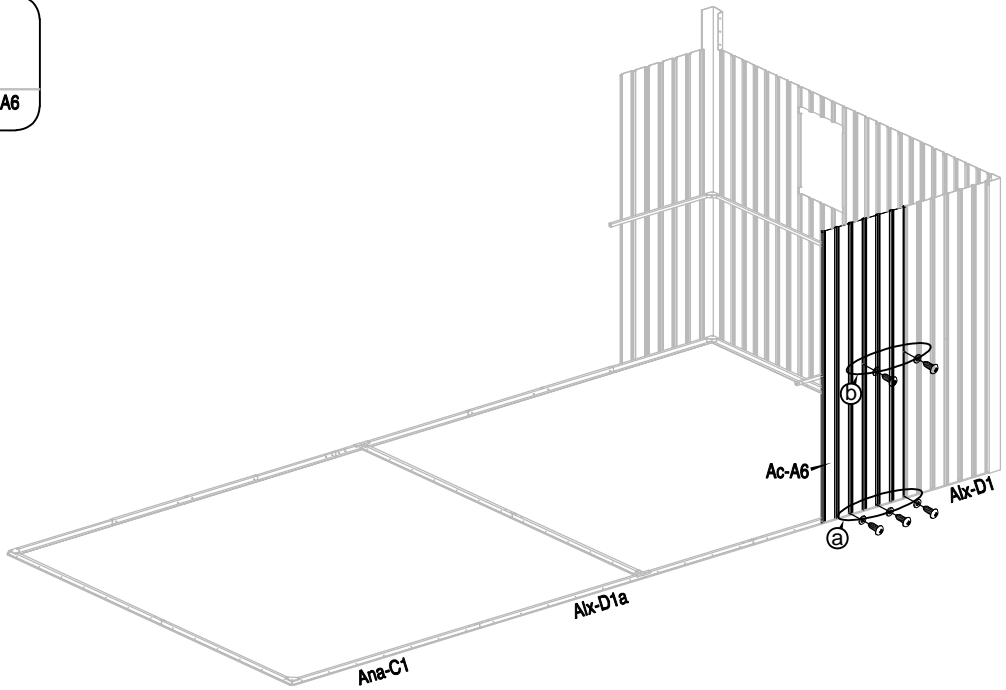
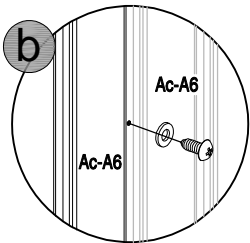
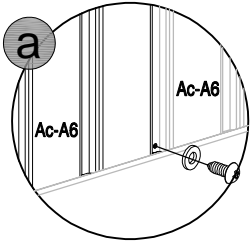
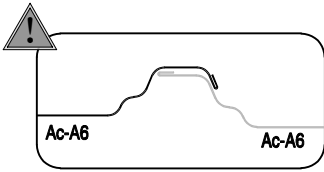

15	 Ac-A6 x1	 Alx-D41 x5	 Alx-D40 x5	
----	---	---	---	--



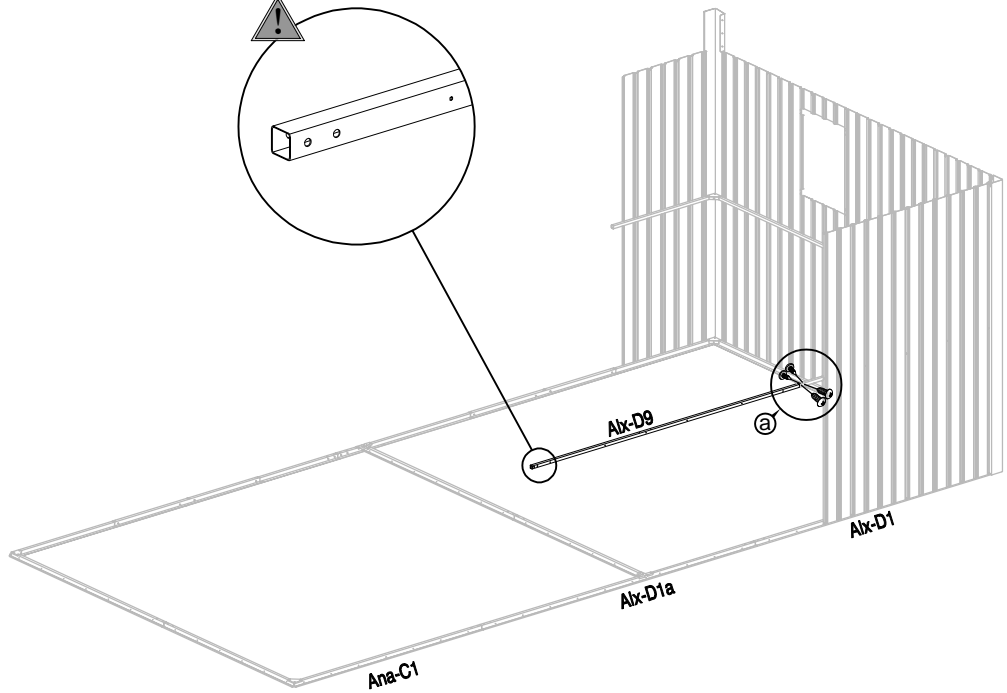
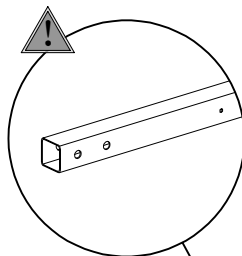
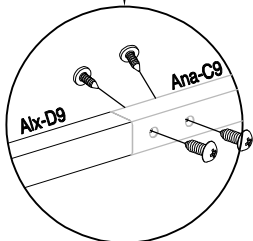
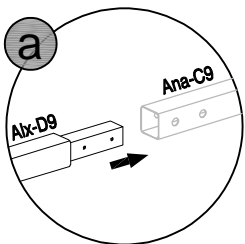

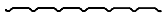
16	 Alx-D9 x1	 Alx-D41 x4	
----	--	---	--

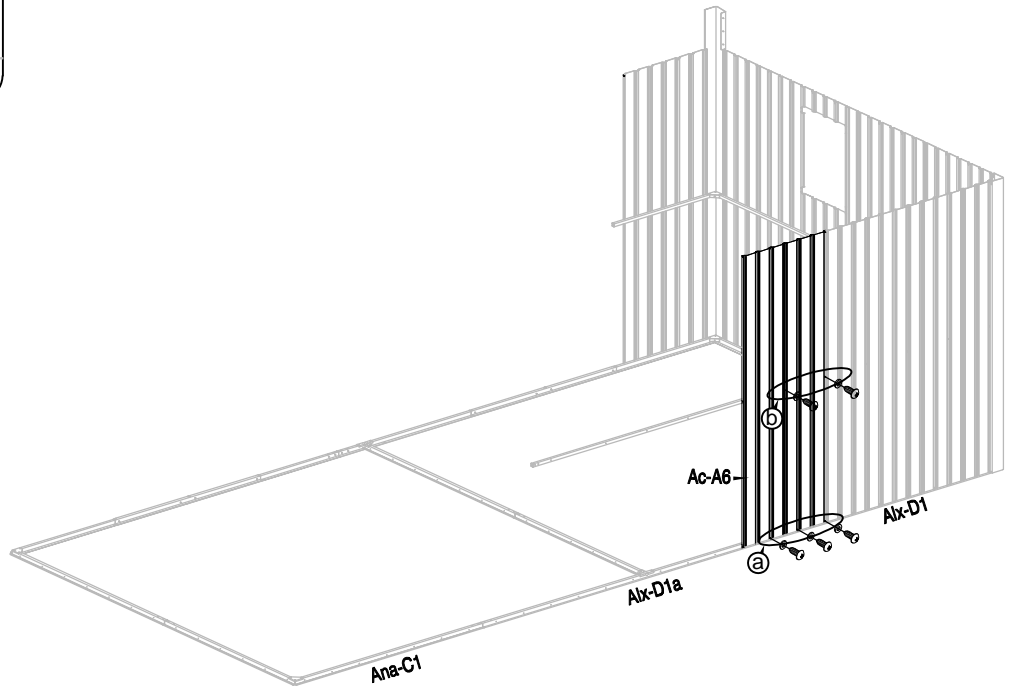
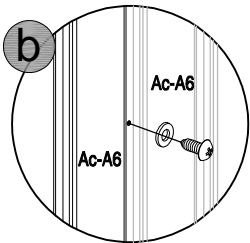
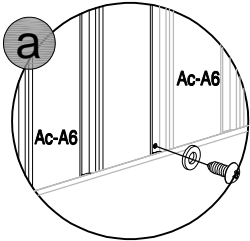
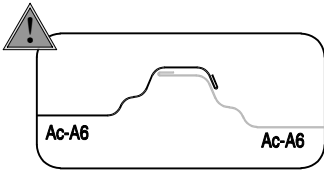

17	 Ac-A6 x1	 Alx-D41 x5	 Alx-D40 x5	
----	---	---	---	--



18	 Alx-A7 x1	 Alx-D41 x3	 Alx-D40 x3	
----	--	---	---	--

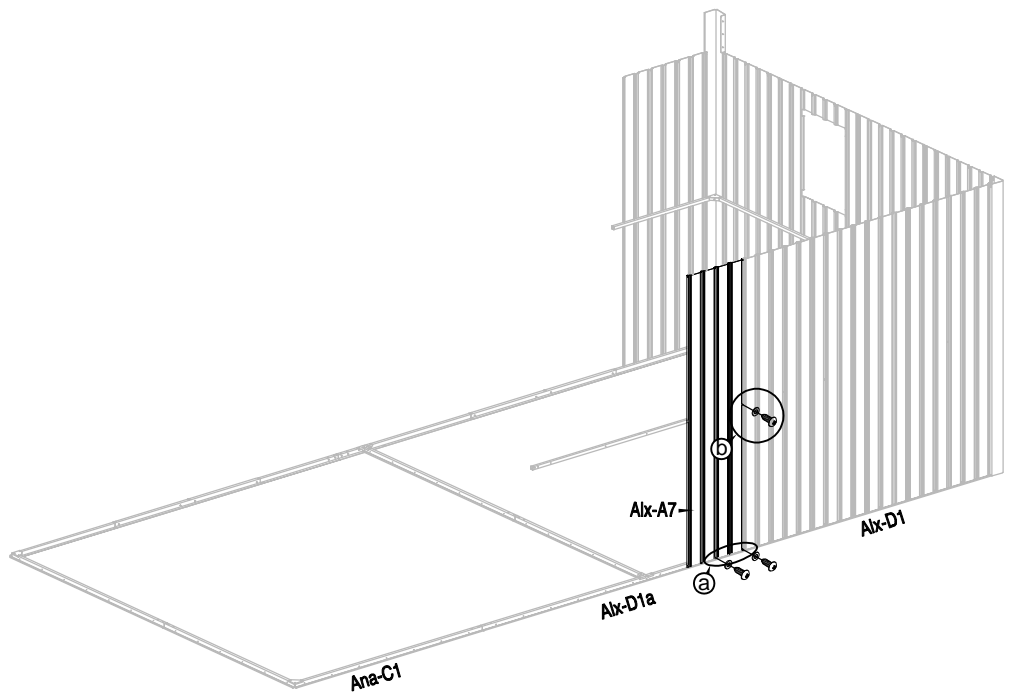
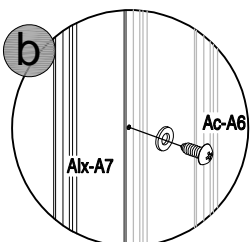
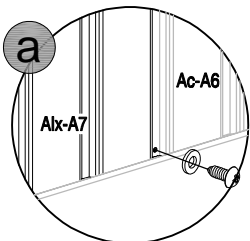
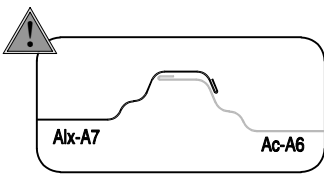

19

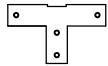

Alx-4 x1



Alx-D41 x1

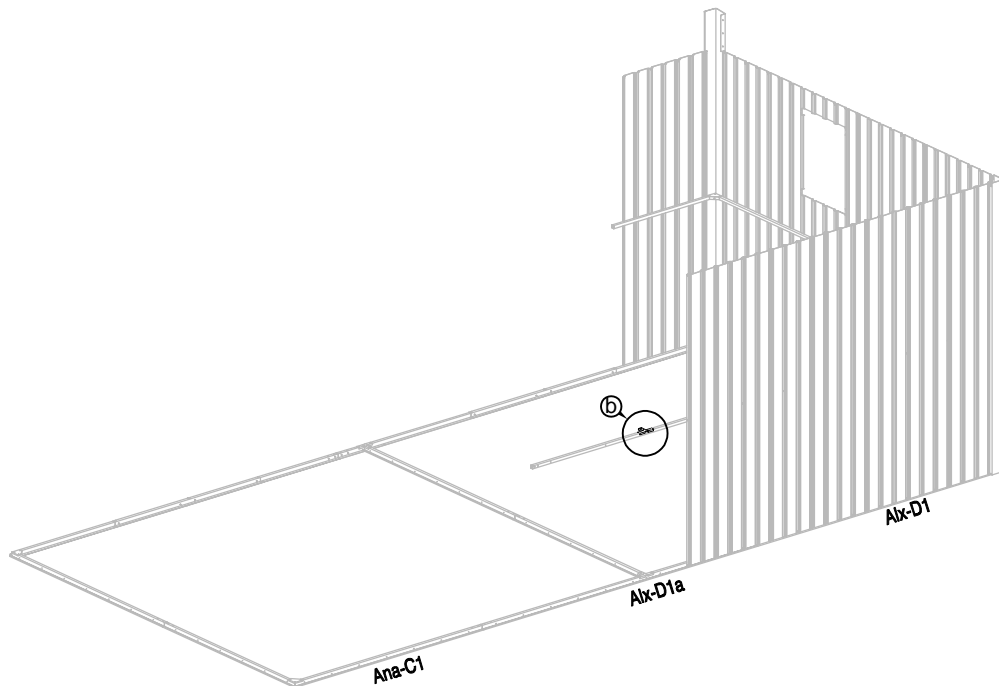
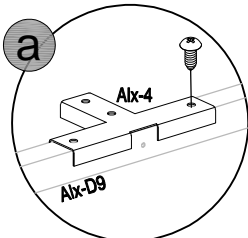

20



Alx-A5a x1



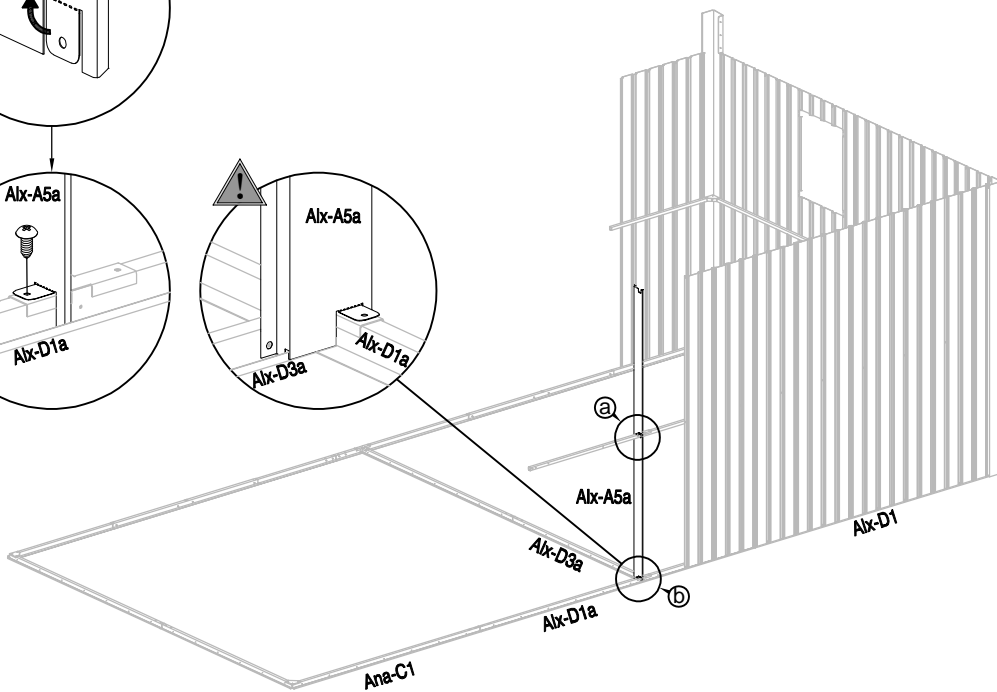
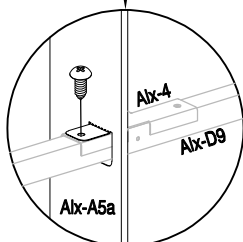
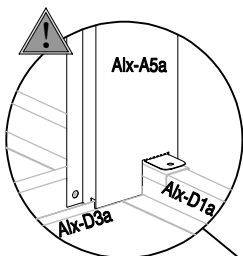
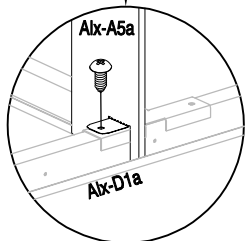
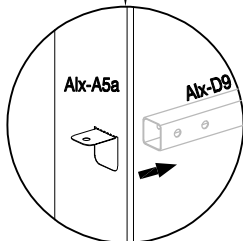
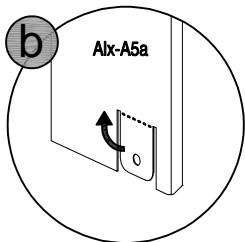
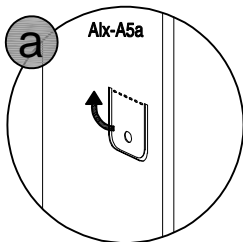

Alx-D41 x2





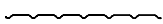

12

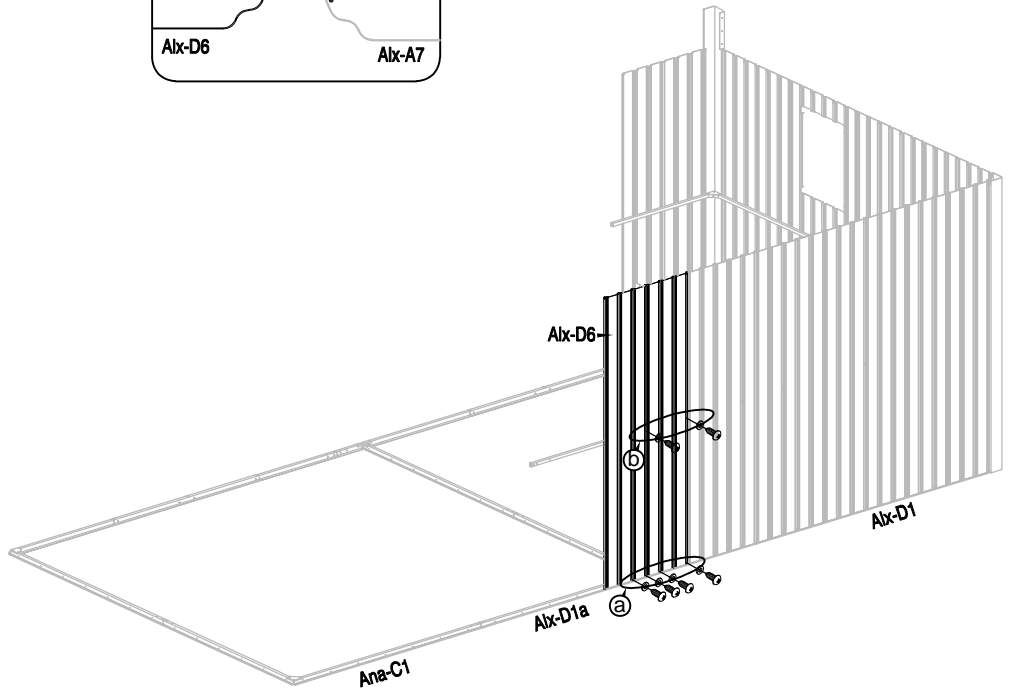
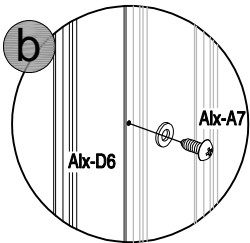
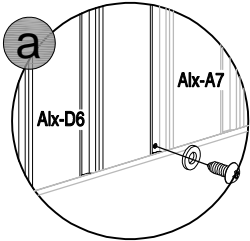
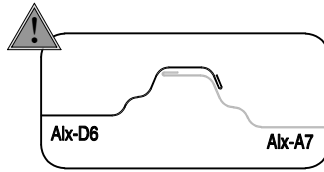
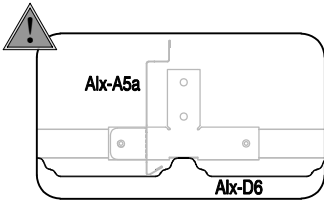

21	 Alx-D6 x1	 Alx-D41 x6	 Alx-D40 x6	
----	--	---	---	--



22	 Ac-A6 x1	 Alx-D10a x1	 Alx-D41 x5	 Alx-D40 x5	
----	---	--	---	--	--

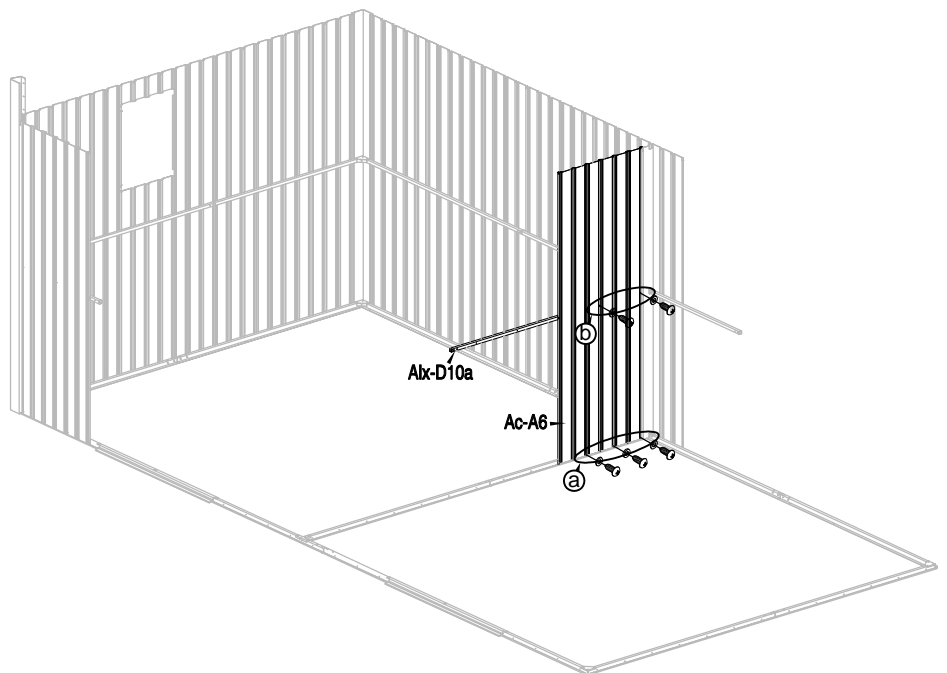
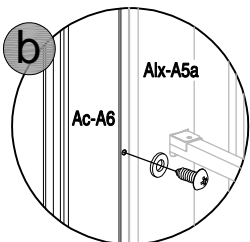
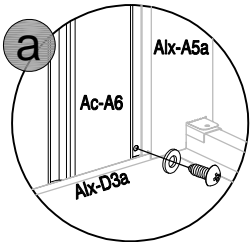
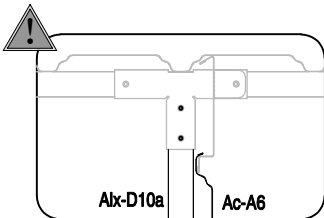

23



AIX-D41 x2

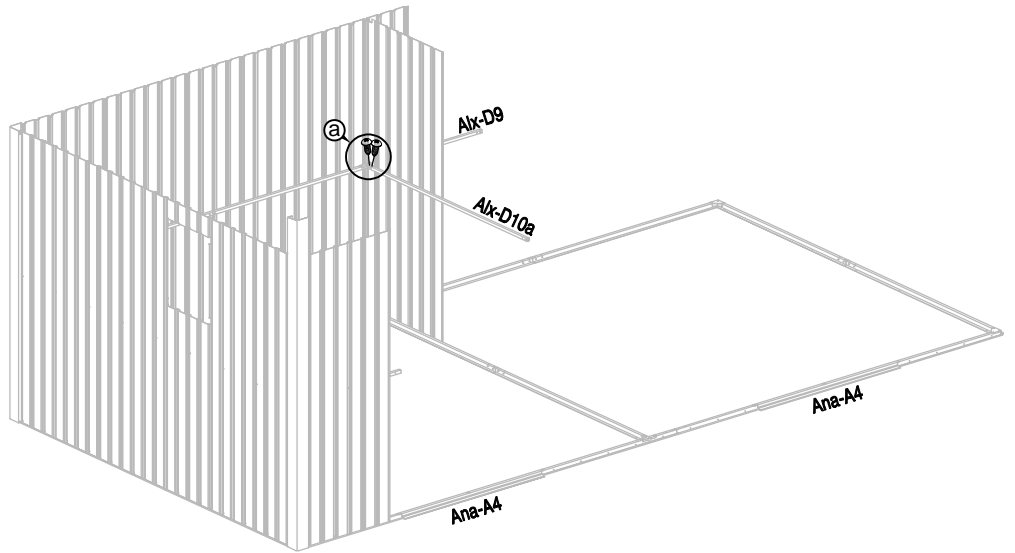
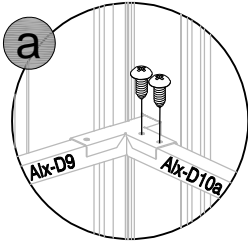

24

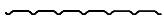

AC-A6 x1



AIX-D41 x5



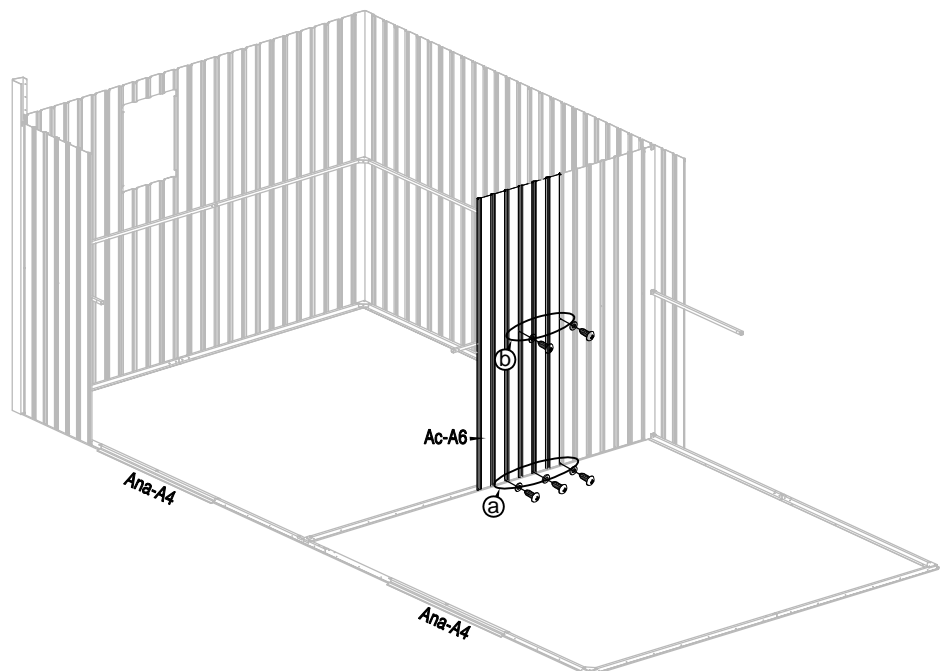
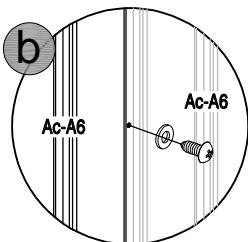
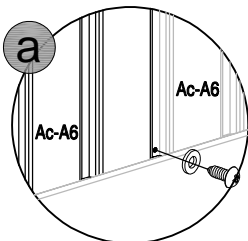
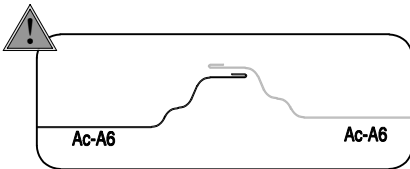

AIX-D40 x5



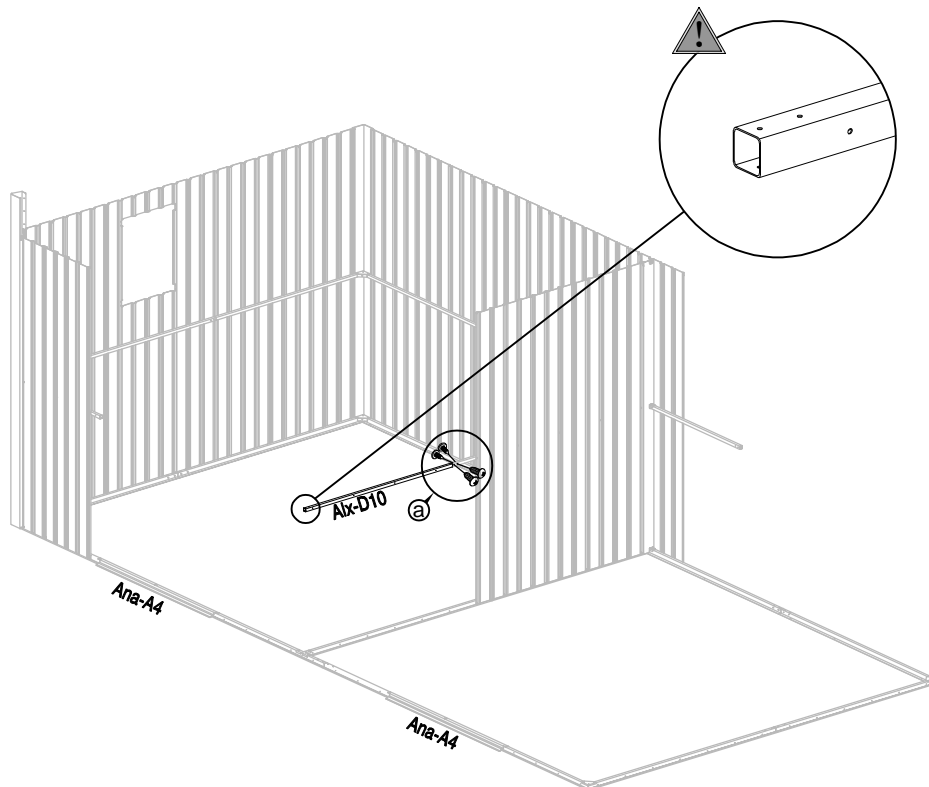
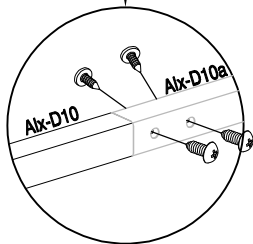
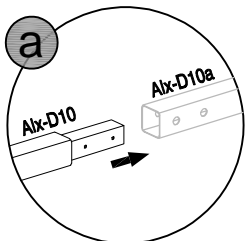

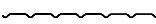
25	 Alx-D10 x1	 Alx-D41 x4	
----	---	---	--



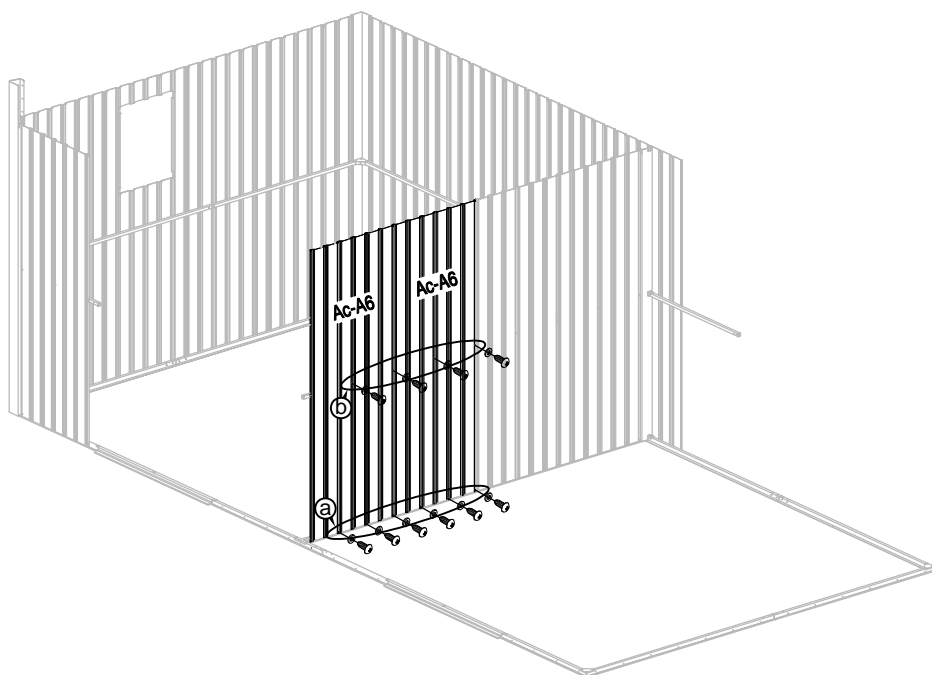
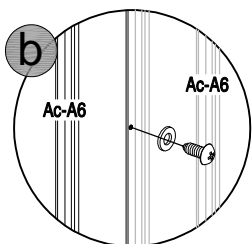
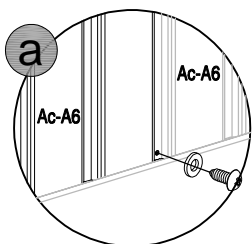
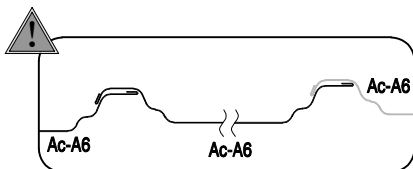

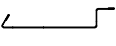
26	 Ac-A6 x2	 Alx-D41 x10	 Alx-D40 x10	
----	---	--	--	--



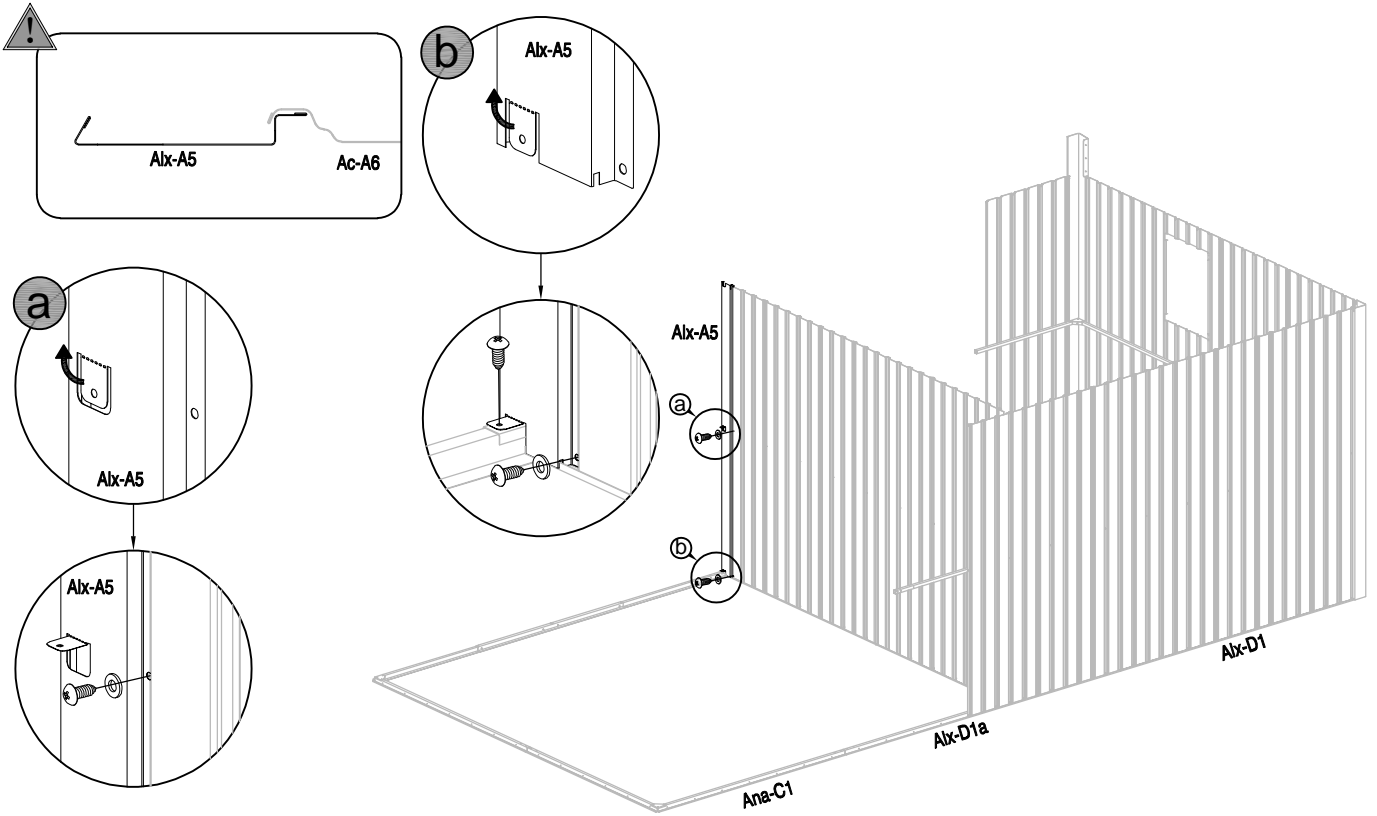

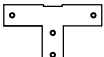
27	 Alx-A5 x1	 Alx-D41 x3	 Alx-D40 x2	
----	--	---	---	--



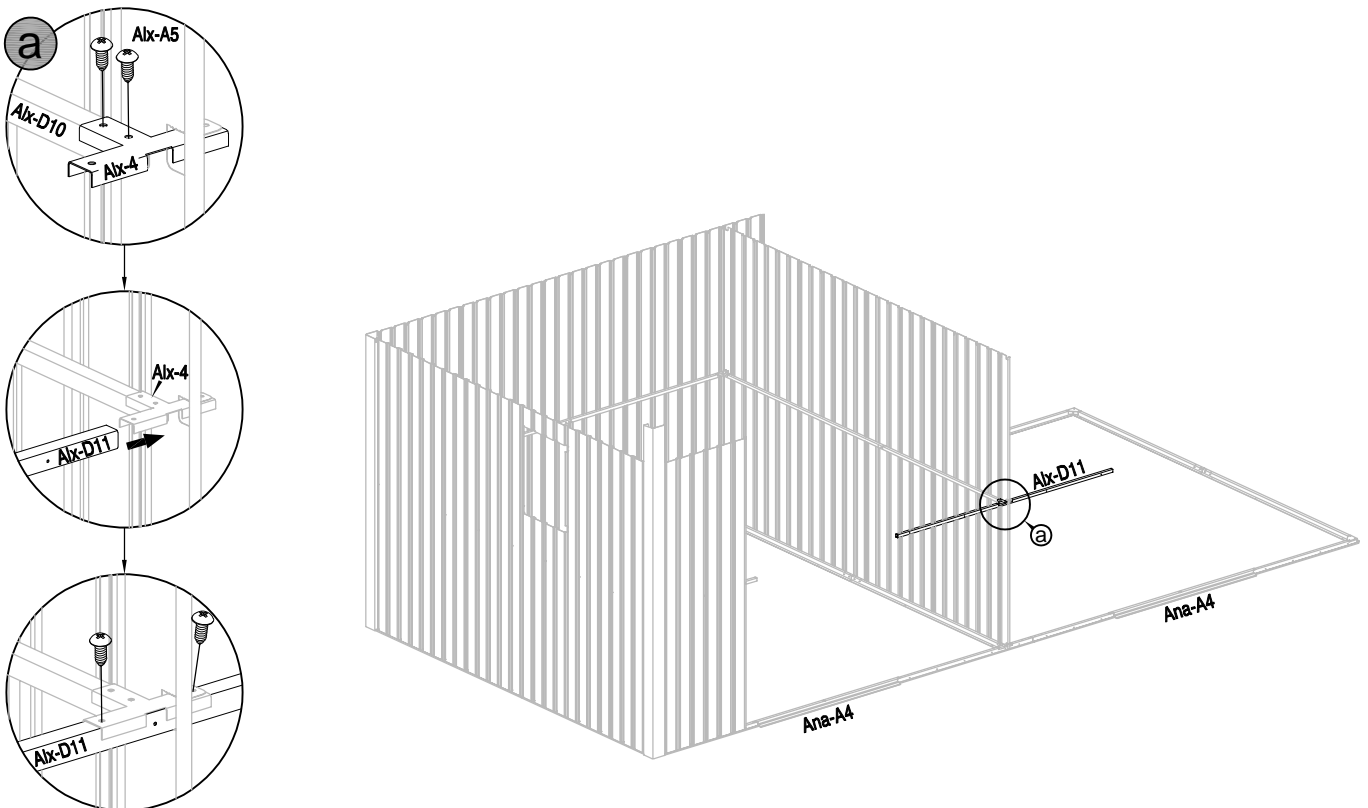

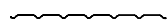
28	 Alx-4 x1	 Alx-D11 x1	 Alx-D41 x4	
----	---	---	---	--



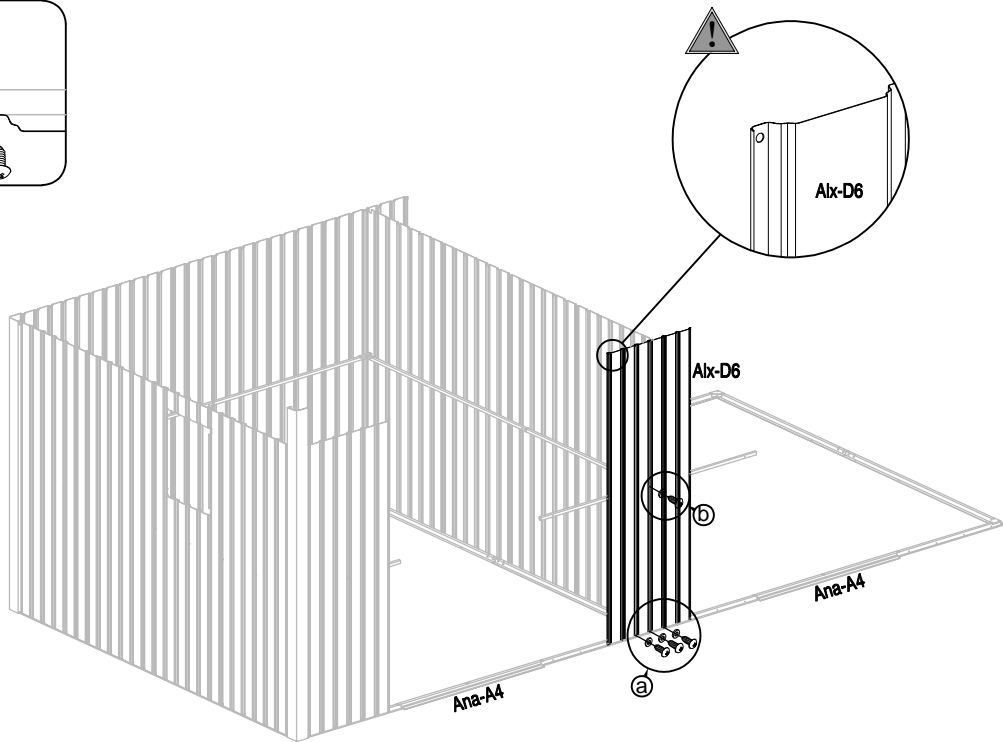
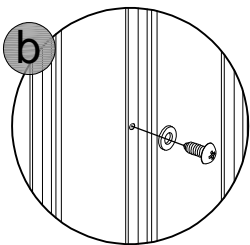
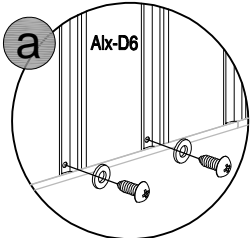
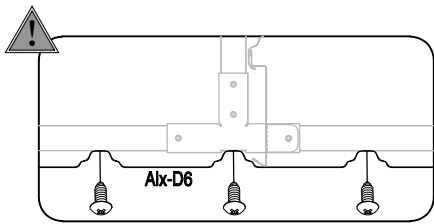

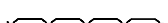
29	 Alx-D6 x1	 Alx-D41 x4	 Alx-D40 x4	
----	--	---	---	--

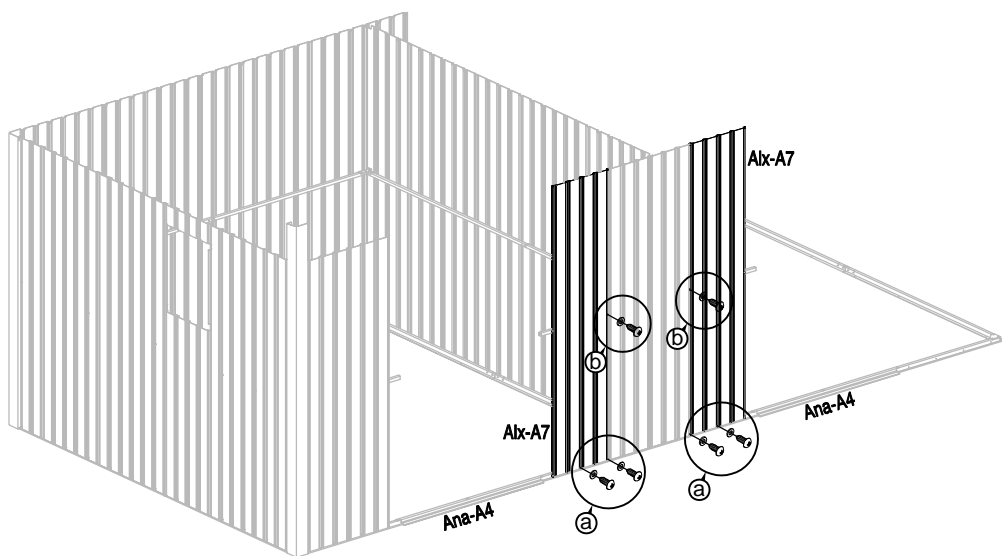
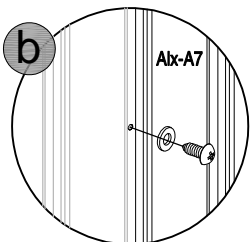
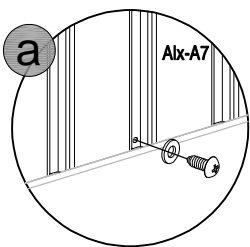
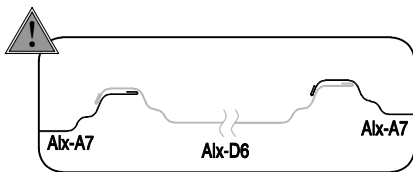

30	 Alx-A7 x2	 Alx-D41 x6	 Alx-D40 x6	
----	--	---	---	--



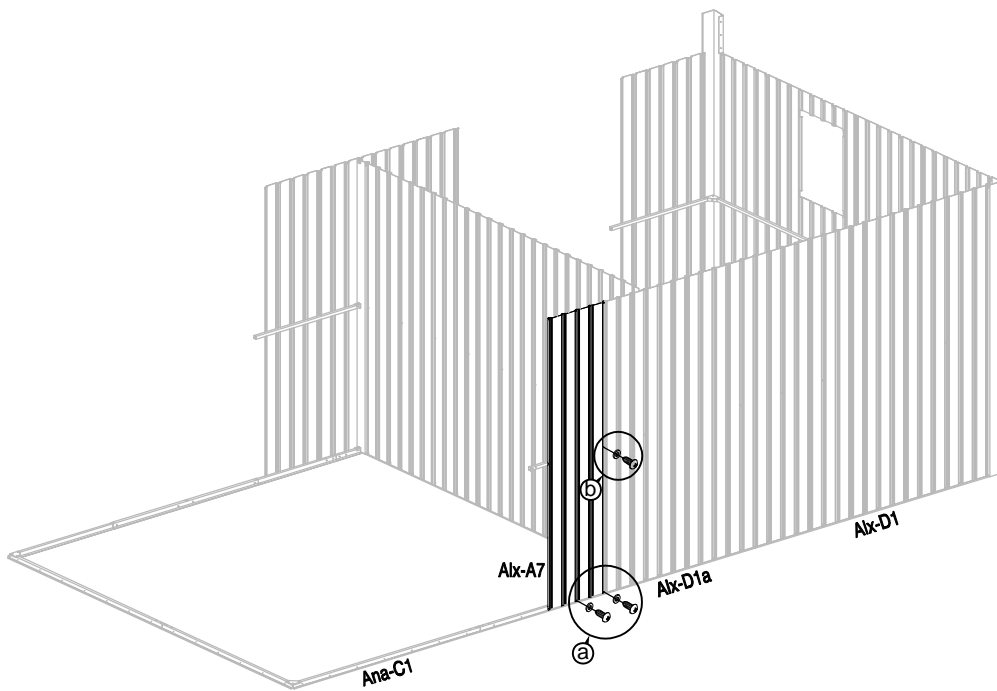
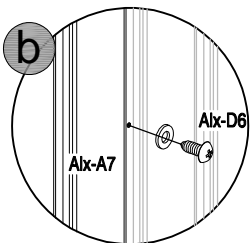
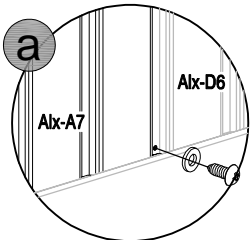
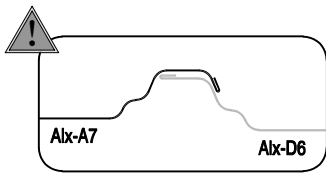

31	 Alx-A7 x1	 Alx-D41 x3	 Alx-D40 x3	
----	--	---	---	--



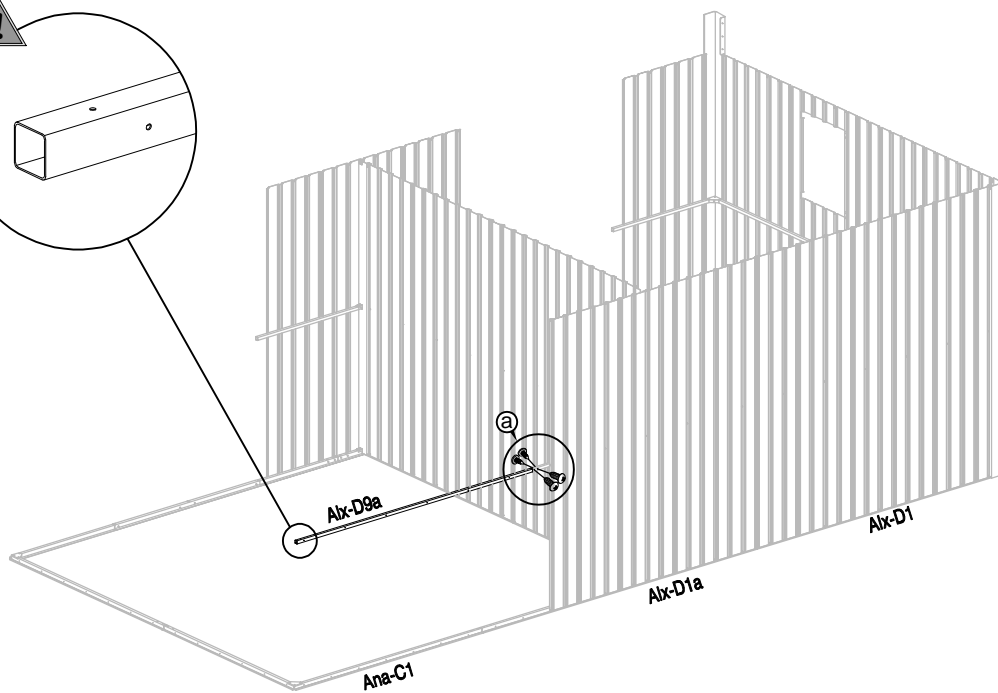
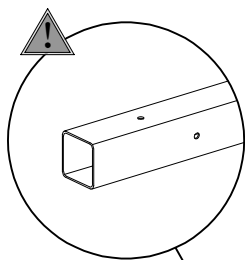
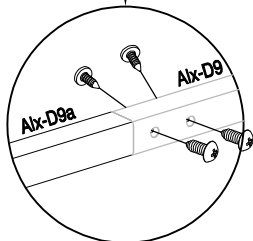
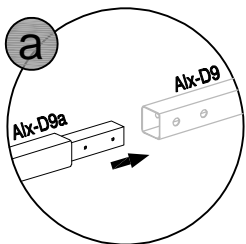

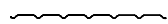
32	 Alx-D9a x1	 Alx-D41 x4	
----	---	---	--



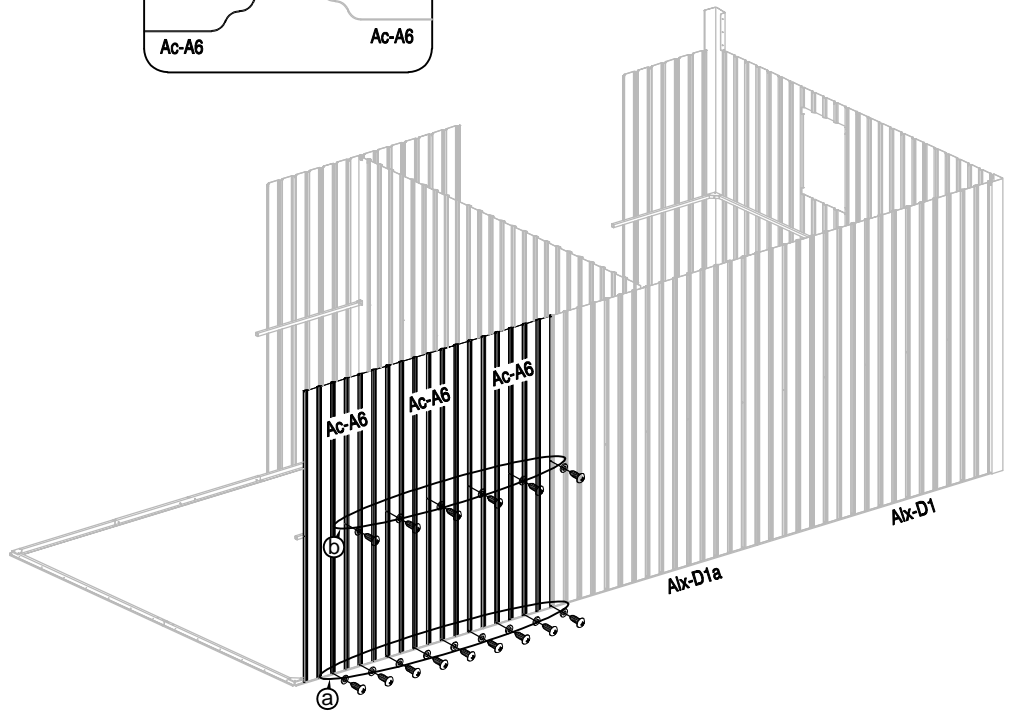
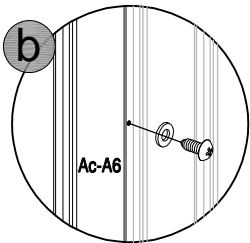
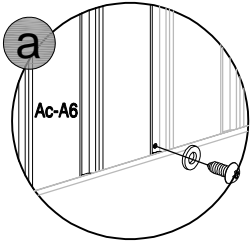
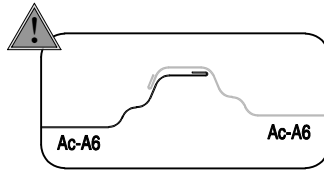
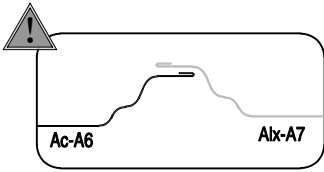



33	 Ac-A6 x3	 Alx-D41 x15	 Alx-D40 x15	
----	---	--	--	--

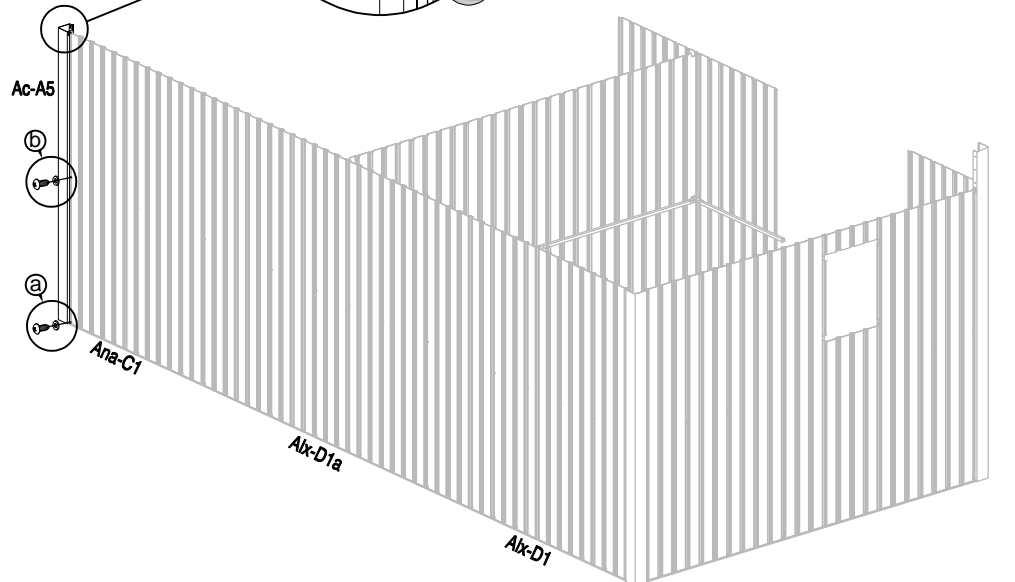
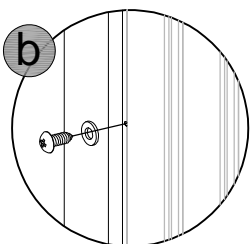
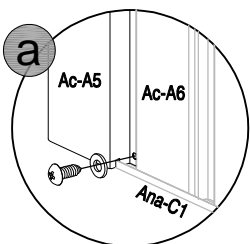
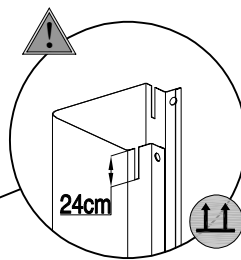
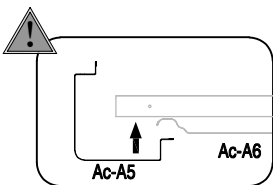

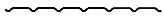
34	 Ac-A5 x1	 Alx-D41 x2	 Alx-D40 x2	
----	---	---	---	--



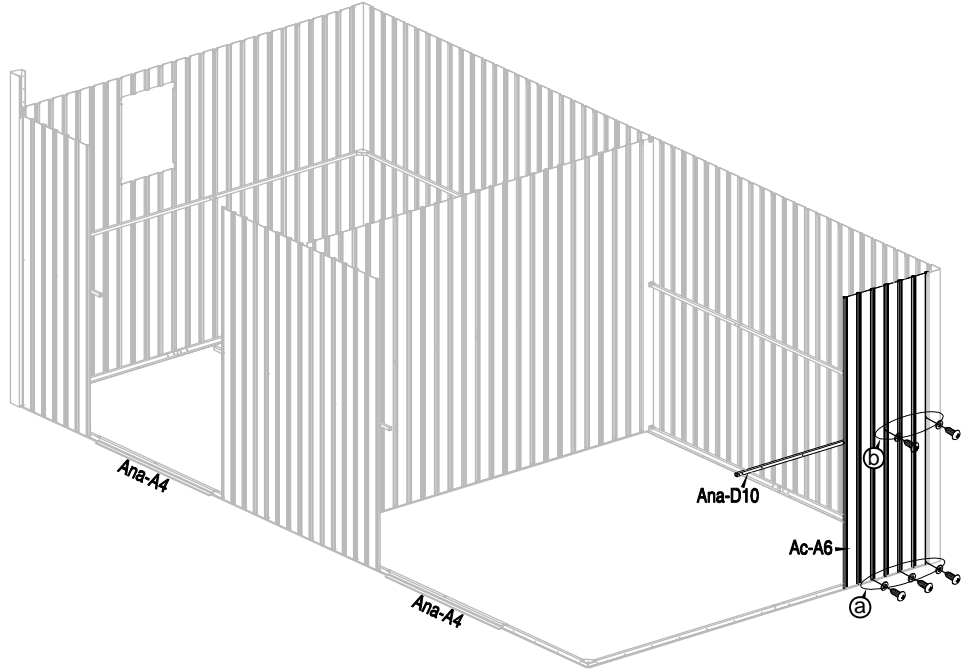
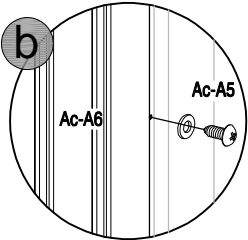
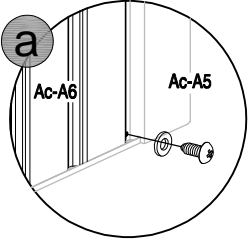
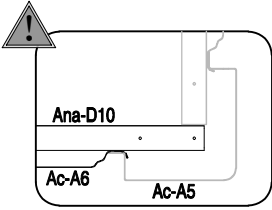

35	 Ac-A6 x1	 Ana-D10 x1	 Alx-D41 x5	 Alx-D40 x5	
----	---	---	---	--	--

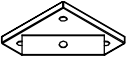

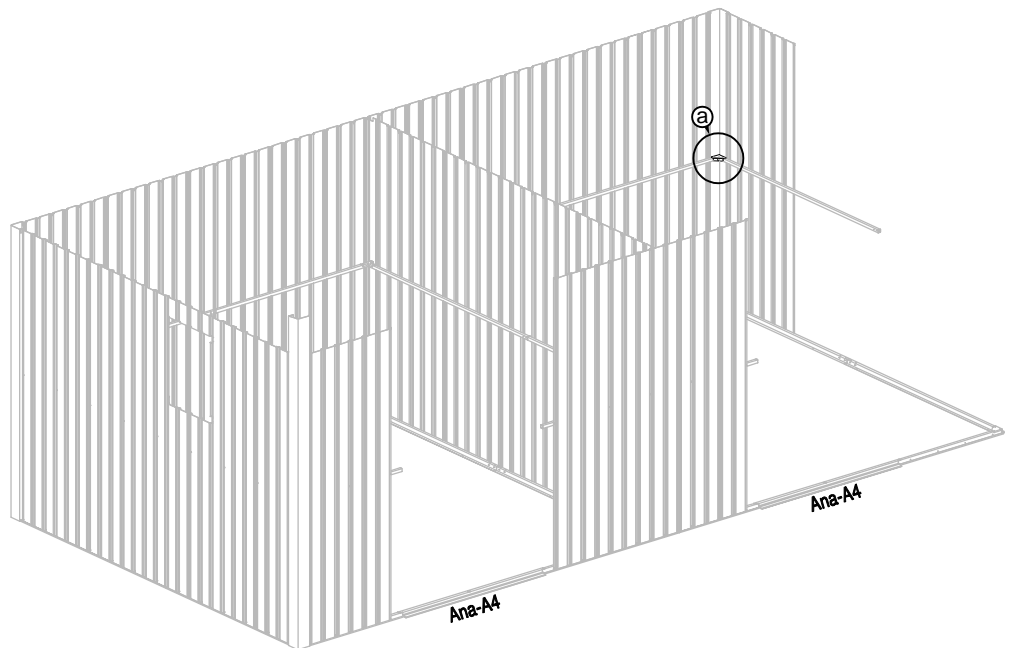
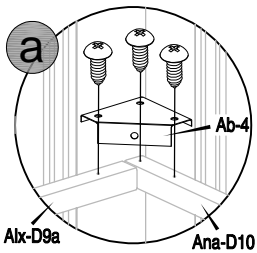
36	 Ab-4 x1	 Alx-D41 x3	
----	--	---	--

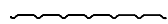

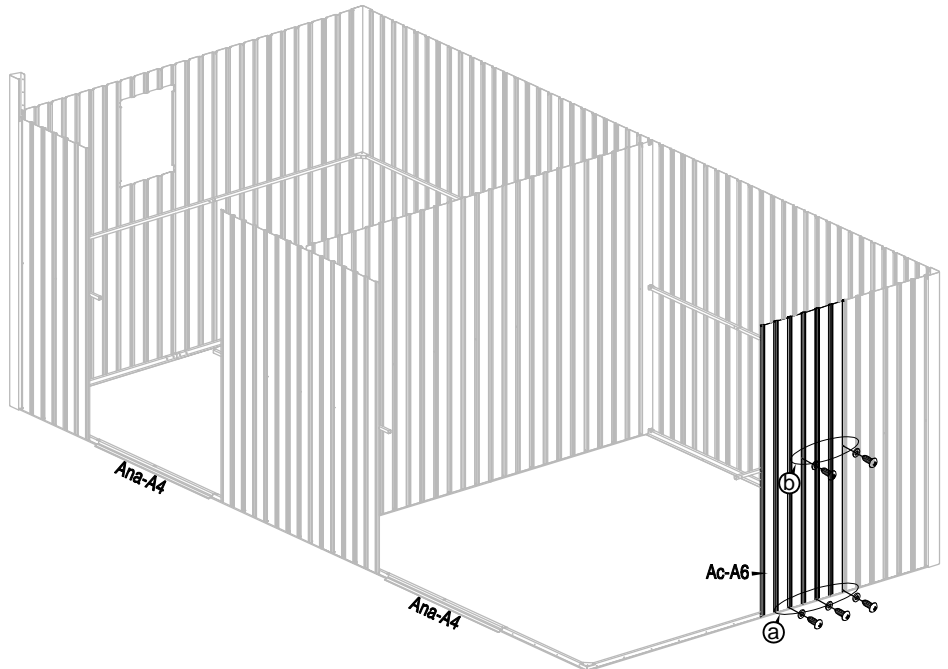
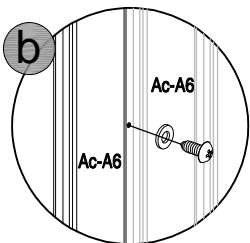
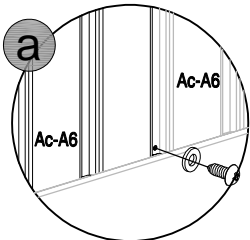
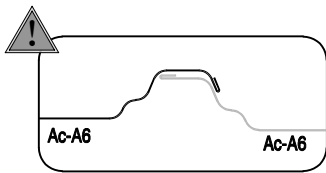

37	 Ac-A6 x1	 Alx-D41 x5	 Alx-D40 x5	
----	---	---	---	--



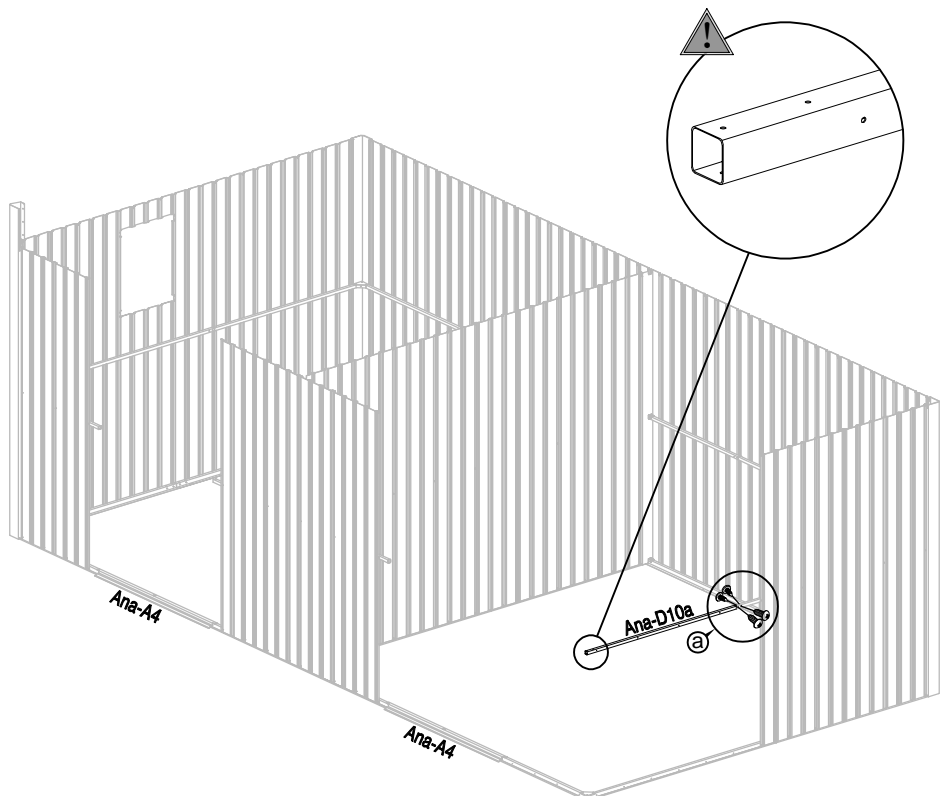
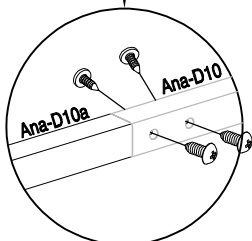
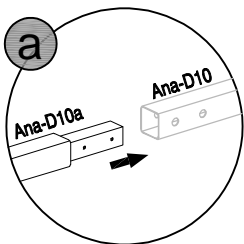

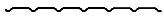
38	 Ana-D10a x1	 Alx-D41 x4	
----	--	---	--



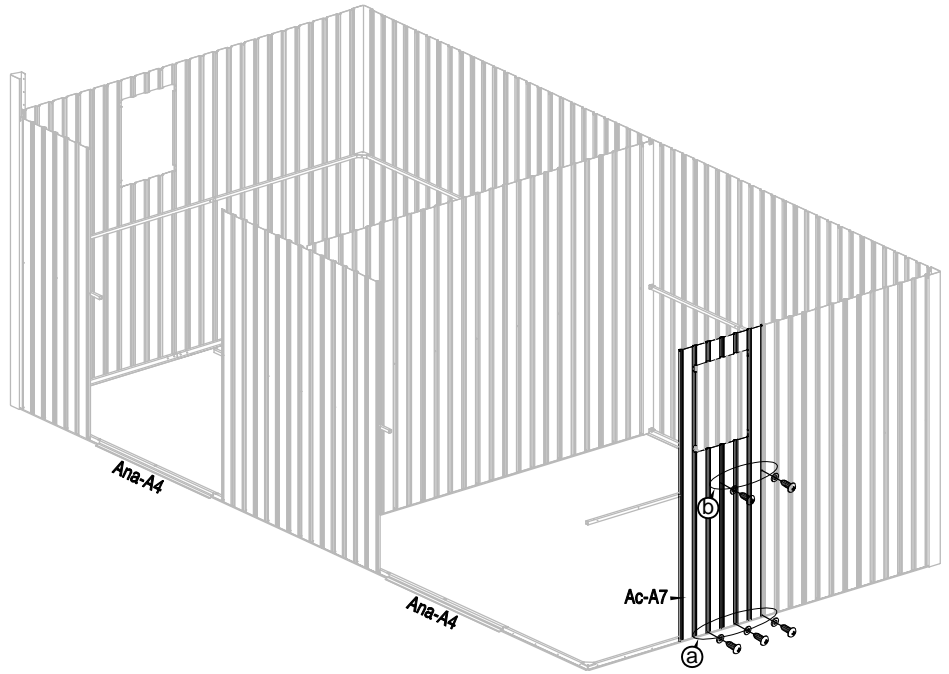
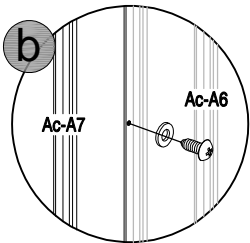
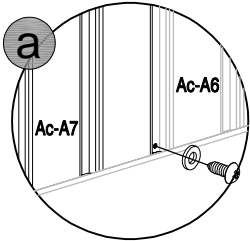
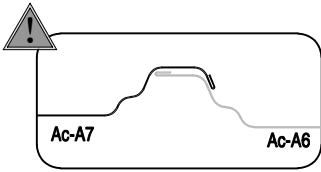

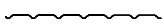
39	 Ac-A7 x1	 A1x-D41 x5	 A1x-D40 x5	
----	---	---	---	--



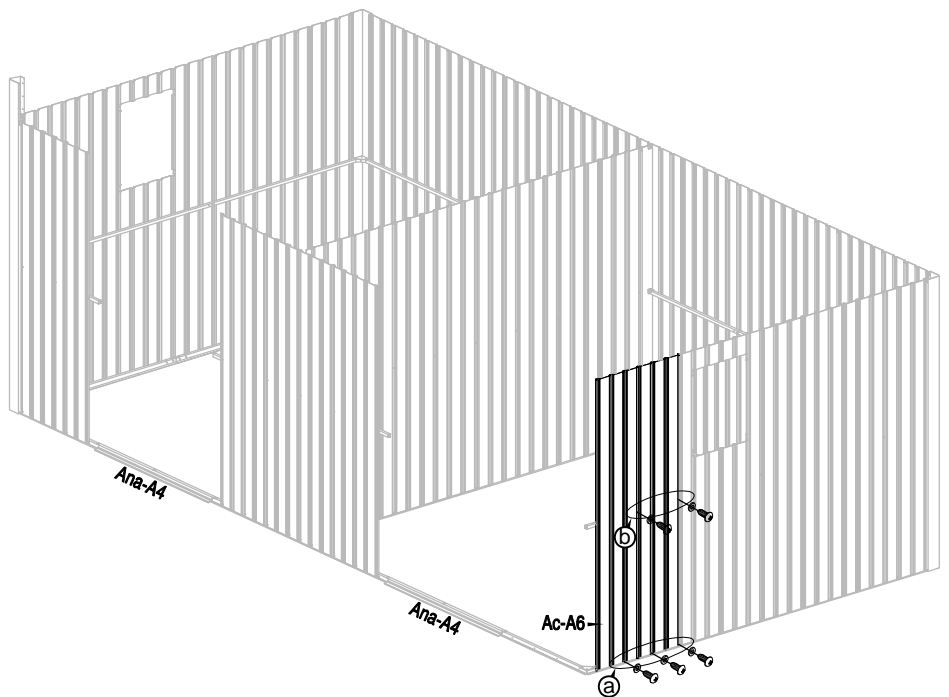
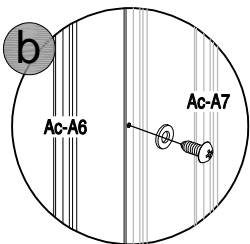
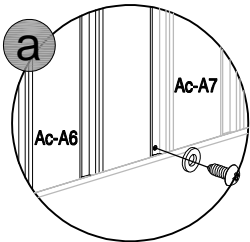
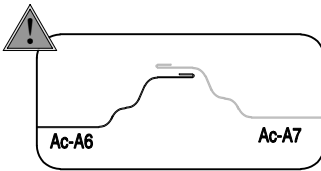



40	 Ac-A6 x1	 A1x-D41 x5	 A1x-D40 x5	
----	---	---	---	--

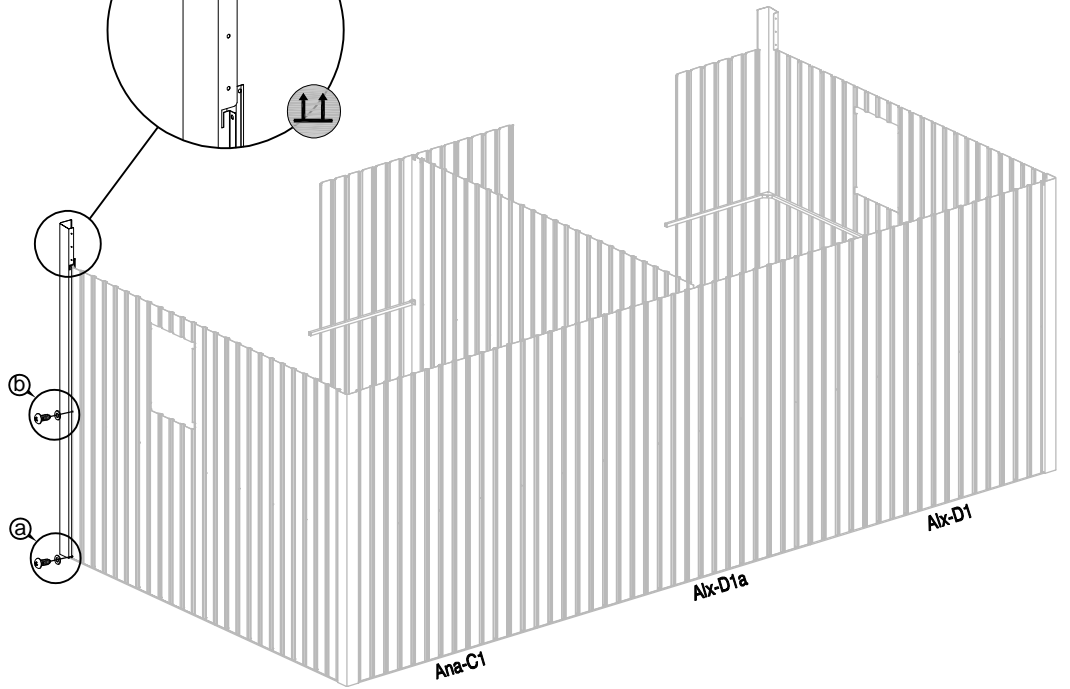
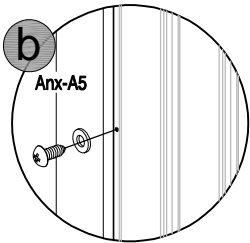
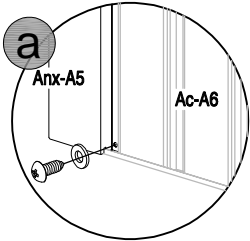
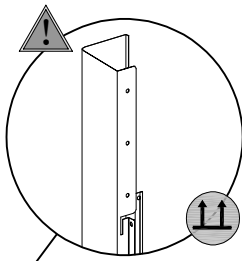
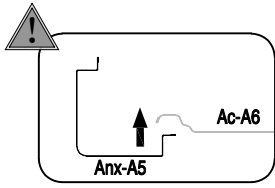

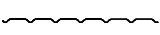
41	 Anx-A5 x1	 Alx-D41 x2	 Alx-D40 x2	
----	--	---	---	--



42	 Ac-A6 x1	 Ana-C1 x1	 Alx-D41 x5	 Alx-D40 x5	
----	---	--	---	--	--

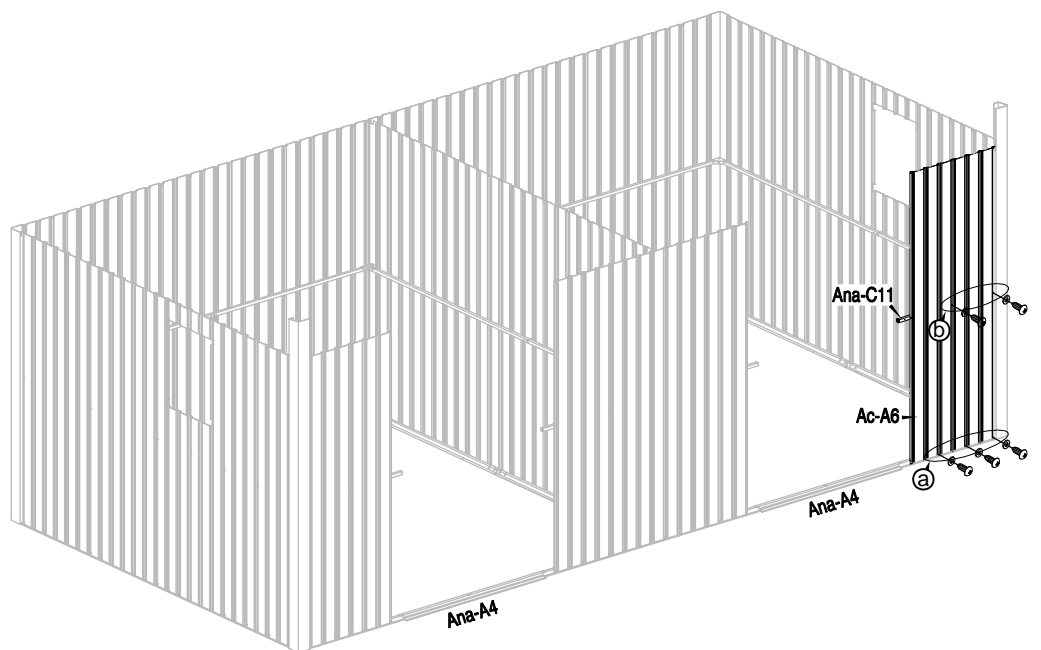
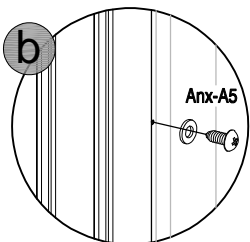
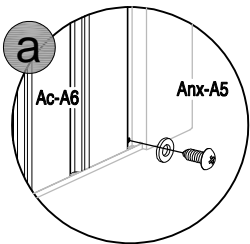
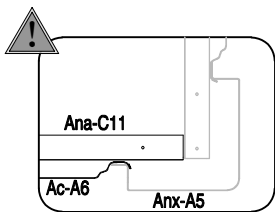

43

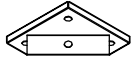

Ab-4 x1



Alx-D41 x3

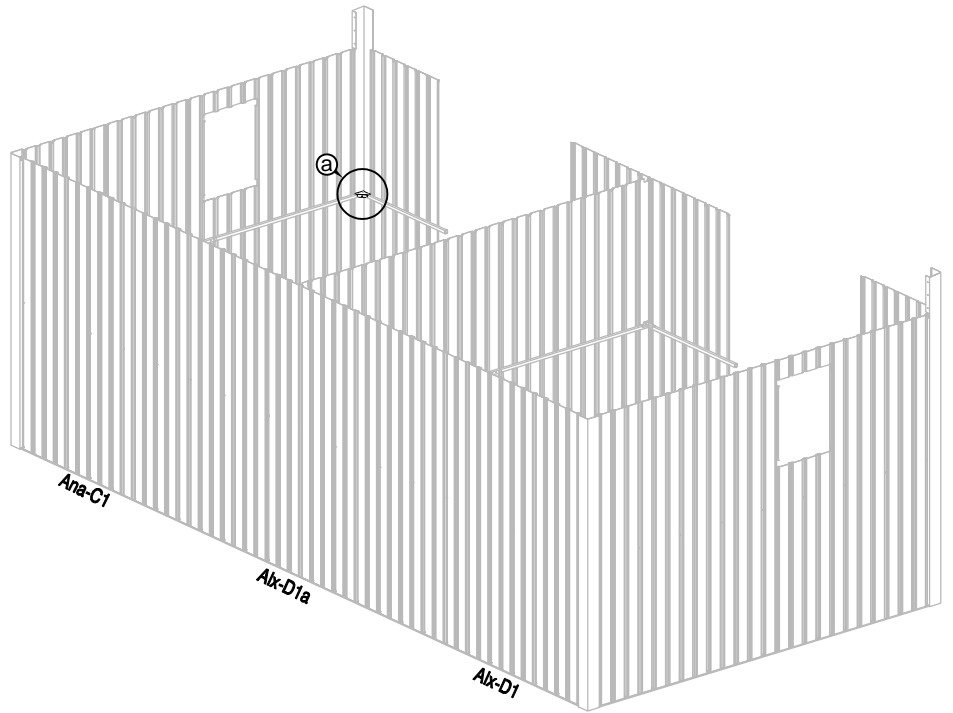
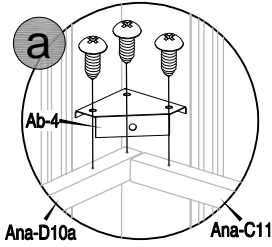

44

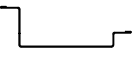

Ana-A16 x2

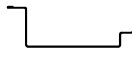

Ana-A16a x2







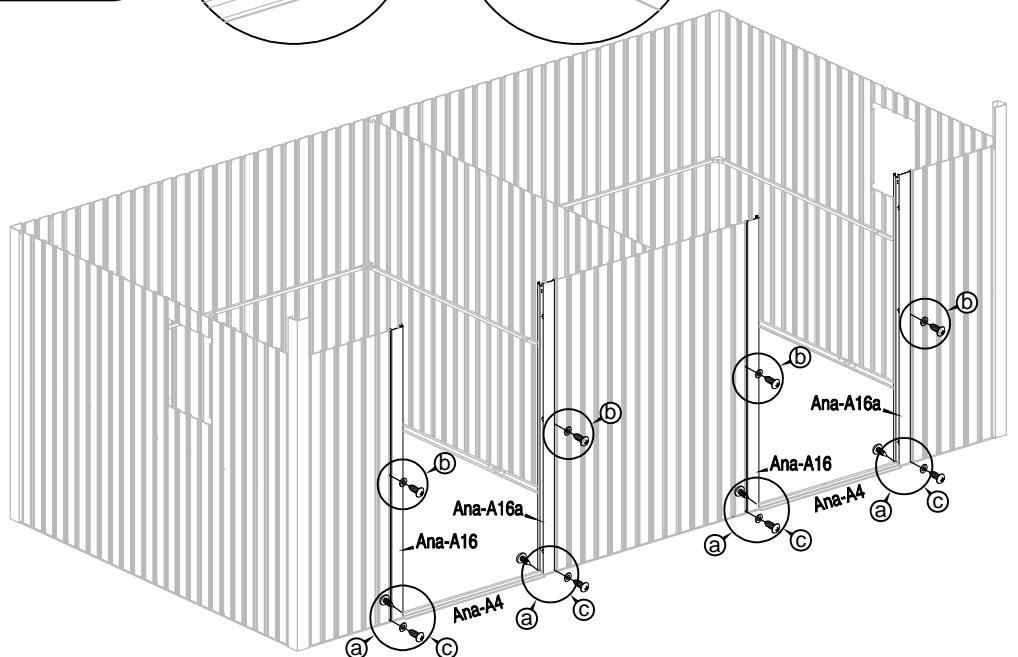
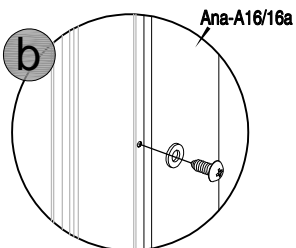
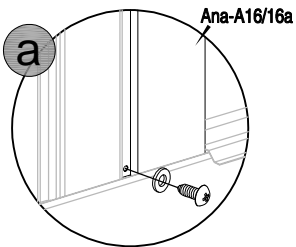
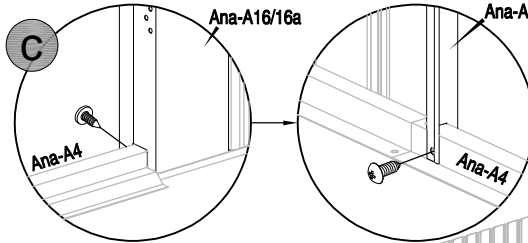
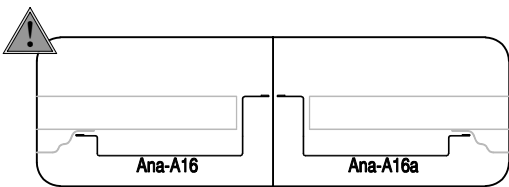

Alx-D41 x12



Alx-D40 x8



45	 Alc-C12 x1	 Ana-C13 x1	 Alx-D12 x1	 Alx-D12a x1	 Alx-D13 x1	 Alx-D13a x1	 Alx-D41 x16	
----	---	---	---	--	---	--	--	--

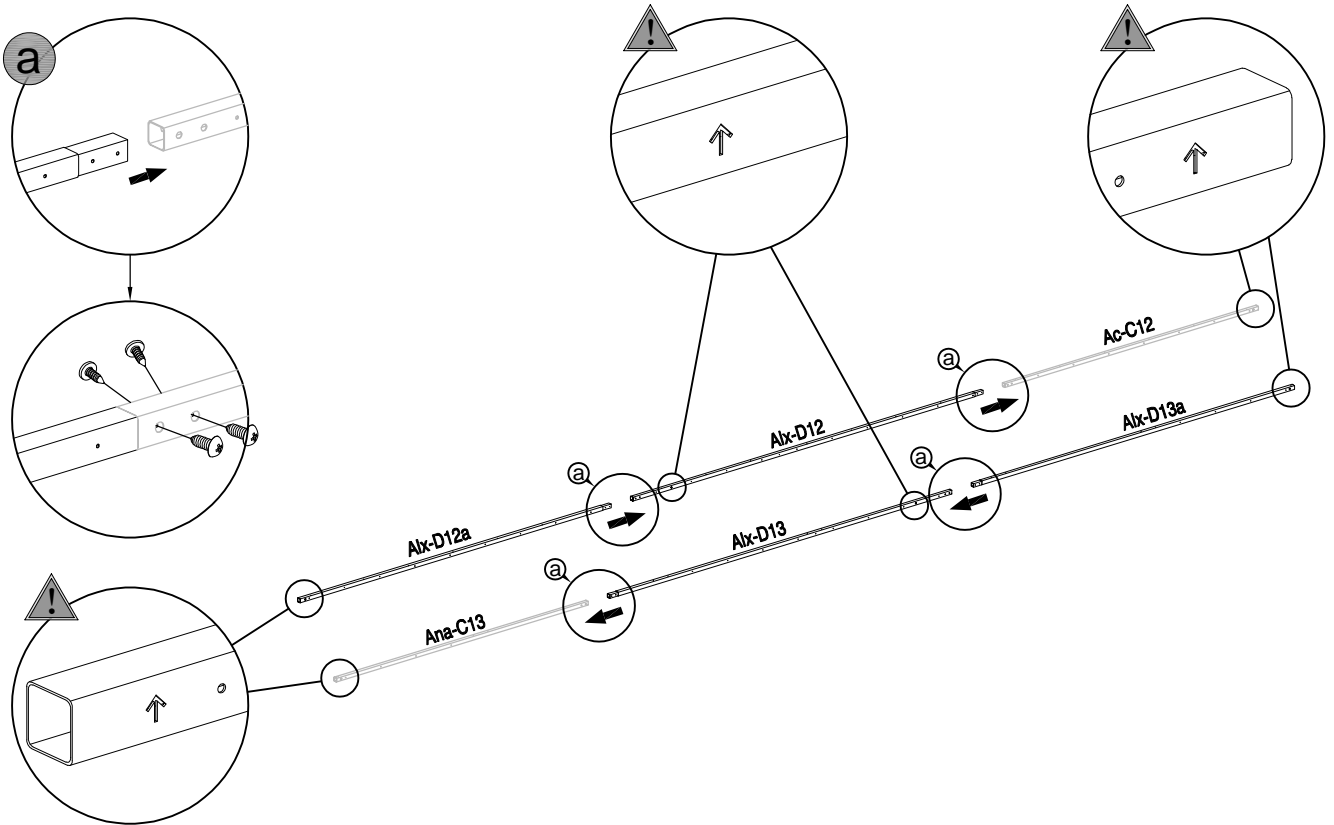

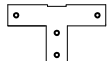
46	 Alx-4 x2	 Alx-D41 x4	
----	---	---	--

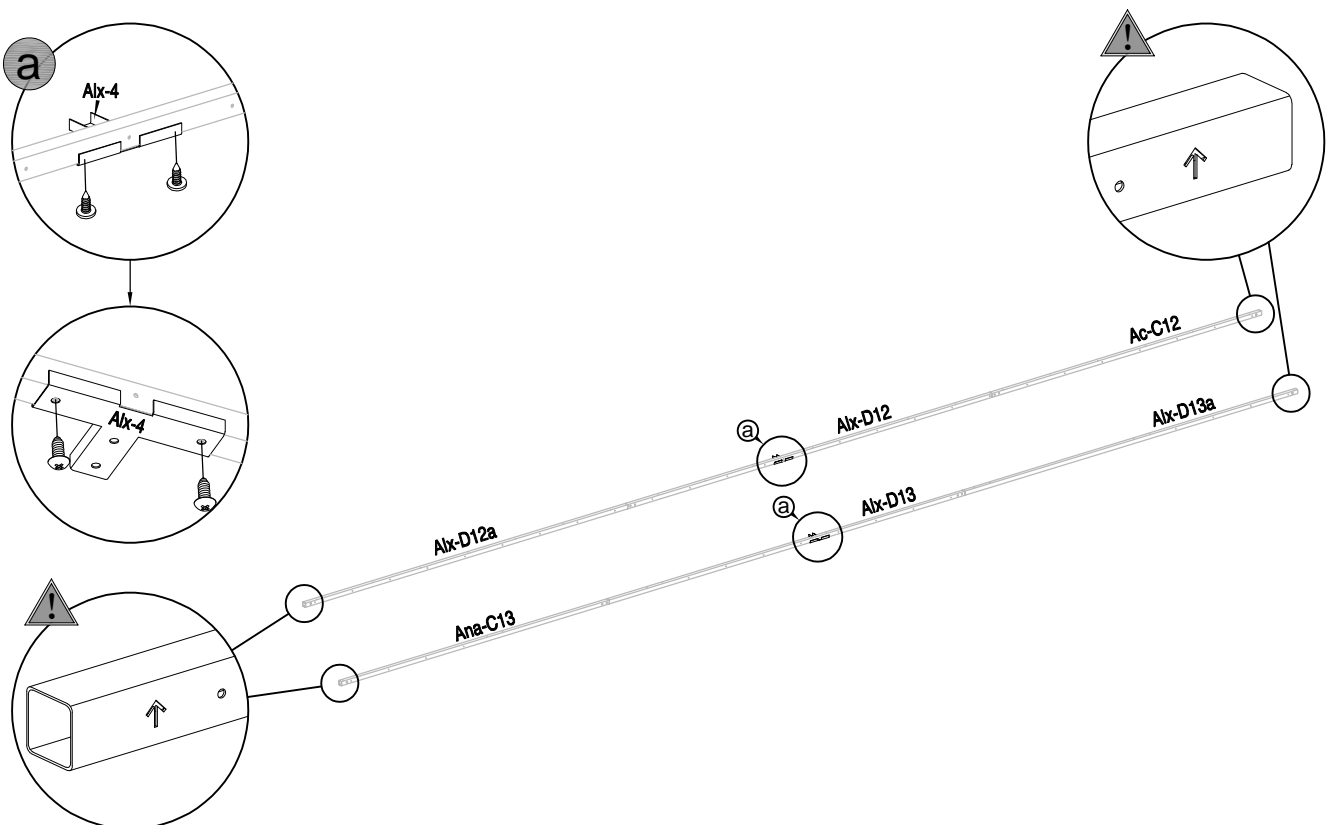

47

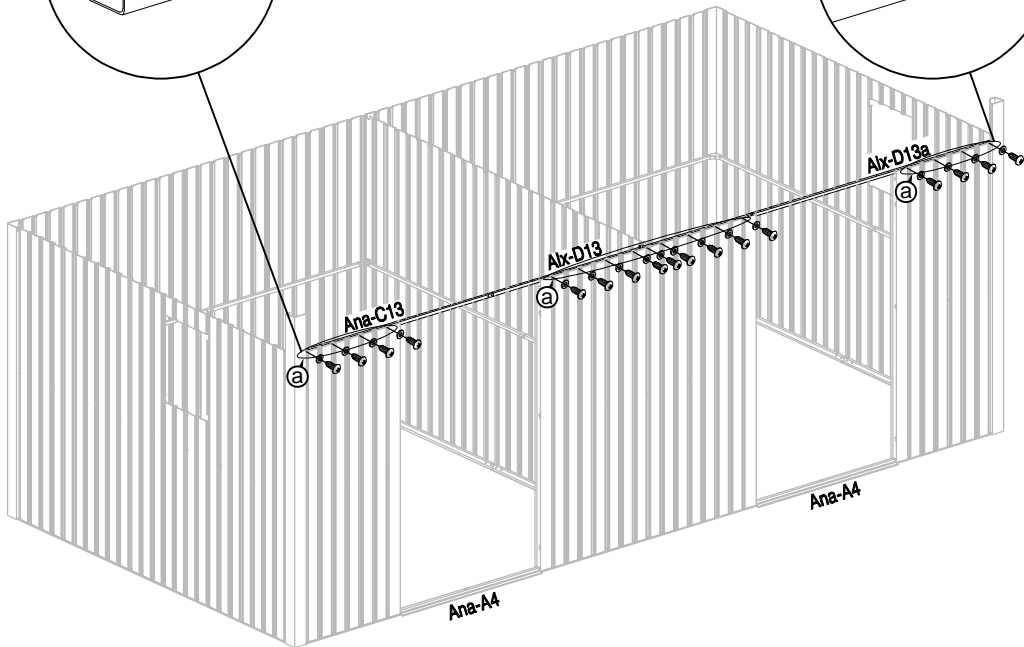
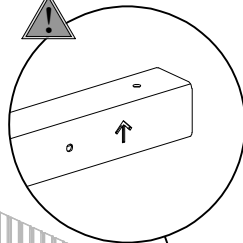
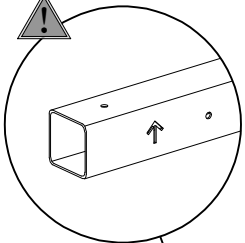
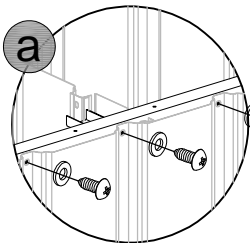



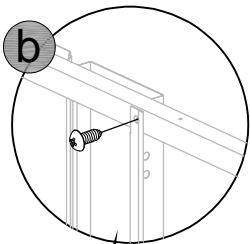
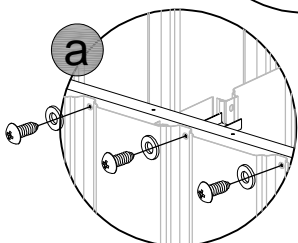
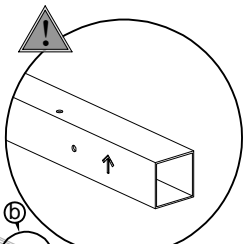
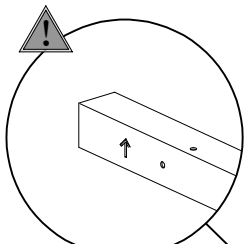

48

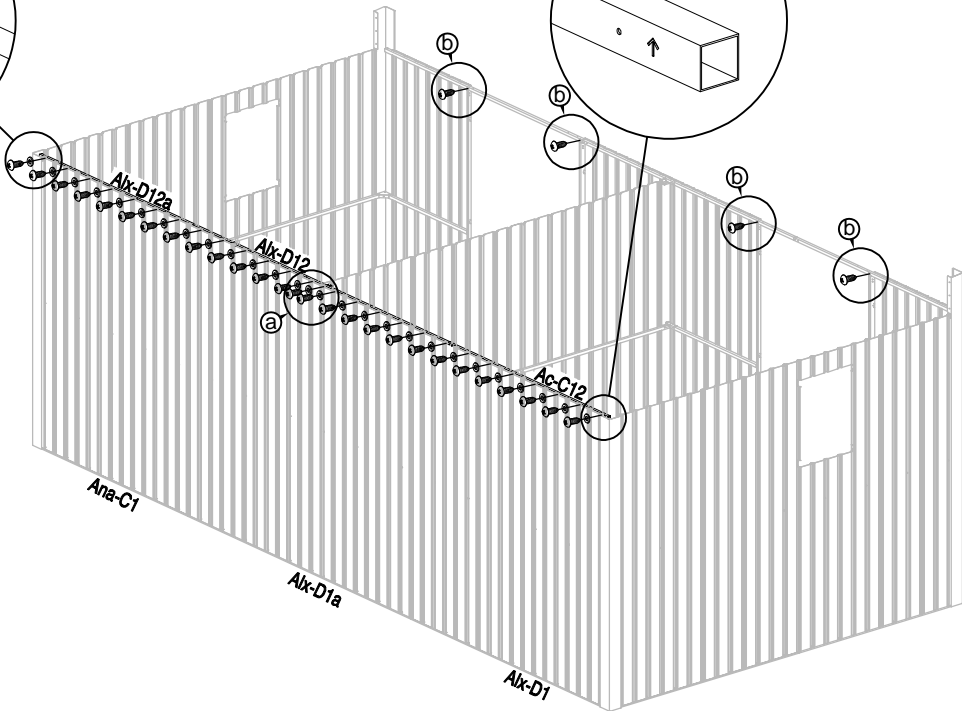

Ana-A16/16a



49	 Anx-D14 x2	 Anx-D14a x2	 Alx-D14 x1	 Alx-D14a x1	 Alx-D41 x12	
----	---	--	---	---	--	--

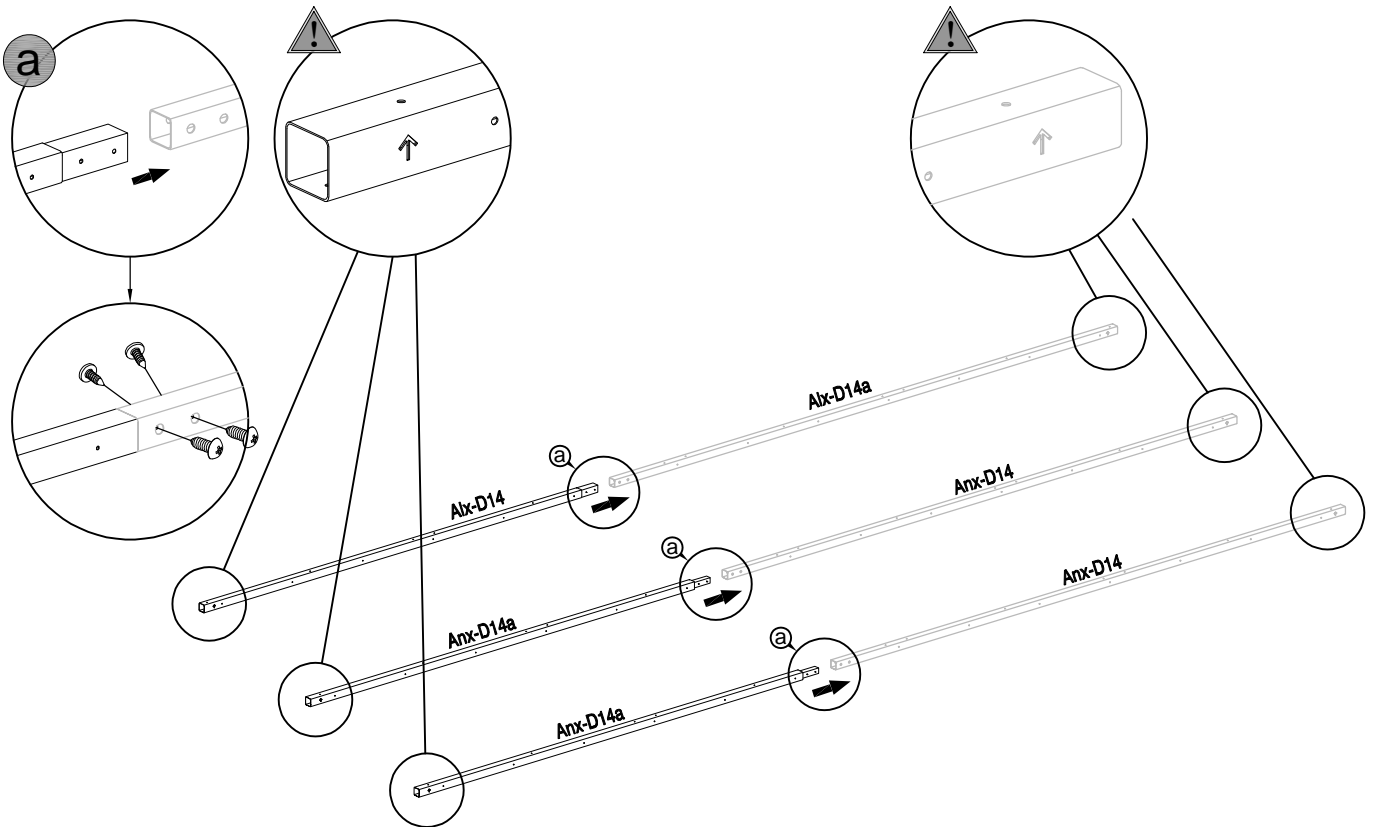

50	 Alx-D41 x13	 Alx-D40 x13	
----	--	--	--

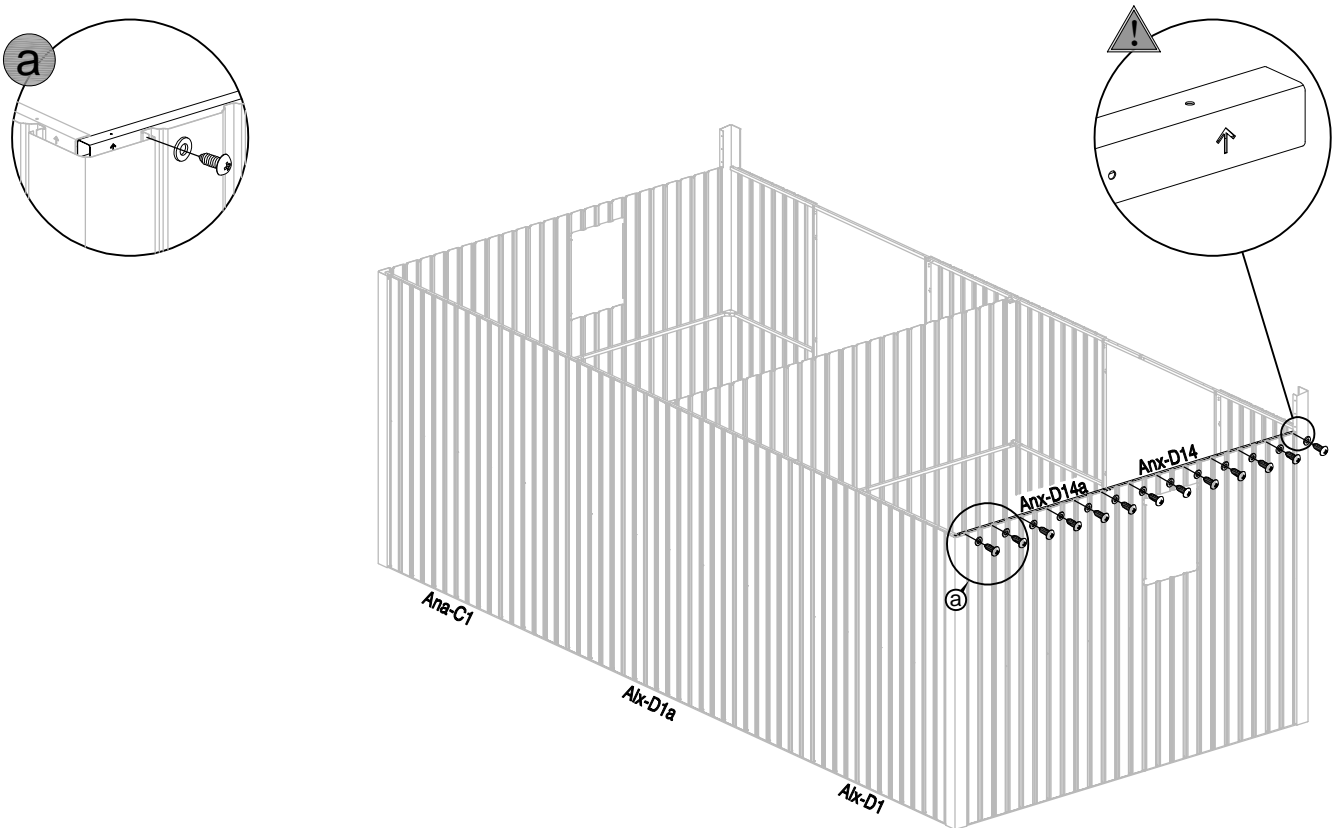

51



Aix-D41 x26



Aix-D40 x26

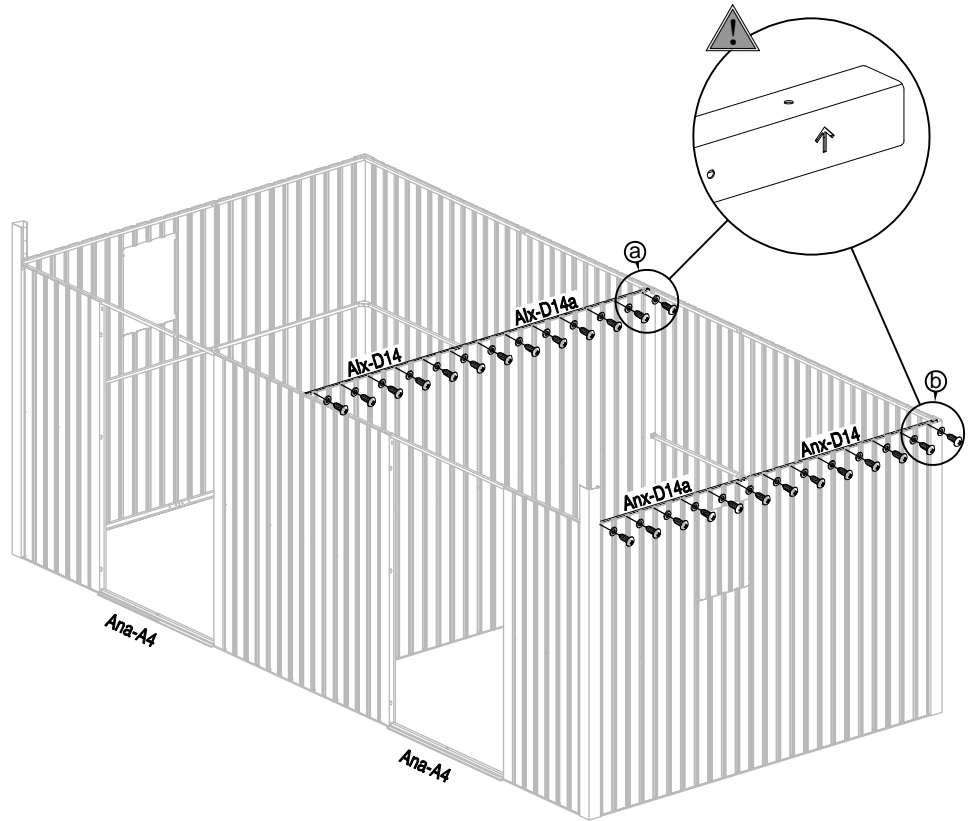
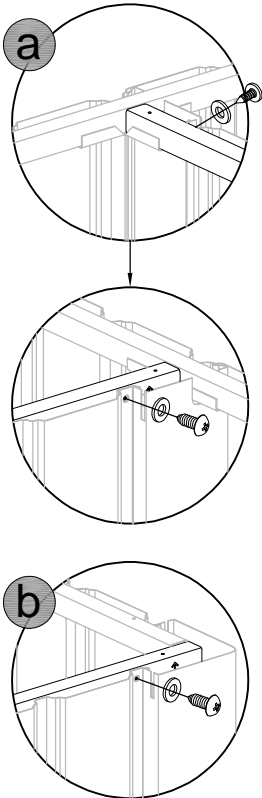

52

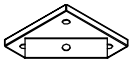

Ab-4 x2



Aix-D41 x6

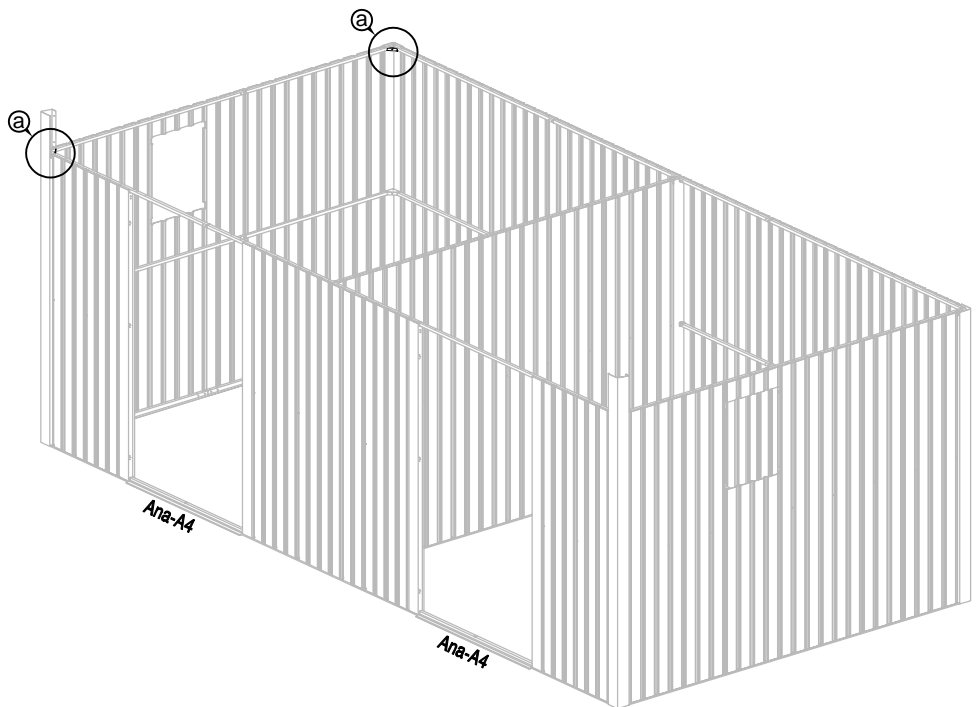
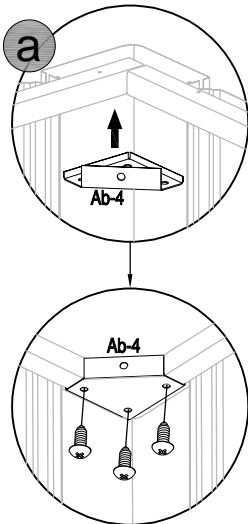

53

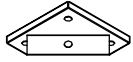

Ab-4 x2



Alx-D41 x10

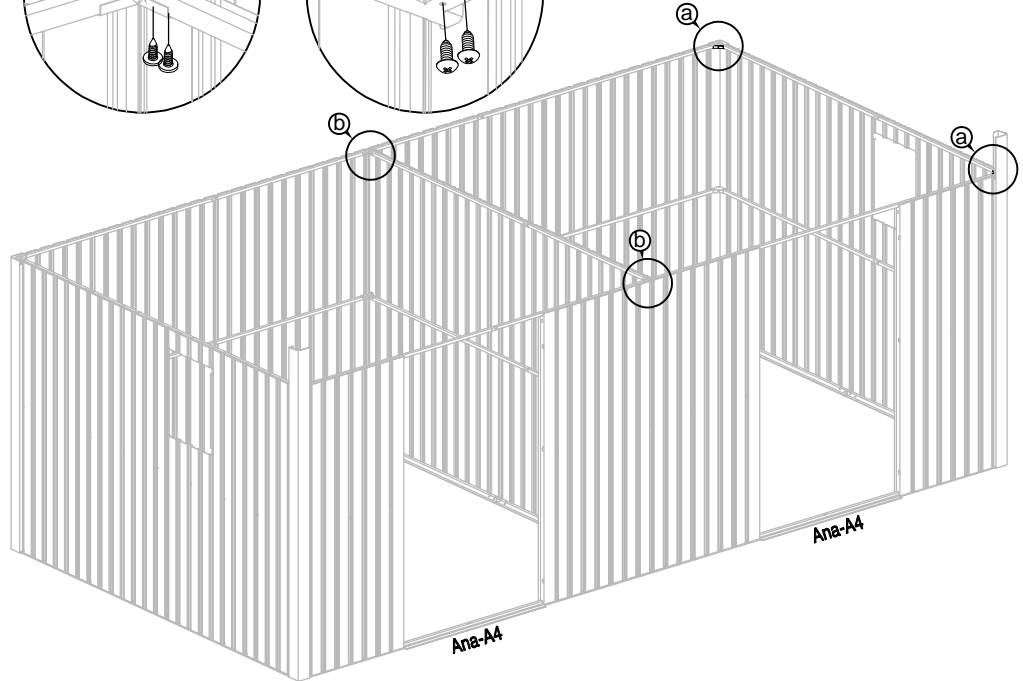
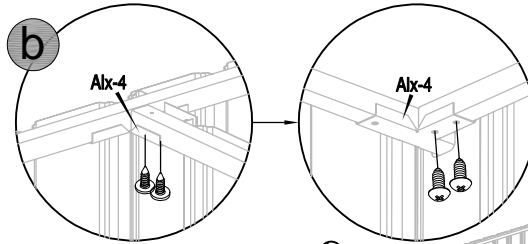
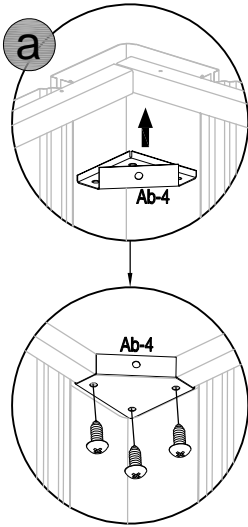

54

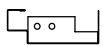





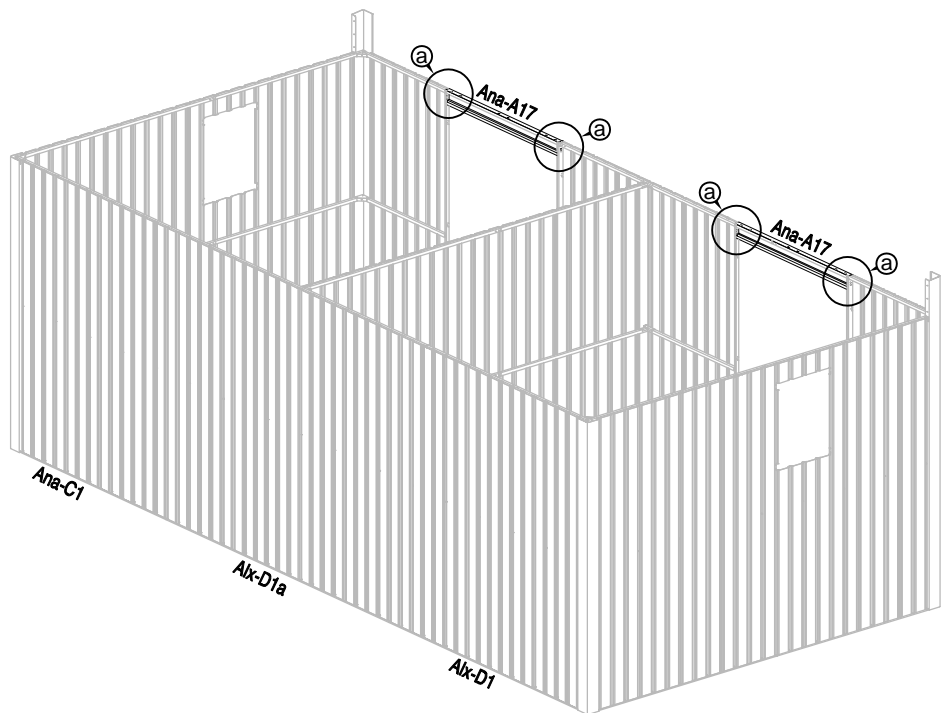
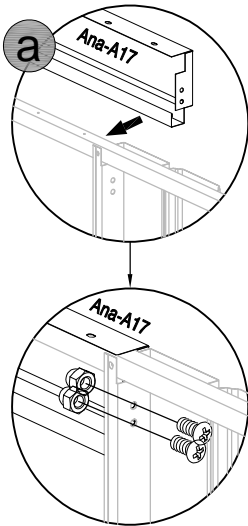

Ana-A17 x2



Alx-D44 x8





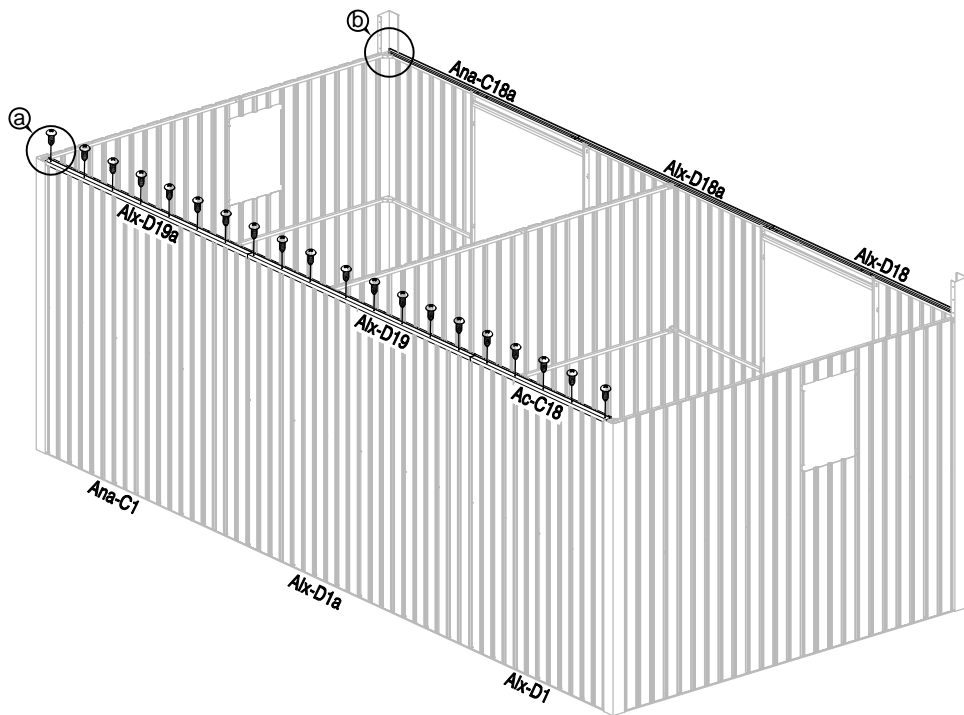
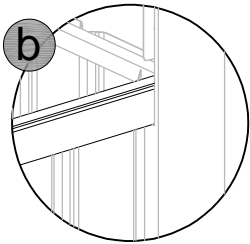
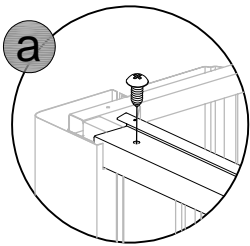

55	 Ana-C18a x1	 Alx-D18 x1	 Alx-D18a x1	 Ac-C18 x1	 Alx-D19 x1	 Alx-D19a x1	 Alx-D41 x20	
-----------	--	---	--	--	---	--	--	--

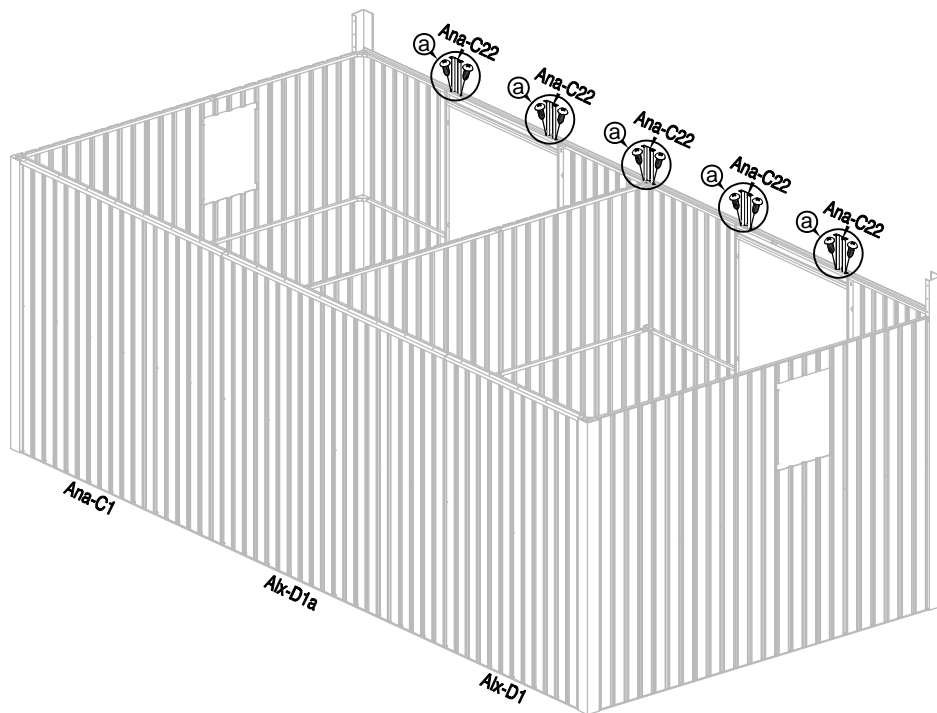
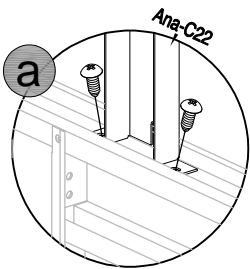



56	 Ana-C22 x5	 Alx-D41 x10	
-----------	---	--	--

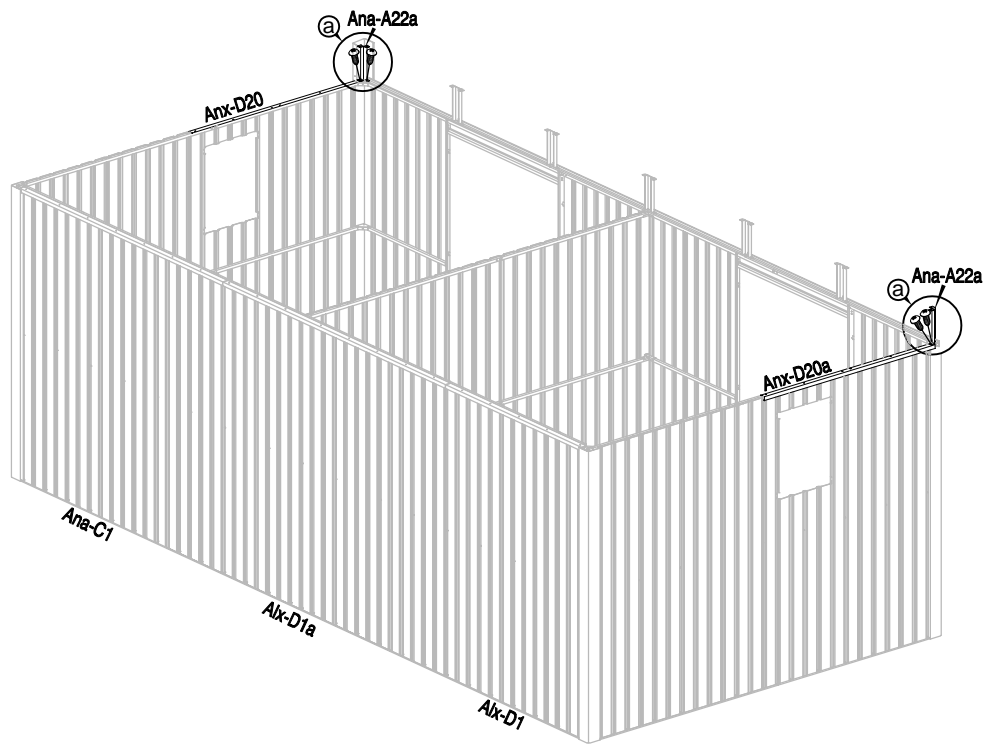
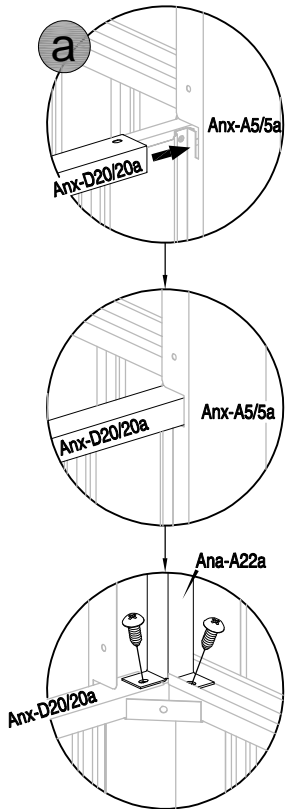

57	 Ana-A22a x2	 Anx-D20 x1	 Anx-D20a x1	 Alx-D41 x4	
----	--	---	--	--	--

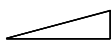
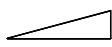
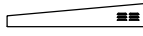
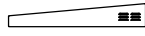

58	 Anx-D21b x1	 Anx-D21c x1	 Anx-D21 x1	 Anx-D21a x1	 Alx-D46 x4	
----	--	--	---	---	---	--

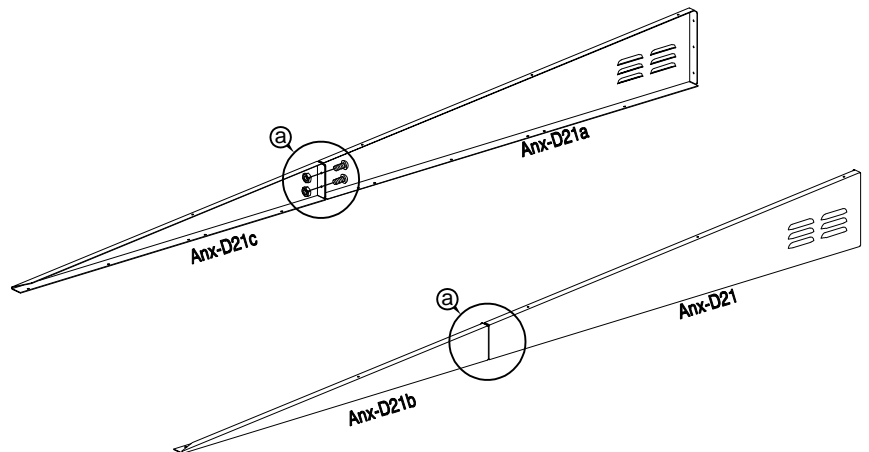
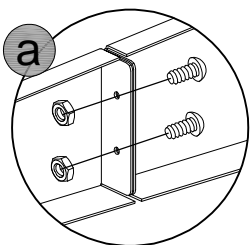
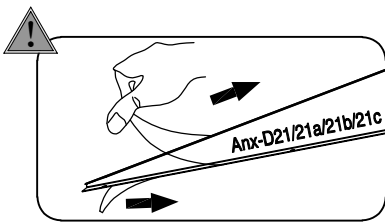

59

Anx-D20 x2

Anx-D20a x2

Aix-D41 x6

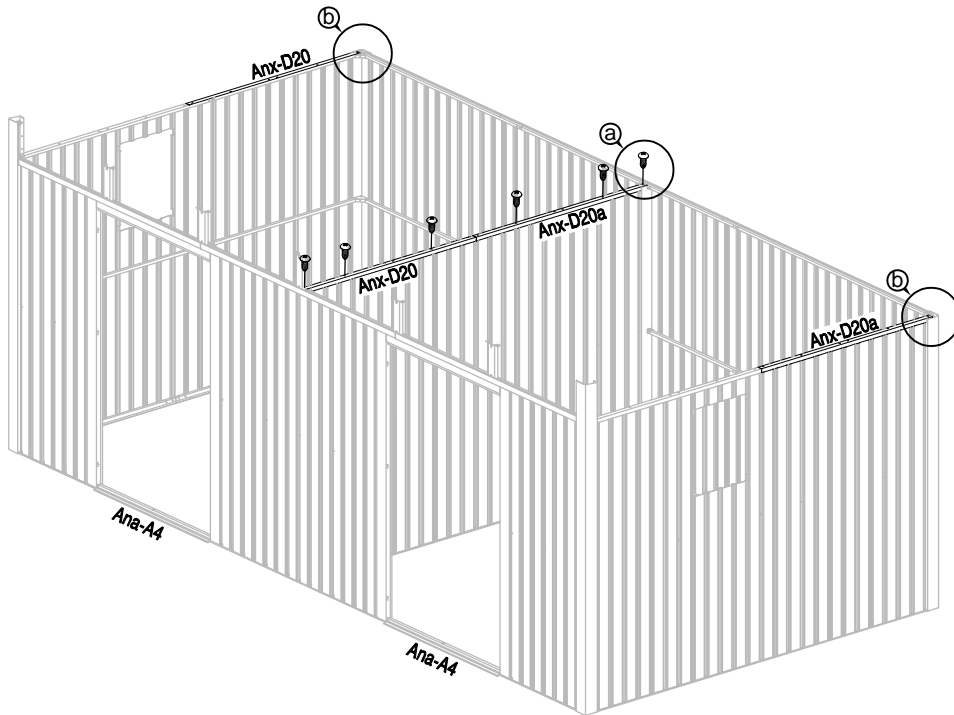
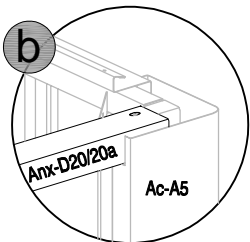
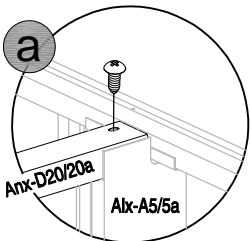





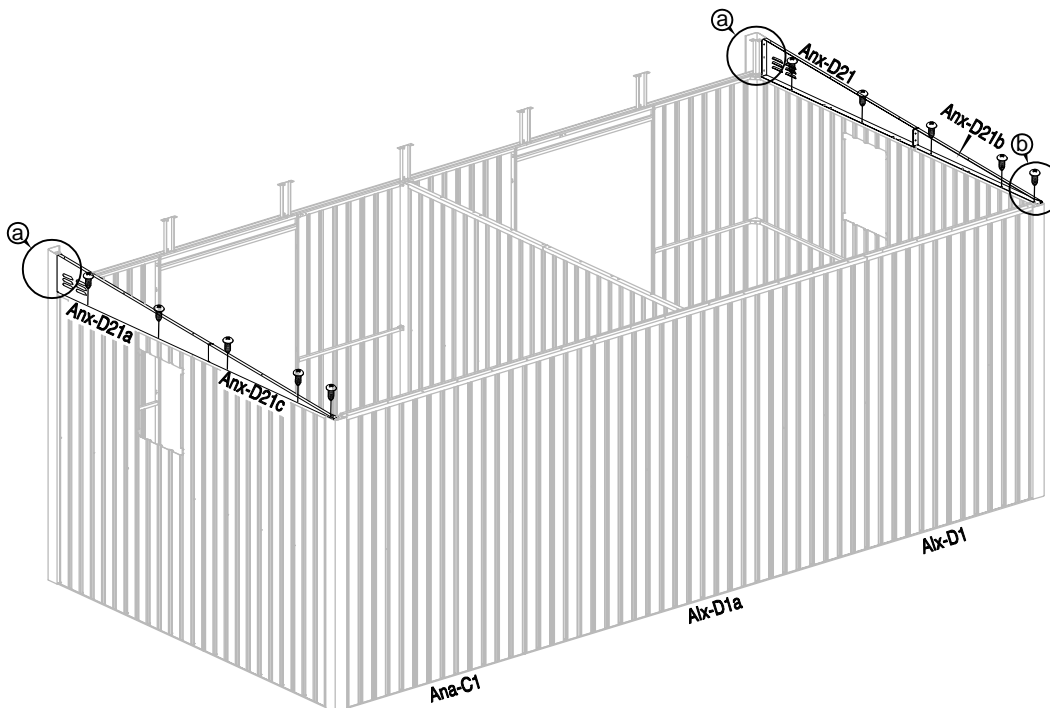
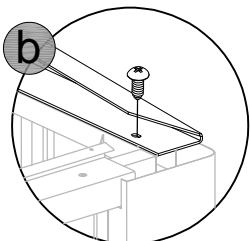
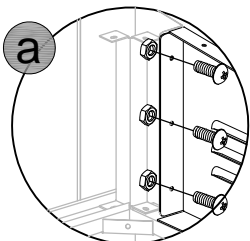

60

Aix-D41 x10

Aix-D46 x6

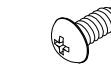

61	 Anx-D22 x2	 Anx-D22a x2	 Anx-D22b x2	 Alx-D22 x1	 Alx-D22a x1	 Alx-D22b x1	 Alx-D41 x18	
-----------	---	--	--	---	--	--	--	--

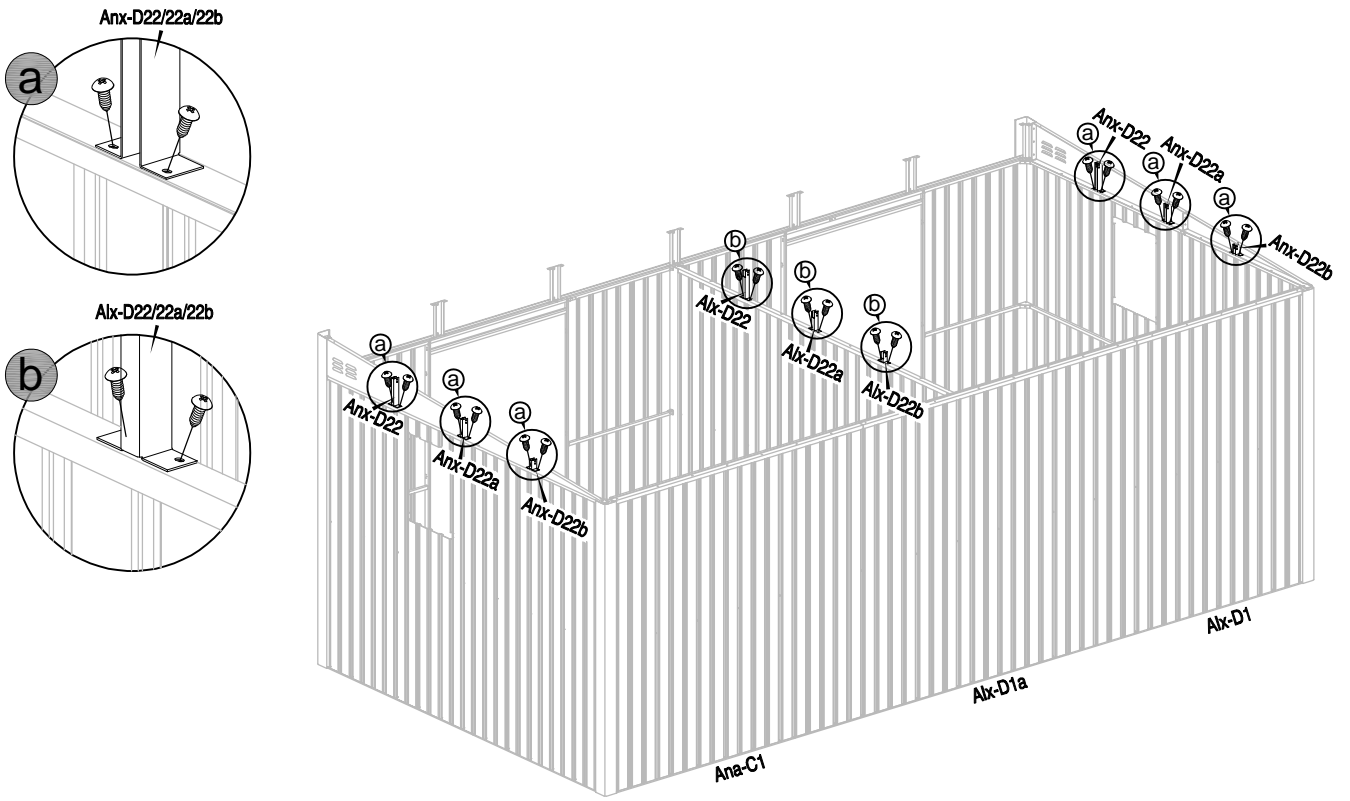

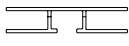
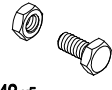

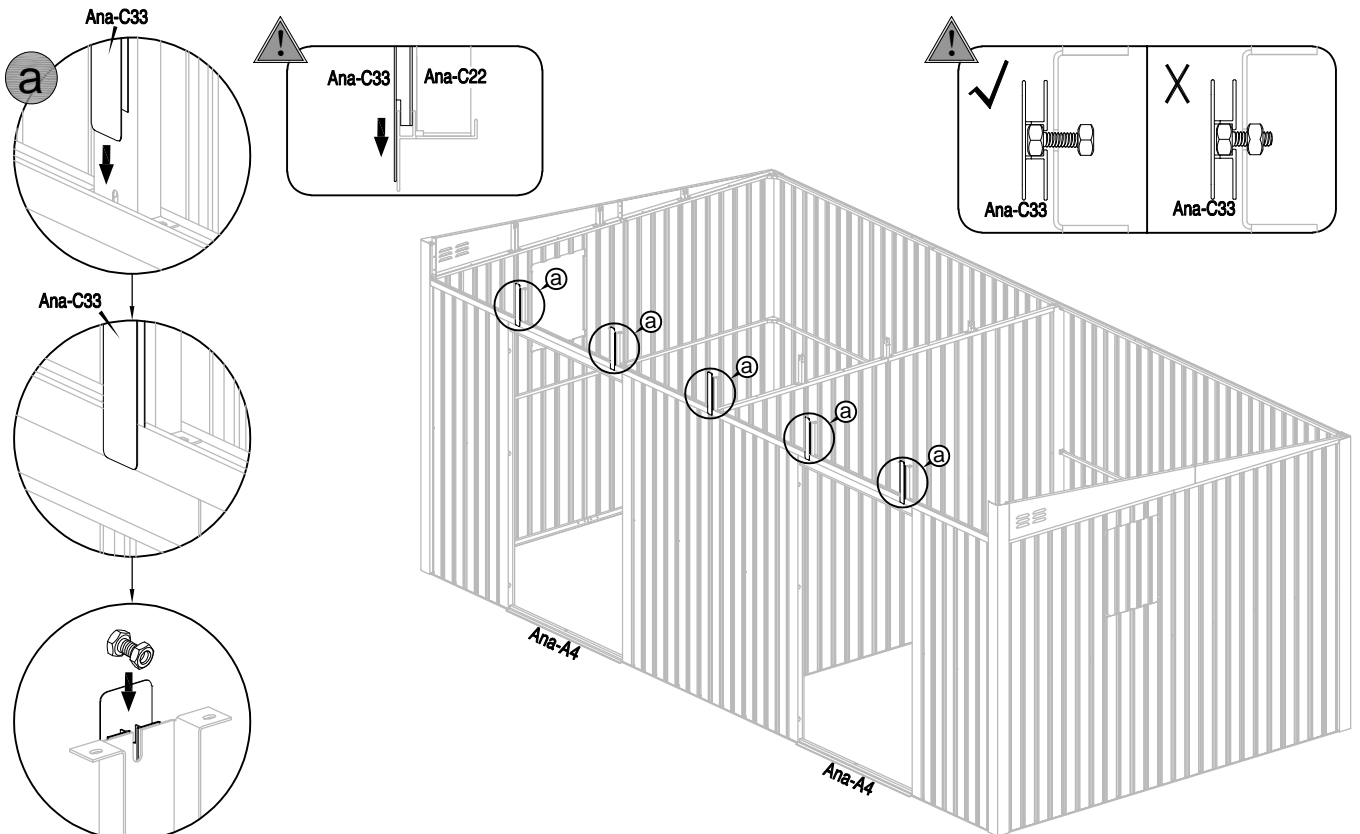
62	 Ana-C33 x5	 Alx-D42 x5	
-----------	---	---	--



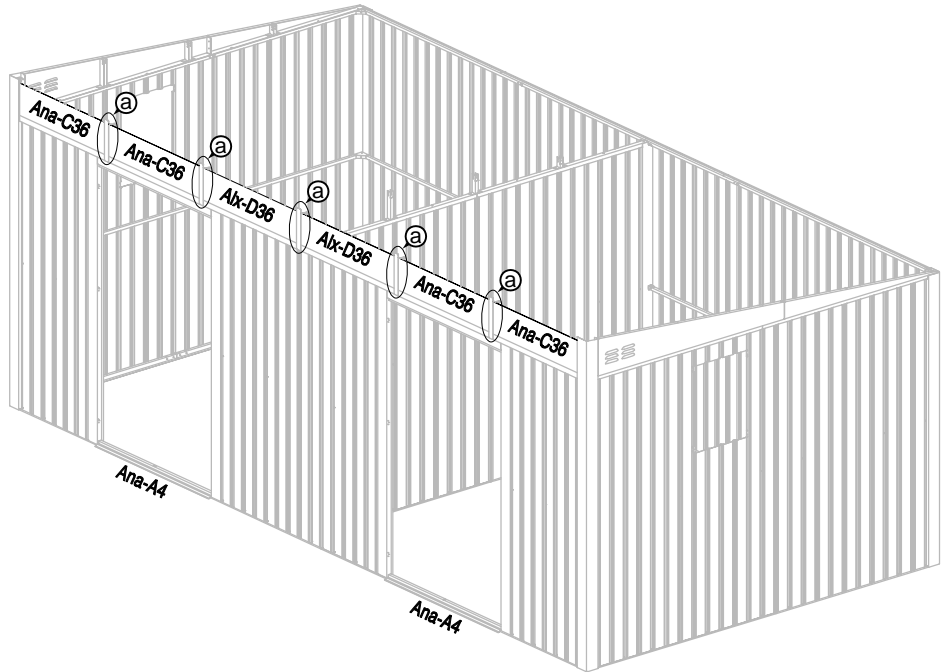
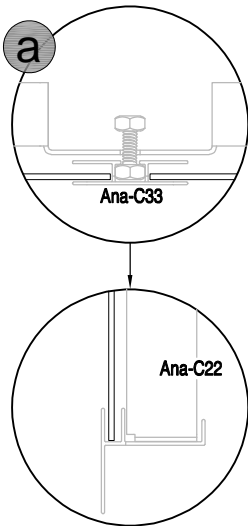
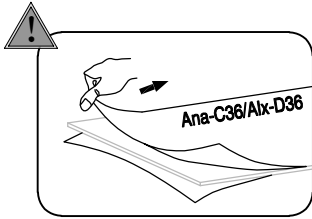



63	 Ana-C36 x4	 Alx-D36 x2	
----	---	---	--

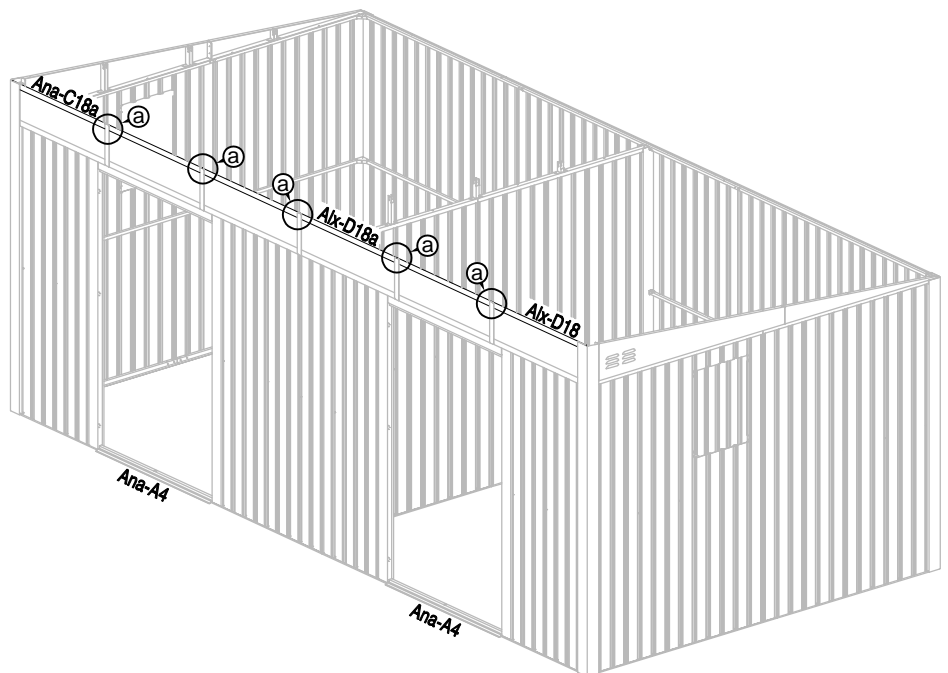
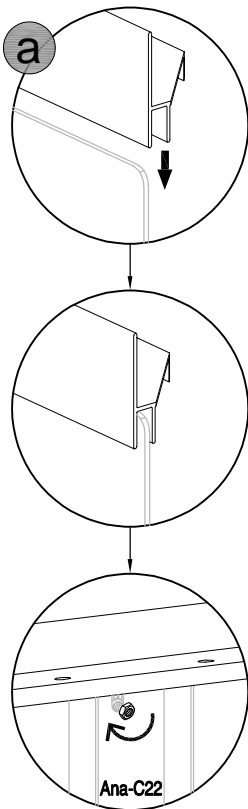

64	 Ana-C18a x1	 Alx-D18 x1	 Alx-D18a x1	
----	--	---	--	--



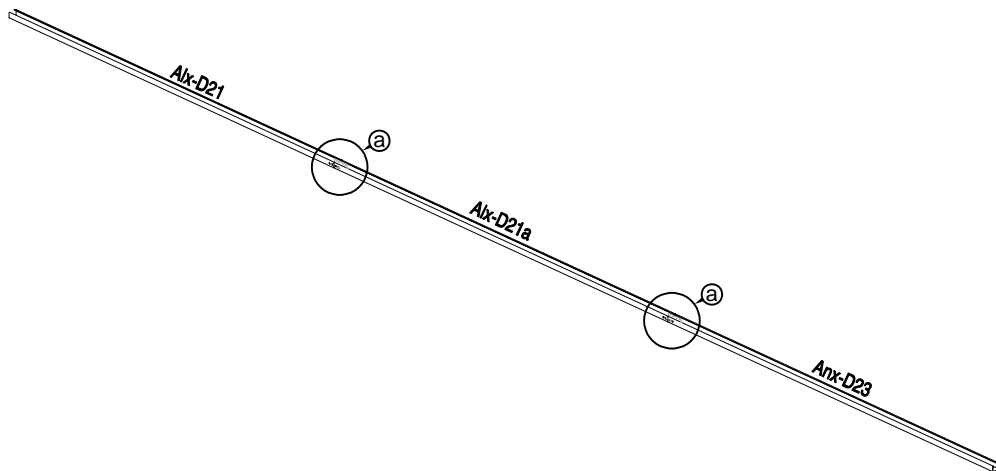
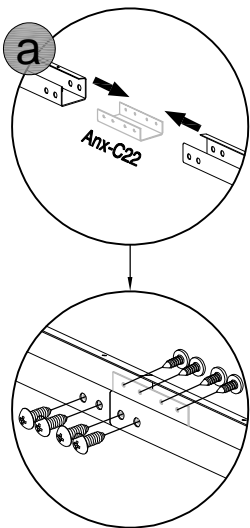

65	 Anx-D23 x1	 Alx-D21 x1	 Alx-D21a x1	 Anx-C22 x2	 Alx-D41 x16	
----	---	---	--	--	--	--

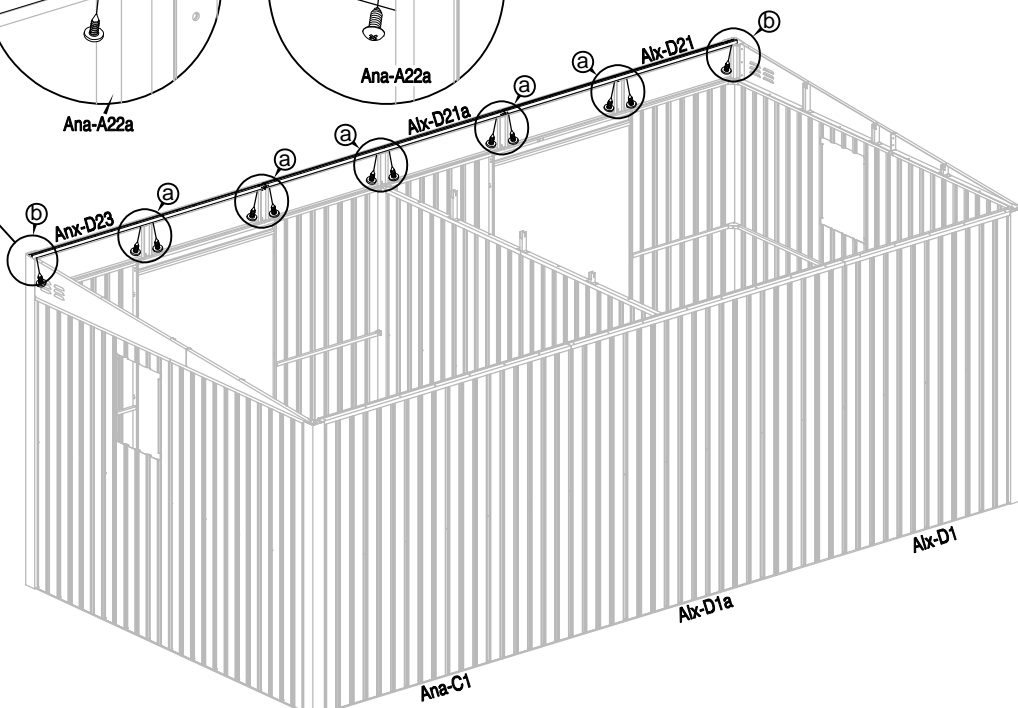
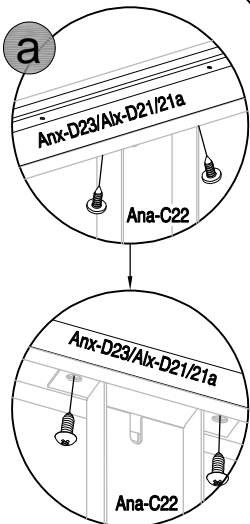
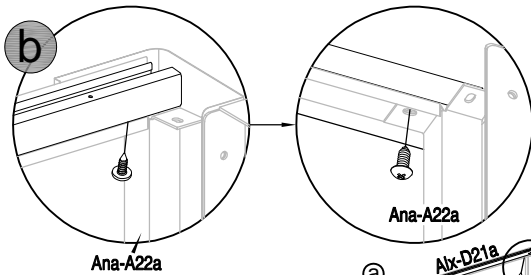
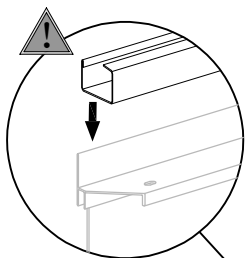

66	 Alx-D41 x12	
----	--	--



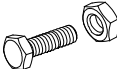

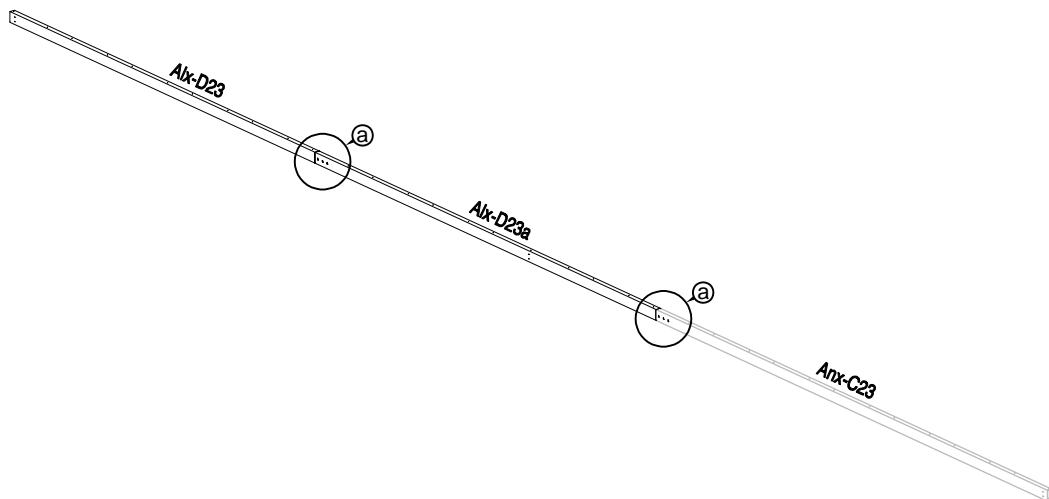
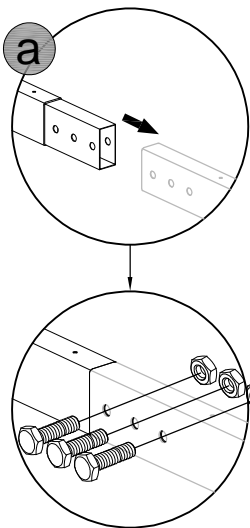
67	 Anx-C23 x3	 Alx-D23 x3	 Alx-D23a x3	 Alx-D48 x18	
----	---	---	--	---	--



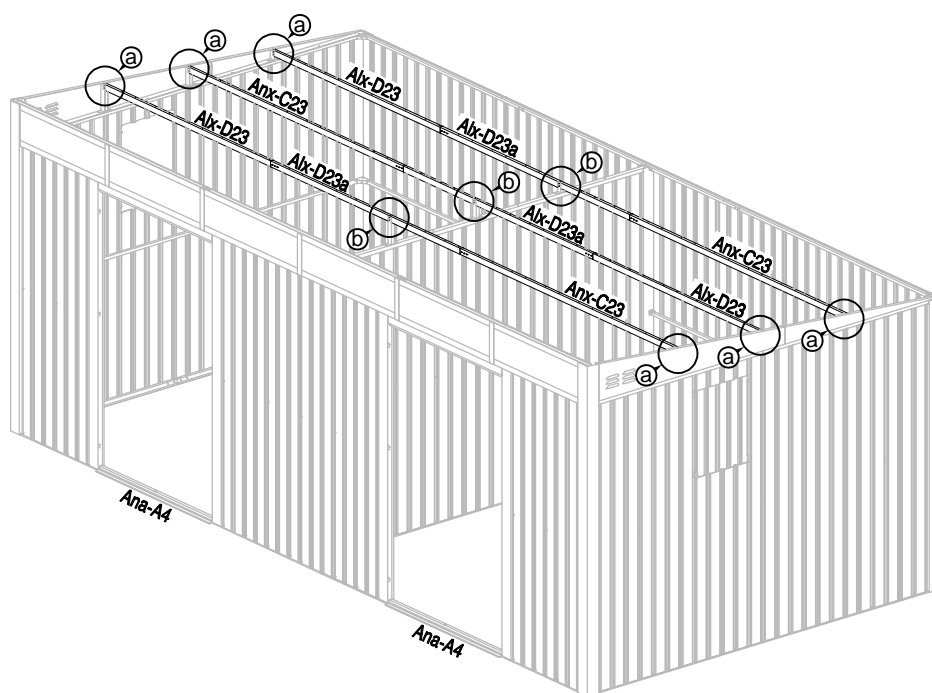
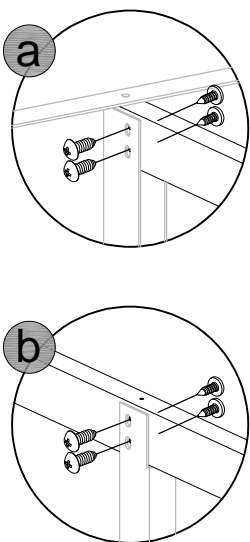

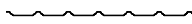
68	 Alx-D41 x36	
----	--	--



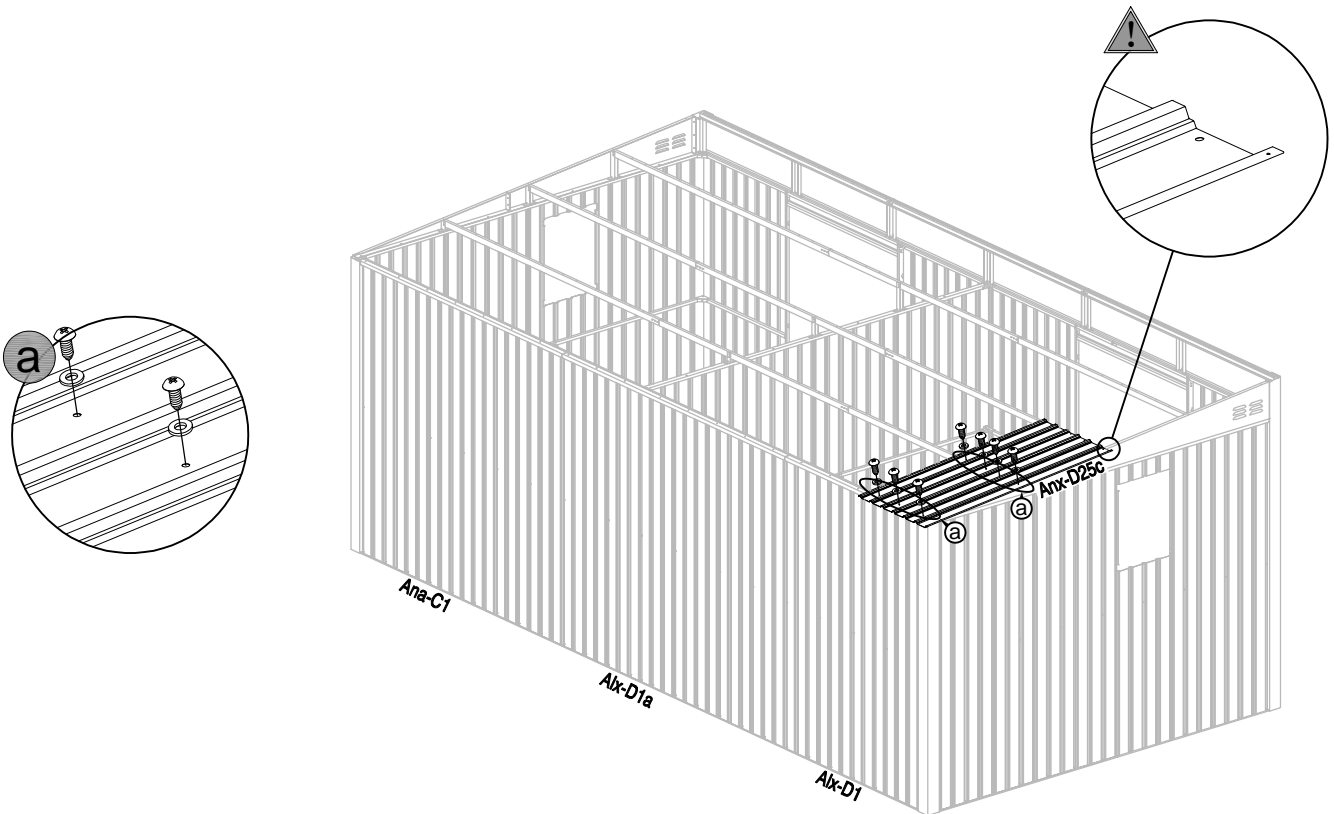

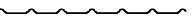
69	 Anx-D25c x1	 Alx-D41 x7	 Alx-D40 x7	
----	--	---	---	--



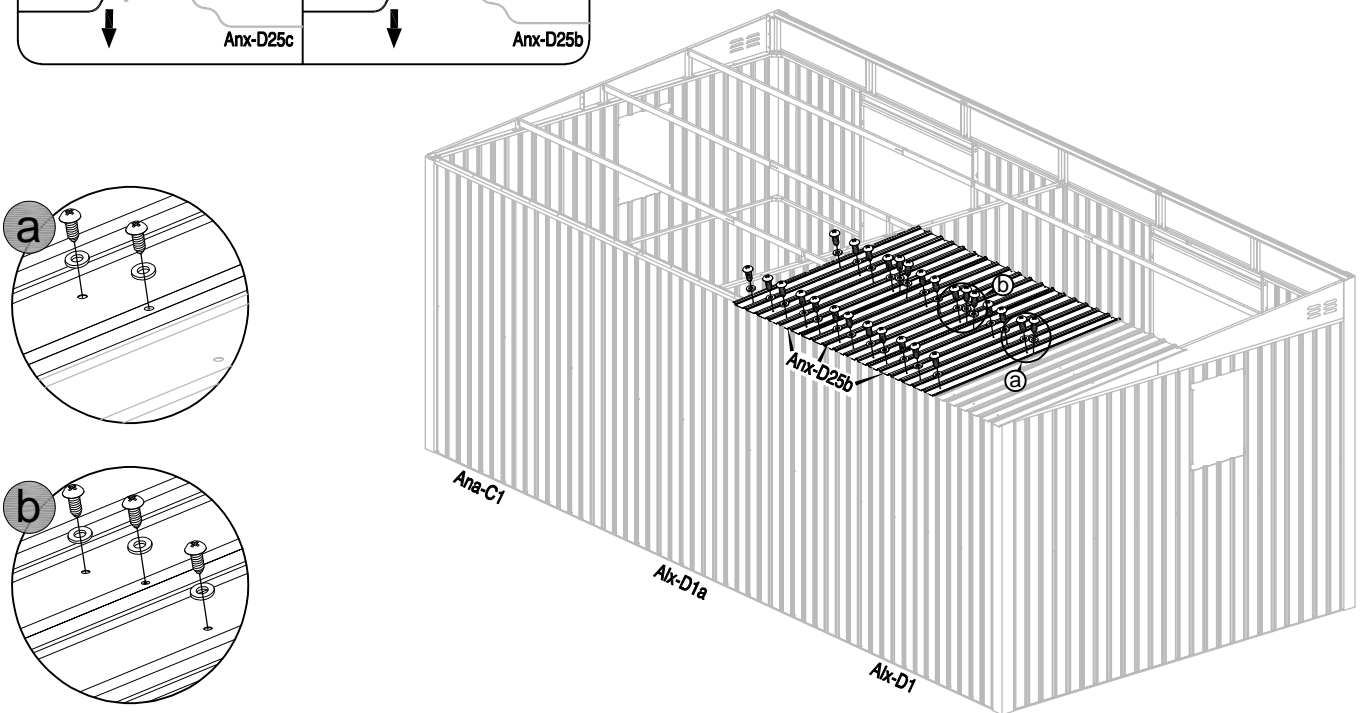
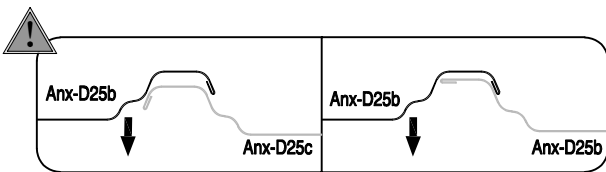

70	 Anx-D25b x3	 Alx-D41 x27	 Alx-D40 x27	
----	--	--	--	--



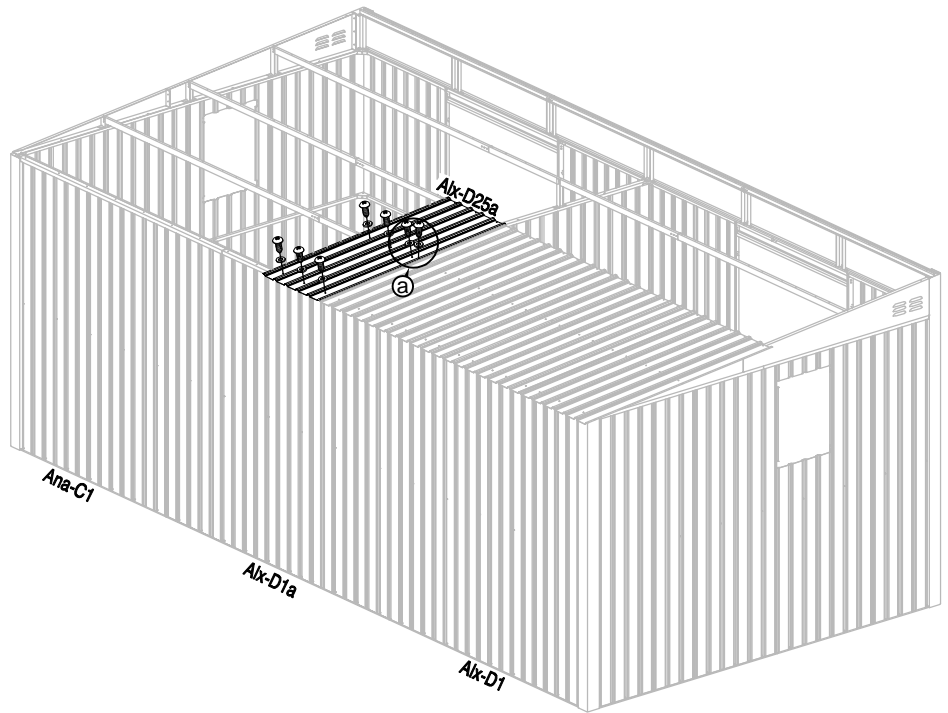
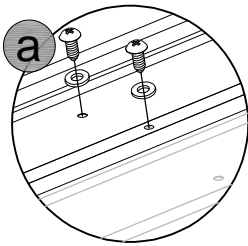
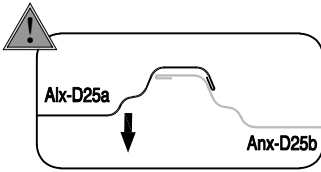

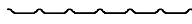
71	 Alx-D25a x1	 Alx-D41 x7	 Alx-D40 x7	
----	--	---	---	--



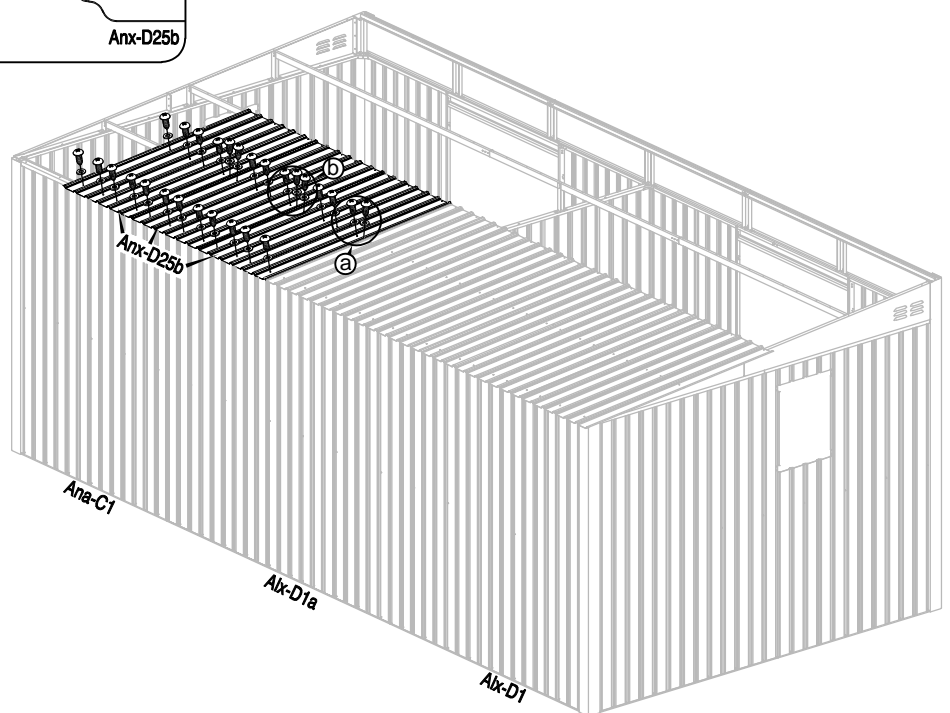
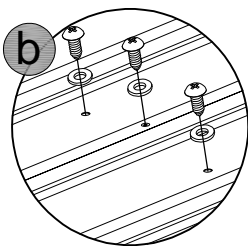
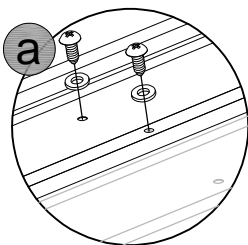
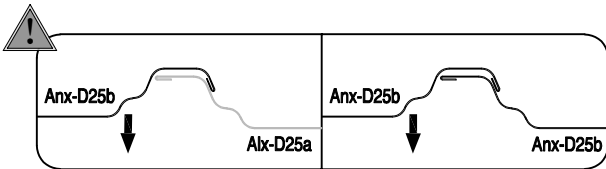

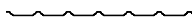

72	 Anx-D25b x3	 Alx-D41 x27	 Alx-D40 x27	
----	--	--	--	--

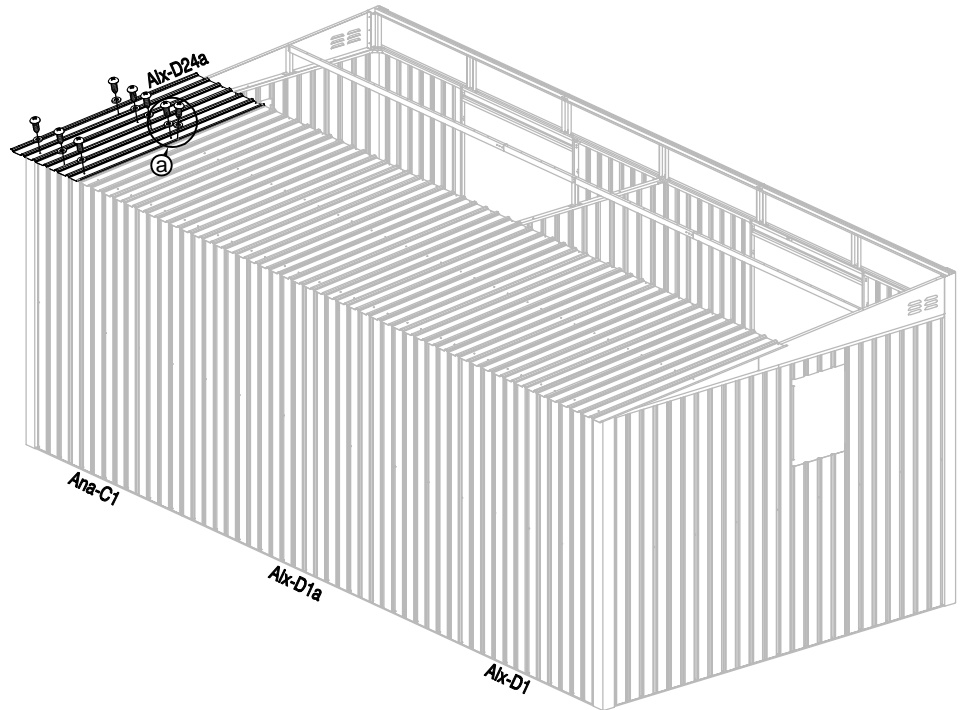
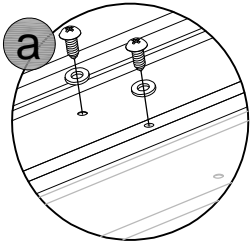
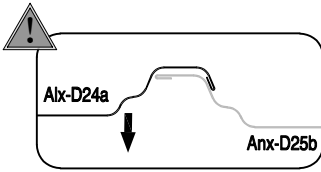

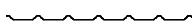

73	 Alx-D24a x1	 Alx-D41 x8	 Alx-D40 x8	
----	--	---	---	--



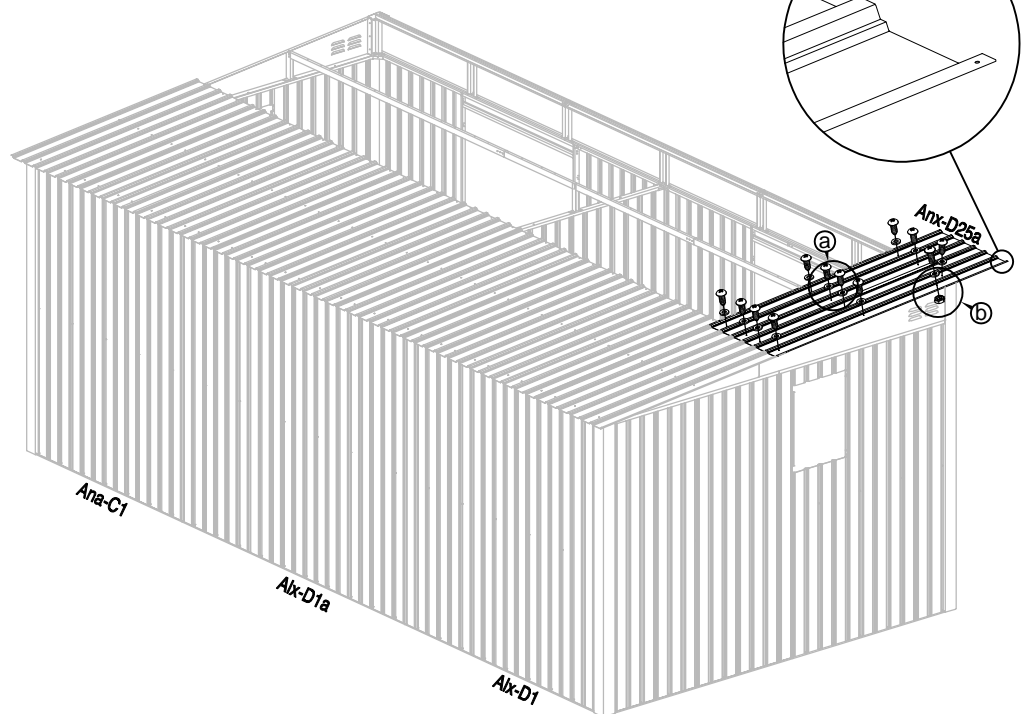
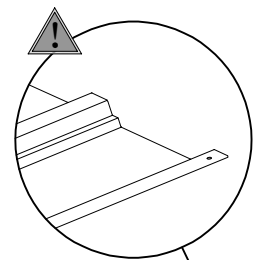
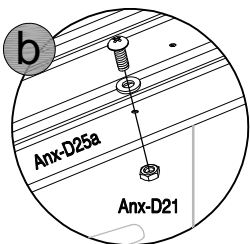
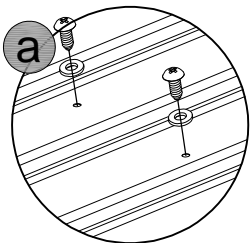



74	 Anx-D25a x1	 Alx-D41 x11	 Alx-D40 x12	 Alx-D46 x1
----	--	--	--	--

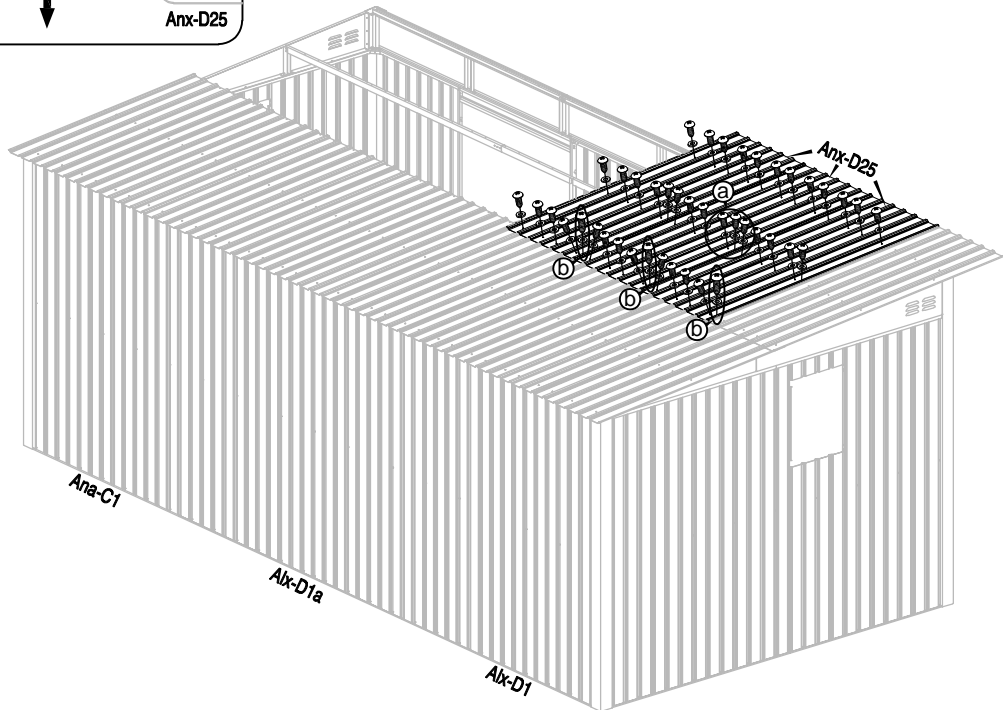
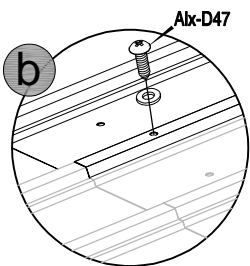
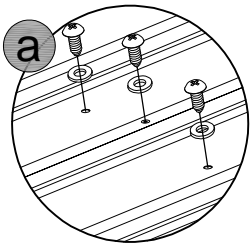





75	 Anx-D25 x3	 Alx-D41 x39	 Alx-D40 x42	 Alx-D47 x3	
----	---	--	--	--	--

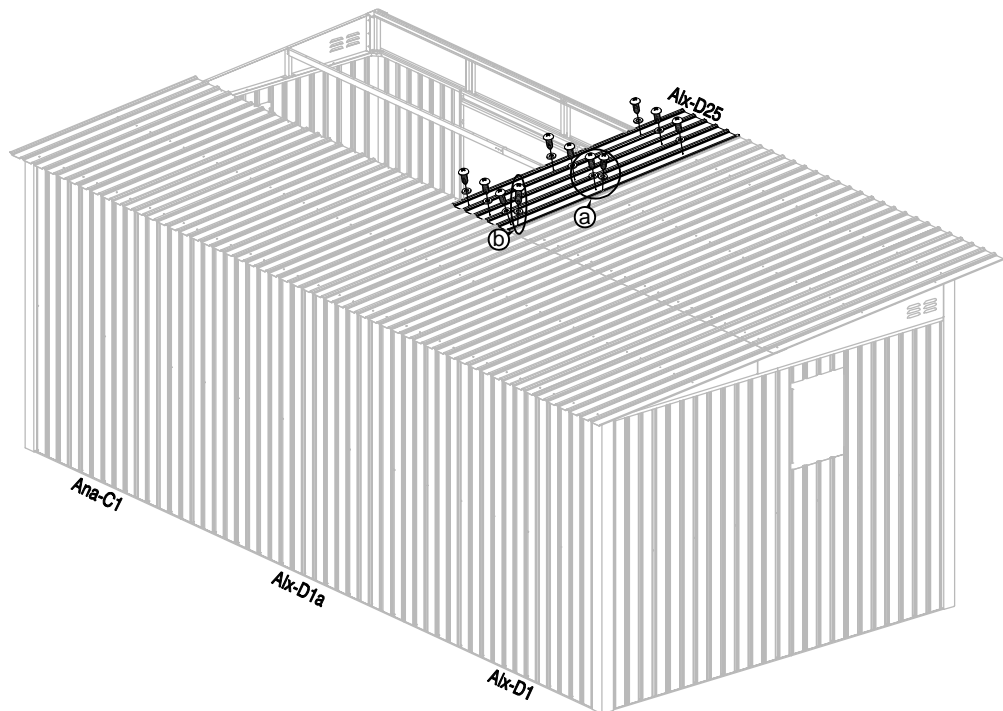
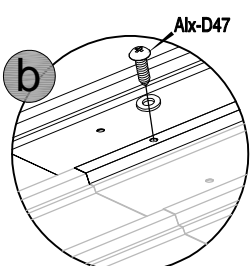
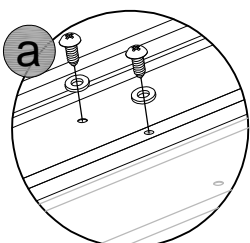
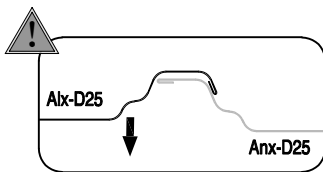





76	 Alx-D25 x1	 Alx-D41 x10	 Alx-D40 x11	 Alx-D47 x1	
----	---	--	--	--	--

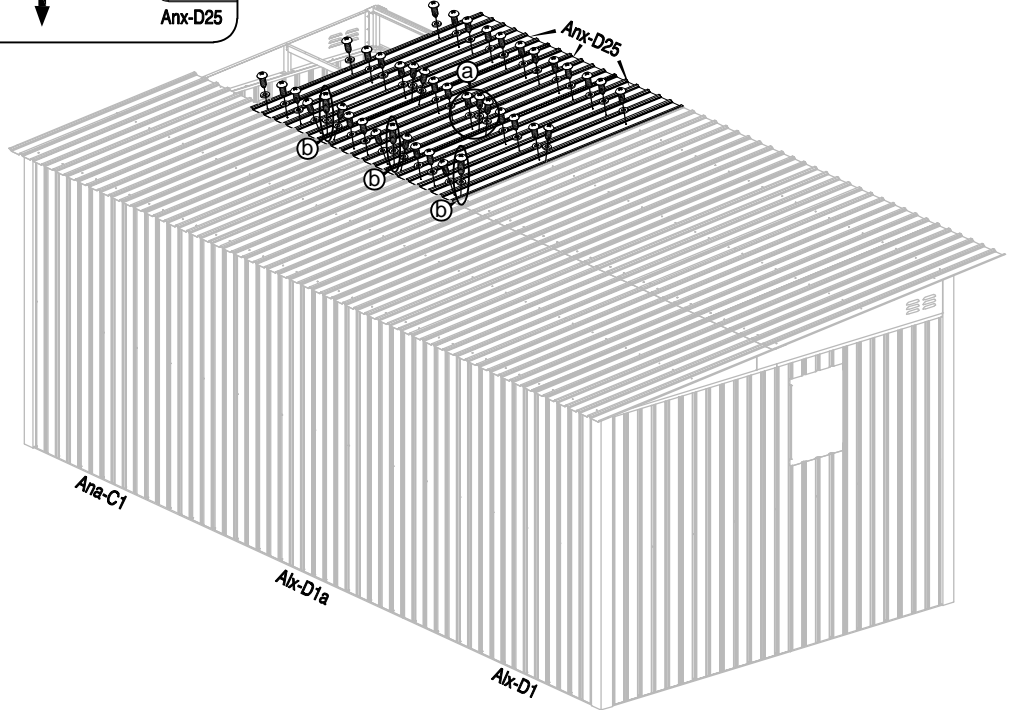
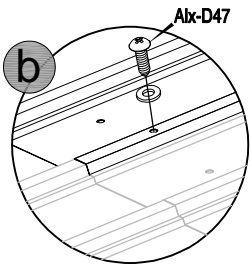
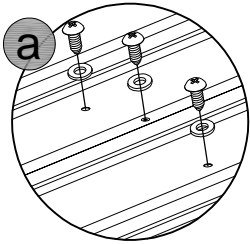
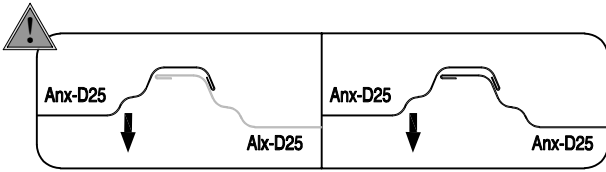

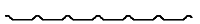



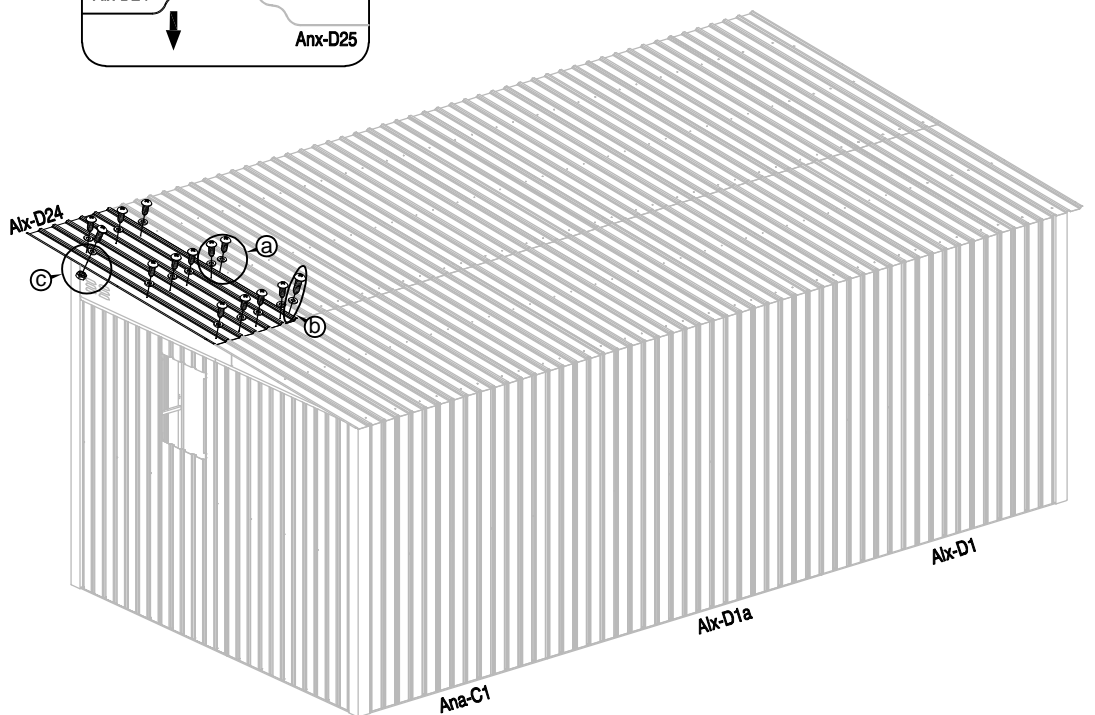
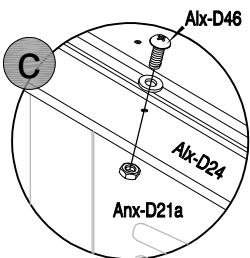
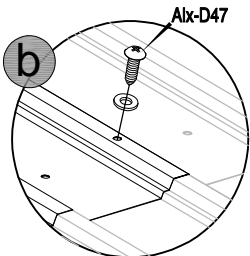
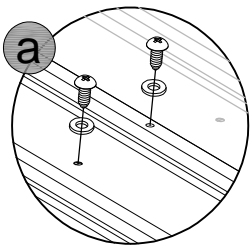
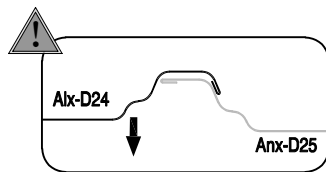

77	 Anx-D25 x3	 Alx-D41 x39	 Alx-D40 x42	 Alx-D47 x3	
----	---	--	--	--	--



78	 Alx-D24 x1	 Alx-D41 x12	 Alx-D40 x14	 Alx-D46 x1	 Alx-D47 x1
----	---	--	--	--	---





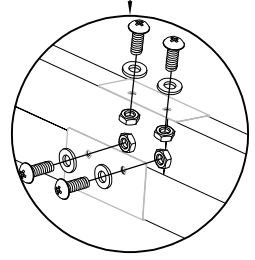
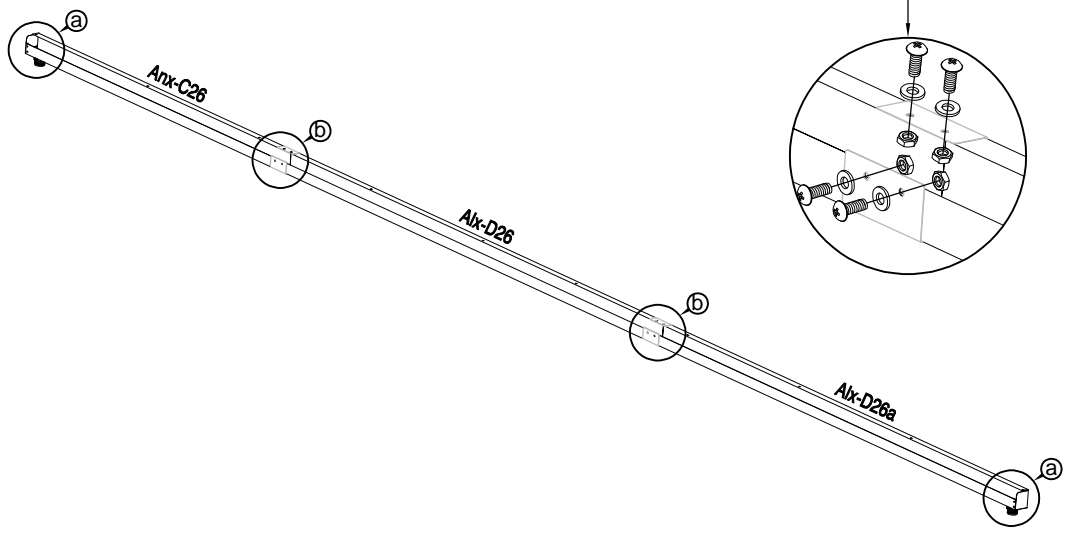
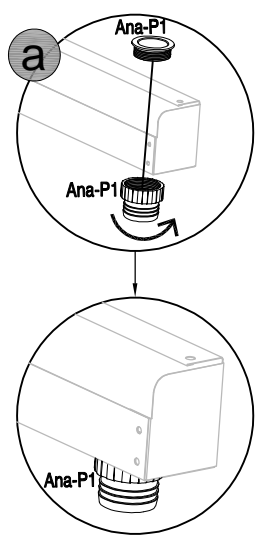
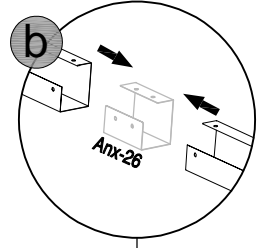
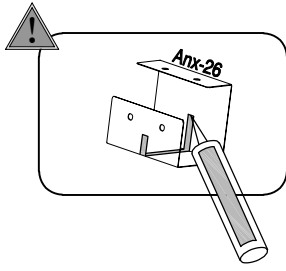

79	 Anx-C26 x1	 Aix-D26 x1	 Aix-D26a x1	 Anx-26 x2	 Ana-P1 x2	 Aix-D40 x8	 Aix-D46 x8	
-----------	---	---	--	--	--	---	---	--

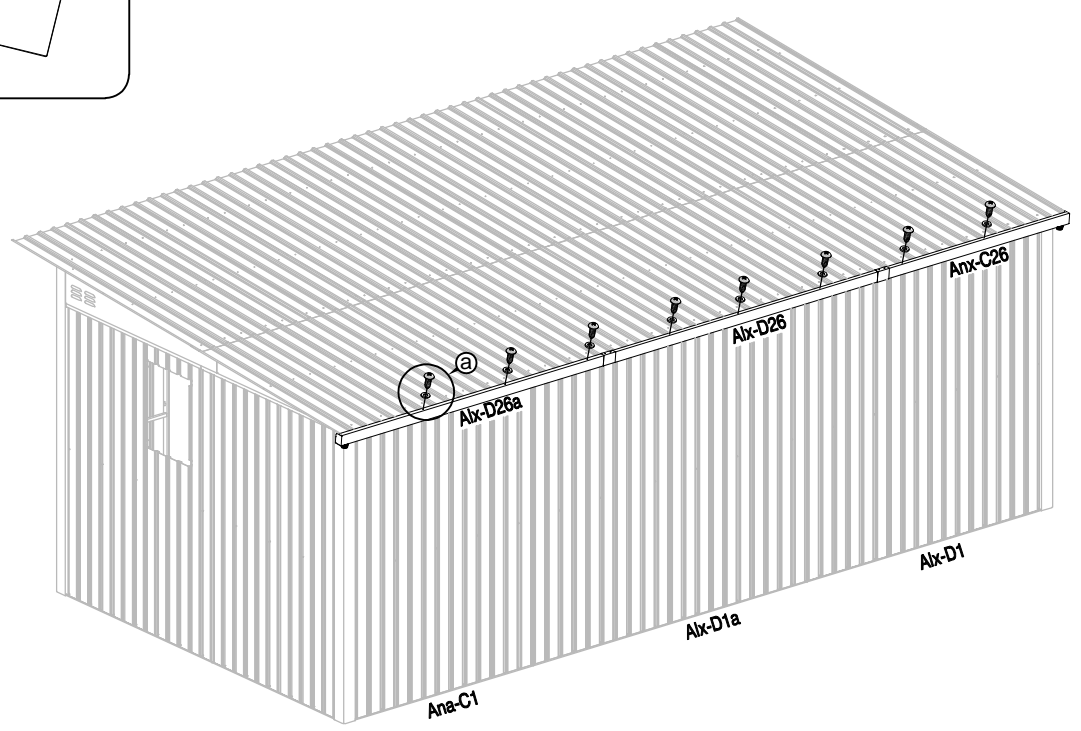
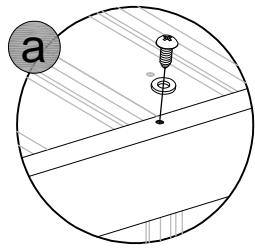
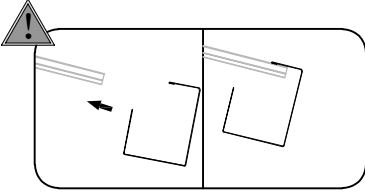

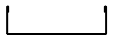
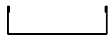
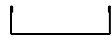



80	 Aix-D41 x8	 Aix-D40 x8	
-----------	---	---	--

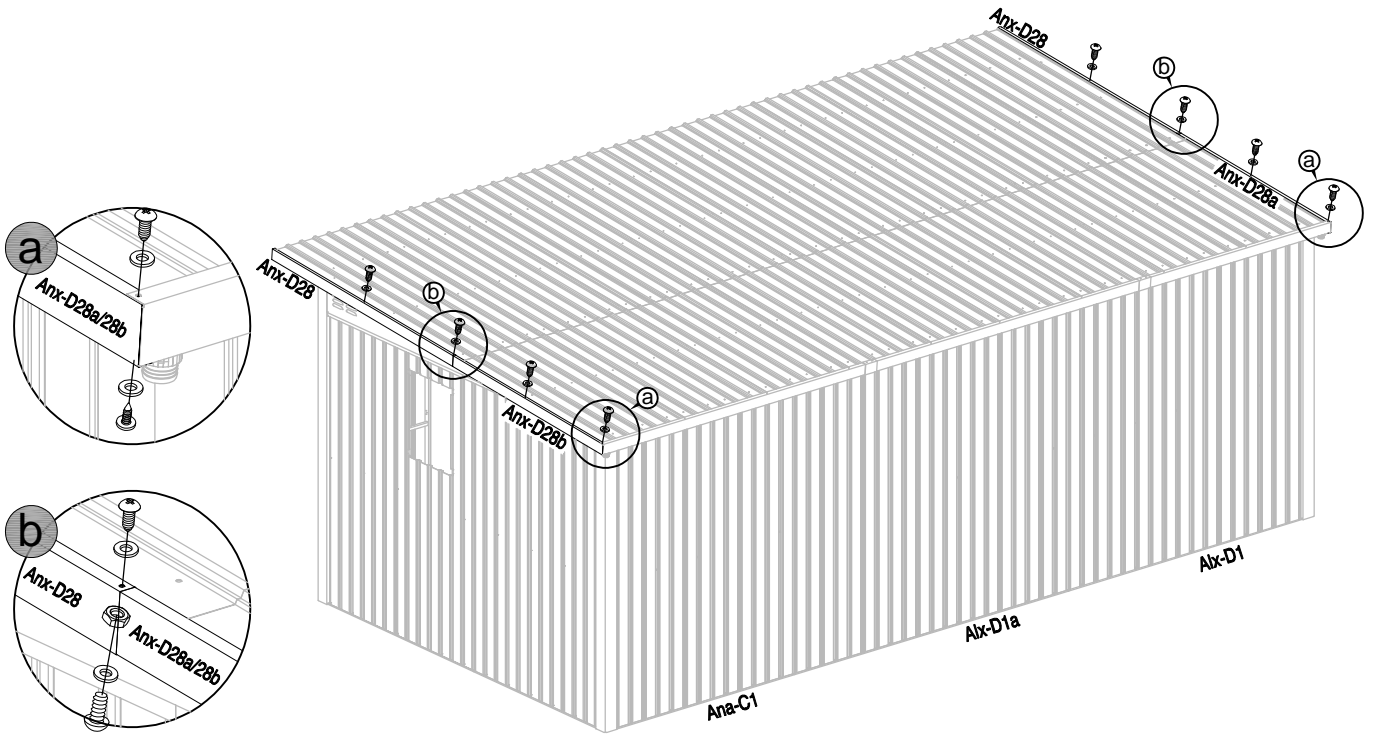

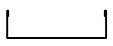
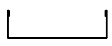
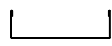
81						
	Anx-D28 x2	Anx-D28a x1	Anx-D28b x1	Alx-D41 x10	Alx-D40 x12	Alx-D46 x2



82						
	Alx-D27 x1	Alx-D27a x1	Alx-D27b x1	Alx-D41 x10	Alx-D40 x14	Alx-D46 x4

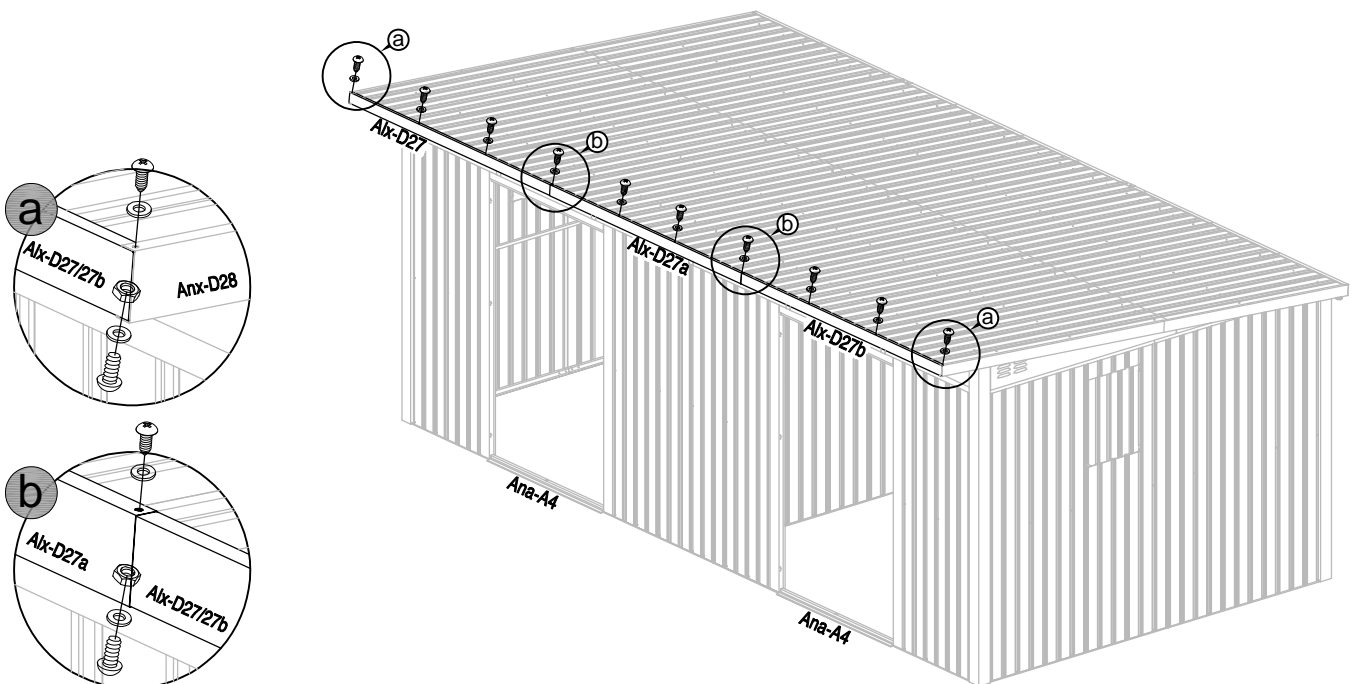

83

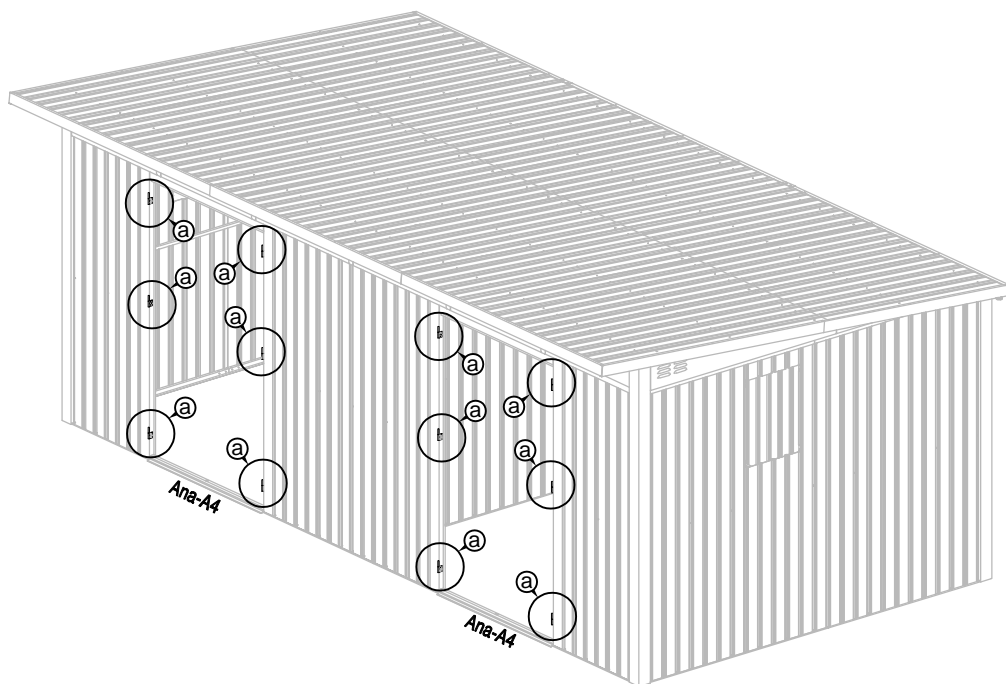
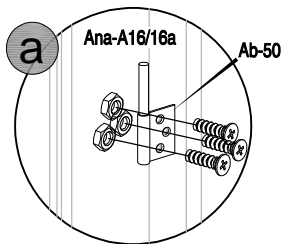
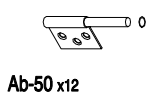

84

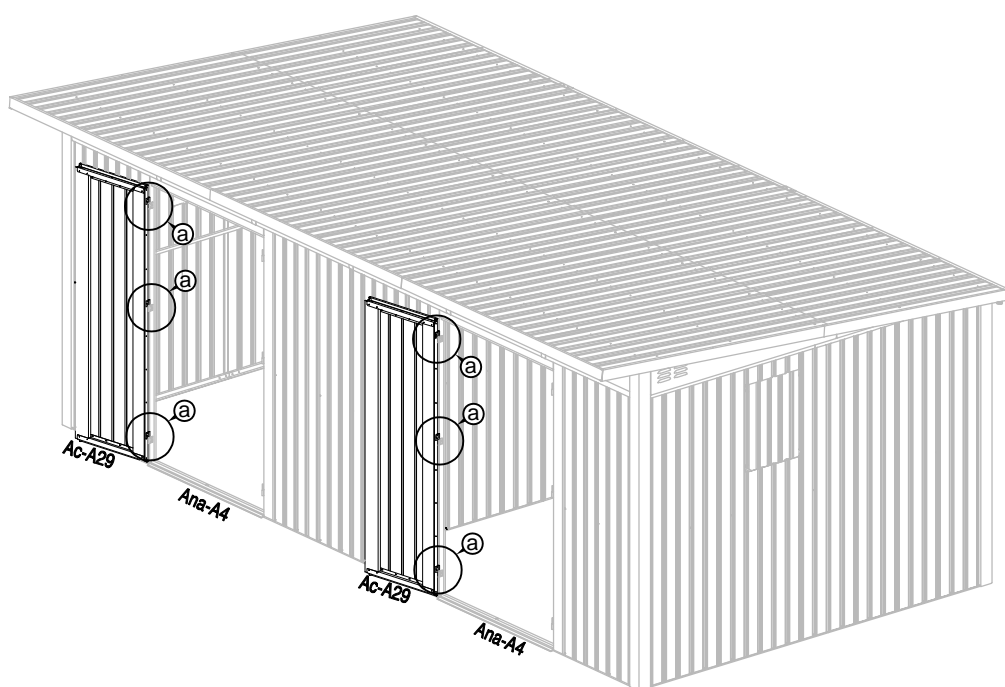
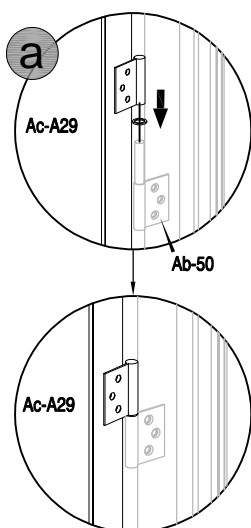
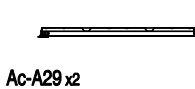

85

Ac-A29a x2

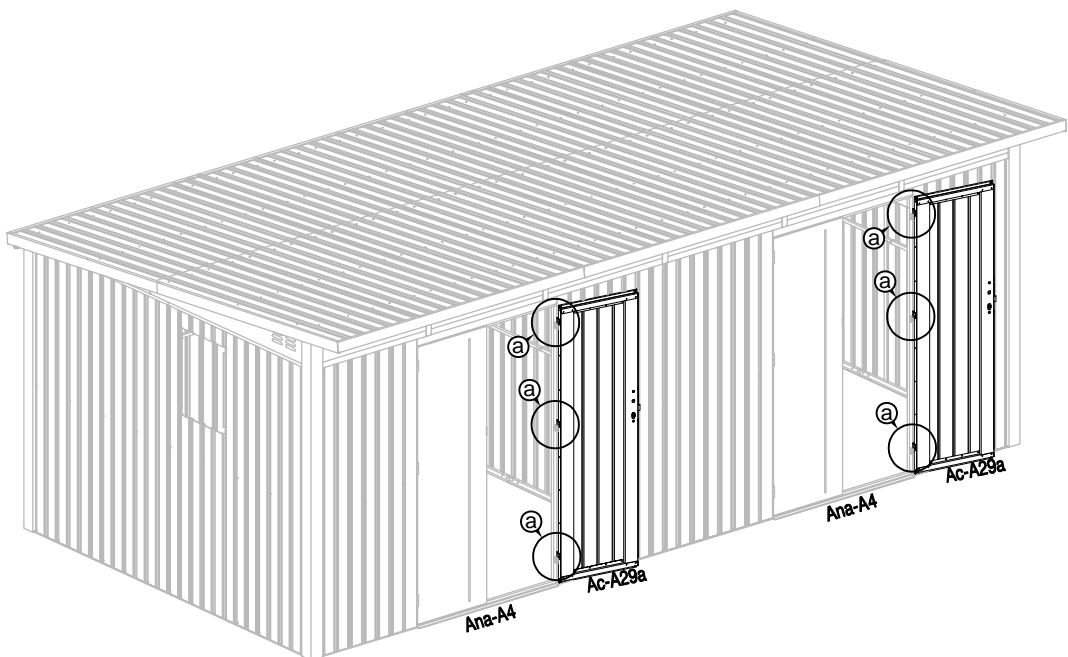
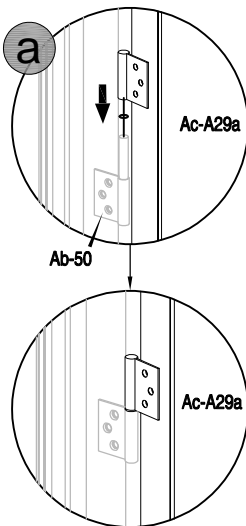
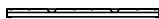

86

Ana-54 x2



Ana-55 x2



Ana-56 x2



Ana-57 x2



Ana-58 x6

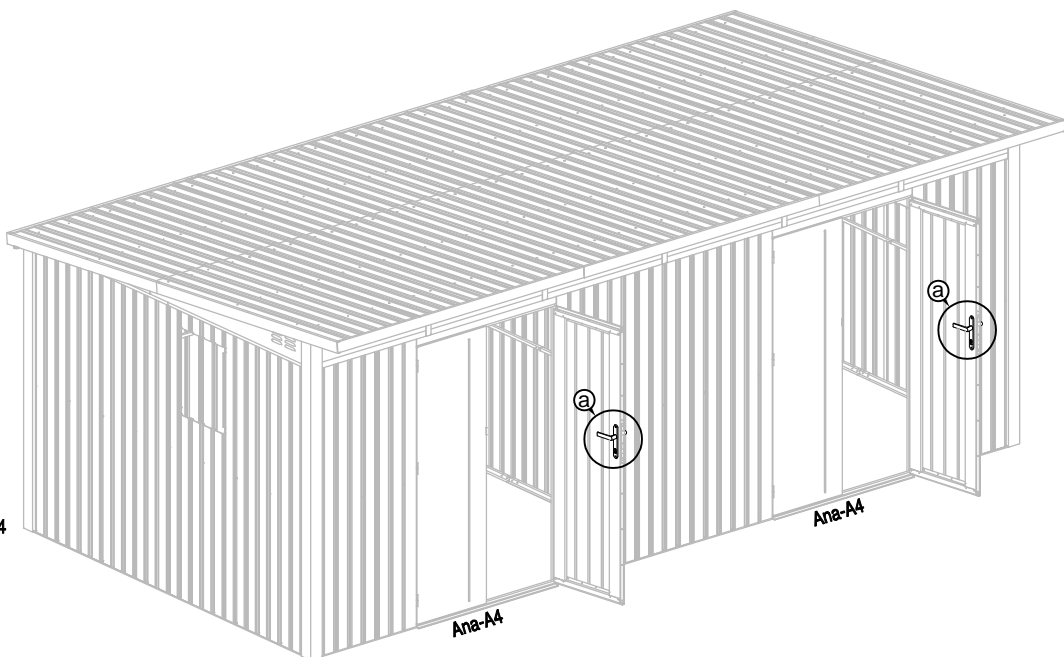
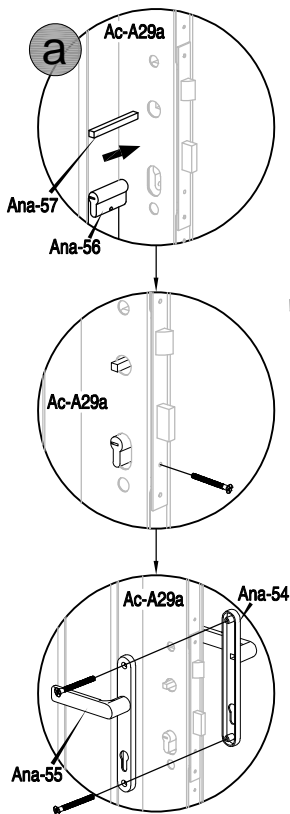

87



Ana-P6 x2



Alx-D41 x8

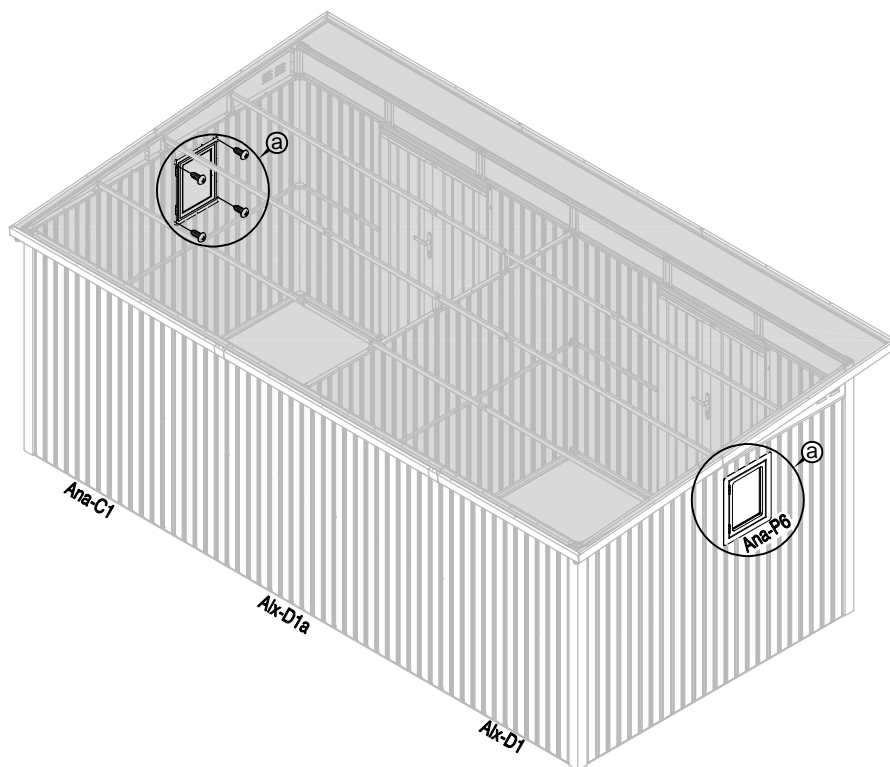
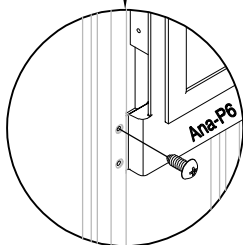
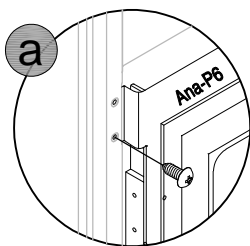

88



Ana-P7 x2



Alx-D41 x20

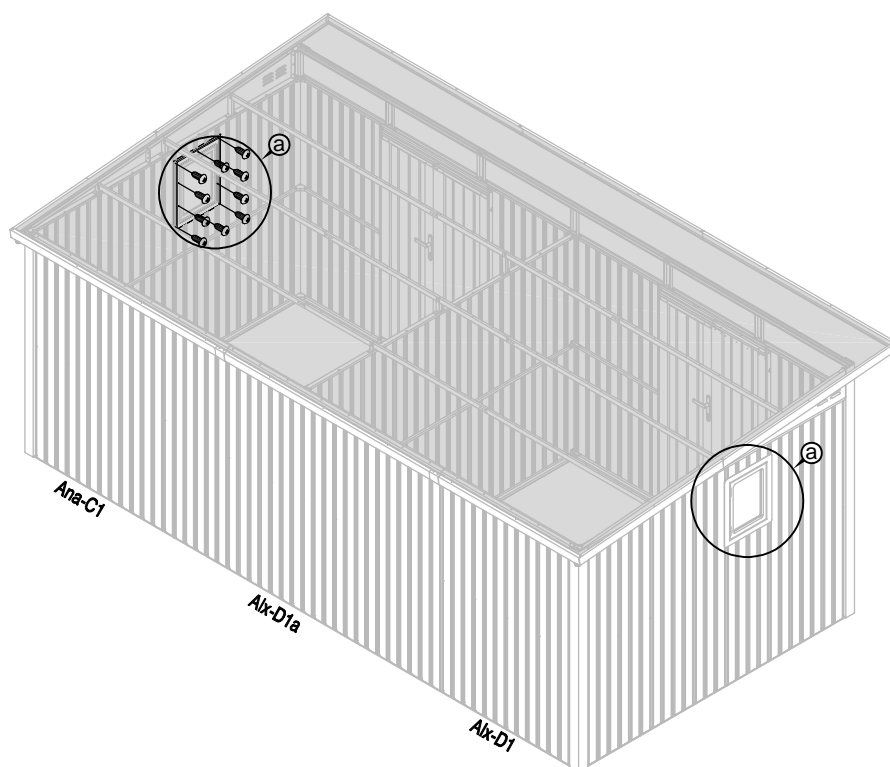
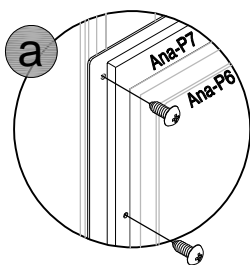

89



Ana-P8 x2



Alx-D50 x4

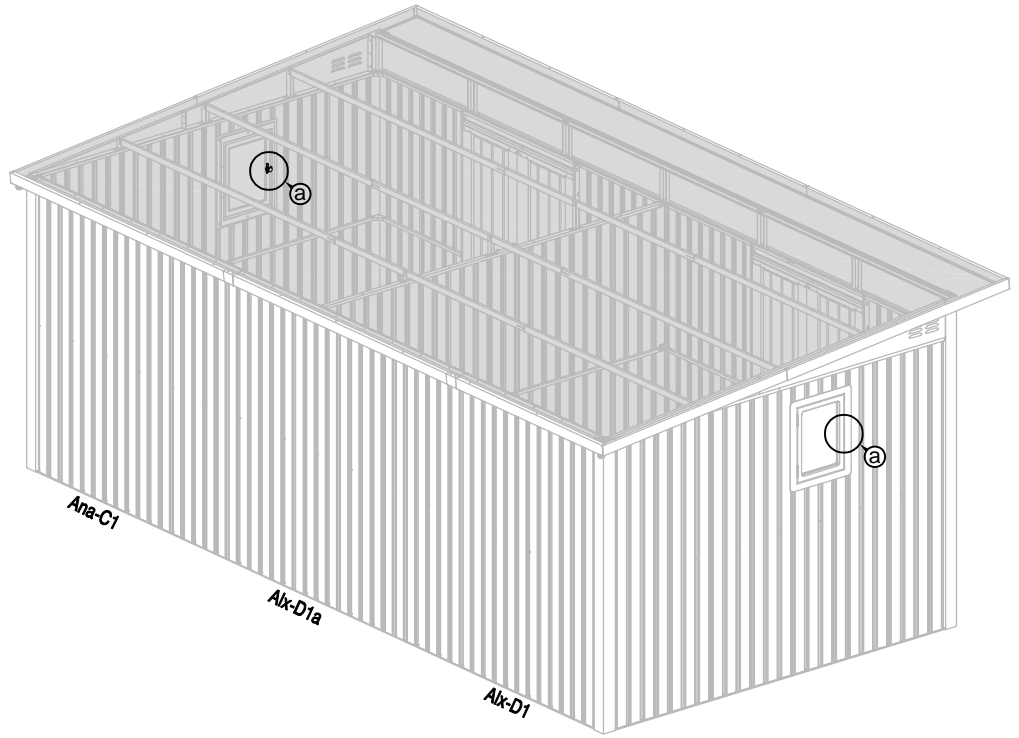
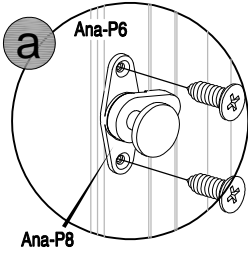

90



Anx-C37 x11m

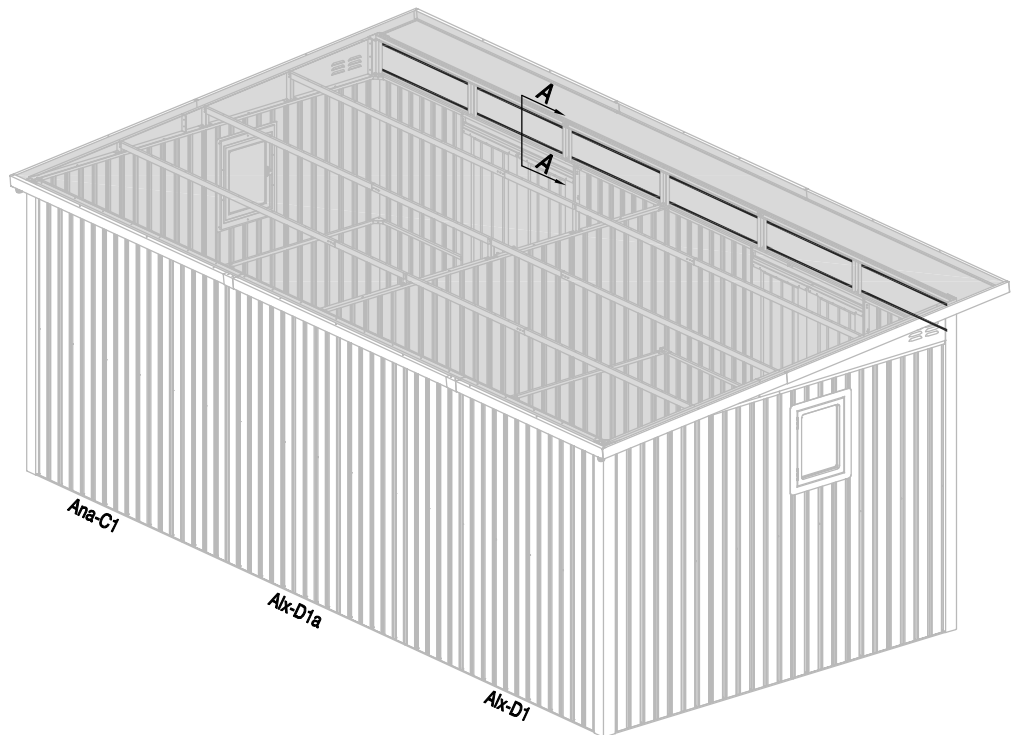
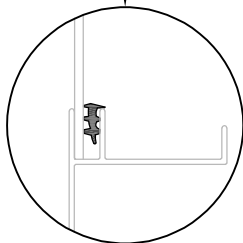
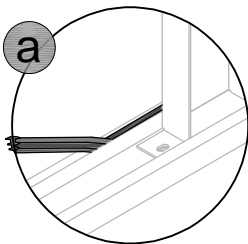

91

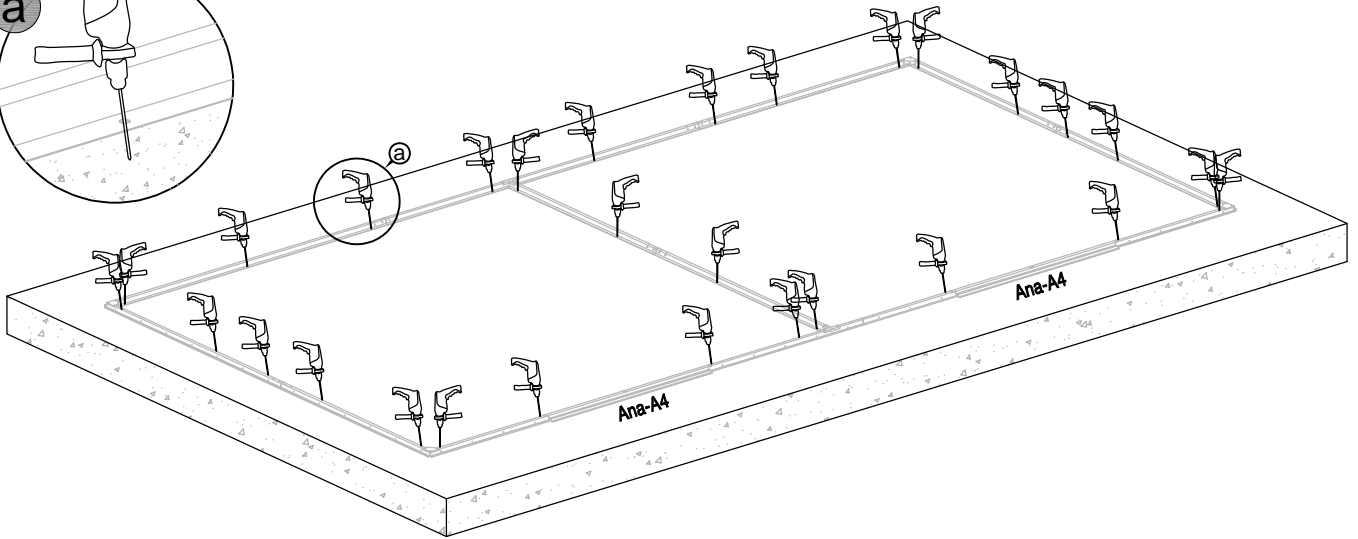
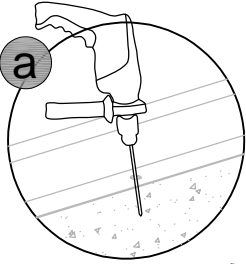
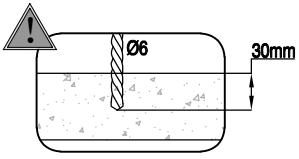
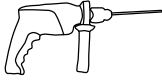

92



Aix-D45 x29

