

# 180 x 90 x 30 cm.

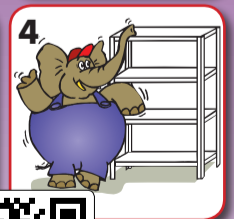

Advantage 5/300

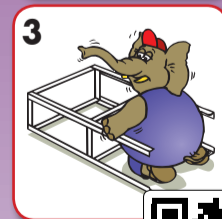
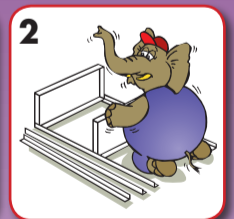
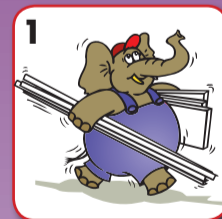
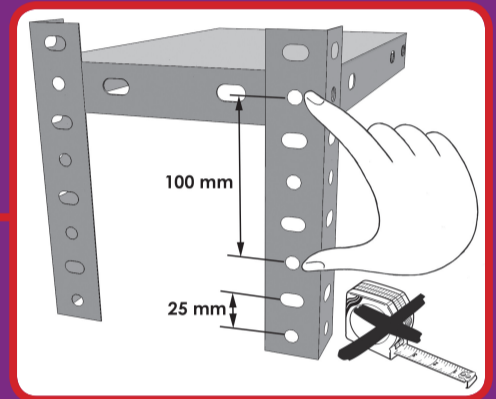
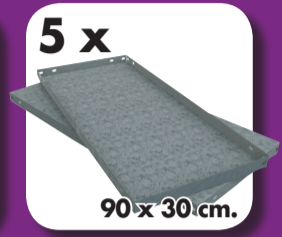
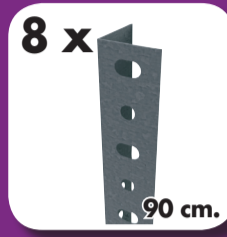

[www.simonrack.com](http://www.simonrack.com)



MADE IN SPAIN

INSTRUCTIONS

