

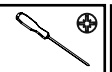

# K126

v.03

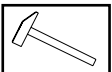
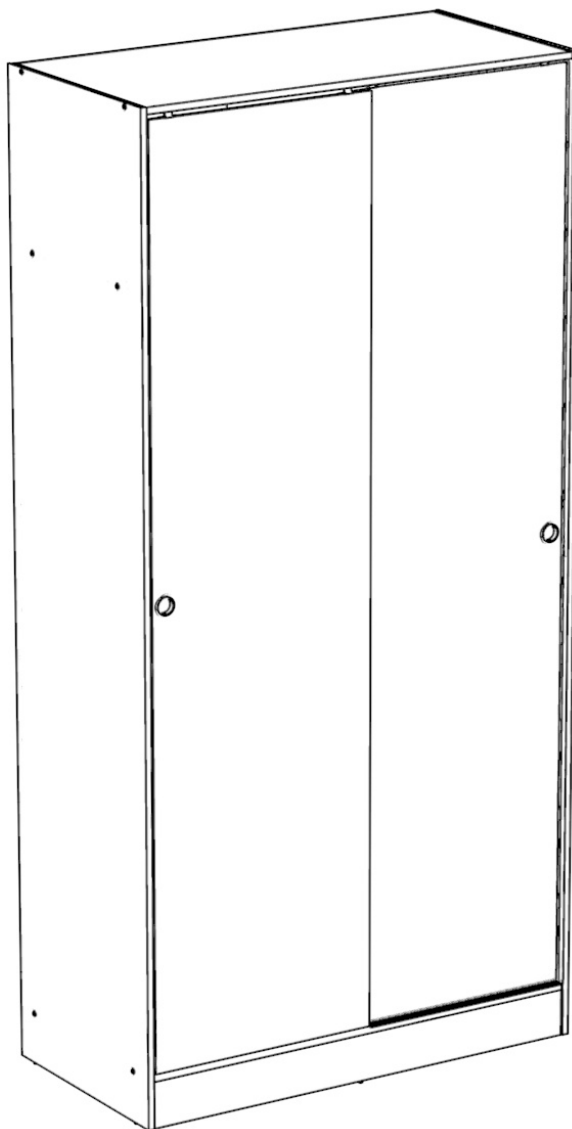

A x 20 	B x 40 	C x 12  5 x 50 mm.	D x 24  3 x 15 mm.	E x 06 	Fx 02 	G x 02 	H x 04 	I x 04 
J x 01 	K x 01  Nº 3	L x 12  3 mm.	M x 02 					



## ES

### RECOMENDACIONES MONTAJE Y USO

Agrupe y cuente el herraje.  
Prepare todas las piezas para el montaje del mueble.  
Tenga preparadas las herramientas para el montaje.  
Prepare la zona del montaje.  
Monte el mueble sobre una moqueta para evitar rayar y dañar la superficie del mueble.  
No fuerce los ensamblajes.  
Evite colocar el mueble cerca de fuentes de calor.  
Evite utilizar trapos, paños o productos de limpieza que puedan dañar la superficie del mueble.  
Mueble para uso doméstico en interior de vivienda.

## EN

### RECOMMENDATIONS FOR ASSEMBLY AND USE

Prepare all the parts of the furniture  
Group and count all the hardware  
Prepare all the tools for the assembly.  
Clear and prepare the assembly area.  
Do the assembly on a carpet to avoid damaging the surface of the furniture  
Avoid forcing the fittings  
Avoid placing the Furniture near any heating source  
Do not use cloths or cleaning products to avoid damaging the surface of the furniture  
Indoor furniture. Suitable for domestic use.

## FR

### CONSEILS DE MONTAGE CONSEILS POUR L'USAGE

Préparez les différents parts du meuble  
Regrouper et compter toute la quincaillerie  
Préparez l'outillage nécessaire  
Aménagez-vous une area de montage  
Faire le montage sur moquette afin de protéger le meuble des rayures  
Ne forcer pas le montage  
Évitez placer le meuble près des sources de chaleur  
Évitez utiliser de chiffons ou des produits de nettoyage pour ne pas rayer la superficie du meuble  
Meuble d'usage domestique pour l'intérieur de la maison.

## PT

### RECOMENDAÇÕES PARA MONTAGEM E USO

Prepare todas as peças para a montagem de móveis  
Reagrupar e contar o hardware  
Preparar as ferramentas de montagem  
Preparar a área de montagem  
Montar as peças em tapete para evitar riscos e danos na superfície dos móveis  
Não force as assembleias  
Não colocar móveis perto de fontes de calor  
Evitar o uso de panos, trapos ou produtos de limpeza que possam riscar o móvel.  
Móveis para uso doméstico no interior da casa.

## IT

### CONSIGLI INSTALLAZIONE ED USO

Preparare tutti componenti del mobile per il montaggio  
Ordinare la ferramenta  
Preparare tutti gli attrezzi necessari per il montaggio  
Preparare l'area di montaggio  
Fare il montaggio su un tappeto per evitare danneggiare le superfici dei mobili  
Non forzare i componenti  
Evitare posizionare il mobile in prossimità di fonti di calore  
Non usare panni né detersivi né solventi che possano danneggiare le superficie dei mobili  
Mobili per uso domestico all'interno della casa.

## DE

### MONTAGEHINWEISE-GEBRUCHSHINWEISE

Identifizieren Sie die Einzelteile  
Überprüfen Sie Die Anzahl der einzelnen Beschlagteile  
Legen Sie das notwendige Werkzeug bereit  
Bereiten die Montagefläche  
Montieren Sie das Möbel auf einem Teppich, säubern Untergrund  
Niemaals die verbindungen zu start anziehen  
Nicht neben Wärmequellen platzieren  
Vermeiden Sie Tücher und keinesfalls scharfe oder ätzende Reinigungsmittel.  
Möbel für den Gebrauch im Haus geeignet.

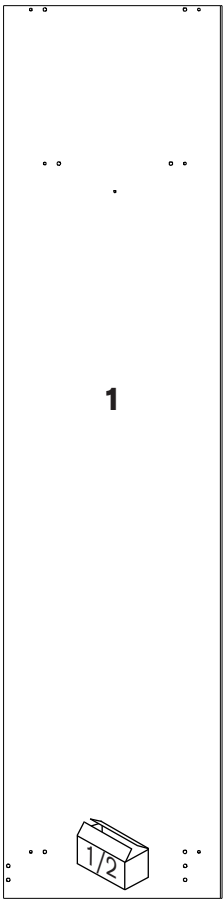

499 x 2040 mm.

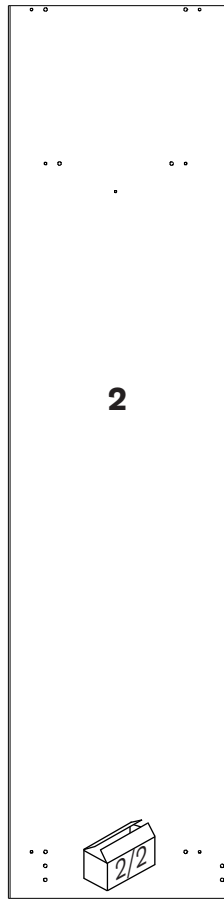

499 x 2040 mm.

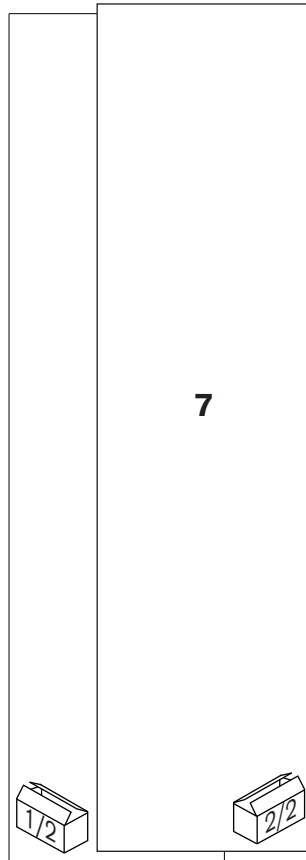

492 x 1940 mm.

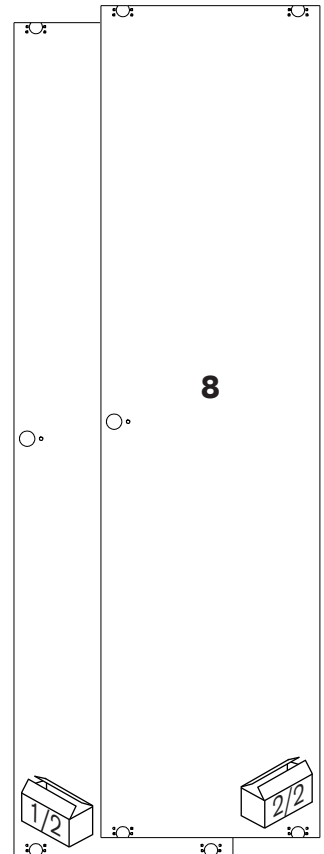

500 x 1901 mm.

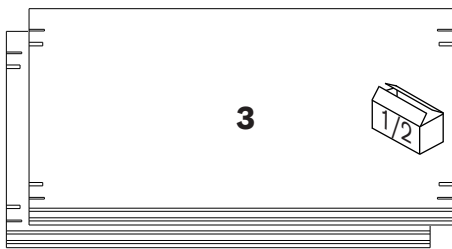

968 x 494 mm.

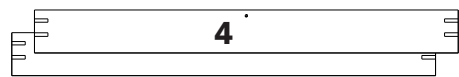



968 x 98 mm.

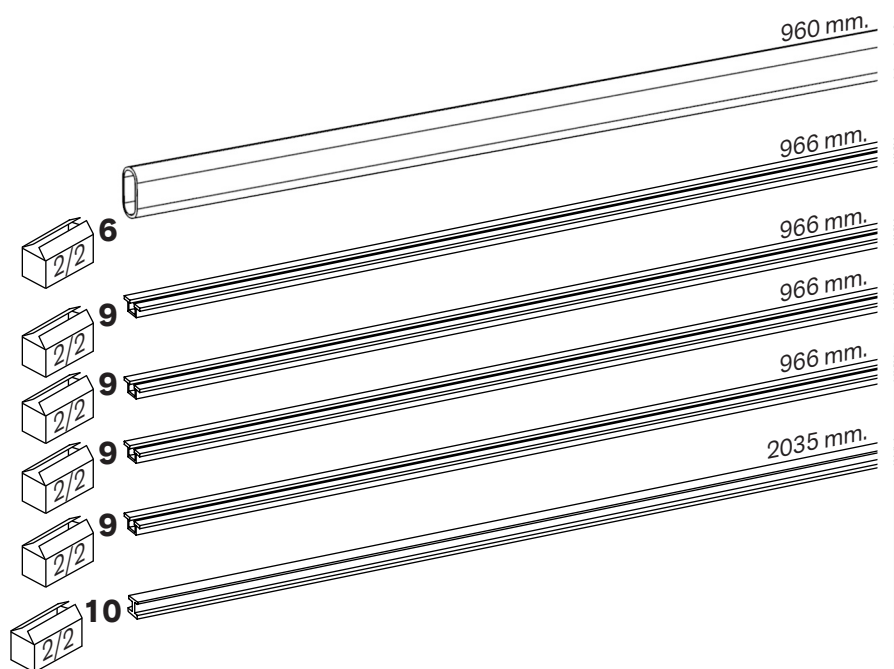

968 x 431 mm.

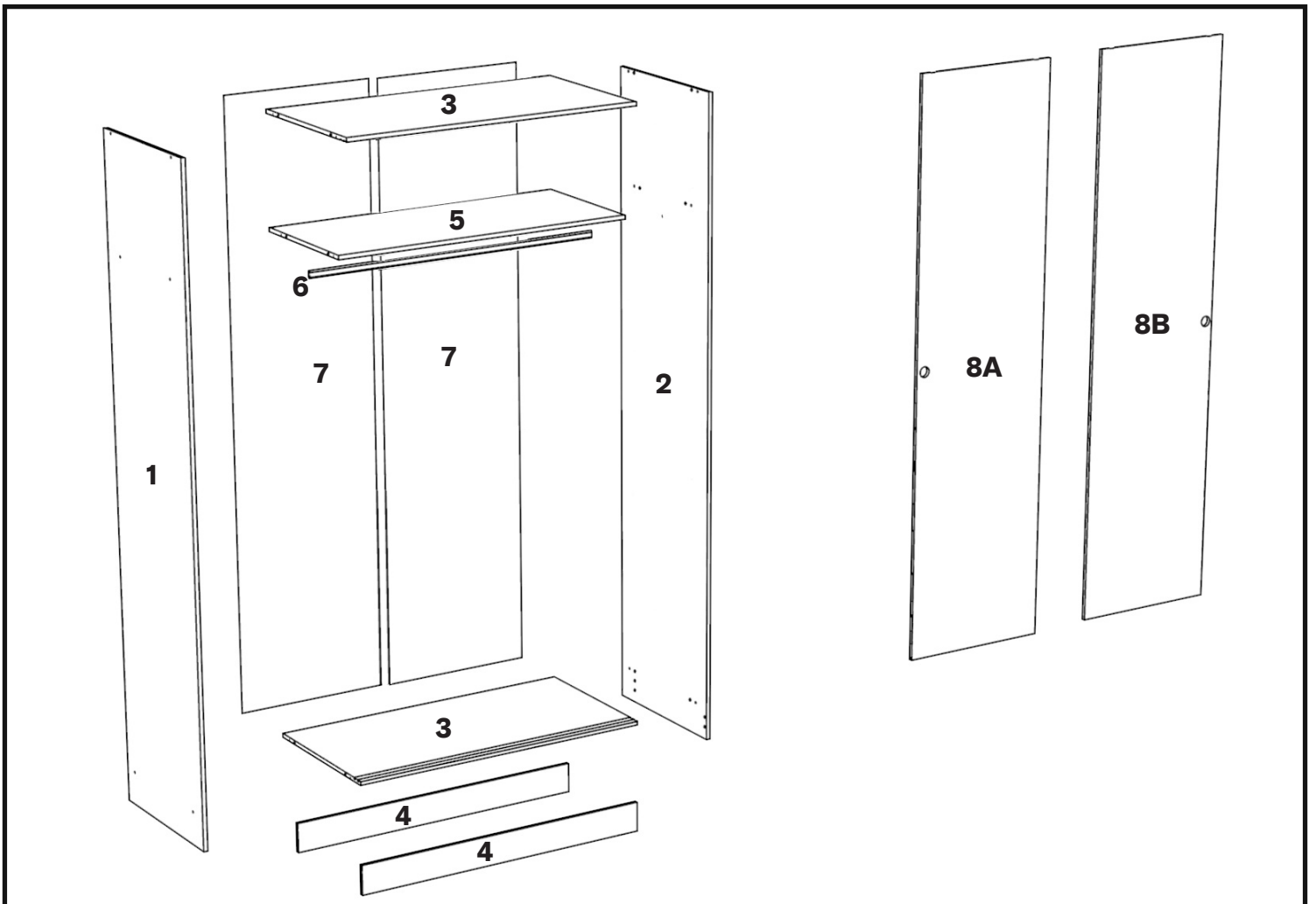

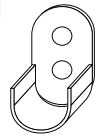

1	<b>D x 02</b>  3 x 15 mm.	<b>E x 02</b> 	<b>F x 01</b> 
---	--------------------------------------------------------------------------------------------------------------------	------------------------------------------------------------------------------------------------------	------------------------------------------------------------------------------------------------------

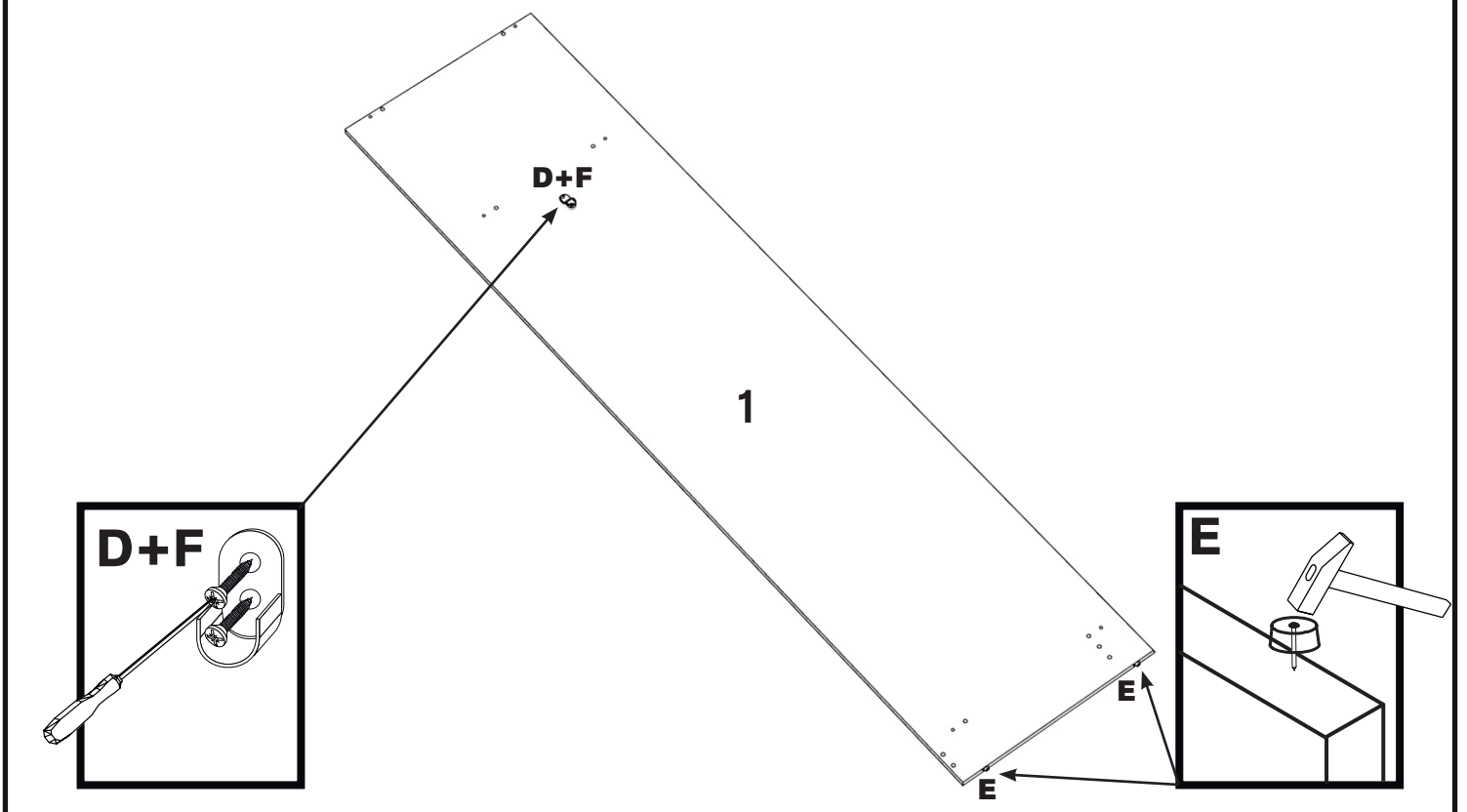

2

D x 02

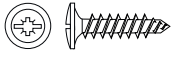

3 x 15 mm.

E x 02

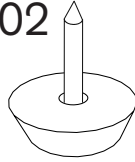

F x 01

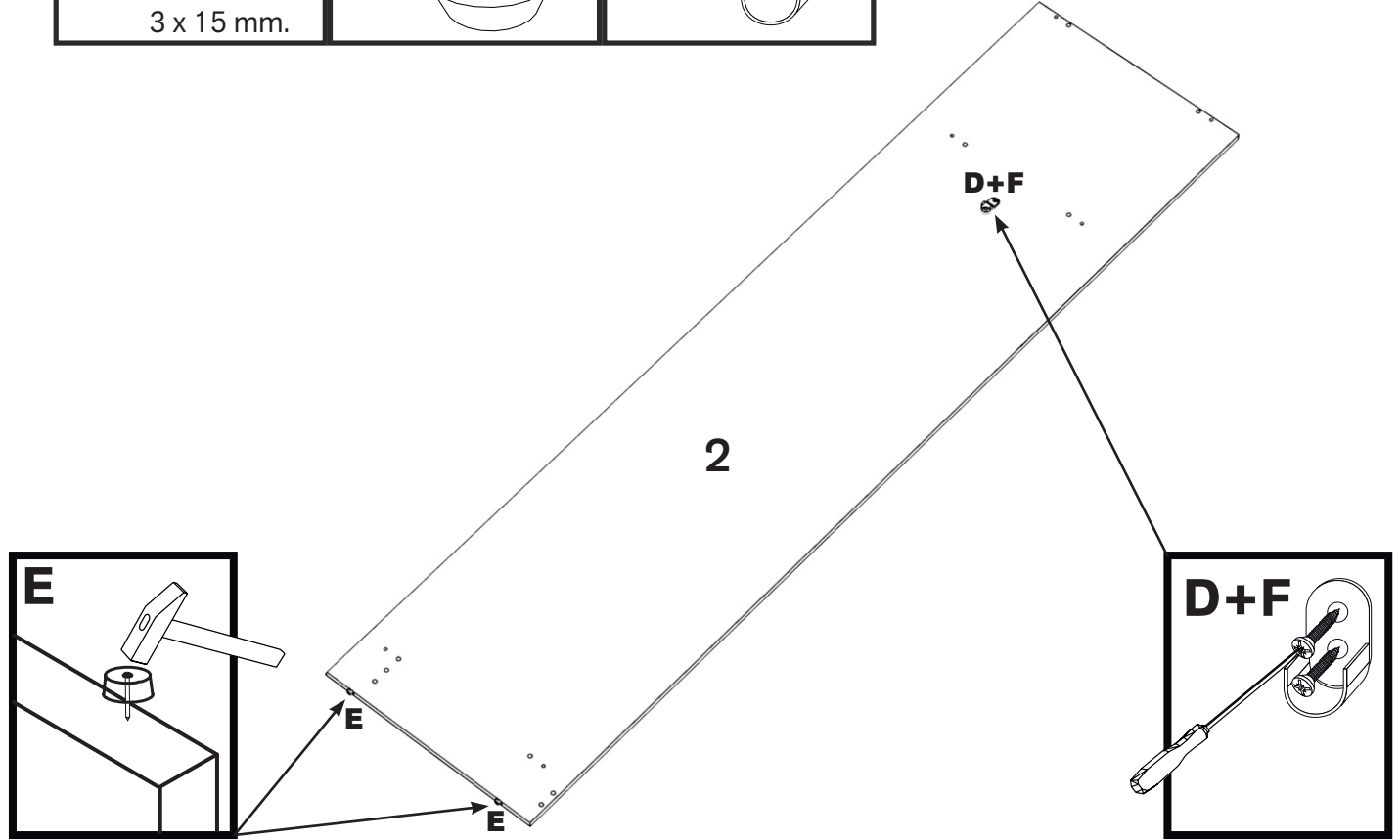
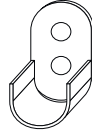

3

A x 08

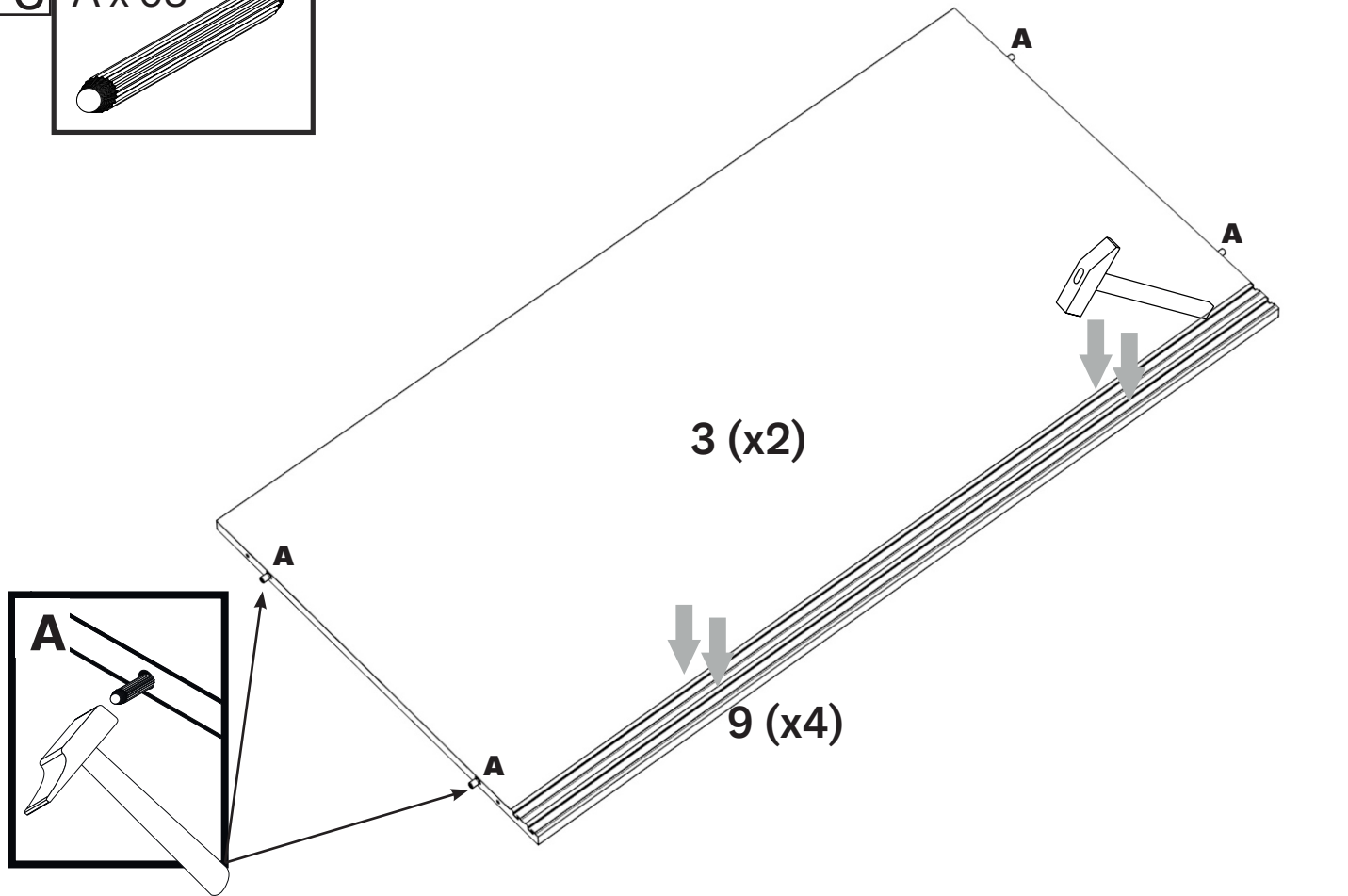
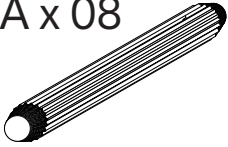

4 A x 04

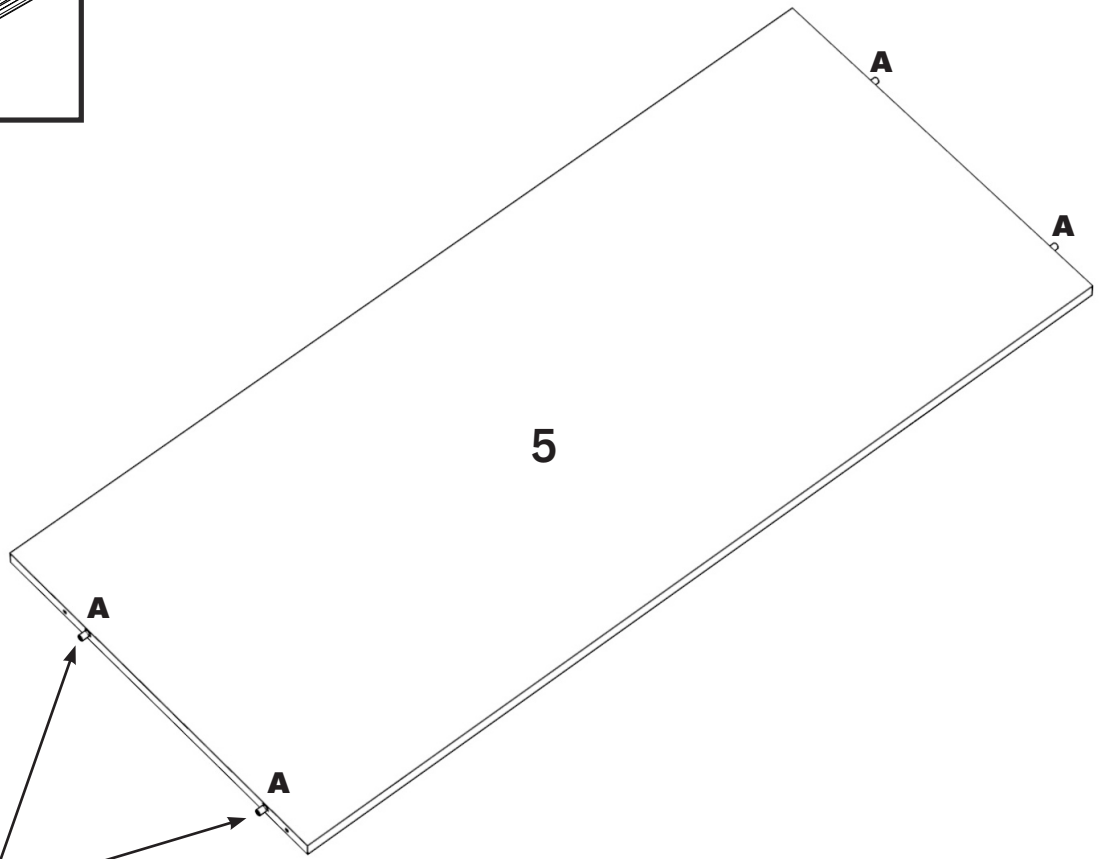
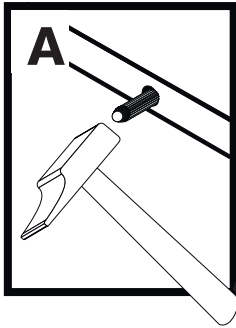
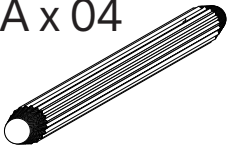

5 A x 08

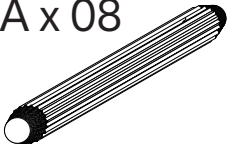

D x 02



3 x 15 mm.

E x 02



F x 02

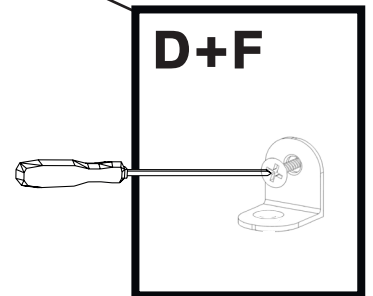
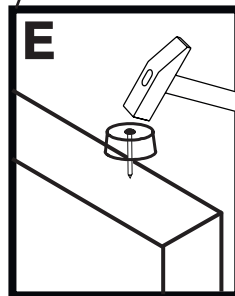
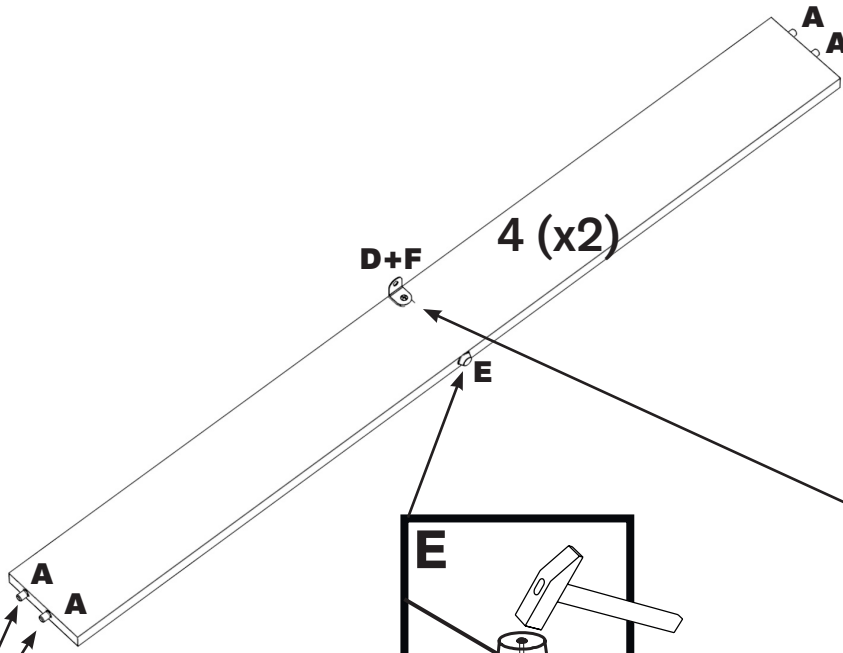
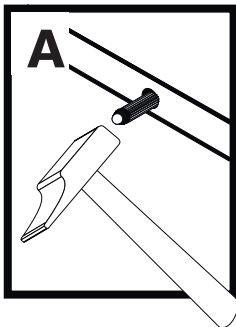

6

D x 08

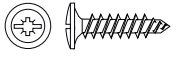

3 x 15 mm.

H x 02



I x 02

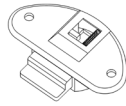

J x 01

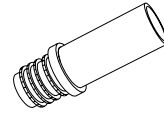

M x 01

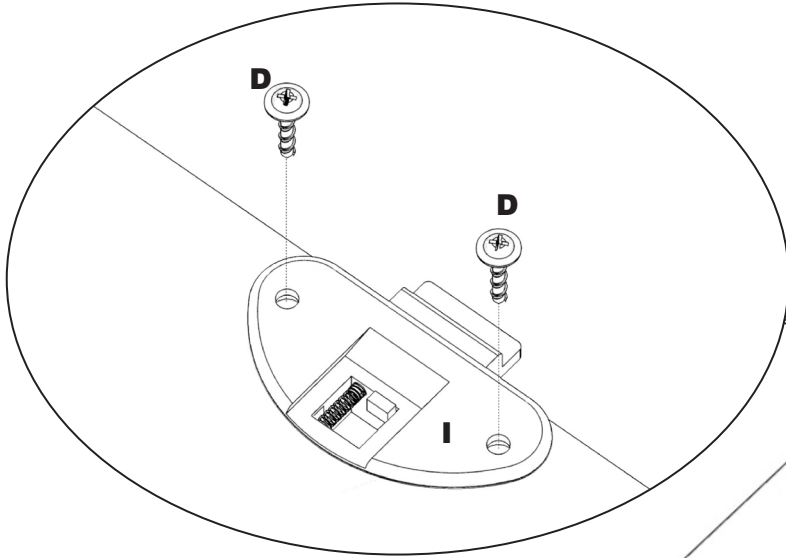
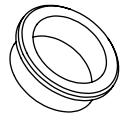

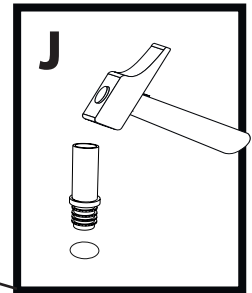

**Puerta Exterior**  
**Outer Door**  
**Porta Exterior**  
**Porte Extérieur**

8A

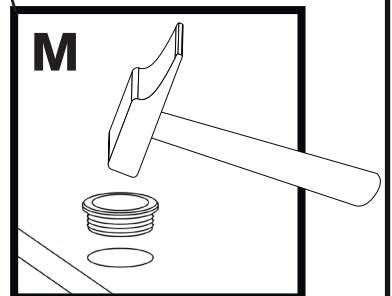
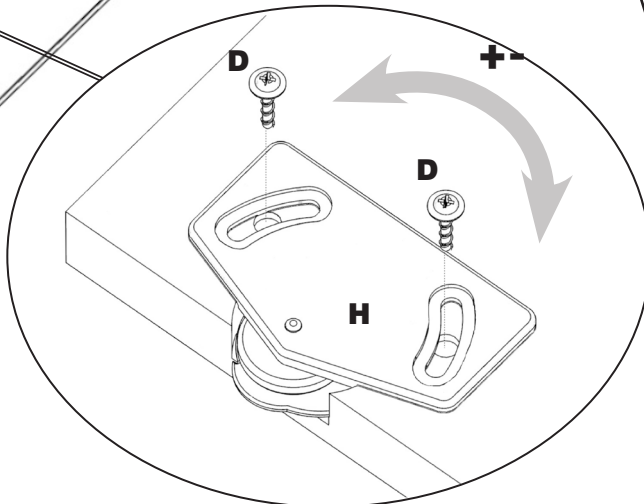

D+H



7

D x 08



3 x 15 mm.

H x 02



I x 02

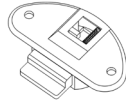

M x 01

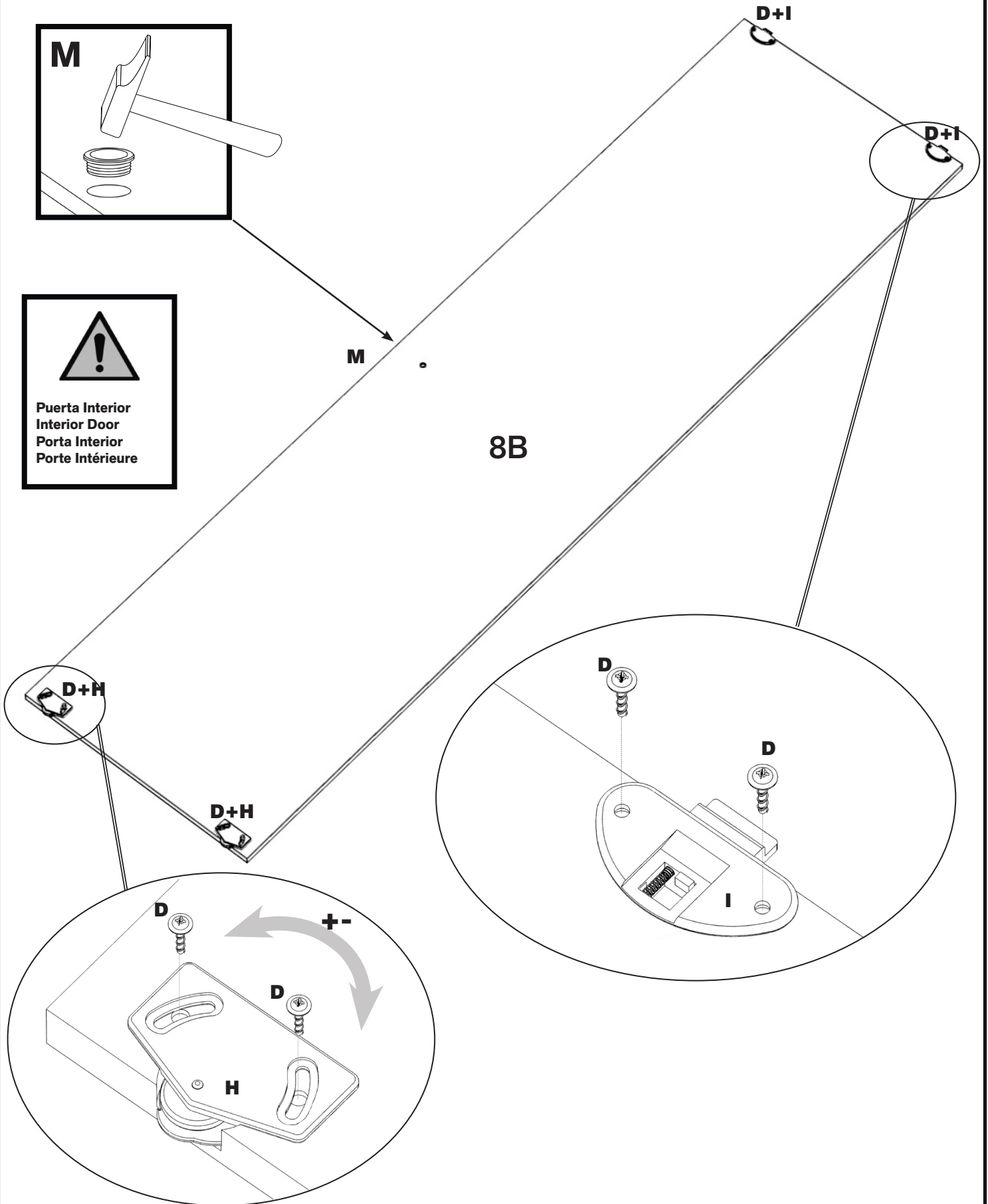
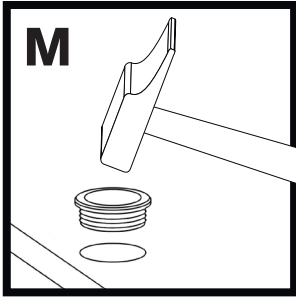
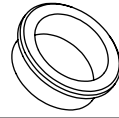

8

C x 12



5 x 50 mm.

K x 01

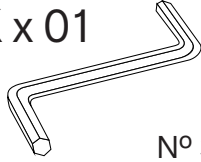

Nº 3

L x 12



3 mm.

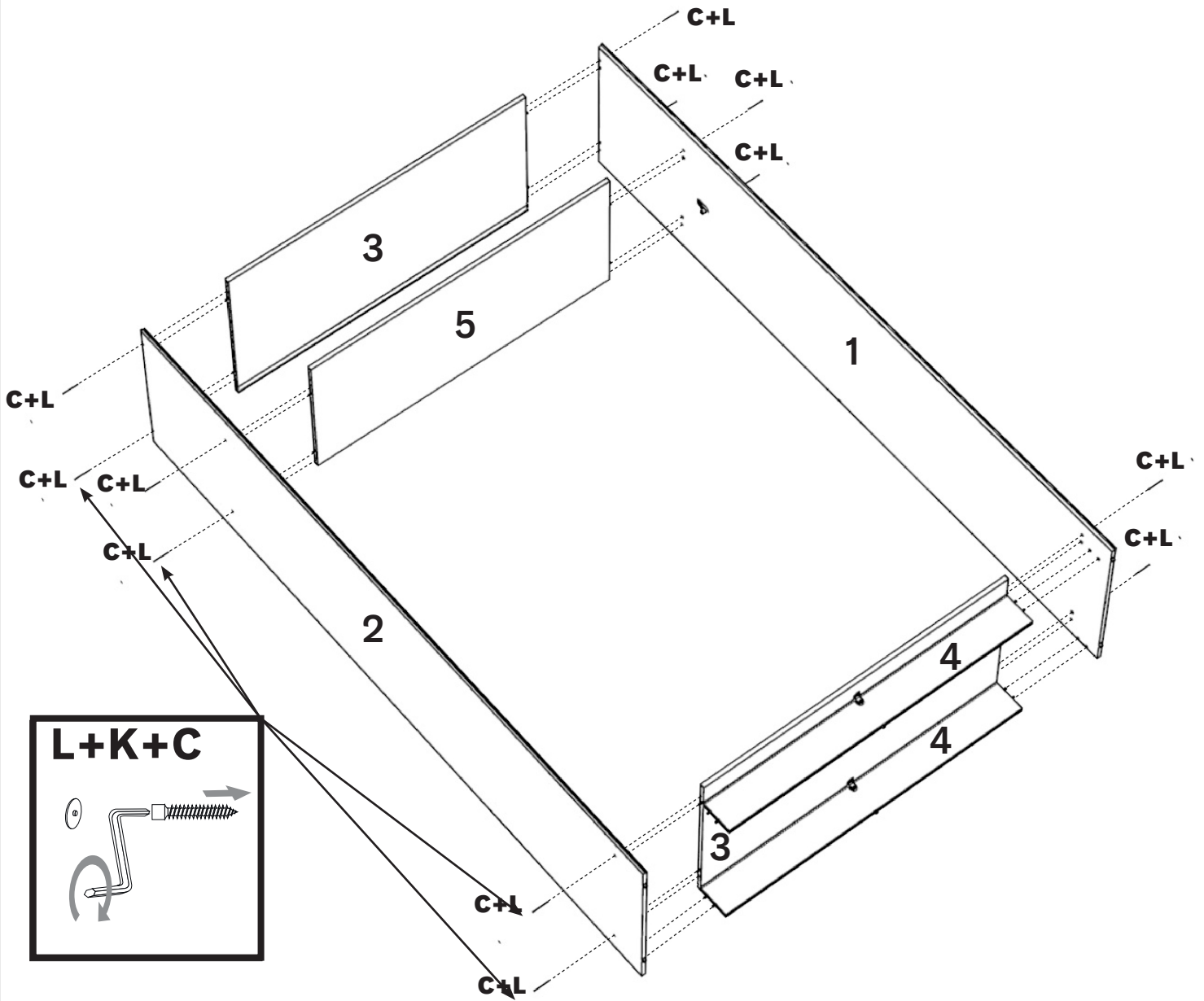

9

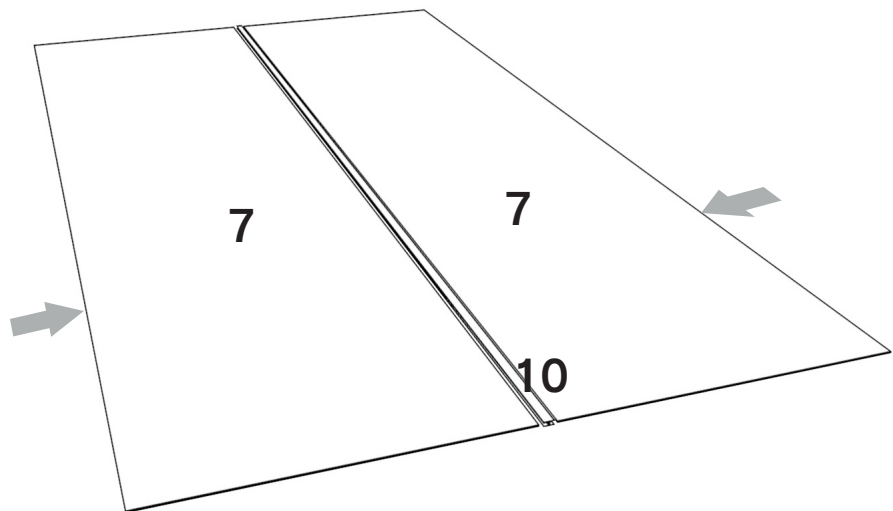



10

B x 40

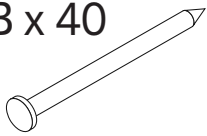

D x 02



3 x 15 mm.

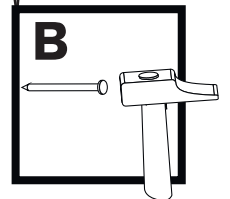
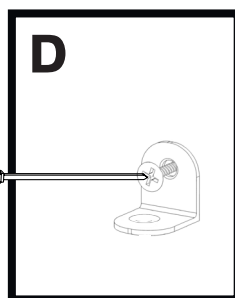
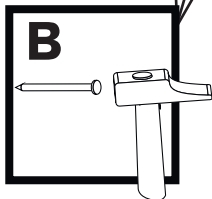
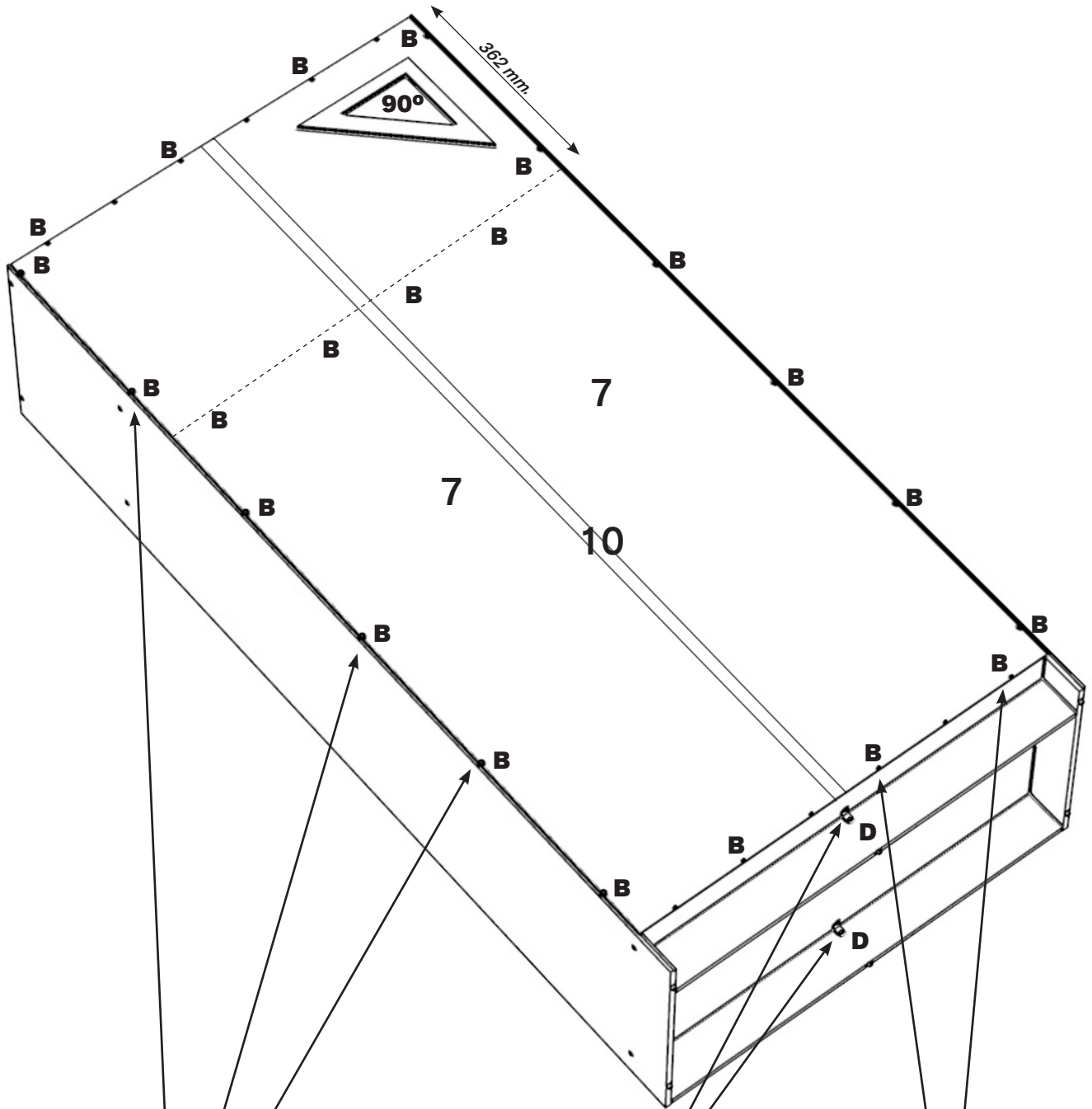

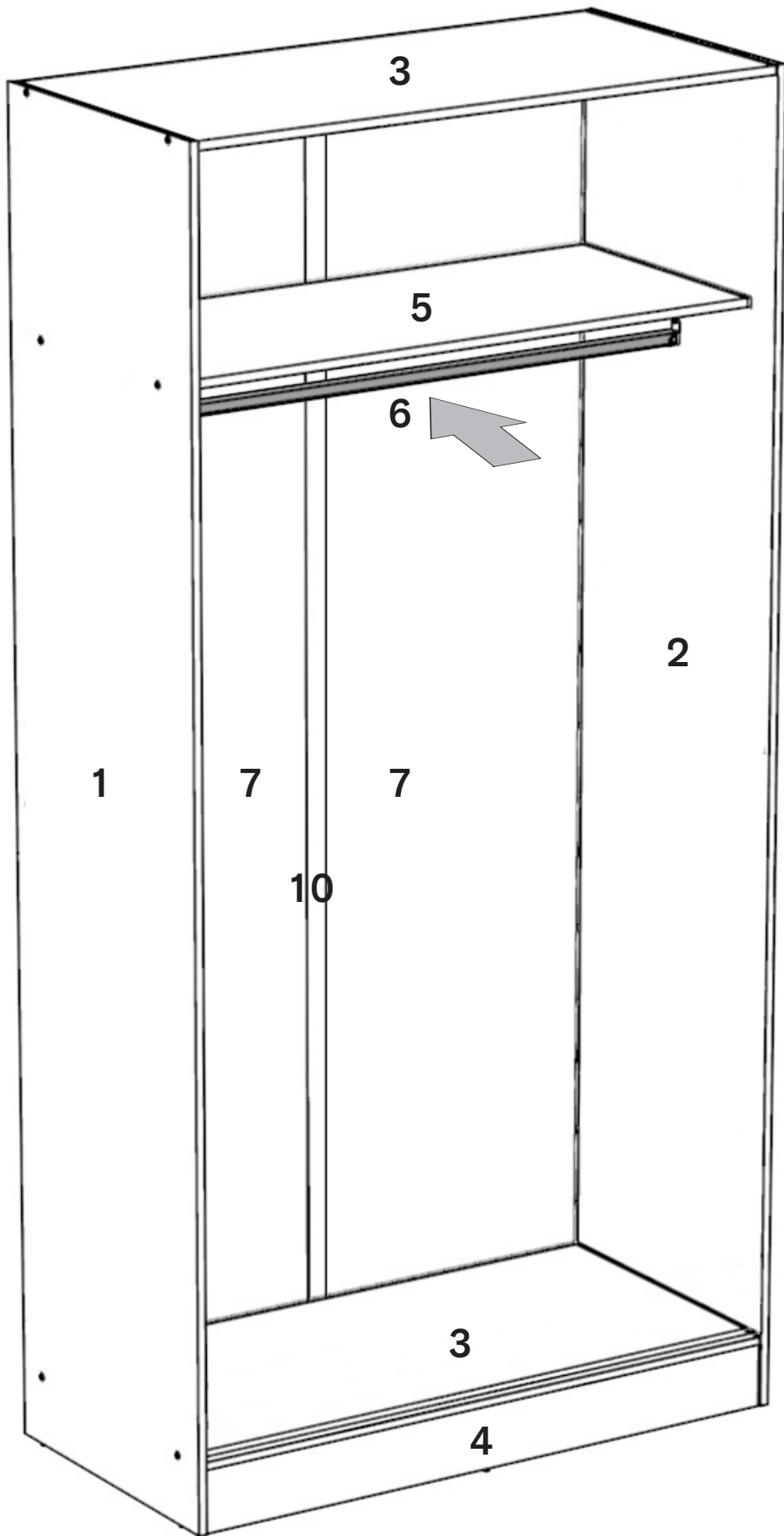

12

