

70340

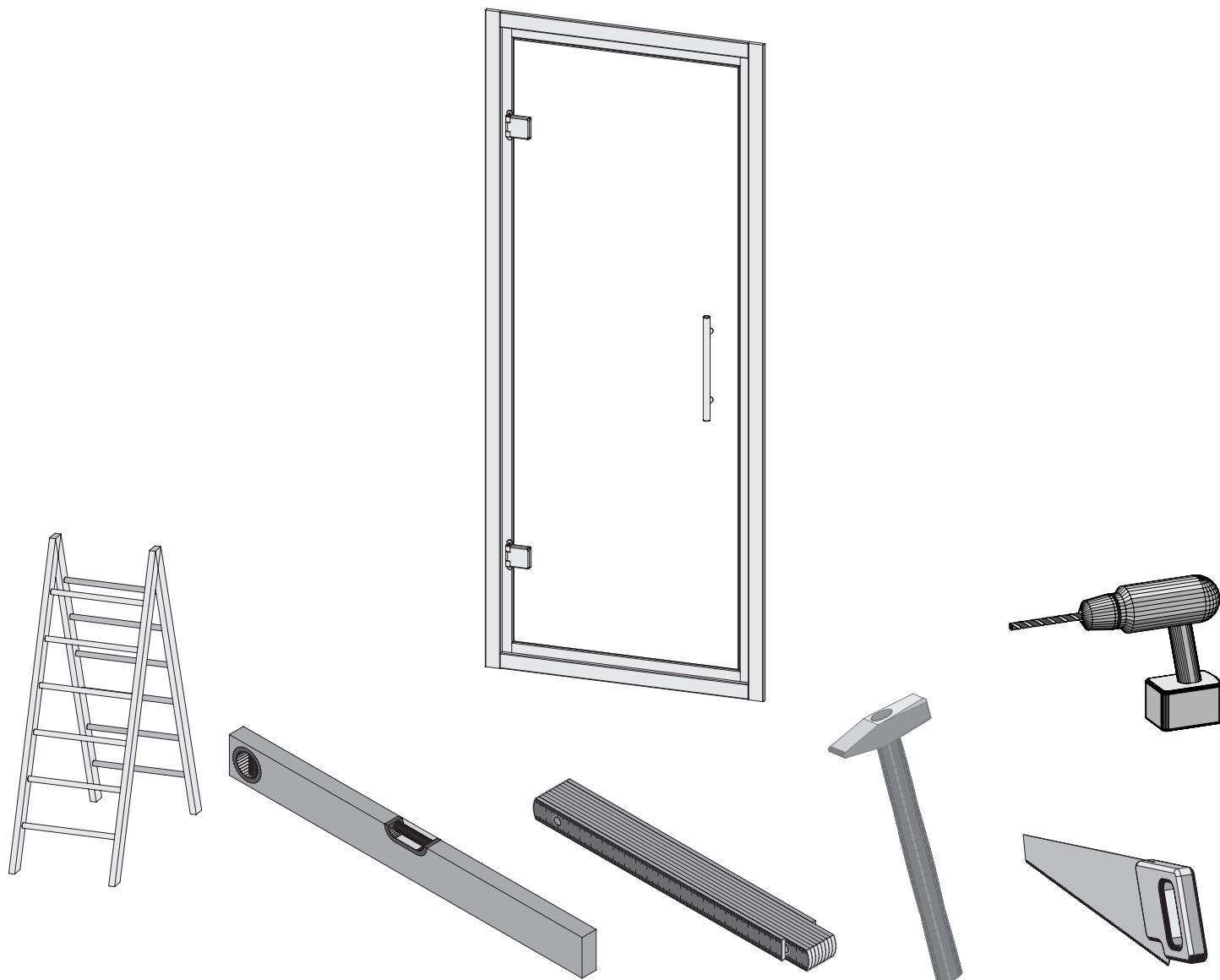

 **Aufbauanleitung**

 **notice de montage**

 **Building Instructions**

 **montagehandleiding**

 **Instrucciones de construcción**

 **Istruzioni per il montaggio**

 **Service-Hotline: +49 421 38693 33**



Vergleichen Sie zuerst die Materialliste mit Ihrem Paketinhalt! Bitte haben Sie Verständnis, dass Beanstandungen nur im nicht aufgebauten Zustand bearbeitet werden können!



Commencez par comparer la liste du matériel avec le contenu de votre paquet! Sachez que nous traitons uniquement les réclamations concernant le matériel à l'état non monté!



First compare the list of materials with your package contents! Please understand that complaints can be processed in the non-built status only!



Vergelijk eerst de lijst van materialen met de inhoud van uw pakket! Reclamaties kunnen alleen in behandeling worden genomen zolang de onderdelen nog niet zijn gemonteerd!



En primer lugar, compare la lista de material con el contenido del paquete. Rogamos entienda que las reclamaciones sólo pueden ser tramitadas antes de montar el objeto!



Confrontate questa distinta materiali prima con il contenuto del pacchetto! Vi preghiamo di comprendere che eventuali reclami possono essere accolti solo prima del montaggio!



70340

1 x		ID 70352
1 x		ID 70348
1 x		ID 70349

 Einbau Saunatür

 Sauna deur installatie

 Sauna Instalace dveře

 Installation de porte Sauna

 Instalación de la puerta Sauna

 Sauna door installation

 Installazione porta Sauna

01

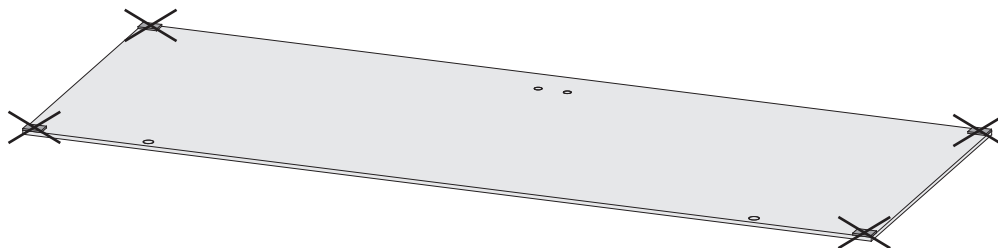

02

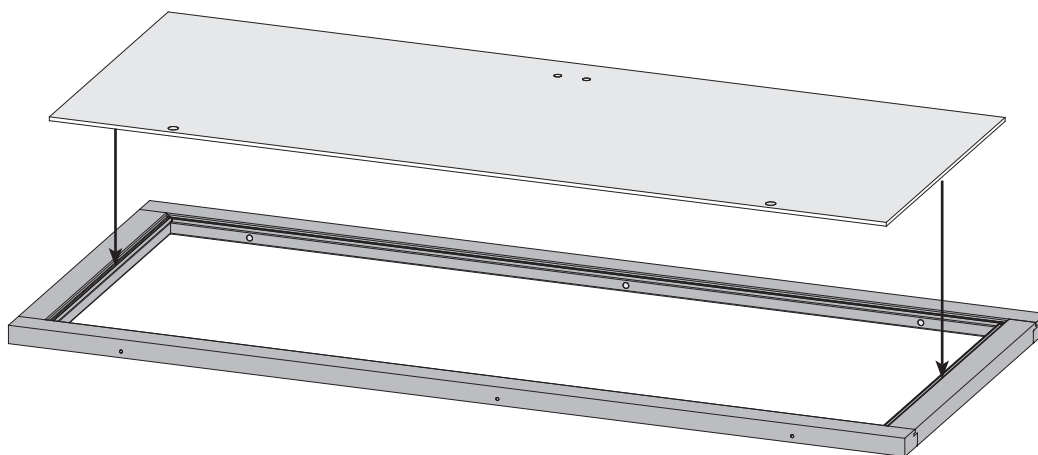

03

 Das Saunätürglas im Türrahmen ausrichten!

 Bien aligner le verre à vitre!

 To start building up the door you need to center the glass in the wooden frame!

 Plaats het glas van de sauna deur in het midden van het kozijn!

 ¡Centrar la puerta de cristal dentro del marco!

 Allineare il vetro dello sportello sauna al telaio della porta!

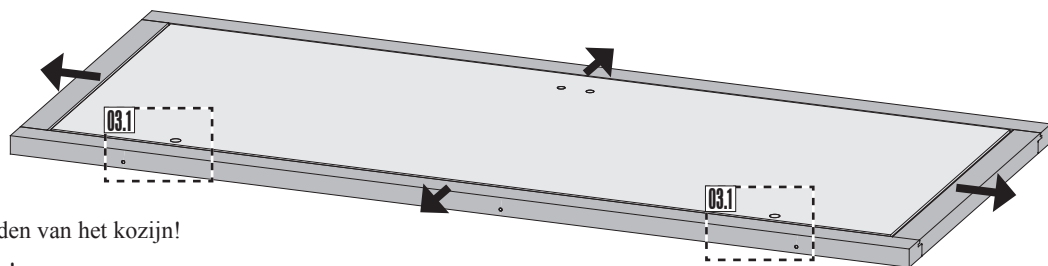

03.1-1

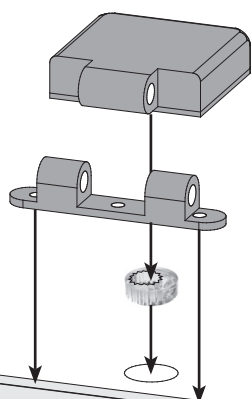

03.1-2

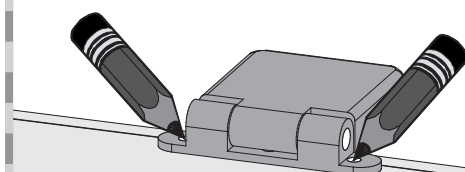

03.1-3

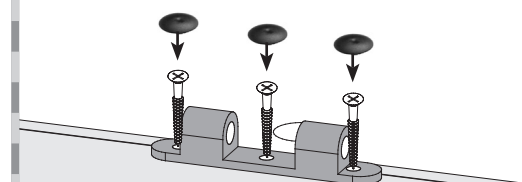

 Einbau Saunatür

 Sauna deur installatie

 Sauna Instalace dveře

 Installation de porte Sauna

 Instalación de la puerta Sauna

 Sauna door installation

 Installazione porta Sauna

04

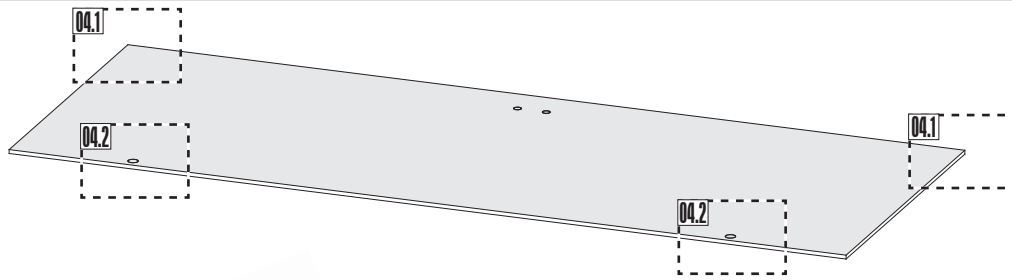

04.1-1

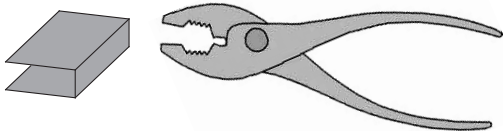

04.1-2

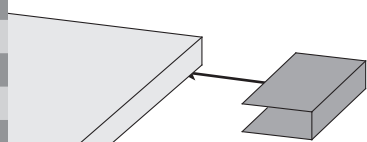

04.1-3

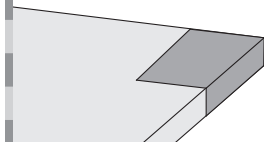

04.2-1

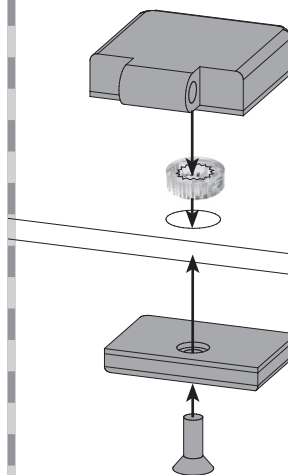

04.2-2

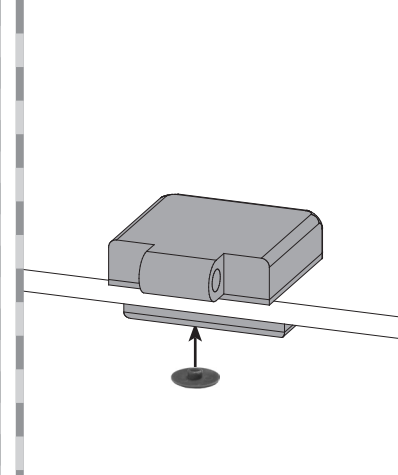

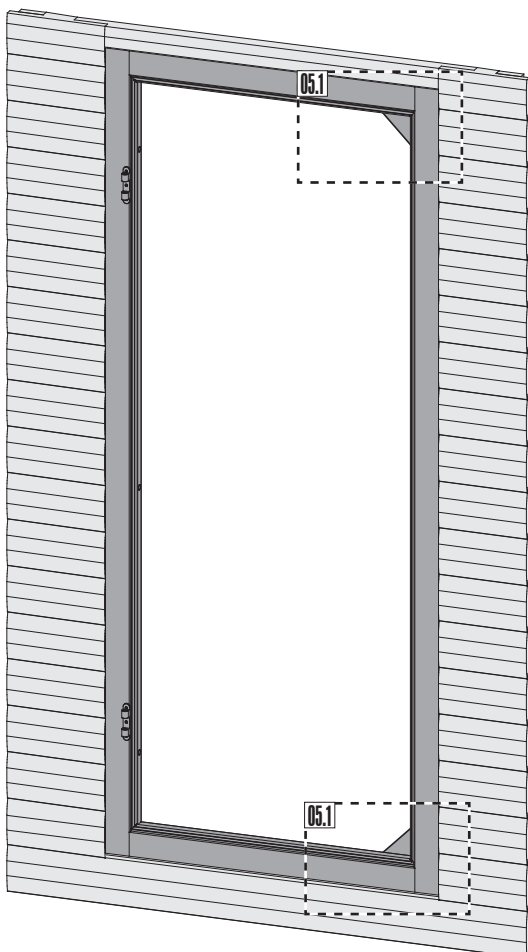

05





 Achtung: Alle Verstell-Excenter müssen in der Glasscheibe die gleiche Grundstellung haben!

 Attention: Tous les excentres de positionnement doivent avoir la même position de base dans la vitre!

 Attention: All adjustable eccentrics must have the same basic adjustment in the glass panel!

 Attentie: alle excentrische verstelelementen moeten in dezelfde stand in de glasplaat worden geplaatst!

 Atención: Todos los excéntricos regulables tienen que tener la misma posición base en la hoja de cristal.

 Attenzione: Tutti gli eccentrici di regolazione devono avere la stessa posizione base nella lastra di vetro!

05.1-1



05.1-2



 Einbau Saunatür

 Sauna deur installatie

 Sauna Instalace dveře

 Installation de porte Sauna

 Instalación de la puerta Sauna

 Sauna door installation

 Installazione porta Sauna

06

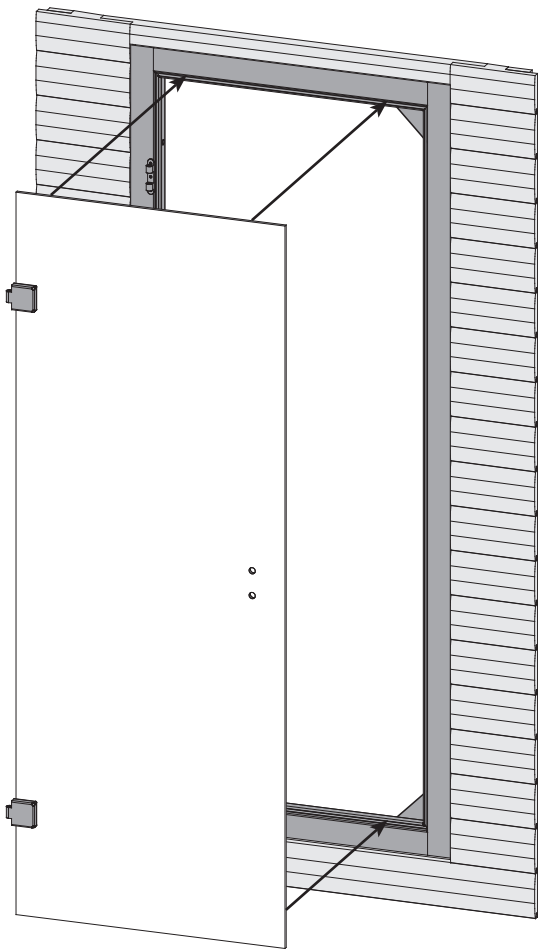

07

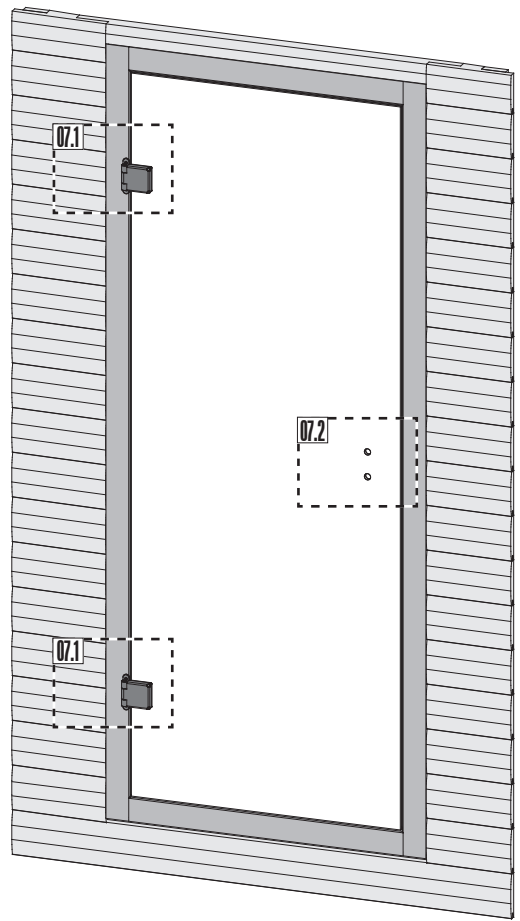

07.1

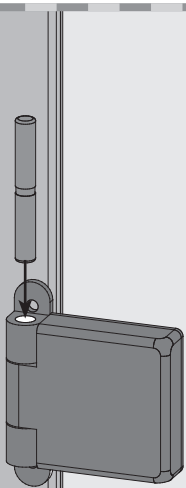

07.2

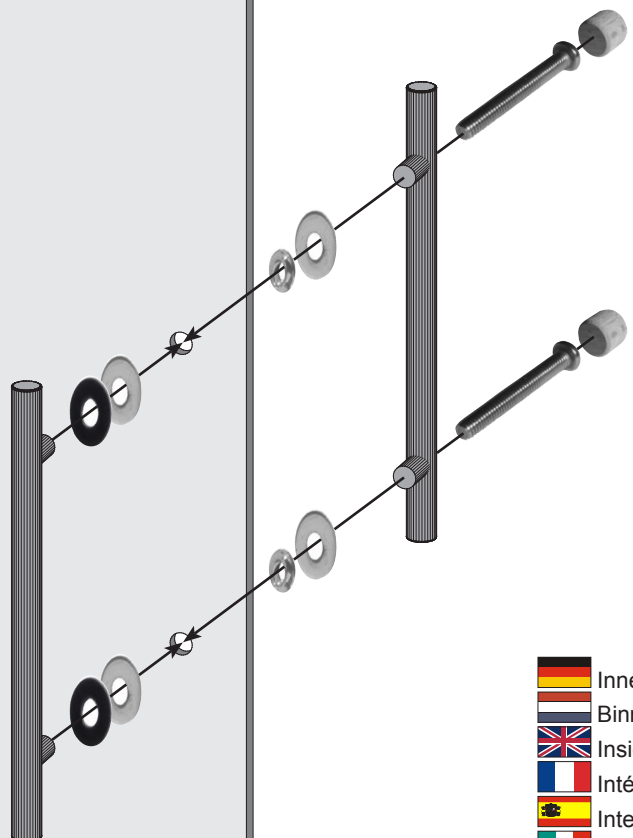

-  Außen: Metall
-  Buiten: metaal
-  Outside: metal
-  Extérieur: métal
-  Exterior: metal
-  Esterno: metallo
-  Venku: kov

-  Innen: Holz
-  Binnen: wood
-  Inside: wood
-  Intérieur: bois
-  Interior: madera
-  Interno: legno
-  Uvnitř: dřev

 **Seitenverstellung + Höhenverstellung**

Achtung: Alle Verstell-Excenter müssen in der Glasscheibe die gleiche Grundstellung haben!

 **Positionnement latéral + positionnement hauteur**

Attention: Tous les excentriques de positionnement doivent avoir la même position de base dans la vitre!

 **Lateral adjustment + height adjustment**

Attention: All adjustable eccentrics must have the same basic adjustment in the glass panel!

 **Zijverstelling + hoogteverstelling**

Attentie: alle excentrische verstelelementen moeten in dezelfde stand in de glasplaat worden geplaatst!

 **Regulación lateral + regulación de la altura**

Atención: Todos los excéntricos regulables tienen que tener la misma posición base en la hoja de cristal.

 **Regolazione laterale + regolazione dell'altezza**

Attenzione: Tutti gli eccentrici di regolazione devono avere la stessa posizione base nella lastra di vetro!

