



ETA-Danmark A/S  
 Göteborg Plads 1  
 DK-2150 Nordhavn  
 Tel. +45 72 24 59 00  
 Fax +45 72 24 59 04  
 Internet [www.etadanmark.dk](http://www.etadanmark.dk)

Authorised and notified according  
 to Article 29 of the Regulation (EU)  
 No 305/2011 of the European  
 Parliament and of the Council of 9  
 March 2011

MEMBER OF EOTA



## European Technical Assessment ETA-06/00106 of 14/10/2014

I General Part

**Technical Assessment Body issuing the ETA and designated according to Article 29 of the Regulation (EU) No 305/2011: ETA-Danmark A/S**

**Trade name of the construction product:**

Simpson Strong-Tie Angle Brackets  
 See type numbers in section II.1 of the ETA

**Product family to which the above construction product belongs:**

Three-dimensional nailing plate (timber-to-timber/timber-to-concrete angle bracket)

**Manufacturer:**

SIMPSON STRONG-TIE A/S  
 Hedegaardsvej 4 – 11, Boulstrup  
 DK-8300 Odder  
 Tel. +45 87 81 74 00  
 Fax +45 87 81 74 09  
 Internet [www.simpsonstrongtie.dk](http://www.simpsonstrongtie.dk)

**Manufacturing plant:**

Simpson Strong-Tie A/S Hedegaardsvej 4-11, Boulstrup 8300 Odder Denmark	Simpson Strong-Tie ZAC des Quatre Chemins 85400 Sainte Gemme La Plaine France	Simpson Strong-Tie Winchester Road Cardinal Point Tamworth Staffordshire B78 3HG United Kingdom	Simpson Strong-Tie 5151 S. Airport Way Stockton CA 95206 USA	Simpson Strong-Tie 2600 International Street Columbus, (C) 43228 USA
-------------------------------------------------------------------------------------	-------------------------------------------------------------------------------------------------------	-------------------------------------------------------------------------------------------------------------------------	--------------------------------------------------------------------------------	----------------------------------------------------------------------------------------

**This European Technical Assessment contains:**

291 pages including 4 annexes which form an integral part of the document

**This European Technical Assessment is issued in accordance with Regulation (EU) No 305/2011, on the basis of:**

Guideline for European Technical Approval (ETAG) No. 015 Three Dimensional Nailing Plates, April 2013, used as European Assessment Document (EAD).

**This version replaces:**

The ETA with the same number issued on 2014-08-25

<b>II SPECIAL CONDITIONS OF THE EUROPEAN TECHNICAL ASSESSMENT .....</b>	<b>5</b>
1 TECHNICAL DESCRIPTION OF PRODUCT AND INTENDED USE .....	5
2 SPECIFICATION OF THE INTENDED USE IN ACCORDANCE WITH THE APPLICABLE EAD .....	5
3 CHARACTERISTICS OF PRODUCT AND ASSESSMENT.....	7
4 ASSESSMENT AND VERIFICATION OF CONSTANCY OF PERFORMANCE (AVCP).....	10
5 TECHNICAL DETAILS NECESSARY FOR THE IMPLEMENTATION OF THE AVCP SYSTEM, AS FORESEEN IN THE APPLICABLE EAD.....	10
<b>ANNEX A - REVISION HISTORY.....</b>	<b>11</b>
<b>ANNEX B - TYPICAL INSTALLATION.....</b>	<b>14</b>
<b>ANNEX C - BASIS OF DESIGN.....</b>	<b>15</b>
ANNEX C1 – BASIS OF DESIGN .....	15
ANNEX C2 – DEFINITION OF FORCES DIRECTION .....	16
ANNEX C3 – FASTENERS SPECIFICATION AND CAPACITIES .....	20
ANNEX C4 – CHARACTERISTIC CAPACITY MODIFICATION METHODS FOR NAILS AND TIMBER TYPES.....	21
<b>ANNEX D - PRODUCT DEFINITION AND CAPACITIES.....</b>	<b>22</b>
ANNEX D1 – ABR90 .....	22
ANNEX D2 – AB90.....	32
ANNEX D3 – ABR105 .....	39
ANNEX D4 – AB105.....	49
ANNEX D5 – ABR70 .....	56
ANNEX D6 – AB70.....	63
ANNEX D7 – E20/3.....	65
ANNEX D8 – E9/2.5.....	74
ANNEX D9 – E9S/2.5 .....	80
ANNEX D10 – ABR9015 .....	86
ANNEX D11 – ABR9020 .....	91
ANNEX D12 – ABR100 .....	98
ANNEX D13 – AA60280 .....	104
ANNEX D14 – ABB40390 .....	107
ANNEX D15 – AE48.....	111
ANNEX D16 – AE76.....	116
ANNEX D17 – AE116.....	121
ANNEX D18 – AG40312, AG40412, AG40314 AND AG40414 .....	128
ANNEX D19 – AH9035 .....	135
ANNEX D20 – AJ60416.....	137
ANNEX D21 – AJ80416.....	139
ANNEX D22 – AJ99416.....	141
ANNEX D23 – KNIGHT BRACKETS .....	143
ANNEX D24 – ES10 AND ES11 .....	148
ANNEX D25 – LS.....	154
ANNEX D26 – TAZ .....	157
ANNEX D27 – ABR170 AND ABR220 .....	159
ANNEX D28 – AB6983.....	164
ANNEX D29 – AB36125.....	165
ANNEX D30 – BNV33.....	167
ANNEX D31 – E5/1.5.....	169
ANNEX D32 – E5/2.....	178
ANNEX D33 – AT1 .....	185
ANNEX D34 – E4/2.5.....	191
ANNEX D35 – E6/2.....	195
ANNEX D36 – E6/2.5.....	201
ANNEX D37 – E7/2.5.....	207
ANNEX D38 – E8/2.5.....	213
ANNEX D39 – E14/2.....	219

ANNEX D40 – E17/2.....	222
ANNEX D41 – E18/2.5.....	228
ANNEX D42 – E19/3.....	233
ANNEX D43 – ADR6090.....	238
ANNEX D44 – ADR6035.....	241
ANNEX D45 – ABAl105.....	243
ANNEX D46 – AG922 .....	245
ANNEX D47 – ABR10525 .....	249
ANNEX D48 – ABR7015 .....	254
ANNEX D49 – ACR / ACRL.....	258
ANNEX D50 – MAXIMUS .....	268
ANNEX D51 – AT2.....	272
ANNEX D52 - ABR865.....	275
ANNEX D53 - ACFET200 / ACFET200PP.....	278
ANNEX D54 - ANP .....	280
ANNEX D55 –A-BRACKET.....	285
ANNEX D56 - ABR98.....	288
ANNEX D57 - AB105/513 .....	290

Translations of this European Technical Assessment in other languages shall fully correspond to the original issued document and should be identified as such.

Communication of this European Technical Assessment, including transmission by electronic means, shall be in full (excepted the confidential Annex(es) referred to above). However, partial reproduction may be made, with the written consent of the issuing Technical Assessment Body. Any partial reproduction has to be identified as such.



## II SPECIAL CONDITIONS OF THE EUROPEAN TECHNICAL ASSESSMENT

### 1 Technical description of product and intended use

#### Technical description of the product

This ETA covers the following angle bracket types: ABR90, AB90, ABR105, AB105, ABR70, AB70, E20/3, E9/2.5, E9S/2.5, ABR9015, ABR9020, ABR100, AA60280, ABB40390, AE48, AE76, AE116, AG40312, AG40412, AG40314, AG40414, AH9035, AJ60416, AJ80416, AJ99416, ES, LS, TAZ, KNAG, ABR170, ABR220, AB6983, AB36125, BNV33, E5, AT1, E4, E6, E7, E8, E14, E17, E18, E19, ADR6090, ADR6035, ABAI, AG922, ABR10525, ABR7015, ACR, MAXIMUS, AT2, ABR865, ANP, A-bracket, ACFET, ABR98 and AB105/513

The angle brackets are one piece, non-welded, timber-to-timber angle brackets/timber to support (concrete, steel) angle brackets. They are connected to the timber elements/support by a range of nails, screws or bolts.

The angle brackets are made from pre-galvanized steel Grade S250GD + Z275 according to EN 10346 with tolerances according to EN 10143 except if another material is precised. Material, dimensions and nail positions are shown in Annex D and typical installations are shown in Annex B.

All the angle brackets can also be produced from stainless steel number 1.4401, 1.4404, 1.4521, 1.4301 or 1.4509 according to EN 10088-2:2005 or a stainless steel with a minimum characteristic 0.2% yield stress of 240 MPa, a minimum 1.0% yield stress of 270 MPa and a minimum ultimate tensile strength of 530 MPa..

### 2 Specification of the intended use in accordance with the applicable EAD

The angle brackets are intended for use in making connections in load bearing structures, as a connection between two timber beams or a timber beam and a timber post or between a timber member and a concrete/steel member, where requirements for mechanical resistance and stability and safety in use in the sense of the Basic Works Requirements 1 and 4 of Regulation (EU) 305/2011 shall be fulfilled.

The connection may be with a single angle bracket or with an angle bracket on each side of the fastened timber member.

The static and kinematic behaviour of the timber members or the supports shall be as described in Annex C.

The wood members can be of solid timber, glued laminated timber and similar glued members, or wood-based structural members with a characteristic density from 290 kg/m<sup>3</sup> to 420 kg/m<sup>3</sup>.

This requirement to the material of the wood members can be fulfilled by using the following materials:

- Solid timber classified to C14-C40 according to EN 338 / EN 14081
- Glued members of timber classified to C14-C40 according to EN 338 / EN 14081 when structural adhesives are used.
- Glued laminated timber classified to GL24c or better according to EN 1194 / EN 14080.
- Solid Wood Panels, SWP according to EN 13353.
- Laminated Veneer Lumber LVL according to EN 14374
- Laminated Strand Lumber, e.g. Parallam and Timber Strand
- Plywood according to EN 636
- Oriented Strand Board, OSB according to EN 300

Annex D states the load-carrying capacities of the Angle Bracket connections for a characteristic density of 350 kg/m<sup>3</sup>. For timber or wood based material with a lower characteristic density than 350 kg/m<sup>3</sup> the load-carrying capacities shall be reduced by the  $k_{dens}$  factor (see Annex C4-2)

The design of the connections shall be in accordance with Eurocode 5 or a similar national Timber Code. The wood members shall have a thickness which is larger than the penetration depth of the nails into the members

The angle brackets may also be used for connections between a timber member and a member of concrete, steel or masonry.

The angle brackets are primarily for use in timber structures subject to the dry, internal conditions defined by service class 1 and 2 of Eurocode 5 and for connections subject to static or quasi-static loading.

The angle brackets can also be used in outdoor timber structures, service class 3, when a corrosion protection in accordance with Euro Code 5 is applied, or when stainless steel with similar or better characteristic yield and ultimate strength is employed.

The scope of the hangers regarding resistance to corrosion shall be defined according to national provisions that apply at the installation site considering environmental conditions and in conjunction with the admissible service conditions according to EN 1995-1-1 and the admissible corrosivity category as described and defined in EN ISO 12944-2

The provisions made in this European Technical Assessment are based on an assumed intended working life of the angle brackets of 50 years.

The indications given on the working life cannot be interpreted as a guarantee given by the producer or Assessment Body, but are to be regarded only as a means for choosing the right products in relation to the expected economically reasonable working life of the works.

### 3 Characteristics of product and assessment

Characteristic	Assessment of characteristic
<b>3.1 Mechanical resistance and stability*) (BWR1)</b>	
Characteristic load-carrying capacity	See Annex D
Stiffness	No performance determined
Ductility in cyclic testing	No performance determined
<b>3.2 Safety in case of fire (BWR2)</b>	
Reaction to fire	The angle brackets are made from steel classified as <b>Euroclass A1</b> in accordance with EN 13501-1 and EC decision 96/603/EC, amended by EC Decision 2000/605/EC
<b>3.3 Hygiene, health and the environment (BWR3)</b>	
Influence on air quality	The product does not contain/release dangerous substances specified in TR 034, dated March 2012
<b>3.7 Sustainable use of natural resources (BWR7)</b>	
	Not relevant
<b>3.8 General aspects related to the performance of the product</b>	
	The angle brackets have been assessed as having satisfactory durability and serviceability when used in timber structures using the timber species described in Eurocode 5 and subject to the dry internal conditions defined by service class 1, 2 and 3
<b>Identification</b>	See Annex D

\*) See additional information in section 3.9 – 3.12.

### 3.9 Methods of verification

#### Safety principles and partial factors

The characteristic load-carrying capacities have been calculated considering different ratios between the partial factors for timber connections and steel cross sections.

According to clause 6.3.5 of EN 1990 (Eurocode – Basis of structural design) the characteristic resistance for structural members that comprise more than one material acting in association should be calculated as

$$R_d = \frac{1}{\gamma_{M,1}} R \left\{ \eta_1 X_{k,1}; \eta_i X_{k,i(i>1)} \frac{\gamma_{m,1}}{\gamma_{m,i}}; a_d \right\}$$

where  $\gamma_{M,1}$  is the global partial factor for material 1 (in this case wood),  $\gamma_{m,1}$  is the partial factor on the material and  $\gamma_{m,i}$  are material partial factors for the other materials, i.e. the calculations are made with material parameters modified by multiplication by

$$k_{modi} = \gamma_{m,1} / \gamma_{m,i}$$

The characteristic load-carrying capacities have been calculated considering a ratio between the partial factor for timber connections and steel cross sections

$$k_{modi} = 1,18 \quad (EC5: k_{modi} = \frac{1,30}{1,10} = 1,18)$$

For  $k_{modi} > 1,18$  the load-carrying capacities stated in Annex D are valid (on the safe side).

For  $k_{modi} < 1,18$  the load-carrying capacities stated in Annex D have to be multiplied by a factor

$$f = \frac{k_{modi}}{1,18}$$

#### 3.10 Mechanical resistance and stability

See annex D for characteristic load-carrying capacity in the different directions  $F_1$  to  $F_5$ .

The characteristic capacities of the angle brackets are determined by calculation assisted by testing as described in the EOTA Guideline 015 clause 5.1.2. They should be used for designs in accordance with Eurocode 5 or a similar national Timber Code.

No performance has been determined in relation to ductility of a joint under cyclic testing. The contribution to the performance of structures in seismic zones, therefore, has not been assessed.

No performance has been determined in relation to the

joint's stiffness properties - to be used for the analysis of the serviceability limit state.

#### Fasteners

The load bearing capacities of the brackets have been determined based on the use of Connector nails CNA or connector screws CSA in accordance with ETA-04/0013. It is allowed to use other connector nails or connector screws in accordance with the standard EN 14592 with the same or better performance than the used 4,0 mm CNA Connector nails and still achieve the same load-bearing capacity of the connection.

For some brackets the load bearing capacities have been determined based on the use of bolts or powder actuated pins.

For any other information about fasteners or characteristic capacity modification method for different fasteners please see Annex C4-1.

The angle brackets can be mounted using different nail/screw patterns. The nail/screw patterns for each angle bracket and different connection type is described and shown in annex D.

#### Stainless steel

All the angle brackets can also be produced from stainless steel number 1.4401, 1.4404, 1.4521, 1.4301 or 1.4509 according to EN 10088-2:2005 or a stainless steel with a minimum characteristic 0.2% yield stress of 240 MPa, a minimum 1.0% yield stress of 270 MPa and a minimum ultimate tensile strength of 530 MPa.. The characteristic load carrying capacities can be considered as the same as those published in this document subject to the use of stainless CNA connector nails or CSA connector screws covered by the ETA-04/0013 or stainless threaded nails or screws in accordance to the standard EN 14592 respecting the rules given in the paragraph "fasteners" above.

#### 3.11 Aspects related to the performance of the product

##### 3.11.1 Corrosion protection in service class 1 and 2.

In accordance with ETAG 015 shall the angle bracket have a zinc coating weight of Z275. The steel employed is S250 GD with Z275 according to EN 10346.

##### 3.11.2 Corrosion protection in service class 3.

In accordance with Eurocode 5 the angle brackets shall be produced from stainless steel.

### **3.12 General aspects related to the use of the product**

Simpson Strong-Tie angle brackets types ABR90, AB90, ABR105, AB105, ABR70, AB70, E20/3, E9/2.5, E9S/2.5, ABR9015, ABR9020, ABR100, AA60280, ABB40390, AE48, AE76, AE116, AG40312, AG40412, AG40314, AG40414, AH9035, AJ60416, AJ80416, AJ99416, ES, LS, TAZ, KNAG, ABR170, ABR220, AB6983, AB36125, BNV33, E5, AT1, E4, E6, E7, E8, E14, E17, E18, E19, ADR6090, ADR6035, ABAI, AG922, ABR10525, ABR7015, ACR, MAXIMUS, AT2, ABR865, ANP, A-bracket, ACFET, ABR98 and AB105/513 are manufactured in accordance with the provisions of this European Technical Assessment using the manufacturing processes as identified in the inspection of the plant by the notified inspection body and laid down in the technical documentation.

## **4 Assessment and verification of constancy of performance (AVCP)**

### **4.1 AVCP system**

According to the decision 97/638/EC of the European Commission<sup>1</sup>, as amended, the system(s) of assessment and verification of constancy of performance (see Annex V to Regulation (EU) No 305/2011) is 2+.

## **5 Technical details necessary for the implementation of the AVCP system, as foreseen in the applicable EAD**

Technical details necessary for the implementation of the AVCP system are laid down in the control plan deposited at ETA-Danmark

Issued in Copenhagen on 2014-10-14 by

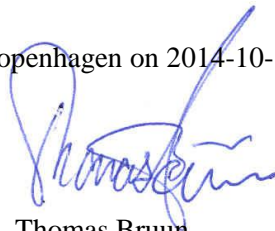

Thomas Bruun  
Managing Director, ETA-Danmark

**Annex A - Revision History**

<b>Modifications and additions to the previous ETA-06/0106 valid from 2013-05-28 to 2018-05-28</b>	
Pages	Update
	Adjustment from “approval” to “assessment”
	Annex C: added the description for using of one angle bracket
	Annex C4: added the possibility for interpolation by interim values
22ff	D1, D2, D3, D4: ABR90, AB90, ABR105, AB105 added capacities for connection to rigid support
52	Table D4-2: AB105 correction e to f , by $R_{1,k}$ for maximum nailing
97	D11: ABR9020, added values for beam-column
101ff	D12: ABR100, added values for nails 4,0x35, added minimum nailing
111ff	Figure D15-3, D16-3, D17-3, Type AE...: washer for force direction F2/3
129ff	D18:modified the values R2/3 for AG40312 and AG40412
148	D24: ES11: modified the drawing for size 40 to 80 and 100 to 200
159ff	D27, ABR170/220: connections/ values also valid for column to beam/rigid support, added values for $B < 60\text{mm}$
164ff	D28, D29, D30: AB6983, AB36125, BNV33, correction of $k_{\text{mod}}$ in the formulas, insert as “/ $k_{\text{mod}}$ ” for – values determine by the bolt
249	D47: ABR10525, material S350GD instead of S550DG (typing error)
253	D47: ABR10525 added values for beam-column
272	D51: AT2, long hole modified to 9x17mm (before with 8x16mm)
278ff	D-52 to D57: added ABR865, ACFET200 / ACFET200PP, ANP, A-brackets, ABR98, AB105/513
diverse	Annex: D-7, D-18, D-19, D-31 to D-44, D-51: Addition of bolt-factors

<b>Modifications and additions to the previous ETA-06/0106 valid from 2012-09-07 to 2016-10-13</b>	
Pages	Update
85+88+90	Table D11-3 + D11-5 minimum nailing of ABR9020
86+90	New table D11-6 ABR9020 fastening on steel with PAT pins
242+244	New table D47-3 ABR10525 fastening on steel with PAT pins
91+97	New table D12-7 ABR100 fastening on steel with PAT pins
254+255	Table D49-1 + D49-2 ACR7015/ACR9020/ACR10525 – other load directions
88+243+246+255	$R_{1,k}$ for connections with 2 angle brackets have been changed from calculated values to values based on tests for ABR9020, ABR10525, ABR7015 and ACR

<b>Modifications and additions to the previous ETA-06/0106 valid from 2011-10-13 to 2016-10-13</b>	
Pages	Update
	Table headings updated with “modified characteristic capacities” and old table no. deleted
86+87	Revision of capacity table D11-3 and D11-4 for ABR9020
230	Change measurement B on figure D44-1, ADR6035
237	Addition of ABR10525
241	Addition of ABR7015
244	Addition of ACR
250	Addition of MAXIMUS
254	Addition of AT2

<b>Modifications and additions to the previous ETA-06/0106 valid from 2011-05-25 to 2014-08-12</b>	
Pages	Update
	Merging of ETA-06/0106 + ETA-07/0055 + ETA-07/0194
25	Update of table D1-1 - 2 angle brackets ABR90
27	Update of Ø4.0x40 capacities in table D1-4 for ABR90 for minimum nailing
34	Update of table D2-1 - 2 angle brackets AB90
49	Update of table D4-1 - 2 angle brackets AB105
95	Update of table D12-3 – 2 angle brackets ABR100 with addition of $R_{4/5,k}$ capacities
96	Update of table D12-4 – 1 angle bracket ABR100 with addition of $R_{4,k}$ and $R_{5,k}$ capacities
156	Addition of $F_k$ capacities for ABR170 and ABR220 for timber to concrete connection (table D28-2)
162 - 229	Revision of capacity tables according to ETA-04/0013 for annex D32 to D43
230	Update of capacity tables D44-2 for ADR6090 $R_{1,k}$ for concrete structure
234	Addition of AB1105
236	Addition of AG922

<b>Modifications and additions to the previous ETA-06/0106 valid from 2009-08-12 to 2014-08-12</b>	
Pages	Update
87	ABR100 nail for use in concrete have been added



<b>Modifications and additions to the previous ETA-06/0106 valid from 2008-10-27 to 2013-10-27</b>	
Pages	Update
6,9	Add of the possible production of the brackets in stainless steel.
13	4.0x35 and 4.2x35 connector nails have been added.
13,16	Angle bracket ABR100 have been added
27	ABR100 nail pattern have been added.
28	The formulas for combined forces have been revised.
75, 76,79,80	F <sub>4</sub> and F <sub>5</sub> have been added for ABR9015 and ABR9020 for screws
77,78,81,82	F1, F2/F3 have been added for ABR9015 and ABR9020 for nails
83,84,85, 86	F1, F2/F3 have been added for ABR100 for nails and screws (1 and 2 brackets)

<b>Modifications and additions to the previous ETA-06/0106 valid from 2007-08-22 to 2012-08-22</b>	
Pages	Update
6	The formula for $k_{dens}$ has been changed from the power of 2 to the power of 1
16, 27, 75, 76	Angle Bracket 9015 has been added
16, 27, 77, 78	Angle Bracket 9020 has been added
32-74	Revision of capacity tables according to ETA-04/0013

## Annex B - Typical installation

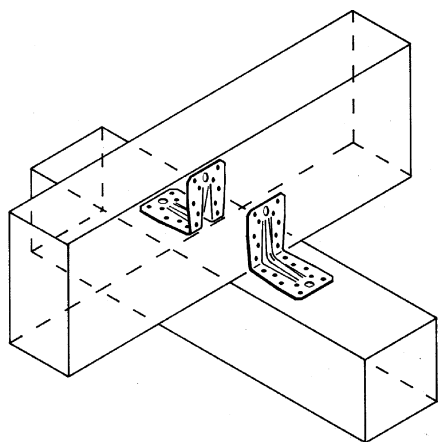

FIGURE B1 - BEAM TO BEAM CONNECTION

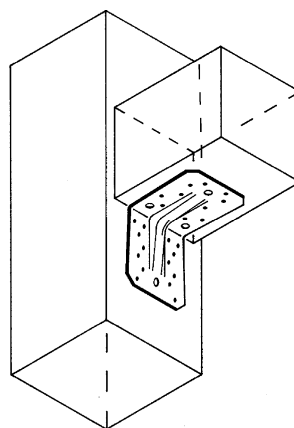

FIGURE B2 - BEAM TO COLUMN CONNECTION

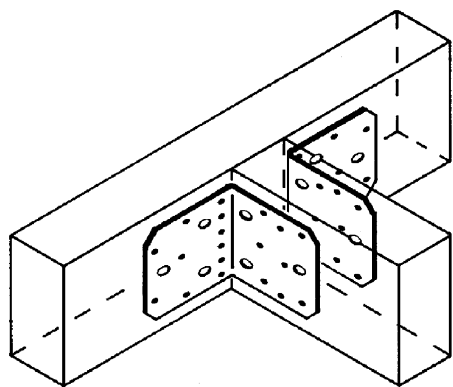
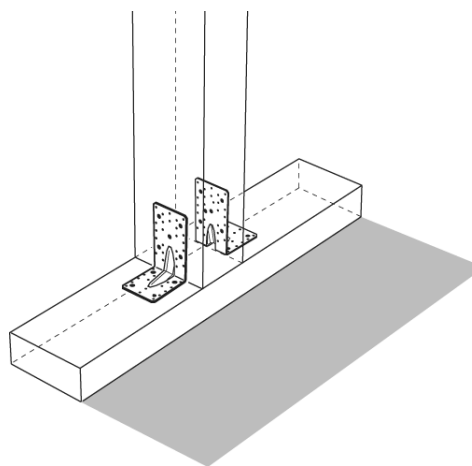

FIGURE B3 - TRIMMER CONNECTION



FIGURER B4 - POST TO BEAM CONNECTION

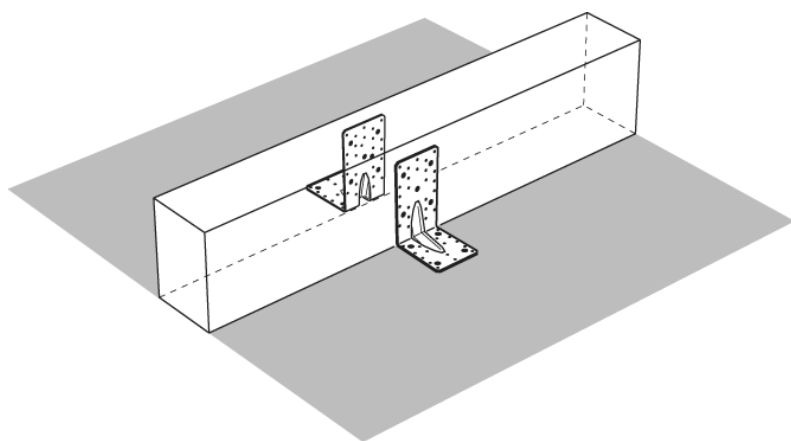

FIGURE B5 - BEAM TO RIGID SUPPORT WITH BOLTS

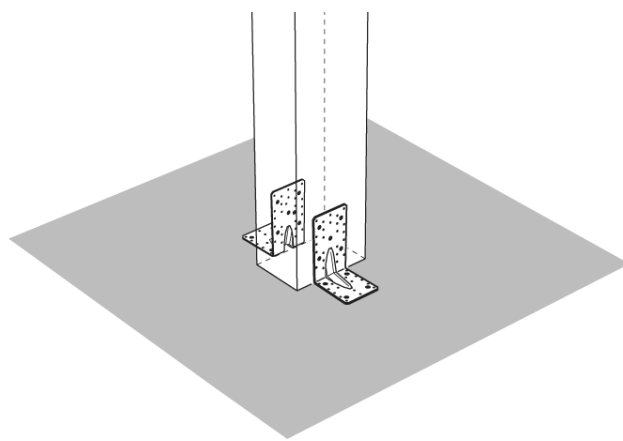

FIGURE B6 - POST TO RIGID SUPPORT WITH BOLTS

Above are shown all the typical installation. Any other particular installation is described in the Annex D for the specific product.

## Annex C - Basis of design

### Annex C1 – Basis of Design

All the general basis of design are given here. This rules applied to all products listed in this ETA except if something else is precised in Annex D for a particular product.

Most of the capacities stated in the Annex D tables are modified characteristic capacities  $R_{k,mod}$ . It means that the capacity given for a load duration category (P,L,M,S or I) already takes into account the  $k_{mod}$  factor. The design capacities are obtained according to the following formula.

$$R_d = \frac{R_k \cdot k_{mod}}{\gamma_M} = \frac{R_{k,mod}}{\gamma_M}$$

Some of the capacities stated in the Annex D tables are characteristic capacities  $R_k$ . Therefore the design capacities are obtained according to the following formula:

$$R_d = \frac{R_k \cdot k_{mod}}{\gamma_M}$$

#### Combined forces

For practical purposes the strength verification is always carried out for design forces and design capacities.

For all angle brackets included in this ETA the following inequalities shall be fulfilled:

$F_1$  combined with  $F_2$  or  $F_3$ :

$$\left( \frac{F_{1,d}}{R_{1,d}} \right)^2 + \left( \frac{F_{2or3,d}}{R_{2or3,d}} \right)^2 \leq 1$$

$F_1$  combined with  $F_4$  or  $F_5$ :

$$\frac{F_{1,d}}{R_{1,d}} + \frac{F_{4or5,d}}{R_{4or5,d}} \leq 1$$

$F_1$  combined with  $F_2$  or  $F_3$  and  $F_4$  or  $F_5$ :

$$\sqrt{\left[ \frac{F_{1,d}}{R_{1,d}} + \frac{F_{4or5,d}}{R_{4or5,d}} \right]^2 + \left[ \frac{F_{2or3,d}}{R_{2or3,d}} \right]^2} \leq 1,0$$

#### Timber splitting

For the lifting force  $F_1$  acting perpendicular to the grain in the timber it must be checked that splitting will not occur in accordance with Eurocode 5 or a similar national Timber Code.

## Annex C2 – Definition of forces direction

### C2-1 : Forces - Beam to beam connection, beam to support with bolts

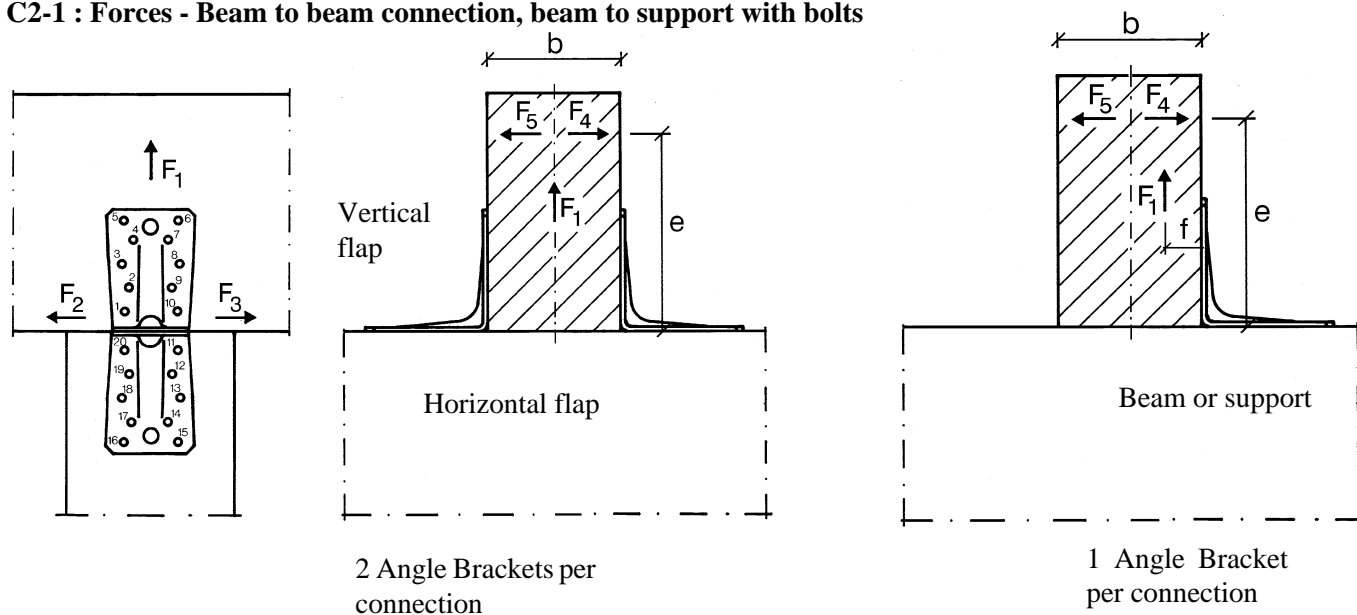

Figure C2-1: Beam to beam connection, beam to support with bolts

#### 2 angle brackets per connection

The angle brackets must be placed at each side opposite to each other.

#### Acting forces

- $F_1$  Lifting force acting along the central axis of the joint.
- $F_2$  and  $F_3$  Lateral force acting in the joint between the purlin and beam in the purlin direction.
- $F_4$  and  $F_5$  Lateral force acting in the beam direction along the central axis of the joint but elevated  $e$  above the beam.

#### 1 angle bracket per connection

##### Acting forces

- $F_1$  Lifting force acting in the central axis of the angle bracket but in a distance  $f$  from the vertical flap of the angle bracket.  
If the purlin is prevented from rotation the load-carrying capacity will be half that of a connection with 2 angle brackets.
- $F_2$  and  $F_3$  Lateral force acting in the joint between the purlin and the beam in the purlin direction, the purlin have to be prevented from twisting.
- $F_4$  Lateral force acting in the beam direction perpendicular to the vertical flap elevated  $e$  above the beam directed towards the angle brackets vertical flap.
- $F_5$  Lateral force acting in the beam direction perpendicular to the vertical flap elevated  $e$  above the beam directed away from the angle brackets vertical flap.

#### Wane on under the flap towards the purlin

For most of the angle brackets wane under the flap towards the purlin is allowed provided it does not occur under the fasteners.

Under each table in Annex D is indicated weather wane is allowed or not allowed.

**C2-2 : Forces – Beam to column connection**

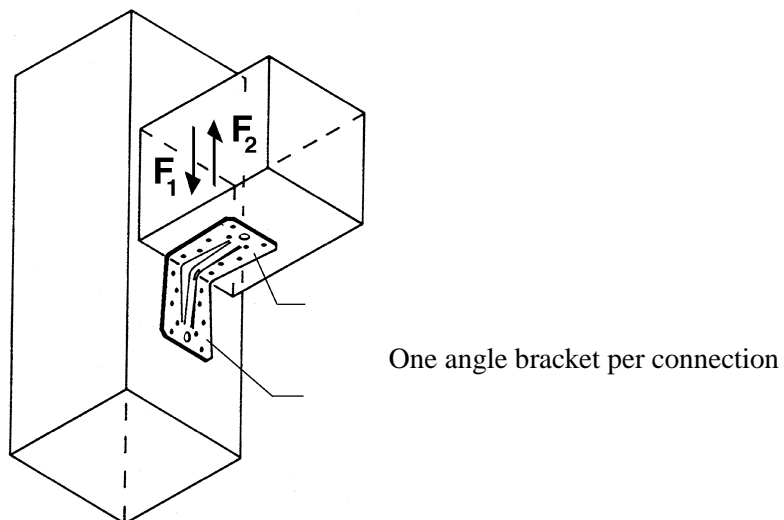

Figure C2-2-1: Beam to column connection – Angle bracket with a rib

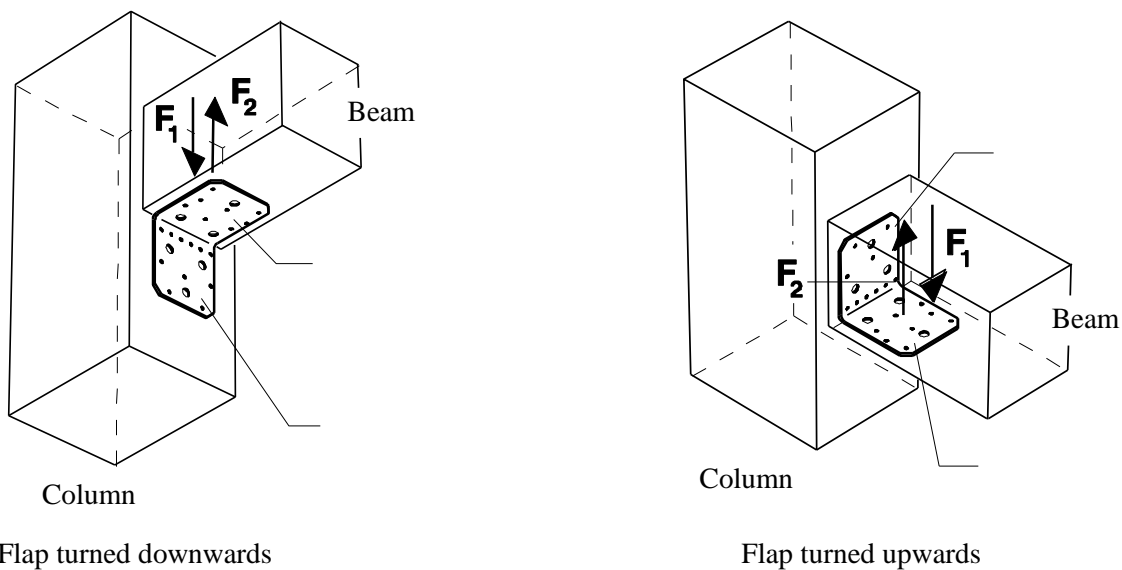

Figure C2-2-2: Beam to column connection – Angle bracket without a rib

*1 angle bracket per connection*

*Acting forces*

$F_1$  Downward force acting along the central axis of the angle bracket.

$F_2$  Lifting force acting along the central axis of the angle bracket..

### C2-3 : Forces – Post to beam connection, post to support with bolts

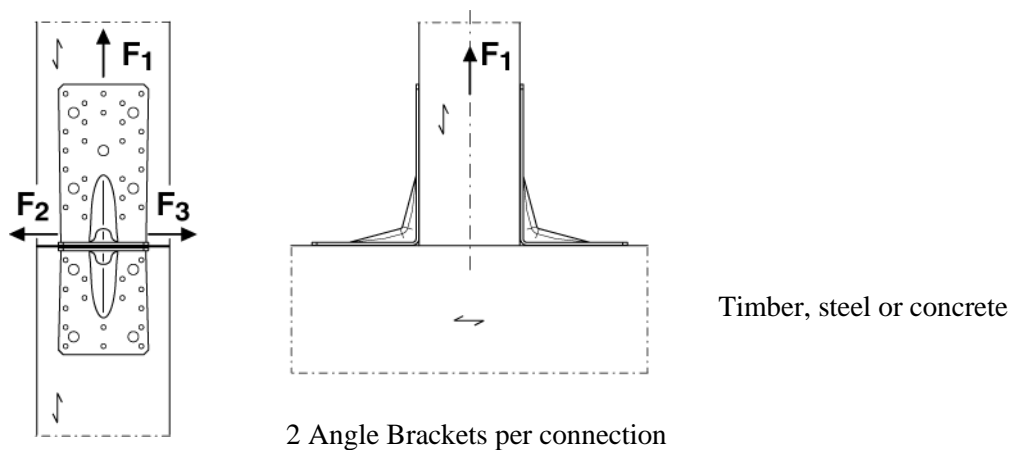

Figure C2-3: Post to beam connection, post to support with bolts

#### 2 angle brackets per connection

The angle brackets must be placed at each side opposite to each other.

#### Acting forces

$F_1$  Lifting force acting along the central axis of the joint.

$F_2$  and  $F_3$  Lateral force acting in the joint between the post and the beam parallel to the bend line in the angle bracket.

#### 1 angle bracket per connection

The load-carrying capacities will be half of that of a connection with 2 angle brackets per connection, the post have to be prevented from twisting.

#### Wane

The timber shall have plane surfaces under the angle bracket which means that wane may not occur under the angle bracket.

**C2-4 : Forces – Trimmer connection**

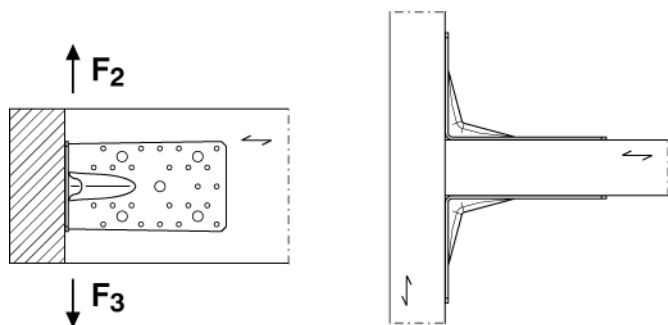

Figure B3: Trimmer connection

**2 angle brackets per connection**

The angle brackets must be placed at each side opposite to each other.

**Acting forces**

$F_2$  and  $F_3$  Lateral force parallel to the bend line in the angle bracket in the joint between the joist and the header.

**1 angle bracket per connection**

The load-carrying capacities will be half of that of a connection with 2 angle brackets per connection, the post has to be prevented from twisting.

**Wane**

The timber shall have plane surfaces under the angle bracket which means that wane may not occur under the angle bracket.

**C2-5 : Connection with bolts**

Below the load-tables for connection with bolts are given factors.

It has to be checked, that the bolt has a capacity to absorb the resultant overlapping forces.

$$R_{\text{bolt ax/lat}} \geq \text{factor}_{\text{ax/lat}} \times \text{acting load.}$$

The factor  $k_{\text{lat}}$  is given to determine the shear load for the bolt

The factor  $k_{\text{ax}}$  is given to determine the axial load for the bolt

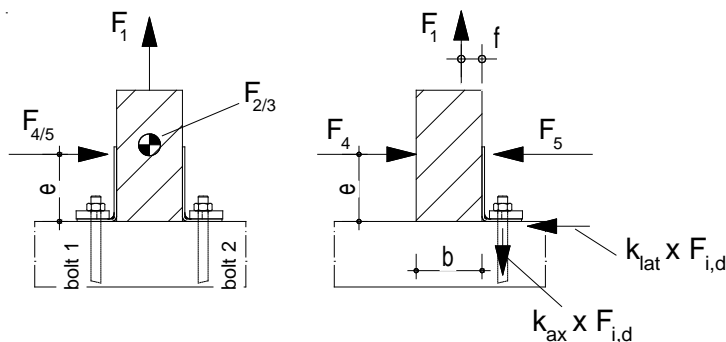

Each bolt shall have a capacity to sustain a lateral force of:  $\geq k_{\text{lat}} \times F_{i,d}$

Each bolt shall have a capacity to sustain a axial force of:  $\geq k_{\text{ax}} \times F_{i,d}$

Combinations of loads have to be considered.

**Annex C3 – Fasteners specification and capacities**

CNA connector nails and CSA connector screws according to ETA-04/0013 :

Nail and screw type	Nail and screw size (mm)		Finish
	Diameter	Length	
According to ETA-04/0013 annex A drawing 1 and 2			
Connector nail	3,1	--	Electroplated zinc
Connector nail	3,7	50	Electroplated zinc
Connector nail	4,0	35	Electroplated zinc
Connector nail	4,0	40	Electroplated zinc
Connector nail	4,0	50	Electroplated zinc
Connector nail	4,0	60	Electroplated zinc
Connector screw	5,0	35	Electroplated zinc
Connector screw	5,0	40	Electroplated zinc
Connector screw	5,0	50	Electroplated zinc
Connector nail	4,2	35	Electroplated zinc
Connector nail	4,2	50	Electroplated zinc
Connector nail	4,2	60	Electroplated zinc

Other fasteners :

Nail, screw and bolt type	Nail, screw and bolt size (mm)		Finish
	Diameter	Length	
Threaded nail according to EN 14592	3,1	--	Electroplated zinc
Smooth nail according to EN 14592	3,75	75	Hot-dip galvanized
Threaded nail according to EN 14592	4,0	--	Electroplated zinc
PDPA-75	4,0	19	Electroplated zinc
Wood screw	6,0	45	Electroplated zinc
Bolt M8	8		For relevant angle brackets see the assumed characteristic capacities of the bolt connection and compare with the specification of the manufacturer
Bolt M10	10		
Bolt M12	12		



## **Annex C4 – Characteristic capacity modification methods for nails and timber types**

### **C4 – 1 : Characteristic capacity modification method for different nails**

#### **CNA Connector nails and CSA Connector screws in accordance to ETA-04/0013**

When the load bearing capacity of a bracket have been determined based on the use of Connector nails CNA 4,0x35, CNA4,0x40, CNA4,0x50 or CNA4,0x60 in accordance with ETA-04/0013 it is allowed to use longer 4,0 mm CNA Connector nails or Connector screws CSA5,0x35, CSA5,0x40, CSA 5,0x50 or Connector nails CNA4,2x35, CNA4,2x50, CNA4,2x60 in accordance with ETA-04/0013 with the same or better performance than the used 4,0 mm CNA Connector nails and still achieve the same load-bearing capacity of the connection.

When the load bearing capacity of a bracket have been determined based on the use of Connector screws it is always allowed to use a longer screw and the capacities will still be valid. If shorter Connector screws are used and no calculations are made a reduction factor equal to the ratio between the withdrawal capacity of the short screw and the withdrawal capacity of the long screw is applicable for all load bearing capacities of the connection.

It is always allowed to interpolate between two sizes of nails or screws. For example the capacity of Connector nails CNA 4,0x50 in accordance with ETA-04/0013 can be calculated as the mean value of the capacity of the connection when Connector nails CNA4,0x40 and CNA4,0x60 are used.

#### **Threaded nails in accordance to EN 14592**

For all angle brackets the design models also allow the use of threaded nails in accordance to EN 14592 with a diameter in the range 4,0 – 4,2 mm and a minimum length of 35 mm, assuming a thick steel plate when calculating the lateral nail load-bearing capacity. If no calculations are made a reduction factor equal to the ratio between the characteristic withdrawal capacity of the actual used threaded nail and the characteristic withdrawal capacity of the corresponding Connector nail according to table B1 in ETA-04/0013 is applicable for all load bearing capacities of the connection.

#### **Other fasteners**

For some angle brackets the load bearing capacities have been determined for a connection between a timber member and its support using bolts. It is assumed that the bolts have a certain characteristic lateral capacity and characteristic axial capacity (the assumed strength of the bolt is stated at the relevant angle bracket in Annex D). If one of the characteristic capacities of the chosen bolts is smaller the capacity of the connection shall be reduced proportionally.

For some angle brackets the load bearing capacities have been determined for a connection between a timber member and its support to a 6 mm steel member using PDPA-75 nails, which are powder actuated pins. The pins have been fastened through the existing holes in the angle brackets.

Some angle brackets gives the load bearing capacity for a connection between a timber member and a 6 mm steel quality S355. For this connection

#### **Stainless steel**

For the angle brackets produced from stainless steel number 1.4401, 1.4404, 1.4521, 1.4301 or 1.4509 according to EN 10088-2:2005 or a stainless steel with a minimum characteristic 0.2% yield stress of 240 MPa, a minimum 1.0% yield stress of 270 MPa and a minimum ultimate tensile strength of 530 MPa., the characteristic load carrying capacities can be considered as the same as those published in this document subject to the use of stainless CNA connector nails or CSA connector screws covered by the ETA-04/0013 or stainless threaded nails or screws in accordance to the standard EN 14592 respecting the rules given in the paragraph above for nails and screws according to ETA-04/0013 and EN14592.

### **C4 – 2 : Characteristic capacity modification method for different timber types**

Annex D states the load-carrying capacities of the Angle Bracket connections for a characteristic density of 350 kg/m<sup>3</sup>. For timber or wood based material with a lower characteristic density than 350 kg/m<sup>3</sup> the load-carrying capacities shall be reduced by the  $k_{dens}$  factor:

$$k_{dens} = \left( \frac{\rho_k}{350} \right) \quad \text{Where } \rho_k \text{ is the characteristic density of the timber in kg/m}^3.$$

For interim value, e.g. distances, it's allowed to determine the values by interpolation if nothing else is named by the current table.

## Annex D - Product definition and capacities

### Annex D1 – ABR90

#### Product Name:

Product Name	Alternative name			
	UK	France	Denmark	Germany
ABR90	E2/2.5/7090	E2/2.5/7090	--	90 m/R
ABR90S	--	E2IX	--	--
ABR90S2	--	--	--	--

#### Drawing:

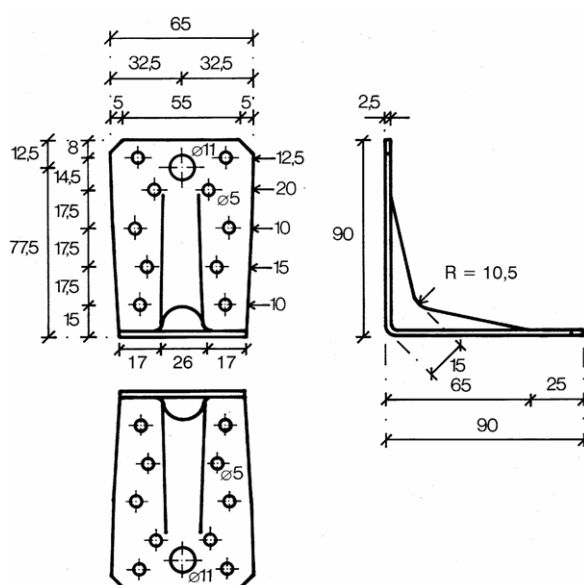

Figure D1-1 - ABR 90

#### Material:

Standard material : S250GD + Z275 according to EN 10346

Or stainless steel according to clause II-1

**Nail pattern:**

Beam to beam connection

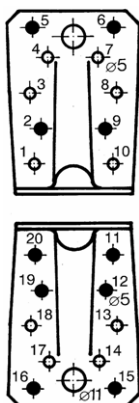

Figure D1-2  
Minimum nailing  
Nails in holes number  
2,5,6,9, / 11,12,15,16,19,20

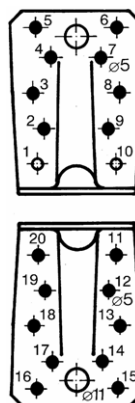

Figure D1-3  
Maximum nailing  
Nails in holes number  
2,3,4,5,6,7,8,9/  
11,12,13,14,15,16,17,18,19,  
20

Beam to column connection

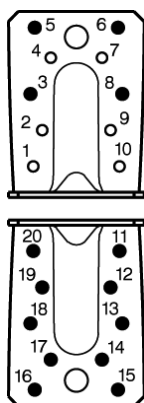

Figure D1-4  
Maximum nailing  
Nails in holes number  
3,5,6,8/  
11,12,13,14,15,16,17,18,19,20

Beam to rigid support connection

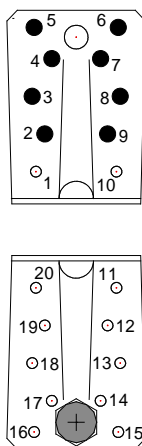

Figure D1-5  
Nailing  
nails in holes number  
2 to 9  
and 1 bolt

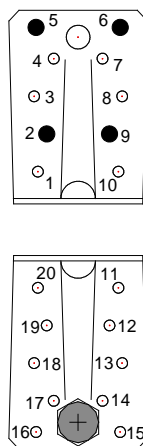

Figure D1-6  
Nailing  
nails in holes number  
2,5,6,9  
and 1 bolt

**Modified characteristic capacities:**

Table D1-1 2 Angle Brackets ABR90, beam to beam connection

2 ABR90 per connection				Modified characteristic capacity per connection (kN)				
Nailing	Load duration	R <sub>1,k</sub>		R <sub>2,k</sub> = R <sub>3,k</sub>		R <sub>4,k</sub> = R <sub>5,k</sub>		
		Connector nail according to ETA-04/0013						
		4,0x40	4,0x60	4,0x40	4,0x60	4,0x40	4,0x60	
<b>Minimum Nailing 4+6</b>  See fig. D1-2	P	3,2	5,3	3,4	4,4	$\frac{6,1 \cdot b + 431}{e - 10,7}$	$\frac{6,84 \cdot b + 430}{e - 10,7}$	
		1,0	2,3			max 5,1	max 7,2	
	L	3,7	6,2	4,0	5,1	$\frac{6,2 \cdot b + 431}{e - 10,7}$	$\frac{7,17 \cdot b + 430}{e - 10,7}$	
		1,3	3,0			max 5,6	max 8,0	
	M	4,3	7,1	4,6	5,9	$\frac{6,4 \cdot b + 431}{e - 10,7}$	$\frac{7,5 \cdot b + 430}{e - 10,7}$	
		1,6	3,7			max 6,1	max 8,9	
	S	4,8	8,0	5,1	6,6	$\frac{6,6 \cdot b + 431}{e - 10,7}$	$\frac{7,83 \cdot b + 429}{e - 10,7}$	
		2,0	4,5			max 6,7	max 9,8	
	I	5,9	9,7	6,3	8,1	$\frac{7,0 \cdot b + 430}{e - 10,7}$	$\frac{8,49 \cdot b + 429}{e - 10,7}$	
		2,7	6,4			max 7,7	max 11,5	
	<b>Maximum Nailing 8+10</b>  See fig. D1-3	P	4,8	8,0	5,6	7,1	$\frac{6,3 \cdot b + 431}{e - 10,7}$	$\frac{7,2 \cdot b + 430}{e - 10,7}$
			1,4	3,2			max 7,8	max 11,7
L		5,6	9,3	6,5	8,3	$\frac{6,5 \cdot b + 431}{e - 10,7}$	$\frac{7,59 \cdot b + 429}{e - 10,7}$	
		1,8	4,2			max 8,8	max 13,4	
M		6,4	10,6	7,4	9,5	$\frac{6,7 \cdot b + 430}{e - 10,7}$	$\frac{7,98 \cdot b + 429}{e - 10,7}$	
		2,2	5,3			max 9,7	max 15,0	
S		7,1	12,0	8,3	10,6	$\frac{7,0 \cdot b + 430}{e - 10,7}$	$\frac{8,37 \cdot b + 429}{e - 10,7}$	
		2,7	6,5			max 10,7	max 16,6	
I		8,7	14,6	10,2	13,0	$\frac{7,4 \cdot b + 430}{e - 10,7}$	$\frac{9,15 \cdot b + 428}{e - 10,7}$	
		3,8	9,0			max 12,7	max 19,9	

b and e are in mm.

■ When the purlin has a wane on the side towards the Angle Bracket with an extent from the bottom up to the lower nail the value in the grey square is valid.

Table D1-2 1 Angle Bracket ABR90, beam to beam connection

Load duration: P		1 Angle Bracket per connection		Modified characteristic capacity per connection (kN)			
R <sub>1,k</sub>		R <sub>2,k</sub> = R <sub>3,k</sub>		R <sub>4,k</sub>		R <sub>5,k</sub>	
Connector nail according to ETA-04/0013:							
4,0x40	4,0x60	4,0x40	4,0x60	4,0x40	4,0x60	4,0x40	4,0x60
<b>Minimum nailing: 4+6 (fig. D1-2)</b>							
f <sub>≤</sub> 40: <u>78</u> f+60	f <sub>≤</sub> 49: <u>114</u> f+60	1,7	2,2	e < 37,5: <u>30,6</u> 37,5-e	e < 37,5: <u>50,9</u> 37,5-e	e ≤ 58: <u>31</u> 68-e	e ≤ 55: <u>52</u> 68-e
				e ≤ 37: 2,2	e ≤ 42: 2,83	58 < e ≤ 1,83·b:	55 < e ≤ 1,62·b+3:
f > 40: <u>31,1</u> f	f > 49: <u>51,7</u> f	1,7	2,2	37 < e ≤ 101: <u>81</u> e	42 < e ≤ 109: <u>119,8</u> e	3,3	4,2
				e > 101: <u>28,9</u> e-65	e > 109: <u>48</u> e-65	e > 1,83·b:	e > 1,62·b+3:
<b>Maximum nailing: 8+10 (fig. D1-3)</b>							
f <sub>≤</sub> 34: <u>85</u> f+60	f <sub>≤</sub> 41: <u>127</u> f+60	2,8	3,5	e < 37,5: <u>37,5</u> 37,5-e	e < 37,5: <u>62,7</u> 37,5-e	e ≤ 57: <u>46,3</u> 68-e	e ≤ 54: <u>77,5</u> 68-e
				e ≤ 20: 4,4	e ≤ 23: 5,66	57 < e ≤ 1,47·b+10:	54 < e ≤ 1,23·b+15:
f > 34: <u>30,9</u> f	f > 41: <u>51,7</u> f	2,8	3,5	20 < e ≤ 96: <u>89</u> e	23 < e ≤ 102: <u>133,1</u> e	4,3	5,8
				e > 96: <u>28,7</u> e-65	e > 102: <u>48</u> e-65	e > 1,47·b+10:	e > 1,23·b+15:
						<u>6,3·b-247</u> e-68	<u>7,2·b-308</u> e-68

b, e and f are in mm.

When the purlin has a wane on the side towards the Angle Bracket with an extent from the bottom up to the lower nail the formula in the grey square shall be checked additionally.

Table D1-3 1 Angle Bracket ABR90, beam to beam connection

Load duration: L		1 Angle Bracket per connection		Modified characteristic capacity per connection (kN)			
$R_{1,k}$		$R_{2,k} = R_{3,k}$		$R_{4,k}$		$R_{5,k}$	
Connector nail according to ETA-04/0013:							
4,0x40	4,0x60	4,0x40	4,0x60	4,0x40	4,0x60	4,0x40	4,0x60
<b>Minimum nailing: 4+6 (fig. D1-2)</b>							
$f \leq 43$ : $\frac{87}{f+60}$	$f \leq 52$ : $\frac{130}{f+60}$	2,0	2,6	$e < 37,5$ : $\frac{35,7}{37,5-e}$	$e < 37,5$ : $\frac{59,4}{37,5-e}$	$e \leq 57$ : $\frac{36}{68-e}$	$e \leq 54$ : $\frac{69}{68-e}$
				$e \leq 36$ : 2,6	$e \leq 41$ : 3,3	$57 < e \leq 1,77 \cdot b + 1$ :	$54 < e \leq 1,51 \cdot b + 5$ :
$f > 43$ : $\frac{36,3}{f}$	$f > 52$ : $\frac{60,3}{f}$	2,0	2,6	$36 < e \leq 103$ : $\frac{91}{e}$	$41 < e \leq 111$ : $\frac{135,8}{e}$	3,5	5,0
				$e > 103$ : $\frac{33,7}{e-65}$	$e > 111$ : $\frac{56}{e-65}$	$e > 1,77 \cdot b + 1$ :	$e > 1,51 \cdot b + 5$ : $\frac{7,52 \cdot b - 310}{e-68}$
<b>Maximum nailing: 8+10 (fig. D1-3)</b>							
$f \leq 36$ : $\frac{96}{f+60}$	$f \leq 43$ : $\frac{144}{f+60}$	3,2	4,1	$e < 37,5$ : $\frac{43,7}{37,5-e}$	$e < 37,5$ : $\frac{73,2}{37,5-e}$	$e \leq 56$ : $\frac{54}{68-e}$	$e \leq 54$ : $\frac{90,4}{68-e}$
				$e \leq 19$ : 5,1	$e \leq 23$ : 6,61	$56 < e \leq 1,39 \cdot b + 11$ :	$54 < e \leq 1,17 \cdot b + 16$ :
$f > 36$ : $\frac{36}{f}$	$f > 43$ : $\frac{60,3}{f}$	3,2	4,1	$19 < e \leq 99$ : $\frac{100}{e}$	$23 < e \leq 103$ : $\frac{151,3}{e}$	4,7	6,5
				$e > 99$ : $\frac{33,4}{e-65}$	$e > 103$ : $\frac{56}{e-65}$	$e > 1,39 \cdot b + 11$ : $\frac{6,5 \cdot b - 262}{e-68}$	$e > 1,17 \cdot b + 16$ : $\frac{7,59 \cdot b - 333}{e-68}$

b, e and f are in mm.

When the purlin has a wane on the side towards the Angle Bracket with an extent from the bottom up to the lower nail the formula in the grey square shall be checked additionally.

Table D1-4 1 Angle Bracket ABR90, beam to beam connection

Load duration: M		1 Angle Bracket per connection		Modified characteristic capacity per connection (kN)			
$R_{1,k}$		$R_{2,k} = R_{3,k}$		$R_{4,k}$		$R_{5,k}$	
Connector nail according to ETA-04/0013:							
4,0x40	4,0x60	4,0x40	4,0x60	4,0x40	4,0x60	4,0x40	4,0x60
<b>Minimum nailing: 4+6 (fig. D1-2)</b>							
f≤45: <u>96</u> f+60	f≤55: <u>145</u> f+60	2,3	2,9	e<37,5: <u>40,8</u> 37,5-e	e<37,5: <u>67,9</u> 37,5-e	e≤56: <u>41</u> 68-e	e≤54: <u>69</u> 68-e
				e≤34: 2,9	e≤40: 3,78	56<e≤1,71·b+2:	54<e≤1,51·b+5:
f>45: <u>41,4</u> f	f>55: <u>68,9</u> f	2,3	2,9	34<e≤105: <u>101</u> e	40<e≤112: <u>151,9</u> e	3,8	5,0
				e>105: <u>38,5</u> e-65	e>112: <u>64</u> e-65	e>1,71·b+2:	e>1,51·b+5:
<b>Maximum nailing: 8+10 (fig. D1-3)</b>							
f≤38: <u>106</u> f+60	f≤45: <u>161</u> f+60	3,7	4,7	e<37,5: <u>50</u> 37,5-e	e<37,5: <u>83,6</u> 37,5-e	e≤55: <u>62</u> 68-e	e≤53: <u>103</u> 68-e
				e≤19: 5,9	e≤22: 7,55	55<e≤1,33·b+13:	53<e≤1,12·b+17:
f>38: <u>41,2</u> f	f>45: <u>68,9</u> f	3,7	4,7	19<e≤99: <u>111</u> e	22<e≤92: <u>169,6</u> e	5,0	7,1
				e>99: <u>38,2</u> e-65	92<e≤111: <u>109,5</u> e-32,5	e>1,33·b+13:	e>1,12·b+17:
				e>111: <u>64</u> e-65	<u>6,7·b-277</u> e-68	<u>7,98·b-359</u> e-68	

b, e and f are in mm.

When the purlin has a wane on the side towards the Angle Bracket with an extent from the bottom up to the lower nail the formula in the grey square shall be checked additionally.

Table D1-5 1 Angle Bracket ABR90, beam to beam connection

Load duration: S		1 Angle Bracket per connection		Modified characteristic capacity per connection (kN)			
R <sub>1,k</sub>		R <sub>2,k</sub> = R <sub>3,k</sub>		R <sub>4,k</sub>		R <sub>5,k</sub>	
Connector nail according to ETA-04/0013:							
4,0x40	4,0x60	4,0x40	4,0x60	4,0x40	4,0x60	4,0x40	4,0x60
<b>Minimum nailing: 4+6 (fig. D1-2)</b>							
f <sub>≤45</sub> : $\frac{106}{f+60}$	f <sub>≤57</sub> : $\frac{160}{f+60}$	2,6	3,3	e <sub>&lt;37,5</sub> : $\frac{40,8}{37,5-e}$	e <sub>&lt;37,5</sub> : $\frac{76,4}{37,5-e}$	e <sub>≤56</sub> : $\frac{47}{68-e}$	e <sub>≤53</sub> : $\frac{77}{68-e}$
				e <sub>≤34</sub> : 3,3	e <sub>≤40</sub> : 4,25	56<e≤1,67·b+3:	53<e≤1,46·b+6:
		34<e≤105: $\frac{110}{e}$	40<e≤93: $\frac{167,9}{e}$	4,0	5,3		
f <sub>&gt;45</sub> : $\frac{46,6}{f}$	f <sub>&gt;57</sub> : $\frac{77,5}{f}$	2,6	3,3		93<e≤127: $\frac{109,5}{e-32,5}$	e>1,67·b+3: $\frac{6,6·b-259}{e-68}$	e>1,46·b+6: $\frac{7,83·b-328}{e-68}$
				e>105: $\frac{43,3}{e-65}$	e>127: $\frac{72}{e-65}$		
<b>Maximum nailing: 8+10 (fig. D1-3)</b>							
f <sub>≤40</sub> : $\frac{116}{f+60}$	f <sub>≤46</sub> : $\frac{179}{f+60}$	4,2	5,3	e <sub>&lt;37,5</sub> : $\frac{76,1}{37,5-e}$	e <sub>&lt;37,5</sub> : $\frac{94,1}{37,5-e}$	e <sub>≤55</sub> : $\frac{69}{68-e}$	e <sub>≤53</sub> : $\frac{116}{68-e}$
				e <sub>≤18</sub> : 6,6	e <sub>≤22</sub> : 8,5	55<e≤1,28·b+14:	53<e≤1,08·b+18:
		18<e≤101: $\frac{122}{e}$	22<e≤79: $\frac{186,5}{e}$	5,4	7,8		
f <sub>&gt;40</sub> : $\frac{46,3}{f}$	f <sub>&gt;46</sub> : $\frac{77,5}{f}$	4,2	5,3		79<e≤127: $\frac{109,5}{e-32,5}$	e>1,28·b+14: $\frac{7,0·b-292}{e-68}$	e>1,08·b+18: $\frac{8,37·b-384}{e-68}$
				e>101: $\frac{43}{e-65}$	e>127: $\frac{72}{e-65}$		

b, e and f are in mm.

■ When the purlin has a wane on the side towards the Angle Bracket with an extent from the bottom up to the lower nail the formula in the grey square shall be checked additionally.



Table D1-6 1 Angle Bracket ABR90, beam to beam connection

Load duration: I		1 Angle Bracket per connection		Modified characteristic capacity per connection (kN)			
$R_{1,k}$		$R_{2,k} = R_{3,k}$		$R_{4,k}$		$R_{5,k}$	
Connector nail according to ETA-04/0013:							
4,0x40	4,0x60	4,0x40	4,0x60	4,0x40	4,0x60	4,0x40	4,0x60
<b>Minimum nailing: 4+6 (fig. D1-2)</b>							
f≤51: $\frac{124}{f+60}$	f≤60: $\frac{190}{f+60}$	3,1	4,0	e<37,5: $\frac{56,2}{37,5-e}$	e<37,5: $\frac{93,4}{37,5-e}$	e≤55: $\frac{57}{68-e}$	e≤52: $\frac{95}{68-e}$
				e≤32: 4,0	e≤36: 5,19	55<e≤1,58·b+4: 4,4	52<e≤1,39·b+7: 6,1
32<e≤95: $\frac{130}{e}$	36<e≤79: $\frac{186,5}{e}$						
f>51: $\frac{57}{f}$	f>60: $\frac{94,7}{f}$			95<e≤110: $\frac{109}{e-32,5}$	79<e≤198: $\frac{109,5}{e-32,5}$	e>1,58·b+4: $\frac{7,0·b-282}{e-68}$	e>1,39·b+7: $\frac{8,49·b-366}{e-68}$
		e>110: $\frac{52,9}{e-65}$	e>198: $\frac{87,9}{e-65}$				
<b>Maximum nailing: 8+10 (fig. D1-3)</b>							
f≤42: $\frac{137}{f+60}$	f≤48: $\frac{213}{f+60}$	5,1	6,5	e<37,5: $\frac{68,7}{37,5-e}$	e<37,5: $\frac{115}{37,5-e}$	e≤54: $\frac{85}{68-e}$	e≤52: $\frac{142}{68-e}$
				e≤18: 8,1	e≤18: 10,38	54<e≤1,20·b+16: 6,2	52<e≤1,01·b+20: 9,1
18<e≤103: $\frac{144}{e}$	18<e≤79: $\frac{186,5}{e}$						
f>42: $\frac{56,6}{f}$	f>48: $\frac{94,7}{f}$			e>103: $\frac{52,6}{e-65}$	79<e≤200: $\frac{109,5}{e-32,5}$	e>1,20·b+16: $\frac{7,4·b-322}{e-68}$	e>1,01·b+20: $\frac{9,15·b-435}{e-68}$
			e>200: $\frac{87,9}{e-65}$				

b, e and f are in mm.

■ When the purlin has a wane on the side towards the Angle Bracket with an extent from the bottom up to the lower nail the formula in the grey square shall be checked additionally.

Table D1-7 1 Angle Bracket ABR90, beam to column connection

Beam to column connection		Modified characteristic capacity per connection (kN)			
1 Angle Bracket ABR90		R <sub>1,k</sub>		R <sub>2,k</sub>	
Nailing	Load duration	Connector nail according to ETA-04/0013			
		4,0x40	4,0x60	4,0x40	4,0x60
Beam: 4 Column: 10  See fig. D1-4	P	5,4	6,6	0,9	1,5
	L	6,3	7,7	1,0	1,7
	M	7,2	8,8	1,2	2,0
	S	8,1	9,9	1,3	2,2
	I	9,9	12,1	1,6	2,7

End gab: max. 5 mm

Table D1-8 2 Angle Bracket ABR90, beam to rigid support connection

2 ABR90 per connection	characteristic capacities [kN] per connection							
	R <sub>1,k</sub>				R <sub>2/3,k</sub>			
	connector nails according to ETA-04/0013							
nailing	4,0x35	4,0x40	4,0x50	4,0x60	4,0x35	4,0x40	4,0x50	4,0x60
full nailing (fig.D1-5)	min of:				1,64	1,96	2,6	3,2
	3,1	3,7	4,94	6,14				
partial nailing (fig.D1-6)	3,2/k <sub>mod</sub>				0,13	0,16	0,22	0,27

2 ABR90 per connection	R <sub>4/5,k</sub>			
	connector nails according to ETA-04/0013			
	4,0x35	4,0x40	4,0x50	4,0x60
for full- and partial nailing (fig.D1-5 and D1-6)	$\max \left\{ \begin{array}{l} R_4^{1)} + R_5^{1)} \\ \min \left\{ \frac{2,17}{k_{mod}}; \frac{R_1}{2} \times \frac{b}{e} \right\} \end{array} \right.$			
	1) see table D1-9			

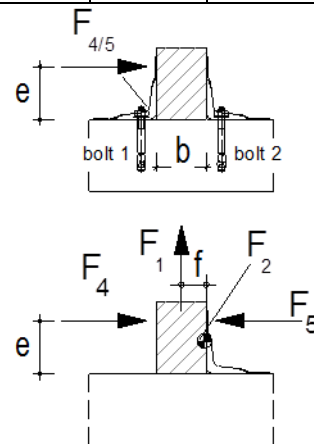

Connection with bolt

ABR90	connection with 2 angle brackets			
	for F <sub>1</sub>	for F <sub>2/3</sub>	for F <sub>4/5</sub> , bolt 1	for F <sub>4/5</sub> , bolt 2
k <sub>ax</sub>	0,50	-	0,50	0,10
k <sub>lat</sub>	-	0,50	-	1,00

For each bolt it's needed to check:  $R_{bolt,d,lateral} \geq k_{lat} \times F_{i,d}$  ;  $R_{bolt,d,axial} \geq k_{ax} \times F_{i,d}$ ; and also the combination

Table D1-9 1 Angle Bracket ABR90, beam to rigid support connection

1 ABR90 per connection	characteristic capacities [kN] per connection							
	R <sub>1,k</sub> *				R <sub>4,k</sub> *			
	connector nails according to ETA-04/0013							
	4,0x35 to 4,0x60				4,0x35 to 4,0x60			
	21,7/((f+78)/k <sub>mod</sub> )				21,7 / (e x k <sub>mod</sub> )			
	R <sub>2/3,k</sub>				R <sub>5,k</sub> *			
	connector nails according to ETA-04/0013							
	4,0x35	4,0x40	4,0x50	4,0x60	4,0x35	4,0x40	4,0x50	4,0x60
	half of the values for a connection with 2 ABR90, if the timber is prevented from rotation, otherwise R <sub>2/3</sub> =0,0kN				X1=			
					222	266	355	443
					X2=			
					107	128	171	213
	* for full- and partial nailing e is to insert in [mm]; e ≥ 10mm negative values shall not be considered				$\min\left(\frac{X1}{e-9,99mm}; \frac{X2}{85mm-e}; \frac{110}{e \times k_{mod}}\right)$			

Connection with bolt

ABR90	connection with 1 angle brackets			
	for F <sub>1</sub>	for F <sub>2/3</sub>	for F <sub>4</sub>	for F <sub>5</sub>
k <sub>ax</sub>	1,00	-	e/20	e/95
k <sub>lat</sub>	-	-	1,00	1,00

For each bolt it's needed to check:  $R_{bolt,d,lateral} \geq k_{lat} \times F_{i,d}$  ;  $R_{bolt,d,axial} \geq k_{ax} \times F_{i,d}$ ; and also the combination

**Annex D2 – AB90**

**Product Name:**

Product Name	Alternative name			
	UK	France	Denmark	Germany
AB90	--	E2/2.5/7091	--	90 o/R
AB90S	--	--	--	--
AB90S2				

**Drawing:**

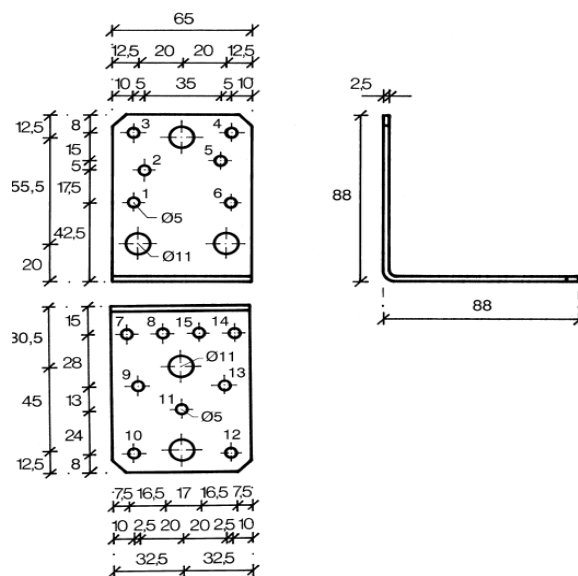

Figure D2-1 - AB 90

**Material:**

Standard material : S250GD + Z275 according to EN 10346

Or stainless steel according to clause II-1

**Nail pattern:**

Beam to beam connection

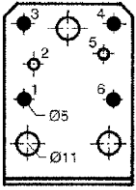

Figure D2-2  
Minimum nailing  
Nails in holes number  
1,3,4,6 / 7,10,12,14

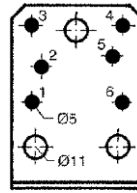
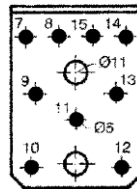

Figure D2-3  
Maximum nailing  
Nails in holes number  
1,2,3,4,5,6/  
7,8,9,10,11,12,13,14,15



Beam to column connection

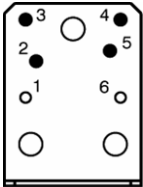
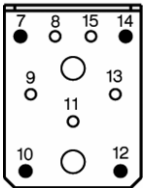

Figure D2-4  
Nailing  
Nails in holes number  
2,3,4,5 / 7,10,12,14



Trimmer connection

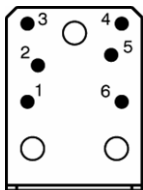
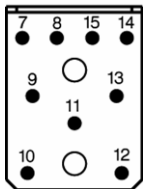

Figure D2-5  
Maximum Nailing  
Nails in holes number  
1,2,3,4,5,6 / 7,8,9,10,11,12,13,14,15



beam to rigid support connection

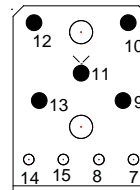
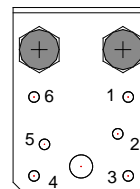

Figure D2-6  
Nailing  
nails in holes number  
9,10,11,12,13



and 2 bolts

**Modified characteristic capacities:**

Table D2-1 2 Angle Brackets AB90, beam to beam connection

2 Angle Brackets AB90 per connection					Modified characteristic capacity per connection (kN)		
Nailing	Load duration	$R_{1,k}$		$R_{2,k} = R_{3,k}$		$R_{4,k} = R_{5,k}$	
		Connector nail according to ETA-04/0013					
		4,0x40	4,0x60	4,0x40	4,0x60	4,0x40	4,0x60
<b>Minimum nailing: 4+4</b>  See fig. D2-2	P	2,2	3,1	3,3	4,4	$\frac{1,1 \cdot b + 38}{e - 2,5}$ max 4,4	$\frac{1,5 \cdot b + 41}{e - 2,5}$ max 4,9
	L	2,4	3,4	3,9	5,2	$\frac{1,2 \cdot b + 39}{e - 2,5}$ max 5,1	$\frac{1,7 \cdot b + 43}{e - 2,5}$ max 5,3
	M	2,7	3,8	4,5	5,9	$\frac{1,3 \cdot b + 40}{e - 2,5}$ max 5,7	$\frac{1,9 \cdot b + 44}{e - 2,5}$ max 5,7
	S	2,9	4,1	5,0	6,6	$\frac{1,4 \cdot b + 41}{e - 2,5}$ max 6,0	$\frac{2,1 \cdot b + 45}{e - 2,5}$ max 6,0
	I	3,3	4,8	6,1	8,1	$\frac{1,6 \cdot b + 42}{e - 2,5}$ max 6,7	$\frac{2,4 \cdot b + 48}{e - 2,5}$ max 6,7
<b>Maximum nailing: 6+9</b>  See fig. D2-3	P	3,5	5,2	4,3	6,3	$\frac{1,8 \cdot b + 43}{e - 2,5}$ max 4,9	$\frac{2,6 \cdot b + 49}{e - 2,5}$ max 4,9
	L	3,9	5,9	5,0	7,3	$\frac{2,0 \cdot b + 45}{e - 2,5}$ max 5,3	$\frac{3,0 \cdot b + 52}{e - 2,5}$ max 5,3
	M	4,4	6,6	5,8	8,4	$\frac{2,2 \cdot b + 46}{e - 2,5}$ max 5,7	$\frac{3,3 \cdot b + 55}{e - 2,5}$ max 5,7
	S	4,8	6,9	6,5	9,4	$\frac{2,4 \cdot b + 48}{e - 2,5}$ max 6,0	$\frac{3,5 \cdot b + 56}{e - 2,5}$ max 6,0
	I	5,6	6,9	7,9	11,5	$\frac{2,8 \cdot b + 51}{e - 2,5}$ max 6,7	$\frac{3,5 \cdot b + 56}{e - 2,5}$ max 6,7

b and e are in mm

Wane may not occur under the angle brackets.

Table D2-2 1 Angle Bracket AB90, beam to beam connection

1 Angle Bracket per connection		Modified characteristic capacity per connection (kN)						
Nailing	Load duration	$R_{1,k}$		$R_{2,k} = R_{3,k}$		$R_{4,k} = R_{5,k}$		
		Connector nail according to ETA-04/0013:						
		4,0x40	4,0x60	4,0x40	4,0x60	4,0x40	4,0x60	
Minimum nailing: <b>4+4</b>  (see fig. D2-2)	P	$f \leq 93$ : <u>26,6</u> f+43	$f \leq 14$ : <u>44,3</u> f+43	1,7	2,2	3,6	<u>20,8</u> e-2,5 max	5,2
		$f > 93$ : <u>20,8</u> f+13	$f > 14$ :					
	L	$f \leq 47$ : <u>31,1</u> f+43	$f \leq 7$ : <u>51,7</u> f+43	2,0	2,6	4,4	<u>20,8</u> e-2,5 max	6,2
		$f > 47$ : <u>20,8</u> f+13	$f > 7$ :					
	M	$f \leq 29$ : <u>35,5</u> f+43	$f \leq 3$ : <u>59</u> f+43	2,2	3,0	5,2	<u>20,8</u> e-2,5 max	7,1
		$f > 29$ : <u>20,8</u> f+13	$f > 3$ :					
	S	$f \leq 20$ : <u>40,0</u> f+43		2,5	3,3	5,9	<u>20,8</u> e-2,5 max	8,1
		$f > 20$ : <u>20,8</u> f+13	$f > 0$ :					
	I	$f \leq 9$ : <u>48,8</u> f+43		3,1	4,1	7,4	<u>20,8</u> e-2,5 max	10,0
		$f > 9$ : <u>20,8</u> f+13	$f > 0$ :					
	Maximum nailing: <b>6+9</b>  (see fig. D2-3)	P			2,2	3,1	9,7	<u>20,8</u> e-2,5 max 12,6
		L			2,5	3,7	11,3	<u>20,8</u> e-2,5 max 14,7
		M	<u>20,8</u> f+13		2,9	4,2	12,9	<u>20,8</u> e-2,5 max 16,8
		S			3,2	4,7	14,6	<u>20,8</u> e-2,5 max 19,0
		I			4,0	5,7	17,9	<u>20,8</u> e-2,5 max 23,2

e and f are in mm

Wane may not occur under the angle brackets.

Table D2-3 1 Angle Bracket AB90, beam to column connection

Beam to column connection 1 Angle Bracket AB90		Modified characteristic capacity per connection (kN)		
Nailing	Load duration	$R_{1,k}$		$R_{2,k}$
		Flap turned downwards	Flap turned upwards	
4,0x40/4,0x60 Beam: 4 Column: 4  See fig. D2-4	P	3,8	3,4	0,7
	L	4,5	3,6	
	M	4,7	3,8	
	S	4,9	3,9	
	I	5,3	4,2	

End gab: max. 5 mm

Table D2-4 2 Angle Brackets AB90, trimmer connection

Trimmer with 2 Angle Brackets AB90		Modified characteristic capacity per connection (kN)	
Nailing	Load duration	$R_{2,k} = R_{3,k}$	
		Connector nail according to ETA-04/0013:	
		4,0x40	4,0x60
Joist: 6 Header: 9  See fig. D2-5	P	4,3	6,2
	L	5,0	7,2
	M	5,8	8,2
	S	6,5	9,2
	I	7,9	11,5



Table D2-5 2 Angle Brackets AB90, beam to rigid support connection

2 AB90 per connection	modified characteristic capacities [kN] per connection					
	$R_{1,k}$		$R_{2/3,k}$			
	connector nails according to ETA-04/0013					
nailing	4,0x35 to 4,0x60		4,0x35	4,0x40	4,0x50	4,0x60
nailing (fig.D2-6)	$5,4/k_{mod}$		4,73	5,03	6,25	6,66
2 AB90 per connection	$R_{4/5,k}$					
	connector nails according to ETA-04/0013					
	4,0x35	4,0x40	4,0x50	4,0x60		
nailing (fig.D2-6)	$\max \left\{ \begin{array}{l} R_4^{1)} + R_5^{1)} \\ \min \left\{ \frac{4,5}{k_{mod}} ; \frac{R_1}{2} \times \frac{b}{e} \right\} \end{array} \right.$					
	1) see table D2-5					

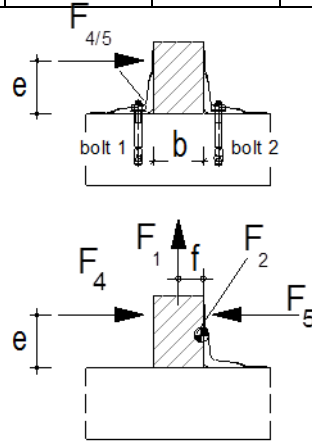

Connection with bolt

AB90	connection with 2 angle brackets			
factor:	for $F_1$	for $F_{2/3}$	for $F_{4/5, bolt 1}$	for $F_{4/5, bolt 2}$
$k_{ax}$	0,77	-	$1,53xe/b$	0,33
$k_{lat}$	-	see description	-	1,00

For each bolt group it's needed to check:  $R_{bolt,d,lateral} \geq k_{lat} \times F_{i,d}$  ;  $R_{bolt,d,axial} \geq k_{ax} \times F_{i,d}$  ; and also the combination

The connection with bolts has to be checked as following:

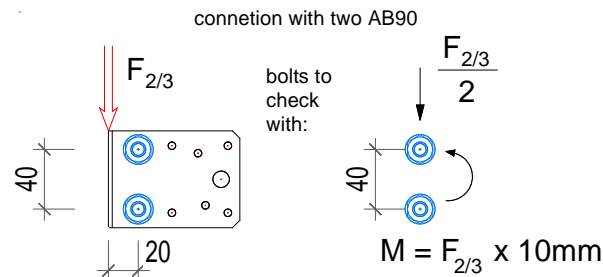

Table D2-5 1 Angle Brackets AB90, beam to rigid support connection

1 AB90 per connection	modified characteristic capacities [kN] per connection							
	$R_{1,k}$				$R_{4,k}$			
	connector nails according to ETA-04/0013							
	4,0x35 to 4,0x60				4,0x35 to 4,0x60			
	$19,9/((f+16)/k_{mod})$				$45,2 / (e \times k_{mod})$			
nailing (fig.D2-6)	$R_{2/3,k}$				$R_{5,k}$			
	connector nails according to ETA-04/0013							
	4,0x35	4,0x40	4,0x50	4,0x60	4,0x35	4,0x40	4,0x50	4,0x60
	half of the values for a connection with 2 AB105, if the timber is prevented from rotation, otherwise $R_{2/3}=0,0kN$				X1=			
123					148	197	246	
				X2=				
				63	75	100	125	
e is to insert in [mm]; $e \geq 10mm$ negativ values shall not be considered				$\min\left(\frac{X1}{e - 9,99mm}; \frac{X2}{85mm - e}; \frac{19,9}{e \times k_{mod}}\right)$				

## Connection with bolt

AB90	connection with 1 angle brackets			
factor:	for $F_1$	for $F_{2/3}$	for $F_4$	for $F_5$
$k_{ax}$	1,53	-	$e/30$	$e/26$
$k_{lat}$	-	see description	1,00	1,00

For each bolt group it's needed to check:  $R_{bolt,d,lateral} \geq k_{lat} \times F_{i,d}$  ;  $R_{bolt,d,axial} \geq k_{ax} \times F_{i,d}$  ; and also the combination

### Annex D3 – ABR105

**Product Name:**

Product Name	Alternative name			
	UK	France	Denmark	Germany
ABR105	ABR105-R	ABR105-R	--	105 m/R
ABR105S	--	E3IX	--	--
ABR105S2	--	--	--	--

+

**Drawing:**

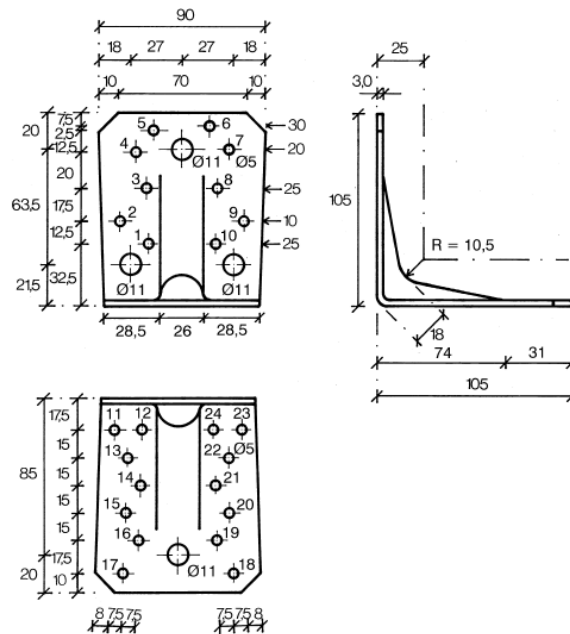

Figure D3-1 - ABR105

**Material:**

Standard material : S250GD + Z275 according to EN 10346  
 Or stainless steel according to clause II-1

**Nail pattern:**

Beam to beam connection

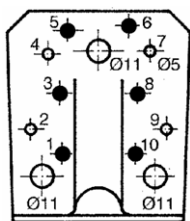

Figure D3-2  
Minimum nailing  
Nails in holes number  
1,3,5,6,8,10 / 11,12,17,18,23,24

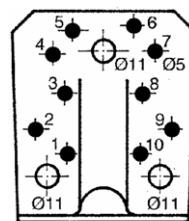
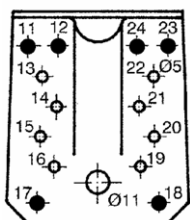
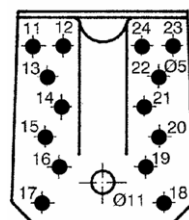

Figure D3-3  
Maximum nailing  
Nails in all holes



Beam to column connection

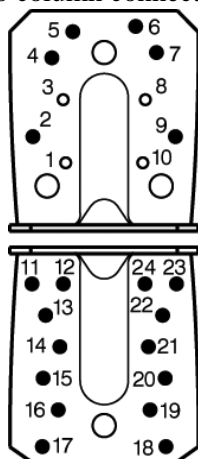

Figure D3-4  
Nailing  
Nails in holes number  
2,4,5,6,7,9 / 11 to 24

Beam to rigid support connection

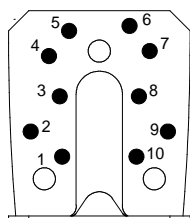
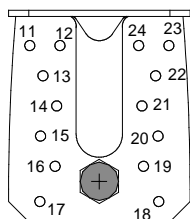

Figure D3-5  
Nailing  
nails in holes number  
1 to 10



and 1 bolt

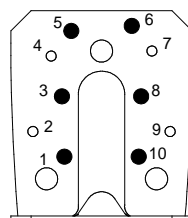
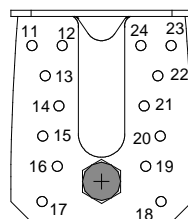

Figure D3-6  
Nailing  
nails in holes number  
1,3,5,6,8,10



and 1 bolt

**Modified characteristic capacities:**

Table D3-1 2 Angle Brackets ABR105, beam to beam connection

2 Angle Brackets ABR105 per connection				Modified characteristic capacity per connection (kN)				
Nailing	Load duration	R <sub>1,k</sub>		R <sub>2,k</sub> = R <sub>3,k</sub>		R <sub>4,k</sub> = R <sub>5,k</sub>		
		Connector nail according to ETA-04/0013						
		4,0x40	4,0x60	4,0x40	4,0x60	4,0x40	4,0x60	
<b>Minimum nailing: 6+6</b>  See fig. D3-2	P	3,6	5,9	4,6	7,0	$\frac{10,2 \cdot b + 601}{e - 10,7}$	$\frac{11,5 \cdot b + 599}{e - 10,7}$	
		3,6	5,9			max 6,8	max 9,0	
	L	4,1	6,9	5,4	8,1	$\frac{10,6 \cdot b + 601}{e - 10,7}$	$\frac{12,0 \cdot b + 598}{e - 10,7}$	
		4,1	6,9			max 7,3	max 10,0	
	M	4,7	7,9	6,2	9,3	$\frac{10,9 \cdot b + 600}{e - 10,7}$	$\frac{12,5 \cdot b + 597}{e - 10,7}$	
		4,7	7,9			max 7,9	max 10,9	
	S	5,3	8,9	6,9	10,5	$\frac{11,2 \cdot b + 599}{e - 10,7}$	$\frac{13,0 \cdot b + 596}{e - 10,7}$	
		5,3	8,9			max 8,5	max 11,9	
	I	6,5	10,8	8,5	12,8	$\frac{11,8 \cdot b + 598}{e - 10,7}$	$\frac{14,1 \cdot b + 595}{e - 10,7}$	
		6,5	10,4			max 9,6	max 13,7	
	<b>Maximum nailing: 10+14</b>  See fig. D3-3	P	6,5	10,7	8,7	12,2	$\frac{11,0 \cdot b + 568}{e - 10,7}$	$\frac{12,8 \cdot b + 562}{e - 10,7}$
			2,8	6,5			max 9,7	max 14,0
L		7,5	12,5	10,2	14,2	$\frac{11,5 \cdot b + 566}{e - 10,7}$	$\frac{13,5 \cdot b + 559}{e - 10,7}$	
		3,6	8,4			max 10,8	max 15,8	
M		8,6	14,3	11,6	16,2	$\frac{11,9 \cdot b + 565}{e - 10,7}$	$\frac{14,3 \cdot b + 557}{e - 10,7}$	
		4,5	10,6			max 11,9	max 17,5	
S		9,7	16,1	13,1	18,2	$\frac{12,4 \cdot b + 563}{e - 10,7}$	$\frac{15,0 \cdot b + 554}{e - 10,7}$	
		5,5	11,7			max 12,9	max 19,3	
I		11,9	19,7	16,0	22,3	$\frac{13,3 \cdot b + 560}{e - 10,7}$	$\frac{16,5 \cdot b + 549}{e - 10,7}$	
		7,7	13,8			max 15,1	max 22,8	

b and e are in mm.

■ When the purlin has a wane on the side towards the Angle Bracket with an extent from the bottom up to the lower nail the value in the grey square is valid.

Table D3-2 1 Angle Bracket ABR105, beam to beam connection

Load duration: P		1 Angle Bracket per connection		Modified characteristic capacity per connection (kN)			
$R_{1,k}$		$R_{2,k} = R_{3,k}$		$R_{4,k}$		$R_{5,k}$	
Connector nail according to ETA-04/0013:							
4,0x40	4,0x60	4,0x40	4,0x60	4,0x40	4,0x60	4,0x40	4,0x60
<b>Minimum nailing: 6+6 (see fig. D3-2)</b>							
$f \leq 25$ : $\frac{162}{f+60}$	$f \leq 35$ : $\frac{215}{f+60}$	2,3	3,5	$e < 37,5$ : $\frac{52}{37,5-e}$	$e < 37,5$ : $\frac{87}{37,5-e}$	$e \leq 76$ : $\frac{47}{85-e}$	$e \leq 74$ : $\frac{77}{85-e}$
				$e \leq 74$ : 2,2	$e \leq 76$ : 2,8	$76 < e \leq 1,89 \cdot b + 3$ :	$74 < e \leq 1,69 \cdot b + 8$ :
$f > 25$ : $\frac{47}{f}$	$f > 35$ : $\frac{77}{f}$	2,3	3,5	$74 < e \leq 127$ : $\frac{162}{e}$	$76 < e \leq 137$ : $\frac{215}{e}$	5,4	6,8
				$127 < e \leq 500$ : $\frac{47}{e-85}$	$137 < e \leq 500$ : $\frac{77}{e-85}$	$e > 1,89 \cdot b + 3$ :	$e > 1,69 \cdot b + 8$ : $\frac{10,2 \cdot b - 446}{e-85}$
<b>Maximum nailing: 10+14 (see fig. D3-3)</b>							
$f \leq 40$ : $\frac{188}{f+60}$	$f \leq 55$ : $\frac{259}{f+60}$	4,4	6,1	$e < 37,5$ : $\frac{92}{37,5-e}$	$e < 37,5$ : $\frac{153}{37,5-e}$	$e \leq 72$ : $\frac{82}{85-e}$	$e \leq 68$ : $\frac{137}{85-e}$
				$e \leq 29$ : 6,6	$e \leq 31$ : 8,5	$72 < e \leq 1,78 \cdot b + 2$ :	$68 < e \leq 1,59 \cdot b + 6$ :
$f > 40$ : $\frac{73}{f}$	$f > 55$ : $\frac{122}{f}$	4,4	6,1	$29 < e \leq 166$ : $\frac{190}{e}$	$31 < e \leq 187$ : $\frac{261}{e}$	6,2	8,1
				$166 < e \leq 500$ : $\frac{82}{e-85}$	$e > 187$ : $\frac{137}{e-85}$	$e > 1,78 \cdot b + 2$ : $\frac{11,0 \cdot b - 513}{e-85}$	$e > 1,59 \cdot b + 6$ : $\frac{12,8 \cdot b - 636}{e-85}$

b, e and f are in mm.

When the purlin has a wane on the side towards the Angle Bracket with an extent from the bottom up to the lower nail the formula in the grey square shall be checked additionally.



Table D3-4 1 Angle Bracket ABR105, beam to beam connection

Load duration: M		1 Angle Bracket per connection		Modified characteristic capacity per connection (kN)			
R <sub>1,k</sub>		R <sub>2,k</sub> = R <sub>3,k</sub>		R <sub>4,k</sub>		R <sub>5,k</sub>	
Connector nail according to ETA-04/0013:							
4,0x40	4,0x60	4,0x40	4,0x60	4,0x40	4,0x60	4,0x40	4,0x60
<b>Minimum nailing: 6+6 (see fig. D3-2)</b>							
f <sub>≤31</sub> : $\frac{118}{f+60}$	f <sub>≤42</sub> : $\frac{259}{f+60}$	3,1	4,7	e <sub>&lt;37,5</sub> : $\frac{70}{37,5-e}$	e <sub>&lt;37,5</sub> : $\frac{116}{37,5-e}$	e <sub>≤75</sub> : $\frac{62}{85-e}$	e <sub>≤72</sub> : $\frac{103}{85-e}$
						75<e <sub>≤1,77·b+6</sub> : 6,1	72<e <sub>≤1,57·b+11</sub> : 8,0
e <sub>≤64</sub> : 2,9	e <sub>≤69</sub> : 3,8						
64<e <sub>≤135</sub> : $\frac{188}{e}$	69<e <sub>≤146</sub> : $\frac{259}{e}$						
f <sub>&gt;31</sub> : $\frac{62}{f}$	f <sub>&gt;42</sub> : $\frac{103}{f}$			135<e <sub>≤500</sub> : $\frac{62}{e-85}$	146<e <sub>≤500</sub> : $\frac{103}{e-85}$	e <sub>&gt;1,77·b+6</sub> : $\frac{10,9·b-486}{e-85}$	e <sub>&gt;1,57·b+11</sub> : $\frac{12,5·b-591}{e-85}$
<b>Maximum nailing: 10+14 (see fig. D3-3)</b>							
f <sub>≤48</sub> : $\frac{224}{f+60}$	f <sub>≤65</sub> : $\frac{318}{f+60}$	5,8	8,1	e <sub>&lt;37,5</sub> : $\frac{123}{37,5-e}$	e <sub>&lt;37,5</sub> : $\frac{204}{37,5-e}$	e <sub>≤70</sub> : $\frac{110}{85-e}$	e <sub>≤66</sub> : $\frac{182}{85-e}$
						70<e <sub>≤1,67·b+4</sub> : 7,1	66<e <sub>≤1,48·b+8</sub> : 9,6
e <sub>≤26</sub> : 8,8	e <sub>≤28</sub> : 11,3						
26<e <sub>≤183</sub> : $\frac{226}{e}$	28<e <sub>≤104</sub> : $\frac{321}{e}$						
f <sub>&gt;48</sub> : $\frac{97}{f}$	f <sub>&gt;65</sub> : $\frac{162}{f}$			183<e <sub>≤500</sub> : $\frac{110}{e-85}$	104<e <sub>≤500</sub> : $\frac{245}{e-32,5}$	e <sub>&gt;1,67·b+4</sub> : $\frac{11,9·b-575}{e-85}$	e <sub>&gt;1,48·b+8</sub> : $\frac{14,3·b-739}{e-85}$

b, e and f are in mm.

■ When the purlin has a wane on the side towards the Angle Bracket with an extent from the bottom up to the lower nail the formula in the grey square shall be checked additionally.



Table D3-5 1 Angle Bracket ABR105, beam to beam connection

Load duration: S		1 Angle Bracket per connection		Modified characteristic capacity per connection (kN)			
R <sub>1,k</sub>		R <sub>2,k</sub> = R <sub>3,k</sub>		R <sub>4,k</sub>		R <sub>5,k</sub>	
Connector nail according to ETA-04/0013:							
4,0x40	4,0x60	4,0x40	4,0x60	4,0x40	4,0x60	4,0x40	4,0x60
<b>Minimum nailing: 6+6 (see fig. D3-2)</b>							
f≤33: $\frac{202}{f+60}$	f≤44: $\frac{281}{f+60}$	3,5	5,2	e<37,5: $\frac{78}{37,5-e}$	e<37,5: $\frac{130}{37,5-e}$	e≤74: $\frac{70}{85-e}$	e≤71: $\frac{116}{85-e}$
				e≤61: 3,3 $\frac{202}{e}$	e≤66: 4,2 $\frac{281}{e}$	74<e≤1,73·b+7: 6,5	71<e≤1,53·b+12: 8,5
f>33: $\frac{70}{f}$	f>44: $\frac{116}{f}$			139<e≤500: $\frac{70}{e-85}$	149<e≤500: $\frac{116}{e-85}$	e>1,73·b+7: $\frac{11,2·b-506}{e-85}$	e>1,53·b+12: $\frac{13,0·b-624}{e-85}$
<b>Maximum nailing: 10+14 (see fig. D3-3)</b>							
f≤52: $\frac{242}{f+60}$	f≤69: $\frac{348}{f+60}$	6,5	9,1	e<37,5: $\frac{138}{37,5-e}$	e<37,5: $\frac{230}{37,5-e}$	e≤69: $\frac{123}{85-e}$	e≤65: $\frac{205}{85-e}$
				e≤25: 9,9 $\frac{244}{e}$	e≤27: 12,9 $\frac{351}{e}$	69<e≤1,63·b+5: 7,6	65<e≤1,44·b+9: 10,4
f>52: $\frac{110}{f}$	f>69: $\frac{182}{f}$			195<e≤300: $\frac{245}{e-32,5}$	87<e≤500: $\frac{245}{e-32,5}$	e>1,63·b+5: $\frac{12,4·b-606}{e-85}$	e>1,44·b+9: $\frac{15,0·b-791}{e-85}$
				300<e≤500: $\frac{123}{e-85}$			

b, e and f are in mm.

■ When the purlin has a wane on the side towards the Angle Bracket with an extent from the bottom up to the lower nail the formula in the grey square shall be checked additionally.

Table D3-6 1 Angle Bracket ABR105, beam to beam connection

Load duration: I		1 Angle Bracket per connection		Modified characteristic capacity per connection (kN)			
$R_{1,k}$		$R_{2,k} = R_{3,k}$		$R_{4,k}$		$R_{5,k}$	
Connector nail according to ETA-04/0013:							
4,0x40	4,0x60	4,0x40	4,0x60	4,0x40	4,0x60	4,0x40	4,0x60
<b>Minimum nailing: 6+6 (see fig. D3-2)</b>							
f≤38: $\frac{228}{f+60}$	f≤49: $\frac{325}{f+60}$	4,2	6,4	e<37,5: $\frac{96}{37,5-e}$	e<37,5: $\frac{159}{37,5-e}$	e≤73: $\frac{85}{85-e}$	e≤70: $\frac{142}{85-e}$
				e≤57: 4	e≤63: 5,2	73<e≤1,65·b+9:	70<e≤1,45·b+14:
f>38: $\frac{85}{f}$	f>49: $\frac{142}{f}$	4,2	6,4	57<e≤145: $\frac{228}{e}$	63<e≤101: $\frac{325}{e}$	7,2	9,7
				145<e≤500: $\frac{85}{e-85}$	101<e≤190: $\frac{245}{e-32,5}$	e>1,65·b+9: $\frac{11,8·b-545}{e-85}$	e>1,45·b+14: $\frac{14,1·b-690}{e-85}$
					190<e≤500: $\frac{142}{e-85}$		
<b>Maximum nailing: 10+14 (see fig. D3-3)</b>							
f≤59: $\frac{277}{f+60}$	f≤76: $\frac{407}{f+60}$	8,0	11,2	e<37,5: $\frac{169}{37,5-e}$	e<37,5: $\frac{281}{37,5-e}$	e≤67: $\frac{151}{85-e}$	e≤64: $\frac{250}{85-e}$
				e≤23: 12,1	e≤26: 15,8	67<e≤1,55·b+7:	63<e≤1,37·b+11:
f>59: $\frac{134}{f}$	f>76: $\frac{223}{f}$	8,0	11,2	23<e≤110: $\frac{280}{e}$	26<e≤82: $\frac{407}{e}$	8,6	12,0
				110<e≤335: $\frac{245}{e-32,5}$	82<e≤500: $\frac{245}{e-32,5}$	e>1,55·b+7: $\frac{13,3·b-668}{e-85}$	e>1,37·b+11: $\frac{16,5·b-894}{e-85}$
				335<e≤500: $\frac{151}{e-85}$			

b, e and f are in mm.

■ When the purlin has a wane on the side towards the Angle Bracket with an extent from the bottom up to the lower nail the formula in the grey square shall be checked additionally.

Table D3-7 1 Angle Bracket ABR105, beam to column connection

Beam to column connection		Modified characteristic capacity per connection (kN)			
1 Angle Bracket ABR105		R <sub>1,k</sub>		R <sub>2,k</sub>	
Nailing	Load duration	Connector nail according to ETA-04/0013			
		4,0x40	4,0x60	4,0x40	4,0x60
Beam: 6 Column: 14  See fig. D3-4	P	9,6	10,2	0,9	1,5
	L	11,2	11,9	1,0	1,7
	M	12,8	13,6	1,2	2,0
	S	14,4	15,3	1,3	2,2
	I	17,6	18,7	1,6	2,7

End gab: max. 5 mm

Table D3-8 2 Angle Bracket ABR105, beam to rigid support connection

2 ABR105 per connection	modified characteristic capacities [kN] per connection							
	R <sub>1,k</sub>				R <sub>2/3,k</sub>			
nailing	connector nails according to ETA-04/0013							
	4,0x35	4,0x40	4,0x50	4,0x60	4,0x35	4,0x40	4,0x50	4,0x60
full nailing (fig. D3-5)	min of:				2,25	2,68	3,55	4,37
	4,08	4,88	6,48	8,08				
partial nailing (fig. D3-6)	7,7/k <sub>mod</sub>				1,6	1,9	2,52	3,09
	1,9	2,28	3,02	3,78				
2 ABR105 per connection	R <sub>4/5,k</sub> connector nails according to ETA-04/0013 4,0x35 to 4,0x60							
for full- and partial nailing (fig. D3-5 and D3-6)	$\max \left\{ \begin{array}{l} R_4^{1)} + R_5^{1)} \\ \min \left\{ \frac{4,6}{k_{mod}}; \frac{R_1}{2} \times \frac{b}{e} \right\} \end{array} \right.$							
	1) see table D3-9							

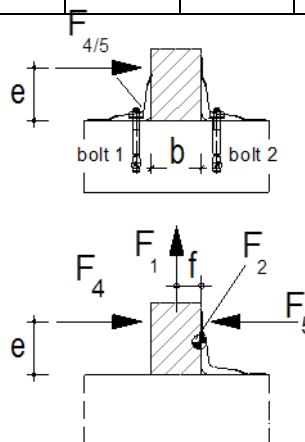

*Connection with bolt*

<b>ABR105</b>	connection with 2 angle brackets			
factor:	for F <sub>1</sub>	for F <sub>2/3</sub>	for F <sub>4/5</sub> , bolt 1	for F <sub>4/5</sub> , bolt 2
<b>k<sub>ax</sub></b>	0,50	-	e/b	0,13
<b>k<sub>lat</sub></b>	-	0,50	-	1,00

For each bolt it's needed to check:  $R_{\text{bolt,d,lateral}} \geq k_{\text{lat}} \times F_{i,d}$  ;  $R_{\text{bolt,d,axial}} \geq k_{\text{ax}} \times F_{i,d}$ ; and also the combination

Table D3-9 1 Angle Bracket ABR105, beam to rigid support connection

<b>1 ABR105 per connection</b>	modified characteristic capacities [kN] per connection							
	<b>R<sub>1,k</sub> *</b>				<b>R<sub>4,k</sub> *</b>			
	connector nails according to ETA-04/0013							
	4,0x35 to 4,0x60				4,0x35 to 4,0x60			
	45,8/((f+81)/k <sub>mod</sub> )				45,8 / (e x k <sub>mod</sub> )			
	<b>R<sub>2/3,k</sub></b>				<b>R<sub>5,k</sub> *</b>			
	connector nails according to ETA-04/0013							
	4,0x35	4,0x40	4,0x50	4,0x60	4,0x35	4,0x40	4,0x50	4,0x60
	half of the values for a connection with 2 ABR105, if the timber is prevented from rotation, otherwise R <sub>2/3</sub> =0,0kN				X1=			
					245	294	392	490
					X2=			
					173	208	277	347
	* for full- and partial nailing e is to insert in [mm]; e ≥ 10mm negativ values shall not be considered				$\min \left( \frac{X1}{e - 9,99\text{mm}} ; \frac{X2}{101\text{mm} - e} ; \frac{265}{e \times k_{\text{mod}}} \right)$			

*Connection with bolt*

<b>ABR105</b>	connection with 1 angle brackets			
factor:	for F <sub>1</sub>	for F <sub>2/3</sub>	for F <sub>4</sub>	for F <sub>5</sub>
<b>k<sub>ax</sub></b>	1,00	-	e/15	e/80
<b>k<sub>lat</sub></b>	-	-	1,00	1,00

For each bolt it's needed to check:  $R_{\text{bolt,d,lateral}} \geq k_{\text{lat}} \times F_{i,d}$  ;  $R_{\text{bolt,d,axial}} \geq k_{\text{ax}} \times F_{i,d}$ ; and also the combination

**Annex D4 – AB105**

**Product Name:**

Product Name	Alternative name			
	UK	France	Denmark	Germany
AB105	--	AB105-R	--	105 o/R
AB105S	--	--	--	--
AB105S2	--	--	--	--

**Drawing:**

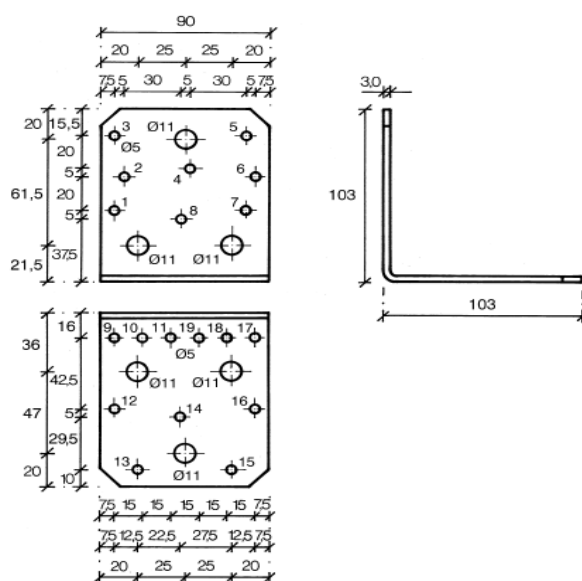

Figure D4-1 - AB105

**Material:**

Standard material : S250GD + Z275 according to EN 10346  
 Or stainless steel according to clause II-1

**Nail pattern:**

Beam to beam connection

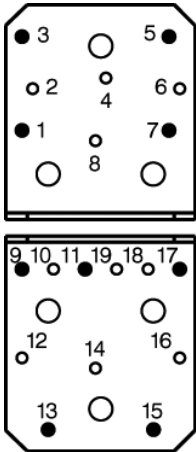

Figure D4-2  
Minimum nailing  
Nails in holes number  
1,3,5,7 / 9,11,13,15,19

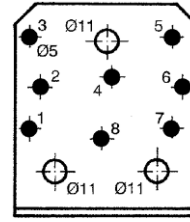

Figure D4-3  
Maximum nailing  
Nails in all holes

Beam to column connection

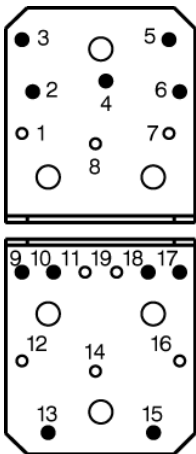

Figure D4-4  
Nailing  
Nails in holes number  
2,3,4,5,6 / 9,10,13,15,17,18

Trimmer connection

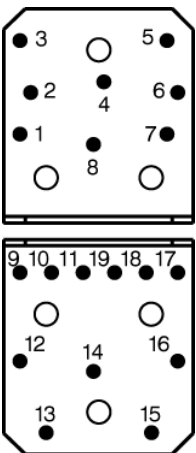

Figure D4-5  
Nailing  
Nails in all holes

beam to rigid support connection

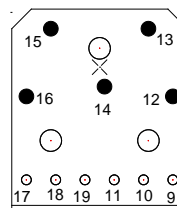
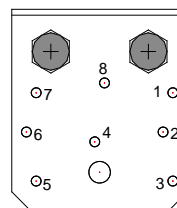

Figure D4-6  
Nailing  
nails in holes number  
12,13,14,15,16



and 2 bolts

**Modified characteristic capacities:**

Table D4-1 2 Angle Brackets AB105, beam to beam connection

2 Angle Brackets AB105 per connection				Modified characteristic capacity per connection (kN)			
Nailing	Load duration	$R_{1,k}$		$R_{2,k} = R_{3,k}$		$R_{4,k} = R_{5,k}$	
		Connector nail according to ETA-04/0013:					
		4,0x40	4,0x60	4,0x40	4,0x60	4,0x40	4,0x60
<b>Minimum nailing: 4+5</b>  See fig. D4-2	P	3,6	5,1	2,4	4,5	$\frac{1,9 \cdot b + 75}{e - 2,5}$ max 5,5	$\frac{2,6 \cdot b + 80}{e - 2,5}$ max 7,1
	L	4,1	5,7	2,8	5,3	$\frac{2,0 \cdot b + 76}{e - 2,5}$ max 6,4	$\frac{2,9 \cdot b + 83}{e - 2,5}$ max 8,3
	M	4,4	6,3	3,2	6,1	$\frac{2,2 \cdot b + 77}{e - 2,5}$ max 7,3	$\frac{3,2 \cdot b + 85}{e - 2,5}$ max 9,4
	S	4,8	6,9	3,6	6,8	$\frac{2,4 \cdot b + 79}{e - 2,5}$ max 8,2	$\frac{3,4 \cdot b + 87}{e - 2,5}$ max 10,3
	I	5,5	8,1	4,5	8,3	$\frac{2,7 \cdot b + 82}{e - 2,5}$ max 10,1	$\frac{4,0 \cdot b + 92}{e - 2,5}$ max 11,4
<b>Maximum nailing: 8+11</b>  See fig. D4-3	P	5,8	8,7	8,0	10,9	$\frac{2,9 \cdot b + 83}{e - 2,5}$ max 8,4	$\frac{4,3 \cdot b + 94}{e - 2,5}$ max 8,4
	L	6,6	9,8	9,3	12,7	$\frac{3,3 \cdot b + 86}{e - 2,5}$ max 9,1	$\frac{4,9 \cdot b + 99}{e - 2,5}$ max 9,1
	M	7,3	11,0	10,6	14,6	$\frac{3,6 \cdot b + 89}{e - 2,5}$ max 9,7	$\frac{5,5 \cdot b + 104}{e - 2,5}$ max 9,7
	S	8,0	12,2	12,0	16,4	$\frac{4,0 \cdot b + 92}{e - 2,5}$ max 10,3	$\frac{6,1 \cdot b + 108}{e - 2,5}$ max 10,3
	I	9,4	13,6	14,6	20,0	$\frac{4,7 \cdot b + 97}{e - 2,5}$ max 11,4	$\frac{6,8 \cdot b + 114}{e - 2,5}$ max 11,4

b and e are in mm

Wane may not occur under the angle brackets.

Table D4-2 1 Angle Bracket AB105, beam to beam connection

1 Angle Bracket per connection		Modified characteristic capacity per connection (kN)					
Nailing	Load duration	R <sub>1,k</sub>		R <sub>2,k</sub> = R <sub>3,k</sub>		R <sub>4,k</sub> = R <sub>5,k</sub>	
		Connector nail according to ETA-04/0013:					
		4,0x40	4,0x60	4,0x40	4,0x60	4,0x40	4,0x60
<b>Minimum nailing: 4+5</b> (See fig. D4-2)	P	f ≤ 80: 59 f+58	f ≤ 17: 97 f+58	1,2	2,3	5,2	<u>39,9</u> e-3,0 max
		f > 80: 40 f+14	f > 17:				6,9
	L	f ≤ 48: 68 f+58	f ≤ 10: 114 f+58	1,4	2,7	6,1	<u>39,9</u> e-3,0 max
		f > 48: 40 f+14	f > 10:				8,1
	M	f ≤ 32: 78 f+58	f ≤ 6: 130 f+58	1,6	3,0	7,1	<u>39,9</u> e-3,0 max
f > 32: 40 f+14		f > 6:	9,3				
S	f ≤ 23: 88 f+58	f ≤ 3: 146 f+58	1,8	3,4	8,0	<u>39,9</u> e-3,0 max	
	f > 23: 40 f+14	f > 3:				10,5	
I	f ≤ 12: 107 f+58		2,2	4,2	9,8	<u>39,9</u> e-3,0 max	
	f > 12: 40 f+14	f > 0:				12,8	
<b>Maximum nailing: 8+11</b> (See fig. D4-3)	P	<div style="border: 1px solid black; display: inline-block; padding: 5px;">           39,9 f+14         </div>		4,0	5,5	12,0	<u>39,9</u> e-3,0 max 15,5
	L			4,7	6,4	14,0	<u>39,9</u> e-3,0 max 18,1
	M			5,3	7,3	16,0	<u>39,9</u> e-3,0 max 20,7
	S			6,0	8,2	18,0	<u>39,9</u> e-3,0 max 23,3
	I			7,3	10,0	22,1	<u>39,9</u> e-3,0 max 28,5

e and f are in mm

f+14

Wane may not occur under the angle brackets



Table D4-3 1 Angle Bracket AB105, beam to column connection

Beam to column connection 1 Angle Bracket AB105		Modified characteristic capacity per connection (kN)		
Nailing	Load duration	R <sub>1,k</sub>		R <sub>2,k</sub>
		Flap turned downwards	Flap turned upwards	
CNA4,0x40 Beam: 5 Column: 6  See fig. D4-4	P	6,0	6,9	1,4
	L	7,0	7,3	
	M	8,1	7,6	
	S	9,1	7,9	
	I	9,8	8,4	
CNA4,0x60 Beam: 5 Column: 6  See fig. D4-4	P	7,7	6,9	1,4
	L	8,2	7,3	
	M	8,6	7,6	
	S	9,1	7,9	
	I	9,8	8,4	

End gab: max. 5 mm

Table D4-4 2 Angle Brackets AB105, trimmer connection

Trimmer with 2 Angle Brackets AB105		Modified characteristic capacity per connection (kN)	
Nailing	Load duration	R <sub>2,k</sub> = R <sub>3,k</sub>	
		Connector nail according to ETA-04/0013	
		4,0x40	4,0x60
Joist: 8 Header: 11  See fig. D4-5	P	8,0	10,9
	L	9,3	12,7
	M	10,6	14,6
	S	12,0	16,4
	I	14,6	20,0

Table D4-5 2 Angle Brackets AB105, beam to rigid support connection

2 AB105 per connection	modified characteristic capacities [kN] per connection							
	$R_{1,k}$				$R_{2/3,k}$			
	connector nails according to ETA-04/0013							
nailing	4,0x35	4,0x40	4,0x50	4,0x60	4,0x35	4,0x40	4,0x50	4,0x60
nailing (fig.D4-6)	min of:				4,86	5,18	6,43	6,85
	12,3	13,76	17,58	19,76				
	$11,3/k_{mod}$							

The connection with the bolts has to be checked as following:

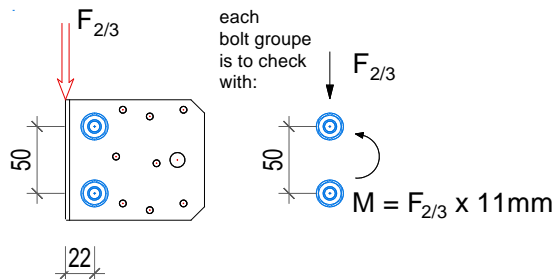
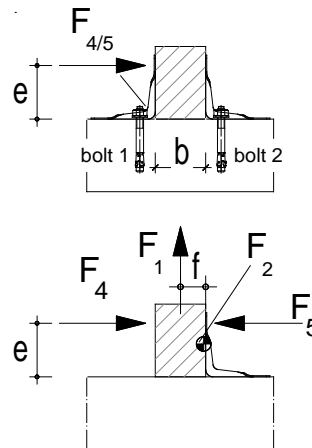

Table D4-6 2 Angle Brackets AB105, beam to rigid support connection

2 AB105 per connection	$R_{4/5,k}$ connector nails according to ETA-04/0013 4,0x35 to 4,0x60
nailing (fig.D4-6)	$\max \left\{ \begin{array}{l} R_4^{1)} + R_5^{1)} \\ \min \left\{ \frac{2,0}{k_{mod}} ; \frac{R_1}{2} \times \frac{b}{e} \right\} \end{array} \right.$
	<sup>1)</sup> see table D4-7



Connection with bolt

AB105	connection with 2 angle brackets			
factor:	for $F_1$	for $F_{2/3}$	for $F_{4/5}$ , bolt 1	for $F_{4/5}$ , bolt 2
$k_{ax}$	0,79	-	$1,58 \times e/b$	0,47
$k_{lat}$	-	see description	-	1,00

For each bolt group it's needed to check:  $R_{bolt,d,lateral} \geq k_{lat} \times F_{i,d}$  ;  $R_{bolt,d,axial} \geq k_{ax} \times F_{i,d}$  ; and also the combination

Table D4-7 1 Angle Brackets AB105, beam to rigid support connection

1 AB105 per connection	modified characteristic capacities [kN] per connection							
	R <sub>1,k</sub>				R <sub>4,k</sub>			
	connector nails according to ETA-04/0013							
	4,0x35 to 4,0x60				4,0x35 to 4,0x60			
	45,2/((f+18)/k <sub>mod</sub> )				19,9 / (e x k <sub>mod</sub> )			
nailing (fig.D4-6)	R <sub>2/3,k</sub>				R <sub>5,k</sub>			
	connector nails according to ETA-04/0013							
	4,0x35	4,0x40	4,0x50	4,0x60	4,0x35	4,0x40	4,0x50	4,0x60
	half of the values for a connection with 2 AB105, if the timber is prevented from rotation, otherwise R <sub>2/3</sub> =0,0kN				X1=			
				158	190	253	316	
				X2=				
				123	148	197	246	
e is to insert in [mm]; e ≥ 10mm negativ values shall not be considered								$\min\left(\frac{X1}{e - 9,99mm}; \frac{X2}{101mm - e}; \frac{45,2}{e \times k_{mod}}\right)$

Connection with bolt

AB105	connection with 1 angle brackets			
factor:	for F <sub>1</sub>	for F <sub>2/3</sub>	for F <sub>4</sub>	for F <sub>5</sub>
k <sub>ax</sub>	1,58	0,00	e / 21	e / 28
k <sub>lat</sub>	-	see description	1,00	1,00

For each bolt group it's needed to check: R<sub>bolt,d,lateral</sub> ≥ k<sub>lat</sub> x F<sub>i,d</sub> ; R<sub>bolt,d,axial</sub> ≥ k<sub>ax</sub> x F<sub>i,d</sub> ; and also the combination

**Annex D5 – ABR70**

**Product Name:**

Product Name	Alternative name			
	UK	France	Denmark	Germany
ABR70	--	EB/7070	--	70 m/R
ABR70S	--	--	--	--

**Drawing:**

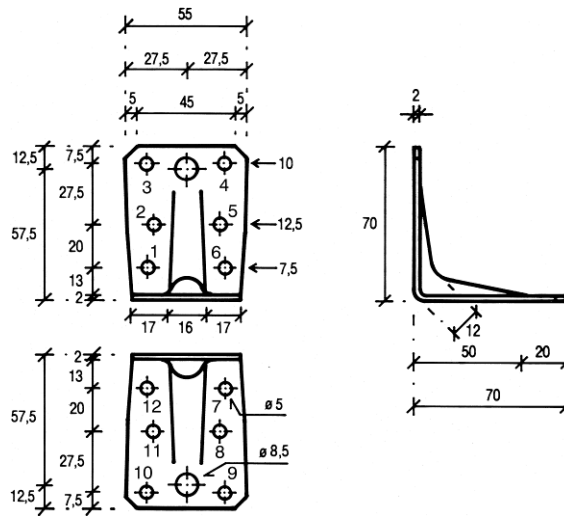

Figure D5-1 - ABR70

**Material:**

Standard material : S250GD + Z275 according to EN 10346

Or stainless steel according to clause II-1

**Nail pattern:**

Beam to beam connection

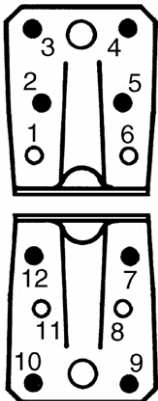

Figure D5-2  
Minimum nailing  
Nails in holes number  
2,3,4,5 / 7,9,10,12

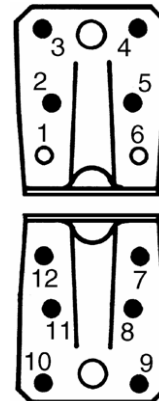

Figure D5-3  
Maximum nailing  
Nails in holes number  
2,3,4,5 / 7,8,9,10,11,12

**Modified characteristic capacities:**

Table D5-1 2 Angle Brackets ABR70, beam to beam connection

2 Angle Brackets ABR70 per connection				Modified characteristic capacity per connection (kN)			
Nailing	Load duration	$R_{1,k}$		$R_{2,k} = R_{3,k}$		$R_{4,k} = R_{5,k}$	
		Connector nail according to ETA-04/0013					
		4,0x40	4,0x60	4,0x40	4,0x60	4,0x40	4,0x60
<b>Minimum nailing: 4+4</b>  (See fig. D5-2)	P	2,1	3,0	2,9	4,1	$\frac{1,04 \cdot b + 155}{e}$	$\frac{1,48 \cdot b + 161}{e}$
		2,1	3,0			max 3,5	max 5,0
	L	2,4	3,4	3,4	4,8	$\frac{1,18 \cdot b + 157}{e}$	$\frac{1,72 \cdot b + 165}{e}$
		2,4	3,4			max 4,0	max 5,9
	M	2,4	3,9	3,9	5,5	$\frac{1,18 \cdot b + 157}{e}$	$\frac{1,97 \cdot b + 169}{e}$
		2,4	3,9			max 4,0	max 6,7
	S	2,7	4,4	4,4	6,2	$\frac{1,33 \cdot b + 159}{e}$	$\frac{2,21 \cdot b + 172}{e}$
		2,7	4,3			max 4,5	max 7,5
	I	3,3	5,4	5,3	7,5	$\frac{1,63 \cdot b + 164}{e}$	$\frac{2,71 \cdot b + 180}{e}$
		3,3	5,1			max 5,5	max 9,2
<b>Maximum nailing: 4+6</b>  (See fig. D5-3)	P	3,2	5,3	3,0	4,4	$\frac{1,60 \cdot b + 179}{e}$	$\frac{2,66 \cdot b + 206}{e}$
		2,5	4,1			max 6,0	max 9,9
	L	3,7	6,2	3,5	5,1	$\frac{1,86 \cdot b + 186}{e}$	$\frac{3,10 \cdot b + 217}{e}$
		3,1	4,6			max 7,0	max 11,6
	M	4,3	7,1	4,0	5,8	$\frac{2,13 \cdot b + 192}{e}$	$\frac{3,54 \cdot b + 228}{e}$
		3,4	5,2			max 8,0	max 13,2
	S	4,8	8,0	4,5	6,6	$\frac{2,40 \cdot b + 199}{e}$	$\frac{3,99 \cdot b + 239}{e}$
		3,7	5,8			max 9,0	max 14,9
	I	5,9	9,7	5,5	8,0	$\frac{2,93 \cdot b + 212}{e}$	$\frac{4,87 \cdot b + 261}{e}$
		4,4	6,9			max 10,9	max 18,2

b and e are in mm.

■ When the purlin has a wane on the side towards the Angle Bracket with an extent from the bottom up to the lower nail the formula in the gray square shall be checked additionally.

Table D5-2 1 Angle Bracket ABR70, beam to beam connection

Load duration: P		1 Angle Bracket per connection		Modified characteristic capacity per connection (kN)			
R <sub>1,k</sub>		R <sub>2,k</sub> = R <sub>3,k</sub>		R <sub>4,k</sub>		R <sub>5,k</sub>	
Connector nail according to ETA-04/0013							
4,0x40	4,0x60	4,0x40	4,0x60	4,0x40	4,0x60	4,0x40	4,0x60
<b>Minimum nailing: 4+4 (see fig. D5-2)</b>							
f <sub>≤</sub> 26: <u>54</u> f+62,5	f <sub>≤</sub> 24: <u>76</u> f+62,5	1,5	2,1	e<40: <u>28,5</u> 40-e	e<40: <u>40,6</u> 40-e	Min: <u>21</u> 55-e	Min: <u>30</u> 55-e
				e <sub>≤</sub> 26: 2,2	e <sub>≤</sub> 27: 2,8		
f>26: <u>15,5</u> f	f>24: <u>21</u> f	1,5	2,1	26<e <sub>≤</sub> 53: <u>54</u> e	27<e <sub>≤</sub> 48: <u>76</u> e	1,5	2,1
				e>53: <u>21</u> e-35	e>48: <u>21</u> e-35		
<b>Maximum nailing: 4+6 (see fig. D5-3)</b>							
f <sub>≤</sub> 16: <u>66</u> f+62,5	f <sub>≤</sub> 15: <u>109</u> f+62,5	1,5	2,2	e<40: <u>24,4</u> 40-e	e<40: <u>40,6</u> 40-e	Min: <u>18</u> 55-e	Min: <u>30</u> 55-e
				e <sub>≤</sub> 29: 2,2	e <sub>≤</sub> 28: 2,8		
f>16: <u>13,3</u> f	f>15: <u>21</u> f	1,5	2,2	29<e <sub>≤</sub> 52: <u>64</u> e	28<e <sub>≤</sub> 48: <u>79</u> e	1,5	2,5
				e>52: <u>21</u> e-35	e>48: <u>21</u> e-35		
<b>Maximum nailing: 4+6 (see fig. D5-3)</b>							
<b>Maximum nailing: 4+6 (see fig. D5-3)</b>							
f <sub>≤</sub> 16: <u>66</u> f+62,5	f <sub>≤</sub> 15: <u>109</u> f+62,5	1,5	2,2	e<40: <u>24,4</u> 40-e	e<40: <u>40,6</u> 40-e	Min: <u>18</u> 55-e	Min: <u>30</u> 55-e
				e <sub>≤</sub> 29: 2,2	e <sub>≤</sub> 28: 2,8		
f>16: <u>13,3</u> f	f>15: <u>21</u> f	1,5	2,2	29<e <sub>≤</sub> 52: <u>64</u> e	28<e <sub>≤</sub> 48: <u>79</u> e	1,5	2,5
				e>52: <u>21</u> e-35	e>48: <u>21</u> e-35		

b, e and f are in mm.

Table D5-3 1 Angle Bracket ABR70, beam to beam connection

Load duration: L		1 Angle Bracket per connection				Modified characteristic capacity per connection (kN)			
$R_{1,k}$		$R_{2,k} = R_{3,k}$		$R_{4,k}$		$R_{5,k}$			
Connector nail according to ETA-04/0013									
4,0x40	4,0x60	4,0x40	4,0x60	4,0x40	4,0x60	4,0x40	4,0x60		
<b>Minimum nailing: 4+4 (see fig. D5-2)</b>									
$f \leq 26$ : <u>61</u> f+62,5	$f \leq 19$ : <u>89</u> f+62,5	1,7	2,4	$e < 40$ : <u>32,6</u> 40-e	$e < 40$ : <u>47,4</u> 40-e	Min: <u>24</u> 55-e	Min: <u>34</u> 55-e		
				$e \leq 24$ : 2,6 24 < e ≤ 49: <u>61</u> e	$e \leq 24$ : 3,3 24 < e ≤ 48: <u>79</u> e			1,7	2,4
$f > 26$ : <u>17,8</u> f	$f > 19$ : <u>21</u> f			$e > 49$ : <u>21</u> e-35	$e > 48$ : <u>21</u> e-35	<u>1,2·b+12</u> e	<u>1,7·b+17</u> e		
<b>Maximum nailing: 4+6 (see fig. D5-3)</b>									
$f \leq 16$ : <u>77</u> f+62,5	$f \leq 12$ : <u>127</u> f+62,5	1,7	2,6	$e < 40$ : <u>28,5</u> 40-e	$e < 40$ : <u>47,4</u> 40-e	Min: <u>21</u> 55-e	Min: <u>34</u> 55-e		
				$e \leq 29$ : 2,6 29 < e ≤ 49: <u>74</u> e	$e \leq 24$ : 3,3 24 < e ≤ 48: <u>79</u> e			1,8	3,0
$f > 16$ : <u>15,5</u> f	$f > 12$ : <u>21</u> f			$e > 49$ : <u>21</u> e-35	$e > 48$ : <u>21</u> e-35	<u>1,9·b+37</u> e	<u>3,1·b+62</u> e		

b, e and f are in mm.

Table D5-4 1 Angle Bracket ABR70, beam to beam connection

Load duration: M		1 Angle Bracket per connection				Modified characteristic capacity per connection (kN)			
R <sub>1,k</sub>		R <sub>2,k</sub> = R <sub>3,k</sub>		R <sub>4,k</sub>		R <sub>5,k</sub>			
Connector nail according to ETA-04/0013									
4,0x40	4,0x60	4,0x40	4,0x60	4,0x40	4,0x60	4,0x40	4,0x60		
<b>Minimum nailing: 4+4 (see fig. D5-2)</b>									
f ≤ 26: <u>61</u> f+62,5	f ≤ 16: <u>102</u> f+62,5	1,9	2,7	e < 40: <u>32,6</u> 40-e	e < 40: <u>54,1</u> 40-e	Min: <u>24</u> 55-e	Min: <u>39</u> 55-e		
				e ≤ 21: 2,9	e ≤ 21: 3,8				
f > 26: <u>17,8</u> f	f > 16: <u>21</u> f			21 < e ≤ 48: <u>61</u> e	21 < e ≤ 48: <u>79</u> e	1,7	2,8		
				e > 48: <u>21</u> e-35	e > 48: <u>21</u> e-35			<u>1,2·b+12</u> e	<u>2,0·b+20</u> e
<b>Maximum nailing: 4+6 (see fig. D5-3)</b>									
f ≤ 16: <u>88</u> f+62,5	f ≤ 11: <u>146</u> f+62,5	2	2,9	e < 40: <u>32,6</u> 40-e	e < 40: <u>54,1</u> 40-e	Min: <u>24</u> 55-e	Min: <u>39</u> 55-e		
				e ≤ 27: 2,9	e ≤ 21: 3,8				
f > 16: <u>17,8</u> f	f > 11: <u>21</u> f			27 < e ≤ 48: <u>79</u> e	21 < e ≤ 48: <u>79</u> e	2	3,4		
				e > 48: <u>21</u> e-35	e > 48: <u>21</u> e-35			<u>2,1·b+43</u> e	<u>3,5·b+71</u> e

b, e and f are in mm.



Table D5-5 1 Angle Bracket ABR70, beam to beam connection

Load duration: S		1 Angle Bracket per connection		Modified characteristic capacity per connection (kN)			
R <sub>1,k</sub>		R <sub>2,k</sub> = R <sub>3,k</sub>		R <sub>4,k</sub>		R <sub>5,k</sub>	
Connector nail according to ETA-04/0013							
4,0x40	4,0x60	4,0x40	4,0x60	4,0x40	4,0x60	4,0x40	4,0x60
<b>Minimum nailing: 4+4 (see fig. D5-2)</b>							
f ≤ 26: $\frac{69}{f+62,5}$	f ≤ 14: $\frac{115}{f+62,5}$	2,2	3,1	e < 40: $\frac{36,6}{40-e}$	e < 40: $\frac{60,9}{40-e}$	Min: $\frac{27}{55-e}$	Min: $\frac{44}{55-e}$
				e ≤ 21: 3,3	e ≤ 19: 4,2	1,9	3,1
f > 26: $\frac{20}{f}$	f > 14: $\frac{21}{f}$			21 < e ≤ 48: $\frac{69}{e}$	19 < e ≤ 48: $\frac{79}{e}$		
				e > 48: $\frac{21}{e-35}$	e > 48: $\frac{21}{e-35}$		
<b>Maximum nailing: 4+6 (see fig. D5-3)</b>							
f ≤ 16: $\frac{99}{f+62,5}$	f ≤ 9: $\frac{164}{f+62,5}$	2,2	3,3	e < 40: $\frac{36,6}{40-e}$	e < 40: $\frac{60,9}{40-e}$	Min: $\frac{27}{55-e}$	Min: $\frac{44}{55-e}$
				e ≤ 24: 3,3	e ≤ 19: 4,2	2,3	3,8
f > 16: $\frac{20}{f}$	f > 9: $\frac{21}{f}$			24 < e ≤ 48: $\frac{79}{e}$	19 < e ≤ 48: $\frac{79}{e}$		
				e > 48: $\frac{21}{e-35}$	e > 48: $\frac{21}{e-35}$		

b, e and f are in mm.

Table D5-6 1 Angle Bracket ABR70, beam to beam connection

Load duration: I		1 Angle Bracket per connection				Modified characteristic capacity per connection (kN)			
R <sub>1,k</sub>		R <sub>2,k</sub> = R <sub>3,k</sub>		R <sub>4,k</sub>		R <sub>5,k</sub>			
Connector nail according to ETA-04/0013									
4,0x40	4,0x60	4,0x40	4,0x60	4,0x40	4,0x60	4,0x40	4,0x60		
<b>Minimum nailing: 4+4 (see fig. D5-2)</b>									
f ≤ 21: <u>84</u> f+62,5	f ≤ 11: <u>139</u> f+62,5	2,7	3,8	e < 40: <u>44,8</u> 40-e	e < 40: <u>74,4</u> 40-e	Min: <u>33</u> 55-e	Min: <u>54</u> 55-e		
				e ≤ 20: 4,0	e ≤ 15: 5,2				
f > 21: <u>21</u> f	f > 11: <u>21</u> f			20 < e ≤ 48: <u>79</u> e	15 < e ≤ 48: <u>79</u> e	2,3	3,8		
				e > 48: <u>21</u> e-35	e > 48: <u>21</u> e-35			<u>1,6·b+16</u> e	<u>2,7·b+27</u> e
<b>Maximum nailing: 4+6 (see fig. D5-3)</b>									
f ≤ 13: <u>120</u> f+62,5	f ≤ 7: <u>199</u> f+62,5	2,7	4,0	e < 40: <u>44,8</u> 40-e	e < 40: <u>74,4</u> 40-e	Min: <u>33</u> 55-e	Min: <u>54</u> 55-e		
				e ≤ 20: 4,0	e ≤ 15: 5,2				
f > 13: <u>21</u> f	f > 7: <u>21</u> f			20 < e ≤ 48: <u>79</u> e	15 < e ≤ 48: <u>79</u> e	2,8	4,7		
				e > 48: <u>21</u> e-35	e > 48: <u>21</u> e-35			<u>2,9·b+59</u> e	<u>4,9·b+97</u> e

b, e and f are in mm.

**Annex D6 – AB70**

**Product Name:**

Product Name	Alternative name			
	UK	France	Denmark	Germany
AB70	--	--	--	70 0/R
AB70S	--	--	--	--
AB70S2	--	--	--	--

**Drawing:**

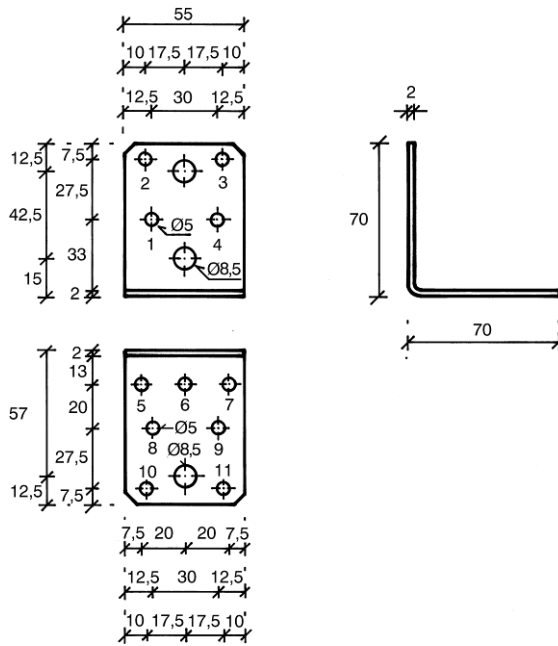

Figure D6-1 - AB70

**Material:**

Standard material : S250GD + Z275 according to EN 10346  
 Or stainless steel according to clause II-1

**Nail pattern:**

Beam to beam connection

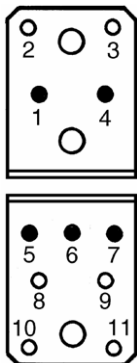

Figure D6-2  
 Minimum nailing  
 Nails in holes number  
 1,4 / 5,6,7

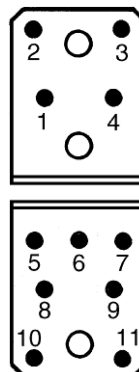

Figure D6-3  
 Maximum nailing  
 Nails in all holes

**Modified characteristic capacities:**

Table D6-1 2 Angle Brackets AB70, beam to beam connection

2 Angel Brackets AB70 per connection					Modified characteristic capacity per connection (kN)			
Nailing	Load duration	R <sub>1,k</sub>		R <sub>2,k</sub> = R <sub>3,k</sub>		R <sub>4,k</sub> = R <sub>5,k</sub>		
		Connector nail according to ETA-04/0013						
		4,0x40	4,0x60	4,0x40	4,0x60	4,0x40	4,0x60	
<b>Minimum nailing: 2+3</b> (See fig. D6-2)	P	2,7	4,0	2,3	3,4	$\frac{1,33 \cdot b + 26}{e-2}$ max 3,3	$\frac{1,98 \cdot b + 30}{e-2}$ max 3,5	
	L	3,0	4,5	2,7	3,9	$\frac{1,50 \cdot b + 27}{e-2}$ max 3,8	$\frac{2,25 \cdot b + 32}{e-2}$ max 3,8	
	M	3,3	4,7	3,1	4,5	$\frac{1,66 \cdot b + 28}{e-2}$ max 3,8	$\frac{2,34 \cdot b + 33}{e-2}$ max 4,0	
	S	3,6	4,7	3,5	5,1	$\frac{1,82 \cdot b + 29}{e-2}$ max 4,3	$\frac{2,34 \cdot b + 33}{e-2}$ max 4,3	
	I	4,3	4,7	4,2	6,2	$\frac{2,14 \cdot b + 31}{e-2}$ max 4,7	$\frac{2,34 \cdot b + 33}{e-2}$ max 4,7	
<b>Maximum nailing: 4+7</b> (See fig. D6-3)	P	2,7	4,0	3,2	4,5	$\frac{1,33 \cdot b + 26}{e-2}$ max 3,5	$\frac{1,98 \cdot b + 30}{e-2}$ max 3,5	
		2,5	3,8					
	L	2,9	4,5	3,8	5,3	$\frac{1,45 \cdot b + 26}{e-2}$ max 3,8	$\frac{2,25 \cdot b + 32}{e-2}$ max 3,8	
		2,8	4,2					
	M	3,3	4,7	4,3	6,0	$\frac{1,66 \cdot b + 28}{e-2}$ max 4,0	$\frac{2,34 \cdot b + 33}{e-2}$ max 4,0	
		3,2	4,2					
	S	3,6	4,7	4,9	6,8	$\frac{1,82 \cdot b + 29}{e-2}$ max 4,3	$\frac{2,34 \cdot b + 33}{e-2}$ max 4,3	
		3,5	4,2					
	I	4,2	4,7	5,9	8,3	$\frac{2,07 \cdot b + 31}{e-2}$ max 4,7	$\frac{2,34 \cdot b + 33}{e-2}$ max 4,7	
		4,0	4,2					

b and e are in mm.

■ When the purlin has a wane on the side towards the Angle Bracket with an extent from the bottom up to the lower nail the formula in the gray square shall be checked additionally.

**Annex D7 – E20/3**

**Product Name:**

Product Name	Alternative name			
	UK	France	Denmark	Germany
E20/3	--	--	--	--

**Drawing:**

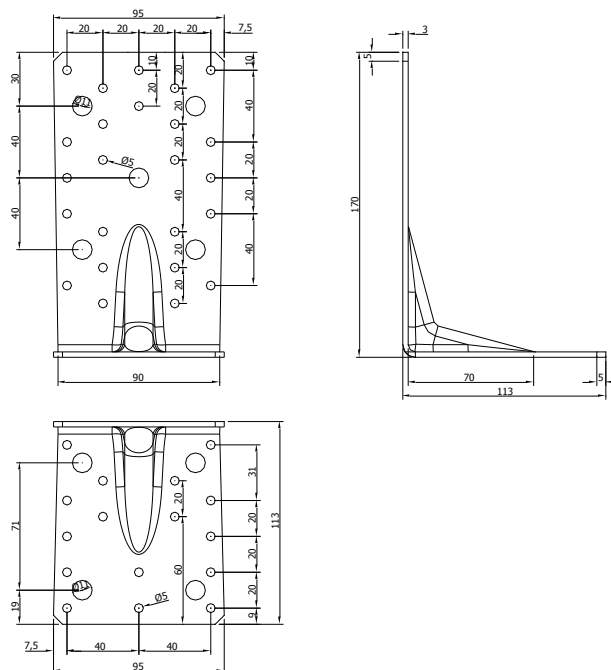

Figure D7-1 - E20/3

**Material:**

Standard material : S250GD + Z275 according to EN 10346

Or stainless steel according to clause II-1

**Nail pattern:**

Beam to beam connection

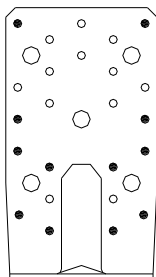

Figure D7-2  
Minimum nailing  
12 nails in vertical flap  
9 nails in the horizontal flap

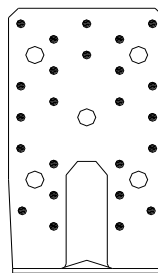
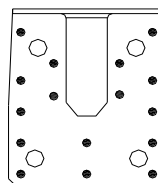
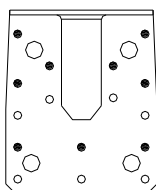

Figure D7-3  
Maximum nailing  
Nails in all holes  
24 nails in the vertical flap  
16 nails in the horizontal flap



Post to beam connection

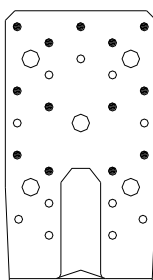
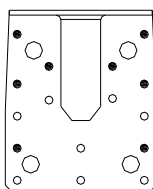

Figure D7-4  
13 nails in vertical flap  
8 nails in the horizontal flap



Beam to support with bolts

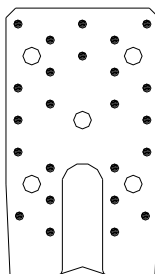
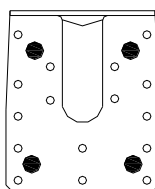

Figure D7-5  
24 nails in vertical flap  
4 bolts / anchors Ø10 in the horizontal flap



Post to support with bolts

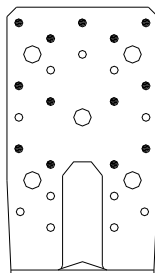
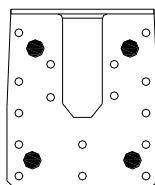

Figure D7-6  
13 nails in vertical flap  
4 bolts / anchors  $\varnothing 10$  in the horizontal flap



Trimmer connection

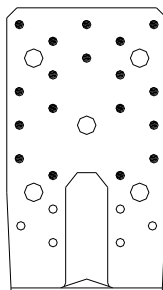
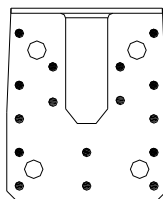

Figure D7-7  
18 nails in joist flap  
16 nails in the header flap



**Modified characteristic capacities:**

Table D7-1 E20/3, beam to beam connection

<b>2 Angle Brackets E20/3 per connection</b>					
<b>Modified characteristic capacity per connection (kN)</b>					
Nailing	Load duration	$R_{1,k}$		$R_{2,k} = R_{3,k}$	
		Connector nail according to ETA-04/0013			
		4,0x35	4,0x50	4,0x35	4,0x50
<b>Minimum nailing: 12+9</b>  (See fig. D7-2)	P	3,3	5,3	9,0	12,1
	L	3,9	6,2	10,5	14,2
	M	4,4	7,1	12,0	16,2
	S	5,0	7,9	13,5	18,2
	I	6,1	9,7	16,5	22,2
<b>Maximum nailing: 24+16</b>  (See fig. D7-3)	P	4,4	7,1	11,9	15,9
		3,2	5,2		
	L	5,1	8,2	13,9	18,6
		3,8	6,1		
	M	5,9	9,4	15,9	21,2
		4,3	7,0		
	S	6,6	10,6	17,9	23,9
		4,9	7,8		
	I	8,1	12,9	21,8	29,2
		6,0	9,6		

b and e are in mm.

■ When the purlin has a wane on the side towards the Angle Bracket with an extent from the bottom up to the lower nail the value in the gray square is valid.



Table D7-2 E20/3, beam to beam connection

<b>1 Angle Bracket E20 per connection</b>					
<b>Modified characteristic capacity per connection (kN)</b>					
Nailing	Load duration	$R_{1,k}$		$R_{2,k} = R_{3,k}$	
		Connector nail according to ETA-04/0013			
		4,0x35	4,0x50	4,0x35	4,0x50
<b>Minimum nailing: 12+9</b>  (See fig. D7-2)	P	$f \leq 58$ : $\frac{119}{f+73}$	$f \leq 80$ : $\frac{162}{f+73}$	4,5	6,1
		$f > 58$ : $\frac{53}{f}$	$f > 80$ : $\frac{85}{f}$		
	L	$f \leq 65$ : $\frac{131}{f+73}$	$f \leq 88$ : $\frac{181}{f+73}$	5,3	7,1
		$f > 65$ : $\frac{62}{f}$	$f > 88$ : $\frac{99}{f}$		
	M	$f \leq 71$ : $\frac{143}{f+73}$	$f \leq 94$ : $\frac{200}{f+73}$	6,0	8,1
$f > 71$ : $\frac{71}{f}$		$f > 94$ : $\frac{113}{f}$			
S	$f \leq 77$ : $\frac{155}{f+73}$	$f \leq 101$ : $\frac{219}{f+73}$	6,8	9,1	
	$f > 77$ : $\frac{79}{f}$	$f > 101$ : $\frac{127}{f}$			
I	$f \leq 87$ : $\frac{179}{f+73}$	$f \leq 112$ : $\frac{257}{f+73}$	8,3	11,1	
	$f > 87$ : $\frac{97}{f}$	$f > 112$ : $\frac{155}{f}$			

f are in mm.

Wane may not occur under the angle brackets.

Table D7-3 E20/3, beam to beam connection

<b>1 Angle Bracket E20 per connection</b>					
<b>Modified characteristic capacity per connection (kN)</b>					
Nailing	Load duration	$R_{1,k}$		$R_{2,k} = R_{3,k}$	
		Connector nail according to ETA-04/0013			
		4,0x35	4,0x50	4,0x35	4,0x50
<b>Maximum nailing: 24+16</b>  (See fig. D7-3)	P	$f \leq 58$ : $\frac{119}{f+73}$	$f \leq 80$ : $\frac{162}{f+73}$	6,0	8,0
		$f > 58$ : $\frac{53}{f}$	$f > 80$ : $\frac{85}{f}$		
	L	$f \leq 65$ : $\frac{131}{f+73}$	$f \leq 90$ : $\frac{181}{f+73}$	6,9	9,3
		$f > 65$ : $\frac{62}{f}$	$f > 90$ : $\frac{99}{f}$		
	M	$f \leq 71$ : $\frac{143}{f+73}$	$f \leq 95$ : $\frac{200}{f+73}$	7,9	10,6
$f > 71$ : $\frac{71}{f}$	$f > 95$ : $\frac{113}{f}$				
S	$f \leq 77$ : $\frac{155}{f+73}$	$f \leq 101$ : $\frac{219}{f+73}$	8,9	11,9	
$f > 77$ : $\frac{79}{f}$	$f > 101$ : $\frac{127}{f}$				
I	$f \leq 87$ : $\frac{179}{f+73}$	$f \leq 112$ : $\frac{257}{f+73}$	10,9	14,6	
$f > 87$ : $\frac{97}{f}$	$f > 112$ : $\frac{155}{f}$				

f are in mm.

Wane may not occur under the angle brackets.

Table D7-4 E20/3, post to beam connection

2 Angle Brackets E20 per connection					
Modified characteristic capacity per connection (kN)					
Nailing	Load duration	R <sub>1,k</sub>		R <sub>2,k</sub> = R <sub>3,k</sub>	
		Connector nail according to ETA-04/0013			
		4,0x35	4,0x50	4,0x35	4,0x50
Vertical flap: 13 Horizontal flap: 8  (See fig. D7-4)	P	3,3	5,3	7,1	9,5
	L	3,9	6,2	8,2	11,1
	M	4,4	7,1	9,4	12,7
	S	5,0	7,9	10,6	14,3
	I	6,1	9,7	12,9	17,5

Table D7-5 E20/3, beam to support with bolts

2 Angle Brackets E20 per connection					
Modified characteristic capacity per connection (kN)					
Nailing	Load duration:	R <sub>1,k</sub>		R <sub>2,k</sub> = R <sub>3,k</sub>	
		Connector nail according to ETA-04/0013:			
		4,0x35	4,0x50	4,0x35	4,0x50
Vertical flap: 24 Horizontal flap: 4 bolts  (See fig. D7-5)	P	32,2	42,6	23,4	26,8
		22,0	33,6		
	L	37,5	49,7	27,3	31,3
		25,6	39,2		
	M	42,9	56,8	31,2	35,8
		29,3	44,8		
	S	48,3	63,9	35,1	40,2
		33,0	50,4		
	I	59,0	78,1	42,9	49,2
		40,3	61,6		

■ When the purlin has a wane on the side towards the Angle Bracket with an extent from the bottom up to the lower nail the formula in the gray square shall be checked

Requirement for the bolts – see declaration under table D7-6

Table D7-6 E20/3, beam to support with bolts.

1 Angle Bracket E20 per connection					
Modified characteristic capacity per connection (kN)					
Nailing	Load duration:	R <sub>1,k</sub>		R <sub>2,k</sub> = R <sub>3,k</sub>	
		Connector nail according to ETA-04/0013:			
		4,0x35	4,0x50	4,0x35	4,0x50
Vertical flap: 24 Horizontal flap: 4 bolts  (see fig. D7-5)	P	f ≤ 4: <u>336</u> f+19,1	f ≤ 6: <u>336</u> f+19,1	11,7	14,2
		f > 4: <u>53</u> f	f > 6: <u>85</u> f		
	L	f ≤ 4: <u>336</u> f+19,1	f ≤ 8: <u>336</u> f+19,1	13,7	16,5
		f > 4: <u>62</u> f	f > 8: <u>99</u> f		
	M	f ≤ 5: <u>336</u> f+19,1	f ≤ 10: <u>336</u> f+19,1	15,6	18,9
	f > 5: <u>71</u> f	f > 10: <u>113</u> f			
S	f ≤ 6: <u>336</u> f+19,1	f ≤ 12: <u>336</u> f+19,1	17,6	21,3	
	f > 6: <u>79</u> f	f > 12: <u>127</u> f			
I	f ≤ 8: <u>336</u> f+19,1	f ≤ 16: <u>336</u> f+19,1	21,5	26,0	
	f > 8: <u>97</u> f	f > 16: <u>155</u> f			

f are in mm.

Force direction F<sub>1</sub>: the two bolts in the first row, next to the bending line, shall have a capacity to sustain an axial force of  $1,1 \times F_{1,d}$ .

Force direction F<sub>2</sub>: the bolt group shall have a capacity to sustain the followings:

F<sub>2,d</sub>; M<sub>X,F2</sub>=F<sub>2,d</sub> × 59mm; M<sub>Y,F2</sub>=F<sub>2,d</sub> × 89mm see picture

The force F<sub>2</sub> must be applied to each E20/3. So for a connection with two E20/3, the bolt group for one angle bracket has to be calculated for F<sub>2</sub>/2, same for force direction F<sub>1</sub>.

Wane may not occur under the angle brackets.

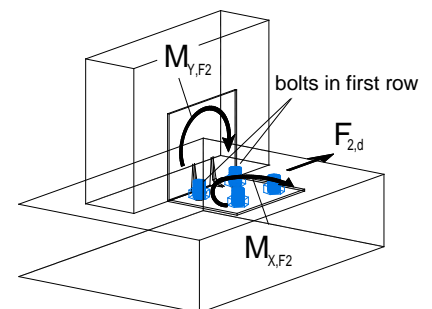

Table D7-7 E20/3, post to support with bolts

<b>2 Angle Brackets E20 per connection</b>				
<b>Modified characteristic capacity per connection (kN)</b>				
<b>Load duration:</b>	<b>R<sub>1,k</sub></b>		<b>R<sub>2,k</sub> = R<sub>3,k</sub></b>	
	Connector nail according to ETA-04/0013:			
	4,0x35	4,0x50	4,0x35	4,0x50
Nailing: Vertical flap: 13 / Horizontal flap: 4 bolts (see fig. D7-6)				
P	18,1	24,0	15,3	17,5
L	21,1	28,0	17,8	20,4
M	24,1	32,0	20,4	23,3
S	27,2	36,0	22,9	26,2
I	33,2	44,0	28,0	32,0

Requirement for the bolts – see declaration under table D7-6

Table D7-8 E20/3, trimmer connection

<b>Modified characteristic capacity per connection (kN) <sup>1)</sup></b>					
<b>Nailing</b>	<b>Load duration</b>	<b>2 Angle Brackets E20 per connection</b>		<b>1 Angle Bracket E20 per connection</b>	
		<b>R<sub>2,k</sub> = R<sub>3,k</sub></b>		<b>R<sub>2,k</sub> = R<sub>3,k</sub></b>	
		Connector nail according to ETA-04/0013			
		4,0x35	4,0x50	4,0x35	4,0x50
Joist flap: 18	P	7,6	11,6	3,8	5,8
	L	8,9	13,5	4,4	6,7
Header flap: 16	M	10,1	15,4	5,1	7,7
	S	11,4	17,4	5,7	8,7
See fig. D7-7	I	13,9	21,2	7,0	10,6

Wane may not occur under the angle brackets.



**Nail pattern:**

Beam to beam connection

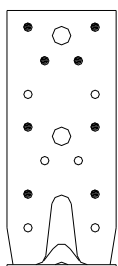

Figure D8-2  
Minimum nailing  
8 nails in vertical flap  
8 nails in the horizontal flap

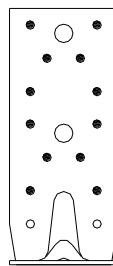

Figure D8-3  
Maximum nailing  
12 nails in the vertical flap  
14 nails in the horizontal flap

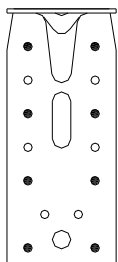

Figure D8-4  
10 nails in vertical flap  
14 nails in the horizontal flap

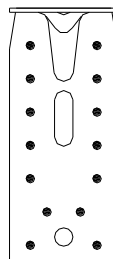

Figure D8-5  
12 nails in vertical flap  
14 nails in the horizontal flap

Post to beam connection

Trimmer connection

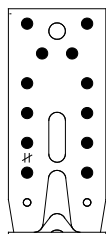
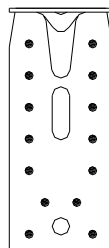
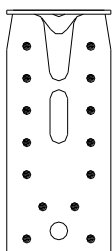
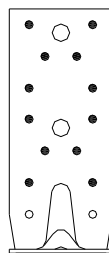
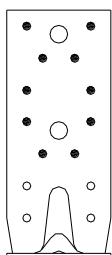
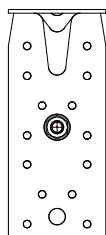

Figure D8-5  
12 nails in vertical flap  
1 bolt in the horizontal flap



**Modified characteristic capacities:**

Table D8-1 E9/2.5, beam to beam connection

<b>2 Angle Brackets E9 per connection</b>						
<b>Modified characteristic capacity per connection (kN)</b>						
Nailing	Load duration	$R_{1,k}$		$R_{2,k} = R_{3,k}$		
		Connector nail according to ETA-04/0013				
		4,0x35	4,0x50	4,0x35	4,0x50	
<b>Minimum nailing: 8+8</b>  See fig. D8-2	P	1,1	1,9	4,0	5,3	
		1,0	1,6			
	L	1,3	2,3	4,6	6,2	
		1,1	1,8			
	M	1,5	2,6	5,3	7,1	
		1,3	2,1			
	S	1,7	3,0	5,9	8,0	
		1,5	2,3			
	I	2,2	3,9	7,2	9,7	
		1,8	2,9			
	<b>Maximum nailing: 12+14</b>  See fig. D8-3	P	2,9	4,8	5,7	7,8
			2,2	3,6		
L		3,4	5,7	6,6	9,1	
		2,6	4,2			
M		3,9	6,7	7,6	10,4	
		3,0	4,8			
S		4,5	7,6	8,5	11,7	
		3,4	5,4			
I		5,6	9,5	10,4	14,3	
		4,1	6,6			

When the purlin has a wane on the side towards the Angle Bracket with an extent from the bottom up to the lower nail the value in the gray square is valid.



Table D8-2 E9/2.5, beam to beam connection

<b>1 Angle Bracket E9 per connection</b>					
<b>Modified characteristic capacity per connection (kN)</b>					
Nailing	Load duration	$R_{1,k}$		$R_{2,k} = R_{3,k}$	
		Connector nail according to ETA-04/0013			
		4,0x35	4,0x50	4,0x35	4,0x50
<b>Minimum nailing: 8+8</b> See fig. D8-2	P	$f \leq 24$ : $\frac{45}{f+62,5}$	$f \leq 31$ : $\frac{60}{f+62,5}$	2,0	2,7
		$f > 24$ : $\frac{12}{f}$	$f > 31$ : $\frac{20}{f}$		
	L	$f \leq 26$ : $\frac{49}{f+62,5}$	$f \leq 27$ : $\frac{67}{f+62,5}$	2,3	3,1
		$f > 26$ : $\frac{15}{f}$	$f > 27$ : $\frac{20}{f}$		
	M	$f \leq 28$ : $\frac{53}{f+62,5}$	$f \leq 24$ : $\frac{74}{f+62,5}$	2,6	3,5
	$f > 28$ : $\frac{17}{f}$	$f > 24$ : $\frac{20}{f}$			
S	$f \leq 30$ : $\frac{58}{f+62,5}$	$f \leq 21$ : $\frac{80}{f+62,5}$	3,0	4,0	
	$f > 30$ : $\frac{19}{f}$	$f > 21$ : $\frac{20}{f}$			
I	$f \leq 28$ : $\frac{66}{f+62,5}$	$f \leq 17$ : $\frac{94}{f+62,5}$	3,6	4,9	
	$f > 28$ : $\frac{20}{f}$	$f > 17$ : $\frac{20}{f}$			

f are in mm.

Wane may not occur under the angle brackets.

Table D8-3 E9/2.5, beam to beam connection

1 Angle Brackets per connection					
Modified characteristic capacity per connection (kN)					
Nailing	Load duration	$R_{1,k}$		$R_{2,k} = R_{3,k}$	
		Connector nail according to ETA-04/0013			
		4,0x35	4,0x50	4,0x35	4,0x50
<b>Maximum nailing: 12+14</b>  See fig. D8-3	P	$f \leq 25:$ $\frac{35}{f+44}$	$f \leq 38:$ $\frac{43}{f+44}$	2,8	3,9
		$f > 25:$ $\frac{12}{f}$	$f > 38:$ $\frac{20}{f}$		
	L	$f \leq 29:$ $\frac{37}{f+44}$	$f \leq 33:$ $\frac{47}{f+44}$	3,3	4,5
		$f > 29:$ $\frac{15}{f}$	$f > 33:$ $\frac{20}{f}$		
	M	$f \leq 32:$ $\frac{39}{f+44}$	$f \leq 29:$ $\frac{51}{f+44}$	3,8	5,2
	$f > 32:$ $\frac{17}{f}$	$f > 29:$ $\frac{20}{f}$			
S	$f \leq 35:$ $\frac{42}{f+44}$	$f \leq 26:$ $\frac{55}{f+44}$	4,3	5,8	
	$f > 35:$ $\frac{19}{f}$	$f > 26:$ $\frac{20}{f}$			
I	$f \leq 34:$ $\frac{47}{f+44}$	$f \leq 21:$ $\frac{62}{f+44}$	5,2	7,1	
	$f > 34:$ $\frac{20}{f}$	$f > 21:$ $\frac{20}{f}$			

f are in mm.

Wane may not occur under the angle brackets.

Table D8-4 E9/2.5, post to beam connection

<b>2 Angle Bracket per connection</b>					
Nailing	Load duration	<b>Modified characteristic capacity per connection (kN)</b>			
		$R_{1,k}$		$R_{2,k} = R_{3,k}$	
		Connector nail according to ETA-04/0013:			
		4,0x35	4,0x50	4,0x35	4,0x50
Vertical flap: 10 Horizontal flap: 14 See fig. D8-4	P	1,8	3,0	3,3	5,1
	L	2,1	3,5	3,9	6,0
	M	2,4	4,1	4,4	6,8
	S	2,8	4,7	5,0	7,7
	I	3,5	5,9	6,1	9,4

Table D8-5 E9/2.5, trimmer connection

<b>Modified characteristic capacity per connection (kN)</b>					
Nailing	Load duration	<b>2 Angle Brackets</b>		<b>1 Angle Bracket</b>	
		$R_{2,k} = R_{3,k}$		$R_{2,k} = R_{3,k}$	
		Connector nail according to ETA-04/0013:			
		4,0x35	4,0x50	4,0x35	4,0x50
Vertical flap: 12 Horizontal flap: 14 See fig. D8-5	P	5,7	7,8	2,8	3,9
	L	6,6	9,1	3,3	4,5
	M	7,6	10,4	3,8	5,2
	S	8,5	11,7	4,3	5,8
	I	10,4	14,3	5,2	7,1

Table D8-6 E9/2.5 – Beam to rigid support connection

<b>2 Angle Brackets E9/2.5</b>		
Beam to rigid support connection		
Characteristic capacity for two E9/2.5		
12 Ø4,0x35 nails in the vertical flange / 1 anchor bolts Ø10 in the horizontal flange		
	$R_{1,k}$	$R_{2,k}/R_{3,k}$
Characteristic value $R_k$ [kN]	6,0	-

The bolt group must be able to resist to  $R_{1,tension\ of\ bolt,d} = F_{1,d} \times 2,7$

**Annex D9 – E9S/2.5**

**Product Name:**

Product Name	Alternative name			
	UK	France	Denmark	Germany
E9S/2.5	--	--	--	--

**Drawing:**

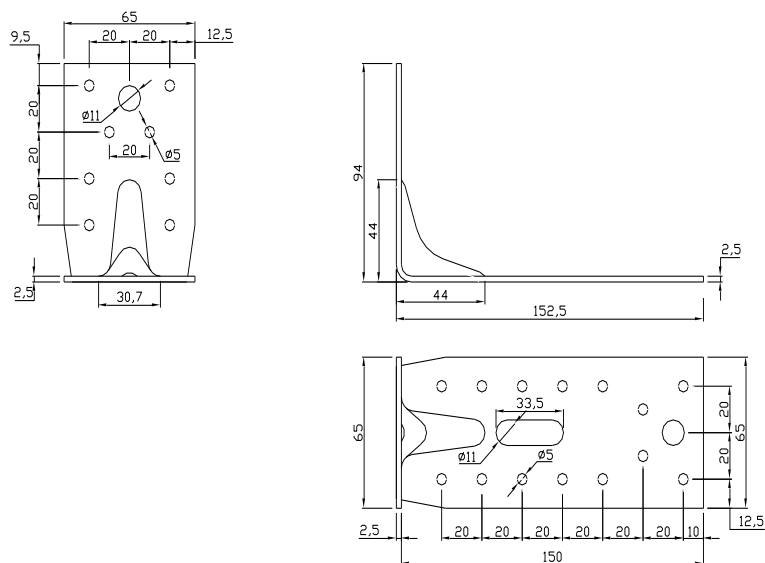

Figure D9-1 - E9S/2.5

**Material:**

Standard material : S250GD + Z275 according to EN 10346

Or stainless steel according to clause II-1

**Nail pattern:**

Beam to beam connection

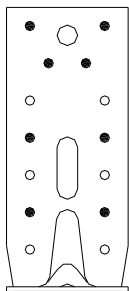

Figure D9-2  
Minimum nailing  
8 nails in vertical flap  
6 nails in the horizontal flap

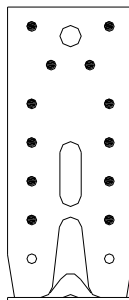

Figure D9-3  
Maximum nailing  
12 nails in the vertical flap  
8 nails in the horizontal flap

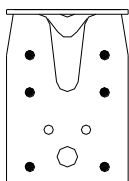

Figure D9-4  
10 nails in vertical flap  
8 nails in the horizontal flap

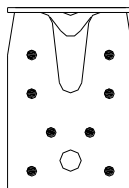
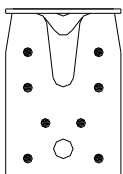
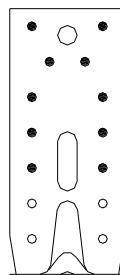
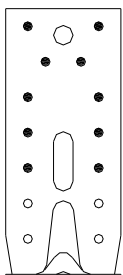

Figure D9-5  
10 nails in vertical flap  
8 nails in the horizontal flap

Post to beam connection

Trimmer connection



**Modified characteristic capacities:**

Table D9-1 E9S/2.5, beam to beam connection

<b>2 Angle Brackets E9S per connection</b>						
<b>Modified characteristic capacity per connection (kN)</b>						
Nailing	Load duration	$R_{1,k}$		$R_{2,k} = R_{3,k}$		
		Connector nail according to ETA-04/0013				
		4,0x35	4,0x50	4,0x35	4,0x50	
<b>Minimum nailing: 8+6</b>  See fig. D9-2	P	1,0	1,7	4,1	5,2	
		0,6	1,0			
	L	1,2	2,1	4,8	6,1	
		0,8	1,2			
	M	1,4	2,4	5,4	7,0	
		0,9	1,4			
	S	1,6	2,8	6,1	7,9	
		1,0	1,6			
	I	2,0	3,5	7,5	9,6	
		1,2	1,9			
	<b>Maximum nailing: 12+8</b>  See fig. D9-3	P	2,7	4,5	5,3	7,1
			2,1	3,4		
L		3,2	5,4	6,2	8,3	
		2,5	4,0			
M		3,7	6,2	7,0	9,5	
		2,9	4,6			
S		4,2	7,1	7,9	10,7	
		3,2	5,2			
I		5,3	8,9	9,7	13,0	
		3,9	6,3			

□ When the purlin has a wane on the side towards the Angle Bracket with an extent from the bottom up to the lower nail the value in the gray square is valid.

Table D9-2 E9S/2.5, beam to beam connection

1 Angle Brackets per connection					
Modified characteristic capacity per connection (kN)					
Nailing	Load duration	$R_{1,k}$		$R_{2,k} = R_{3,k}$	
		Connector nail according to ETA-04/0013			
		4,0x35	4,0x50	4,0x35	4,0x50
<b>Minimum nailing: 8+6</b>  See fig. D9-2	P	$f \leq 28:$ $\frac{83}{f+84}$	$f \leq 17:$ $\frac{120}{f+84}$	2,0	2,6
		$f > 28:$ $\frac{20}{f}$	$f > 17:$ $\frac{20}{f}$		
	L	$f \leq 24:$ $\frac{93}{f+84}$	$f \leq 15:$ $\frac{137}{f+84}$	2,4	3,1
		$f > 24:$ $\frac{20}{f}$	$f > 15:$ $\frac{20}{f}$		
	M	$f \leq 21:$ $\frac{103}{f+84}$	$f \leq 13:$ $\frac{154}{f+84}$	2,7	3,5
	$f > 21:$ $\frac{20}{f}$	$f > 13:$ $\frac{20}{f}$			
S	$f \leq 18:$ $\frac{114}{f+84}$	$f \leq 11:$ $\frac{170}{f+84}$	3,1	3,9	
	$f > 18:$ $\frac{20}{f}$	$f > 11:$ $\frac{20}{f}$			
I	$f \leq 15:$ $\frac{134}{f+84}$	$f \leq 9:$ $\frac{204}{f+84}$	3,7	4,8	
	$f > 15:$ $\frac{20}{f}$	$f > 9:$ $\frac{20}{f}$			

f are in mm.

Wane may not occur under the angle brackets.

Table D9-3 E9S/2.5, beam to beam connection

1 Angle Brackets per connection					
Modified characteristic capacity per connection (kN)					
Nailing	Load duration	$R_{1,k}$		$R_{2,k} = R_{3,k}$	
		Connector nail according to ETA-04/0013			
		4,0x35	4,0x50	4,0x35	4,0x50
<b>Maximum nailing: 12+8</b>  See fig. D9-3	P	$f \leq 27$ : $\frac{33}{f+44}$	$f \leq 43$ : $\frac{40}{f+44}$	2,6	3,6
		$f > 27$ : $\frac{12}{f}$	$f > 43$ : $\frac{20}{f}$		
	L	$f \leq 32$ : $\frac{35}{f+44}$	$f \leq 38$ : $\frac{44}{f+44}$	3,1	4,2
		$f > 32$ : $\frac{15}{f}$	$f > 38$ : $\frac{20}{f}$		
	M	$f \leq 36$ : $\frac{37}{f+44}$	$f \leq 34$ : $\frac{47}{f+44}$	3,5	4,7
	$f > 36$ : $\frac{17}{f}$	$f > 34$ : $\frac{20}{f}$			
S	$f \leq 41$ : $\frac{39}{f+44}$	$f \leq 30$ : $\frac{50}{f+44}$	4,0	5,3	
	$f > 41$ : $\frac{19}{f}$	$f > 30$ : $\frac{20}{f}$			
I	$f \leq 39$ : $\frac{43}{f+44}$	$f \leq 25$ : $\frac{57}{f+44}$	4,8	6,5	
	$f > 39$ : $\frac{20}{f}$	$f > 25$ : $\frac{20}{f}$			

f are in mm.

Wane may not occur under the angle brackets.



Table D9-4 E9S/2.5, post to beam connection

<b>2 Angle Brackets E9S per connection</b>					
<b>Modified characteristic capacity per connection (kN)</b>					
Nailing	Load duration	$R_{1,k}$		$R_{2,k} = R_{3,k}$	
		Connector nail according to ETA-04/0013:			
		4,0x35	4,0x50	4,0x35	4,0x50
Vertical flap: 10 Horizontal flap: 8  See fig. D9-4	P	1,7	2,8	4,2	5,8
	L	2,0	3,3	4,9	6,8
	M	2,3	3,9	5,6	7,7
	S	2,6	4,4	6,3	8,7
	I	3,3	5,5	7,7	10,6

Table D9-5 E9S/2.5, trimmer connection

<b>Modified characteristic capacity per connection (kN)</b>					
Nailing	Load duration	<b>2 Angle Brackets</b>		<b>1 Angle Bracket</b>	
		$R_{2,k} = R_{3,k}$		$R_{2,k} = R_{3,k}$	
		Connector nail according to ETA-04/0013			
		4,0x35	4,0x50	4,0x35	4,0x50
Vertical flap: 10 Horizontal flap: 8  See fig. D9-5	P	4,1	5,2	2,0	2,6
	L	4,8	6,1	2,4	3,1
	M	5,4	7,0	2,7	3,5
	S	6,1	7,9	3,1	3,9
	I	7,5	9,6	3,7	4,8

**Annex D10 – ABR9015**

**Product Name:**

Product Name	Alternative name			
	UK	France	Denmark	Germany
ABR9015	--	--	--	--

**Drawing:**

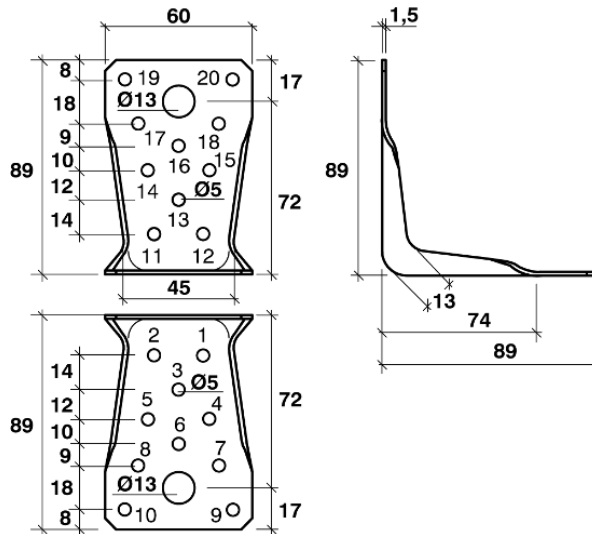

Figure D10-1 - ABR9015

**Material:**

Standard material : S250GD + Z275 according to EN 10346  
 Or stainless steel according to clause II-1

**Nail pattern:**

Beam

to beam connection

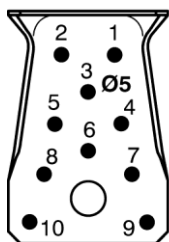
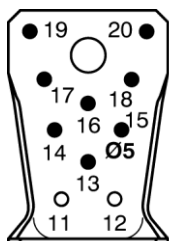

Figure D10-2  
 8 nails in vertical flap  
 10 nails in the horizontal flap

**Modified characteristic capacities:**

Table D10-1 ABR9015, beam to beam connection – connector screws

2 Angle Bracket ABR9015 per connection		Modified characteristic capacity per connection (kN)		
Connector screw CSA5,0x40 according to	Load duration	$R_{1,k}$	$R_{2,k} = R_{3,k}$	$R_{4,k} = R_{5,k}$
<b>Maximum nailing: 8+10</b>  See fig. D10-2	P	7,1	6,3	$\frac{3,8 \cdot b + 207}{e}$ max 17,2
	L	8,2	7,4	$\frac{4,2 \cdot b + 211}{e}$ max 20,0
	M	9,3	8,4	$\frac{4,5 \cdot b + 215}{e}$ max 22,7
	S	10,5	9,5	$\frac{4,9 \cdot b + 219}{e}$ max 25,5
	I	12,8	11,6	$\frac{5,6 \cdot b + 227}{e}$ max 31,0

Wane may occur under the angle brackets.

Table D10-2 ABR9015, beam to beam connection – connector screws

1 Angle Bracket ABR9015 per connection		Modified characteristic capacity per connection (kN)			
Connector screw CSA5,0x40 according to ETA-04/0013:	Load duration	$R_{1,k}$	$R_{2,k} = R_{3,k}$	$R_{4,k}$	$R_{5,k}$
Maximum nailing: 8+10  See fig. D10-2	P	$f \leq 28$ : <u>87,0</u> $f+32$	3,2	$e \leq 6$ : 11,1	$e \leq 48$ : <u>104</u> 63-e
		$f > 28$ : <u>40,5</u> f		$6 < e \leq 85$ : <u>71</u> e	$48 < e \leq 0,56 \cdot b + 31$ : 6,7
				$e > 85$ : <u>45</u> $e-32$	$e > 0,56 \cdot b + 31$ : <u>3,8 \cdot b - 218</u> $e-63$
	L	$f \leq 29$ : <u>95,0</u> $f+32$	3,7	$e \leq 6$ : 12,9	$e \leq 47$ : <u>121</u> 63-e
		$f > 29$ : <u>44,6</u> f		$6 < e \leq 85$ : <u>71</u> e	$47 < e \leq 0,54 \cdot b + 31$ : 7,8
				$e > 85$ : <u>45</u> $e-32$	$e > 0,54 \cdot b + 31$ : <u>4,2 \cdot b - 247</u> $e-63$
	M	$f \leq 25$ : <u>102,0</u> $f+32$	4,2	$e \leq 5$ : 14,8	$e \leq 47$ : <u>138</u> 63-e
		$f > 25$ : <u>44,6</u> f		$5 < e \leq 85$ : <u>71</u> e	$47 < e \leq 0,52 \cdot b + 32$ : 8,8
				$e > 85$ : <u>45</u> $e-32$	$e > 0,52 \cdot b + 32$ : <u>4,5 \cdot b - 275</u> $e-63$
	S	$f \leq 22$ : <u>108,9</u> $f+32$	4,7	$e \leq 4$ : 16,6	$e \leq 47$ : <u>171</u> 63-e
		$f > 22$ : <u>44,6</u> f		$4 < e \leq 85$ : <u>71</u> e	$46 < e \leq 0,50 \cdot b + 31$ : 9,8
				$e > 85$ : <u>45</u> $e-32$	$e > 0,50 \cdot b + 31$ : <u>4,9 \cdot b - 319</u> $e-63$
I	$f \leq 18$ : <u>123,1</u> $f+32$	5,8	$e \leq 4$ : 20,3	$e \leq 47$ : <u>190</u> 63-e	
	$f > 18$ : <u>44,6</u> f		$4 < e \leq 85$ : <u>71</u> e	$47 < e \leq 0,48 \cdot b + 33$ : 11,8	
			$e > 85$ : <u>45</u> $e-32$	$e > 0,48 \cdot b + 33$ : <u>5,6 \cdot b - 360</u> $e-63$	

f is in mm.

Wane may occur under the angle brackets

Table D10-3 ABR9015, beam to beam connection – connector nails

k<sub>modi</sub> = 1.18

ABR9015		2 Angle Brackets per connection Timber to timber connection with nails							
		Modified characteristic capacity per connection (kN)							
Nailing	Load duration	R <sub>1,k</sub>				R <sub>2,k</sub> = R <sub>3,k</sub>			
		Connector nail according to ETA-04/0013							
		4,0x35	4,0x40	4,0x50	4,0x60	4,0x35	4,0x40	4,0x50	4,0x60
Maximum nailing: 8+10  See fig. D10-2	P	2,2	2,6	3,3	4,1	3,8	4,3	4,8	5,8
	L	2,5	2,9	3,8	4,7	4,4	5,0	5,6	6,8
	M	2,8	3,3	4,3	5,4	5,0	5,7	6,5	7,8
	S	3,1	3,7	4,8	6,0	5,7	6,4	7,3	8,7
	I	3,7	4,5	5,9	7,3	6,9	7,8	8,9	10,7

Wane may occur under the angle brackets.

Table D10-4 ABR9015, beam to beam connection – connector nails

K<sub>modi</sub> = 1.18

ABR9015		1 Angle Brackets per connection - Timber to timber connection with nails							
		Modified characteristic capacity per connection (kN)							
Nailing	Load duration	R <sub>1,k</sub>				R <sub>2,k</sub> = R <sub>3,k</sub>			
		Connector nail according to ETA-04/0013							
		4,0x35	4,0x40	4,0x50	4,0x60	4,0x35	4,0x40	4,0x50	4,0x60
Maximum nailing: 8+10 See fig. D10-2	P	f ≤ 8 : $\frac{57}{f+32}$ f > 8 : $\frac{11,3}{f}$	f ≤ 10 : $\frac{59}{f+32}$ f > 10 : $\frac{13,8}{f}$	f ≤ 13 : $\frac{64}{f+32}$ f > 13 : $\frac{18,2}{f}$	f ≤ 16 : $\frac{69}{f+32}$ f > 16 : $\frac{22,9}{f}$	1,9	2,1	2,4	2,9
	L	f ≤ 9 : $\frac{59}{f+32}$ f > 9 : $\frac{13,2}{f}$	f ≤ 12 : $\frac{62}{f+32}$ f > 12 : $\frac{16,1}{f}$	f ≤ 15 : $\frac{67}{f+32}$ f > 15 : $\frac{21,3}{f}$	f ≤ 19 : $\frac{73}{f+32}$ f > 19 : $\frac{26,7}{f}$	2,2	2,5	2,8	3,4
	M	f ≤ 10 : $\frac{61}{f+32}$ f > 10 : $\frac{15,1}{f}$	f ≤ 13 : $\frac{64}{f+32}$ f > 13 : $\frac{18,4}{f}$	f ≤ 17 : $\frac{70}{f+32}$ f > 17 : $\frac{24,3}{f}$	f ≤ 21 : $\frac{77}{f+32}$ f > 21 : $\frac{30,5}{f}$	2,5	2,8	3,2	3,9
	S	f ≤ 12 : $\frac{62,6}{f+32}$ f > 12 : $\frac{17}{f}$	f ≤ 15 : $\frac{66,4}{f+32}$ f > 15 : $\frac{20,6}{f}$	f ≤ 19 : $\frac{73}{f+32}$ f > 19 : $\frac{27,3}{f}$	f ≤ 24 : $\frac{81}{f+32}$ f > 24 : $\frac{34,3}{f}$	2,8	3,2	3,6	4,4
	I	f ≤ 15 : $\frac{66,6}{f+32}$ f > 15 : $\frac{20,8}{f}$	f ≤ 17 : $\frac{71,2}{f+32}$ f > 17 : $\frac{25,2}{f}$	f ≤ 23 : $\frac{80}{f+32}$ f > 23 : $\frac{33,4}{f}$	f ≤ 29 : $\frac{89}{f+32}$ f > 29 : $\frac{41,9}{f}$	3,5	3,9	4,4	5,3

Wane may occur under the angle brackets.

## Annex D11 – ABR9020

### Product Name:

Product Name	Alternative name			
	UK	France	Denmark	Germany
ABR9020	--	--	--	--
ABR9020S	--	--	--	--
ABR9020S2	--	--	--	--

### Drawing:

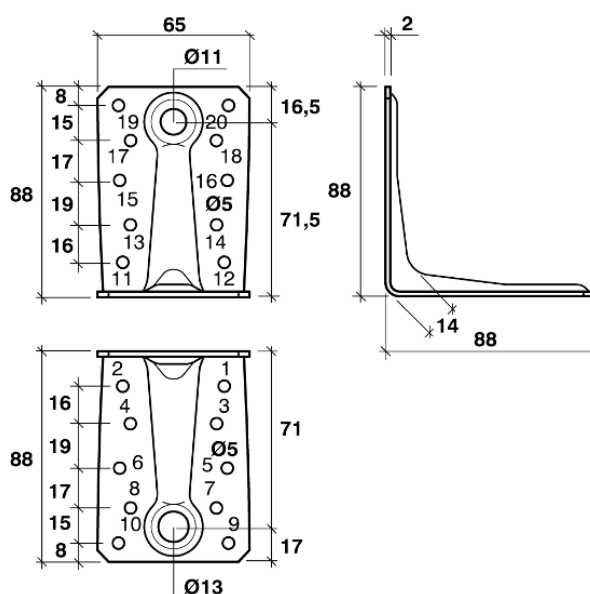

Figure D11-1 - ABR9020

### Material:

Standard material : S250GD + Z275 according to EN 10346

Or stainless steel according to clause II-1

### Nail pattern:

Beam to beam connection

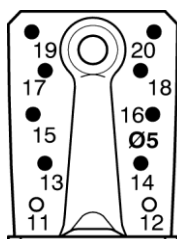

Figure D11-2  
Maximum nailing  
8 nails in vertical flap  
10 nails in the horizontal flap

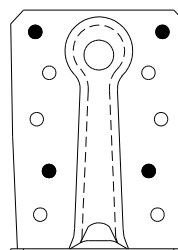
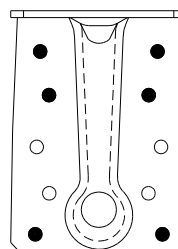
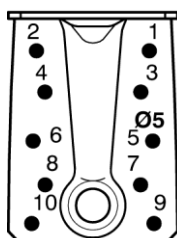

Figure D11-3  
Minimum nailing  
4 nails in vertical flap  
6 nails in the horizontal flap



Beam to steel (6 mm S355) connection

Figure D11-4  
8 CNA4,0x60 nails in vertical flap  
4 PDPA-75 nails in the horizontal flap

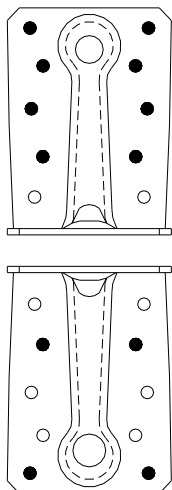
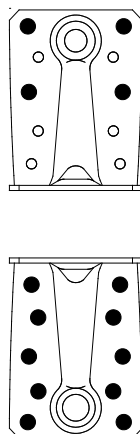

Figure D11-5  
Beam to column  
10 nails in vertical flap  
4 nails in the horizontal flap



**Modified characteristic capacities:**

Table D11-1 ABR9020, beam to beam connection - connector screws

2 Angle Bracket ABR9020 per connection		Modified characteristic capacity per connection (kN)		
Connector screw CSA5,0x40 according to	Load duration	$R_{1,k}$	$R_{2,k} = R_{3,k}$	$R_{4,k} = R_{5,k}$
Maximum nailing: 8+10 See fig. D11-2	P	8,5	7,6	$\frac{4,9 \cdot b + 260}{e}$ max 17,7
	L	9,9	8,9	$\frac{5,4 \cdot b + 264}{e}$ max 20,5
	M	11,3	10,1	$\frac{5,9 \cdot b + 267}{e}$ max 23,3
	S	12,7	11,4	$\frac{6,3 \cdot b + 270}{e}$ max 26,1
	I	14,7	13,9	$\frac{7,3 \cdot b + 277}{e}$ max 31,7

Wane may not occur under the angle brackets



Table D11-2 ABR9020, beam to beam connection - connector screws

1 Angle Bracket ABR9020 per connection		Modified characteristic capacity per connection (kN)			
Connector screw CSA5,0x40 according to ETA-04/0013:	Load duration	$R_{1,k}$	$R_{2,k} = R_{3,k}$	$R_{4,k}$	$R_{5,k}$
Maximum nailing: <b>8+10</b>  See fig. D11-2	P	$f \leq 175$ : $\frac{57}{f+29}$	3,8	$e \leq 8$ : 11,1	$e \leq 49$ : 118
		$f > 175$ : $\frac{49,1}{f+1}$		$8 < e \leq 63$ : $\frac{91}{e}$	$49 < e \leq 0,68 \cdot b + 27$ : 7,2
				$e > 63$ : $\frac{49}{e-29}$	$e > 0,68 \cdot b + 27$ : $\frac{4,9 \cdot b - 270}{e-65}$
	L	$f \leq 90$ : $\frac{64}{f+29}$	4,4	$e \leq 7$ : 12,9	$e \leq 48$ : 138
		$f > 90$ : $\frac{49,1}{f+1}$		$7 < e \leq 63$ : $\frac{91}{e}$	$48 < e \leq 0,65 \cdot b + 28$ : 8,3
				$e > 63$ : $\frac{49}{e-29}$	$e > 0,65 \cdot b + 28$ : $\frac{5,4 \cdot b - 305}{e-65}$
	M	$f \leq 60$ : $\frac{71,7}{f+29}$	5,1	$e \leq 6$ : 14,8	$e \leq 48$ : 157
		$f > 60$ : $\frac{49,1}{f+1}$		$6 < e \leq 63$ : $\frac{91}{e}$	$45 < e \leq 0,63 \cdot b + 29$ : 9,3
				$e > 63$ : $\frac{49}{e-29}$	$e > 0,63 \cdot b + 29$ : $\frac{5,9 \cdot b - 339}{e-65}$
	S	$f \leq 45$ : $\frac{79,1}{f+29}$	5,7	$e \leq 5$ : 16,6	$e \leq 48$ : 177
		$f > 45$ : $\frac{49,1}{f+1}$		$5 < e \leq 63$ : $\frac{91}{e}$	$48 < e \leq 0,61 \cdot b + 29$ : 10,4
				$e > 63$ : $\frac{49}{e-29}$	$e > 0,61 \cdot b + 29$ : $\frac{6,3 \cdot b - 374}{e-65}$
I	$f \leq 30$ : $\frac{93,9}{f+29}$	7,0	$e \leq 4$ : 20,3	$e \leq 48$ : 216	
	$f > 30$ : $\frac{49,1}{f+1}$		$4 < e \leq 63$ : $\frac{91}{e}$	$48 < e \leq 0,58 \cdot b + 30$ : 12,5	
			$e > 63$ : $\frac{49}{e-29}$	$e > 0,58 \cdot b + 30$ : $\frac{7,3 \cdot b - 443}{e-65}$	

f is in mm.

Wane may not occur under the angle bracket

Table D11-3 2 angle brackets ABR9020, beam to beam connection - connector nails

2 ABR9020 per connection					Modified characteristic capacity per connection (kN)					
Nailing	Load duration	R <sub>1,k</sub>			R <sub>2,k</sub> = R <sub>3,k</sub>			R <sub>4,k</sub> = R <sub>5,k</sub>		
		Connector nail according to ETA-04/0013								
		4,0x35	4,0x40	4,0x60	4,0x35	4,0x40	4,0x60	4,0x35	4,0x40	4,0x60
<b>Maximum</b> Nailing 8+10  See fig. D11-2	P	5,8	6,5	8,9	5,7	6,2	7,8	$\frac{3,6 \cdot b + 259}{e}$ max 5,9	$\frac{3,9 \cdot b + 261}{e}$ max 6,8	$\frac{4,8 \cdot b + 269}{e}$ max 10,7
	L	6,8	7,6	10,4	6,6	7,2	9,1	$\frac{3,8 \cdot b + 260}{e}$ max 6,7	$\frac{4,1 \cdot b + 263}{e}$ max 7,8	$\frac{5,2 \cdot b + 273}{e}$ max 12,4
	M	7,8	8,6	11,9	7,5	8,3	10,4	$\frac{4,0 \cdot b + 262}{e}$ max 7,5	$\frac{4,3 \cdot b + 265}{e}$ max 8,8	$\frac{5,5 \cdot b + 276}{e}$ max 14,0
	S	8,7	9,7	13,4	8,5	9,3	11,7	$\frac{4,2 \cdot b + 264}{e}$ max 8,3	$\frac{4,5 \cdot b + 267}{e}$ max 9,8	$\frac{5,9 \cdot b + 279}{e}$ max 15,6
	I	10,7	11,9	16,4	10,4	11,4	14,4	$\frac{4,6 \cdot b + 267}{e}$ max 9,9	$\frac{5,0 \cdot b + 271}{e}$ max 11,7	$\frac{6,7 \cdot b + 286}{e}$ max 18,9
<b>Minimum</b> Nailing 4+6  See fig. D11-3	P	2,9	3,5	5,9	3,5	3,8	4,9	$\frac{3,6 \cdot b + 259}{e}$ max 3,7	$\frac{3,9 \cdot b + 261}{e}$ max 4,2	$\frac{4,8 \cdot b + 269}{e}$ max 6,3
	L	3,4	4,1	6,9	4,1	4,5	5,7	$\frac{3,8 \cdot b + 260}{e}$ max 4,1	$\frac{4,1 \cdot b + 263}{e}$ max 4,7	$\frac{5,2 \cdot b + 273}{e}$ max 7,2
	M	3,9	4,7	7,8	4,7	5,1	6,5	$\frac{4,0 \cdot b + 262}{e}$ max 4,5	$\frac{4,3 \cdot b + 265}{e}$ max 5,3	$\frac{5,5 \cdot b + 276}{e}$ max 8,1
	S	4,4	5,3	8,8	5,3	5,8	7,3	$\frac{4,2 \cdot b + 264}{e}$ max 5,0	$\frac{4,5 \cdot b + 267}{e}$ max 5,8	$\frac{5,9 \cdot b + 279}{e}$ max 9,0
	I	5,4	6,5	10,8	6,5	7,1	9,0	$\frac{4,6 \cdot b + 267}{e}$ max 5,9	$\frac{5,0 \cdot b + 271}{e}$ max 6,9	$\frac{6,7 \cdot b + 286}{e}$ max 10,8

b and e are in mm.

Wane may not occur under the angle brackets

Table D11-4 1 angle bracket ABR9020, beam to beam connection – maximum nailing - connector nails

1 Angle Bracket ABR9020 per connection		Modified characteristic capacity per connection (kN)													
Nailing	Load duration	R <sub>1,k</sub>			R <sub>2,k</sub> = R <sub>3,k</sub>			R <sub>4,k</sub>			R <sub>5,k</sub>				
		4,0x35	4,0x40	4,0x60	4,0x35	4,0x40	4,0x60	4,0x35	4,0x40	4,0x60	4,0x35	4,0x40	4,0x60		
Maximum nailing: 8+10 See fig. D11-2	P	Connector nail according to ETA-04/0013:													
		≤ 27: <u>63</u> f+40	≤ 32: <u>69</u> f+40	≤ 46: <u>90</u> f+40	2,8	3,1	3,9	≤ 10: 6,0	≤ 10: 6,6	≤ 10: 8,5	≤ 51:	≤ 50:	≤ 48:		
		f > 27: <u>26,5</u> f+1	f > 32: <u>31,8</u> f+1	f > 46: <u>49,4</u> f+1				10 < e ≤ 145: <u>60</u> e	10 < e ≤ 120: <u>65</u> e	10 < e ≤ 70: <u>84</u> e	51 < e ≤ 1,18·b+14: 2,8	50 < e ≤ 1,09·b+16: 3,1	48 < e ≤ 0,89·b+20: 4,6		
								e > 145: <u>49</u> e-29	e > 120: <u>49</u> e-29	e > 70: <u>49</u> e-29	e > 1,18·b+14: <u>3,3-b-140</u> e-65	e > 1,09·b+16: <u>3,4-b-153</u> e-65	e > 0,89·b+20: <u>4,1-b-204</u> e-65		
	L	≤ 32: <u>68</u> f+40	≤ 38: <u>74</u> f+40	≤ 38: <u>99</u> f+40	3,3	3,6	4,6	≤ 9: 7,0	≤ 9: 7,7	≤ 9: 9,9	≤ 50:	≤ 49:	≤ 47:		
		f > 32: <u>30,9</u> f+1	f > 38: <u>37</u> f+1	f > 38: <u>49,4</u> f+1				9 < e ≤ 130: <u>64</u> e	9 < e ≤ 100: <u>70</u> e	9 < e ≤ 62: <u>91</u> e	50 < e ≤ 1,11·b+16: 3,1	49 < e ≤ 1,03·b+18: 3,5	47 < e ≤ 0,84·b+21: 5,2		
								e > 130: <u>49</u> e-29	e > 100: <u>49</u> e-29	e > 62: <u>49</u> e-29	e > 1,11·b+16: <u>3,4-b-151</u> e-65	e > 1,03·b+18: <u>3,6-b-166</u> e-65	e > 0,84·b+21: <u>4,4-b-226</u> e-65		
	M	≤ 36: <u>72</u> f+40	≤ 44: <u>79</u> f+40	≤ 32: <u>107</u> f+40	3,8	4,1	5,2	≤ 8: 8,0	≤ 8: 8,8	≤ 9: 11,3	≤ 50:	≤ 49:	≤ 47:		
		f > 36: <u>35,3</u> f+1	f > 44: <u>42,3</u> f+1	f > 32: <u>49,4</u> f+1				8 < e ≤ 105: <u>68</u> e	8 < e ≤ 85: <u>74</u> e	9 < e ≤ 57: <u>99</u> e	50 < e ≤ 1,05·b+17: 3,4	49 < e ≤ 0,97·b+19: 3,9	47 < e ≤ 0,80·b+22: 5,8		
								e > 105: <u>49</u> e-29	e > 85: <u>49</u> e-29	e > 57: <u>49</u> e-29	e > 1,05·b+17: <u>3,5-b-162</u> e-65	e > 0,97·b+19: <u>3,8-b-179</u> e-65	e > 0,80·b+22: <u>4,6-b-247</u> e-65		
	S	≤ 41: <u>77</u> f+40	≤ 49: <u>84</u> f+40	≤ 28: <u>116</u> f+40	4,2	4,7	5,9	≤ 8: 9,1	≤ 8: 9,9	≤ 8: 12,8	≤ 49:	≤ 48:	≤ 47:		
f > 41: <u>39,7</u> f+1		f > 49: <u>47,6</u> f+1	f > 28: <u>49,4</u> f+1	8 < e ≤ 92: <u>72</u> e				8 < e ≤ 77: <u>79</u> e	8 < e ≤ 56: <u>101</u> e	49 < e ≤ 1,00·b+18: 3,7	48 < e ≤ 0,93·b+20: 4,2	47 < e ≤ 0,77·b+23: 6,4			
				e > 92: <u>49</u> e-29				e > 77: <u>49</u> e-29	e > 56: <u>49</u> e-29	e > 1,00·b+18: <u>3,7-b-173</u> e-65	e > 0,93·b+20: <u>3,9-b-192</u> e-65	e > 0,77·b+23: <u>4,9-b-268</u> e-65			
I	≤ 50: <u>85</u> f+40	≤ 41: <u>95</u> f+40	≤ 22: <u>134</u> f+40	5,2	5,7	7,2	≤ 7: 11,1	≤ 7: 12,1	≤ 6: 15,6	≤ 48:	≤ 48:	≤ 46:			
	f > 50: <u>48,5</u> f+1	f > 41: <u>49,4</u> f+1	f > 22: <u>49,4</u> f+1				7 < e ≤ 75: <u>80</u> e	7 < e ≤ 65: <u>88</u> e	6 < e ≤ 56: <u>101</u> e	48 < e ≤ 0,92·b+20: 4,3	48 < e ≤ 0,86·b+21: 4,9	46 < e ≤ 0,72·b+24: 7,6			
							e > 75: <u>49</u> e-29	e > 65: <u>49</u> e-29	e > 56: <u>49</u> e-29	e > 0,92·b+20: <u>3,9-b-194</u> e-65	e > 0,86·b+21: <u>4,2-b-217</u> e-65	e > 0,72·b+24: <u>5,4-b-311</u> e-65			

f, e and b are in mm.

Wane may not occur under the angle bracket

Table D11-5 1 angle bracket ABR9020, beam to beam connection – minimum nailing - connector nails

1 Angle Bracket ABR9020 per connection		Modified characteristic capacity per connection (kN)														
Nailing	Load duration	R <sub>1,k</sub>			R <sub>2,k</sub> = R <sub>3,k</sub>			R <sub>4,k</sub>			R <sub>5,k</sub>					
		Connector nail according to ETA-04/0013:						4,0x35	4,0x40	4,0x60	4,0x35	4,0x40	4,0x60	4,0x35	4,0x40	4,0x60
Minimum nailing: 4+6 See fig. D11-3	P	≤ 27:	≤ 33:	≤ 46:	1,8	1,9	2,4	≤ 30: 2,0	≤ 29: 2,2	≤ 29: 2,8	≤ 55:	≤ 55:	≤ 53:			
		63 f+40	69 f+40	90 f+40				30<e≤ 150:	29<e≤ 120:	29<e≤ 70:	26,5 65-e	31,8 65-e	52,9 65-e			
		60 e	65 e	84 e				55<e≤ 1,18·b+2:	55<e≤ 1,09·b+3:	53<e≤ 0,89·b+5:	2,8	3,1	4,6			
		e>150:	e>120:	e>70:				e>1,18·b+2:	e>1,09·b+3:	e>0,89·b+5:	49 e-29	49 e-29	49 e-29	3,3·b-176 e-65	3,4·b-196 e-65	4,1·b-275 e-65
		f>27:	f>33:	f>46:							26,5 f+1	31,8 f+1	49,4 f+1			
	L	≤ 32:	≤ 38:	≤ 38:	2,1	2,2	2,9	≤ 27: 2,3	≤ 27: 2,6	≤ 28: 3,3	≤ 55:	≤ 54:	≤ 53:			
		68 f+40	74 f+40	99 f+40				27<e≤ 120:	27<e≤ 97:	28<e≤ 62:	30,9 65-e	37,0 65-e	61,7 65-e			
		64 e	70 e	91 e				55<e≤ 1,11·b+3:	54<e≤ 1,03·b+3:	53<e≤ 0,84·b+5:	3,1	3,5	5,2			
		e>120:	e>97:	e>62:				e>1,11·b+3:	e>1,03·b+3:	e>0,84·b+5:	49 e-29	49 e-29	49 e-29	3,4·b-192 e-65	3,6·b-215 e-65	4,4·b-308 e-65
		f>32:	f>38:	f>38:							30,9 f+1	37,0 f+1	49,4 f+1			
	M	≤ 36:	≤ 44:	≤ 32:	2,4	2,6	3,3	≤ 25: 2,7	≤ 25: 2,9	≤ 26: 3,8	≤ 55:	≤ 54:	≤ 53:			
		72 f+40	79 f+40	107 f+40				25<e≤ 105:	25<e≤ 85:	26<e≤ 57:	35 65-e	42,0 65-e	71,0 65-e			
		68 e	74 e	99 e				55<e≤ 1,05·b+3:	54<e≤ 0,97·b+4:	53<e≤ 0,80·b+6:	3,4	3,9	5,8			
		e>105:	e>85:	e>57:				e>1,05·b+3:	e>0,97·b+4:	e>0,80·b+6:	49 e-29	49 e-29	49 e-29	3,5·b-209 e-65	3,8·b-235 e-65	4,6·b-341 e-65
		f>36:	f>44:	f>32:							35,3 f+1	42,3 f+1	49,4 f+1			
	S	≤ 41:	≤ 49:	≤ 28:	2,7	2,9	3,7	≤ 24: 3,0	≤ 24: 3,3	≤ 24: 4,3	≤ 54:	≤ 54:	≤ 53:			
		77 f+40	84 f+40	116 f+40				24<e≤ 92:	24<e≤ 77:	24<e≤ 56:	40 65-e	48,0 65-e	79,0 65-e			
72 e		79 e	101 e	54<e≤ 1,00·b+4:				54<e≤ 0,93·b+4:	53<e≤ 0,77·b+6:	3,7	4,2	6,4				
e>92:		e>77:	e>56:	e>1,00·b+4:				e>0,93·b+4:	e>0,77·b+6:	49 e-29	49 e-29	49 e-29	3,7·b-225 e-65	3,9·b-255 e-65	4,9·b-374 e-65	
f>41:		f>49:	f>28:							39,7 f+1	47,6 f+1	49,4 f+1				
I	≤ 50:	≤ 41:	≤ 22:	3,2	3,5	4,5	≤ 22: 3,7	≤ 22: 4,0	≤ 19: 5,2	≤ 54:	≤ 53:	≤ 52:				
	85 f+40	95 f+40	134 f+40				22<e≤ 75:	22<e≤ 65:	19<e≤ 56:	49 65-e	58,0 65-e	97,0 65-e				
	80 e	88 e	101 e				54<e≤ 0,92·b+5:	53<e≤ 0,86·b+5:	52<e≤ 0,72·b+7:	4,3	4,9	7,6				
	e>75:	e>65:	e>56:				e>0,92·b+5:	e>0,86·b+5:	e>0,72·b+7:	49 e-29	49 e-29	49 e-29	3,9·b-259 e-65	4,2·b-295 e-65	5,4·b-441 e-65	
	f>50:	f>41:	f>22:							48,5 f+1	49,4 f+1	49,4 f+1				

f, e and b are in mm.

**Characteristic capacities:**

Table D11-6 2 angle brackets ABR9020, timber beam to 6 mm steel beam connection – connector nails + PAT pins

2 Angle Brackets ABR9020 per connection	Characteristic capacity per connection [kN]
Nailing	R <sub>1,k</sub>
8 CNA4,0x60 + 4 PDPA-75 See fig. D11-4	12,1

Connector nails according to ETA-04/0013

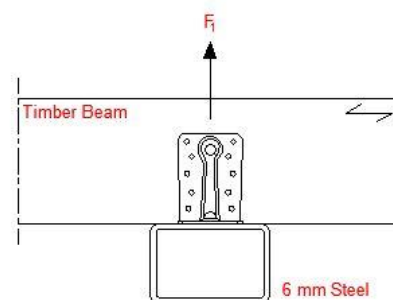
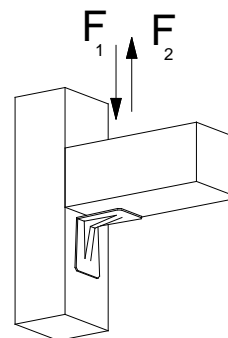

Table D11-7 1 angle brackets ABR9020, beam to column

modified characteristic capacity per connection [kN]

	R <sub>1,k</sub>		R <sub>2,k</sub>	
	4,0x40	4,0x60	4,0x40	4,0x60
	Nailing 4+10 see fig. 11-5	7,7	10,4	1,5



**Annex D12 – ABR100**

**Product Name:**

Product Name	Alternative name			
	UK	France	Denmark	Germany
ABR100	--	--	--	--

**Drawing:**

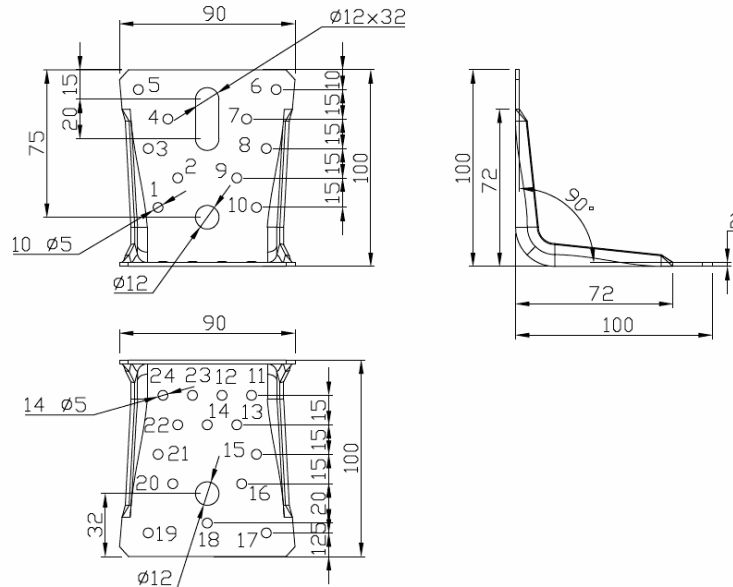

Figure D12-1 - ABR100

**Material:**

Standard material : S250GD + Z275 according to EN 10346

Or stainless steel according to clause II-1

**Nail pattern:**

Beam to beam connection

Beam to rigid support connection

Beam to steel (6 mm S355) connection

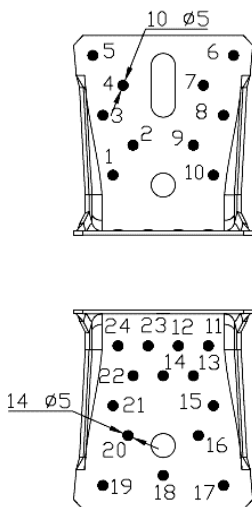

Figure D12-2  
10 nails in vertical flap  
14 nails in the horizontal flap

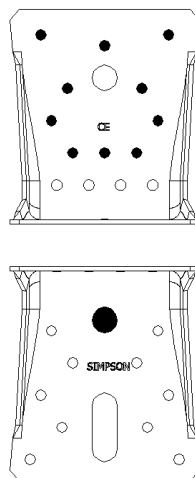

Figure D12-3  
10 nails in vertical flap  
1 bolt in the horizontal flap

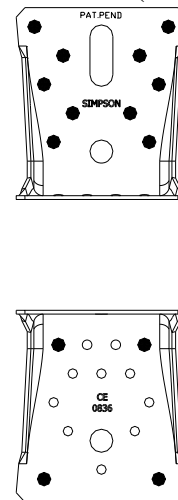

Figure D12-4  
10 CNA4,0x60 nails in vertical flap  
4 PDPA-75 nails in the horizontal flap

**Modified characteristic capacities:**

Table D12-1 2 angle brackets ABR100, beam to beam connection - connector screws

K<sub>modi</sub> = 1.18

<b>ABR100</b>		<b>2 Angle Brackets per connection Timber to timber connection with screws</b>					
		<b>Modified characteristic capacity per connection (kN)</b>					
Nailing	Load duration	<b>R<sub>1,k</sub></b>			<b>R<sub>2,k</sub> = R<sub>3,k</sub></b>		
		Connector screws according to ETA-04/0013					
		5,0x35	5,0x40	5,0x50	5,0x35	5,0x40	5,0x50
<b>Maximum</b> Vertical flap: 10 screws Horizontal flap: 14 screws See fig. D12-2	P	11,8	15,5	--	9,6	12,2	--
	L	13,8	18,1	--	11,2	14,2	--
	M	15,8	20,7	--	12,8	16,3	--
	S	17,7	22,4	--	14,4	18,3	--
	I	21,5	25,1	--	17,6	22,4	--

Characteristic loads for CSA 5.0x50 have not been evaluated. You can considered capacities for CSA5.0x40 in a safe way. Moreover, wane may not occur under the angle brackets.

Table D12-2 1 angle bracket ABR100, beam to beam connection - connector screws

<b>ABR100</b>		<b>1 Angle Brackets per connection - Timber to timber connection with screws</b>					
		<b>Modified characteristic capacity per connection (kN)</b>					
Nailing	Load duration	<b>R<sub>1,k</sub></b>			<b>R<sub>2,k</sub> = R<sub>3,k</sub></b>		
		Connector screws according to ETA-04/0013					
		5,0x35	5,0x40	5,0x50	5,0x35	5,0x40	5,0x50
<b>Maximum</b>	P	f ≤ 43 : $\frac{193}{f + 55,5}$	f ≤ 29 : $\frac{247}{f + 55,5}$	--	4,8	6,1	--
		f > 43 : $\frac{84}{f}$	f > 29 : $\frac{84}{f}$				
	L	f ≤ 34 : $\frac{222}{f + 55,5}$	f ≤ 19 : $\frac{285}{f + 55,5}$ 19 < f ≤ 26 : $\frac{141}{f + 18}$	--	5,6	7,1	--
		f > 34 : $\frac{84}{f}$	f > 26 : $\frac{84}{f}$				
	Vertical flap: 10 screws	M	f ≤ 28 : $\frac{251}{f + 55,5}$	f ≤ 11 : $\frac{323}{f + 55,5}$ 11 < f ≤ 26 : $\frac{141}{f + 18}$	--	6,4	8,1
Horizontal flap: 14 screws	f > 28 : $\frac{84}{f}$		f > 26 : $\frac{84}{f}$				
See fig. D12-2	S	f ≤ 24 : $\frac{279}{f + 55,5}$	f ≤ 7 : $\frac{361}{f + 55,5}$ 7 < f ≤ 26 : $\frac{141}{f + 18}$	--	7,2	9,2	--
	I	f ≤ 9 : $\frac{337}{f + 55,5}$ 9 < f ≤ 26 : $\frac{141}{f + 18}$	f ≤ 26 : $\frac{141}{f + 18}$				
		f > 26 : $\frac{84}{f}$	f > 26 : $\frac{84}{f}$				

Characteristic loads for CSA5.0x50 have not been evaluated. You can considered capacities for CSA5.0x40 in a safe way. Moreover, wane may not occur under the angle brackets.



**Characteristic capacities:***Table D12-3 2 angle brackets ABR100, beam to beam connection - connector nails*

2 ABR100 per connection	characteristic capacity in [kN]							
	R <sub>1,k</sub>				R <sub>2/3,k</sub>			
nailing	connector nails according ETA-04/0013							
	4,0x35	4,0x40	4,0x50	4,0x60	4,0x35	4,0x40	4,0x50	4,0x60
vertical:10 nails + horizontal14 nails	9,7	11,7	15,7	19,7	9,6	12,8	14,2	16,7
	R <sub>4/5,k</sub>							
e [mm]=	4,0x35	4,0x40	4,0x50	4,0x60				
0	14,19	15,45	16,10	16,76				
20	11,55	13,71	18,04	19,18				
50	8,20	8,93	10,38	10,99				
100	2,40	4,20	5,14	5,14				
150	0,83	2,15	2,73	2,94				

Wane may not occur under the angle brackets.

*Table D12-4 1 angle bracket ABR100, beam to beam connection - connector nails*

1 ABR100 per connection	characteristic capacity in [kN]							
	R <sub>1,k</sub>				R <sub>2/3,k</sub> *			
nailing	connector nails according to ETA-04/0013							
	4,0x35	4,0x40	4,0x50	4,0x60	4,0x35	4,0x40	4,0x50	4,0x60
maximum nailing: vertical:10 nails + horizontal14 nails	a=140	a = 164	a = 212	a = 256	4,8    6,4    7,1    8,3			
	$\min \left\{ \begin{array}{l} \frac{a}{f + 56} \\ \frac{121}{(f + 18) \times k_{\text{mod}}} \\ \frac{84}{f \times k_{\text{mod}}} \end{array} \right.$							
e [mm]=	R <sub>4,k</sub>				R <sub>5,k</sub>			
0	12,55	12,55	12,55	12,55	1,64	1,97	2,62	3,28
20	8,70	10,29	12,55	12,55	2,85	3,42	4,56	5,70
50	3,70	4,43	5,22	5,51	4,50	4,50	4,50	4,50
100	0,77/k <sub>mod</sub>				1,63	1,96	2,25	2,25
150	0,29/k <sub>mod</sub>				0,54	0,65	0,87	1,09

\*the timber is prevented from rotation

Wane may not occur under the angle brackets.

**Modified characteristic capacities:**

Table D12-5 ABR100, beam to rigid support connection

2 Angle Brackets ABR100 per connection		Modified characteristic capacity in [kN]						
		R <sub>1,k</sub>			R <sub>2/3,k</sub>			R <sub>4/5,k</sub>
		connector nails according ETA-04/0013						
nailing	load duration	4,0x40	4,0x50	4,0x60	4,0x40	4,0x50	4,0x60	size 4,0x40 to 4,0x60
vertical: 10 nails + horizontal 1 bolt M10	P	12,4	16,0	18,7	5,2	6,5	7,4	6,24 *1)
	L	14,5	18,6	21,6	6,1	7,6	8,6	7,28 *1)
	M	16,5	21,3	21,6	6,9	8,7	9,8	8,32 *1)
	S	18,6	21,6	21,6	7,8	9,8	11,1	9,36 *1)
	I	21,6	21,6	21,6	9,5	12,0	13,5	11,44 *1)

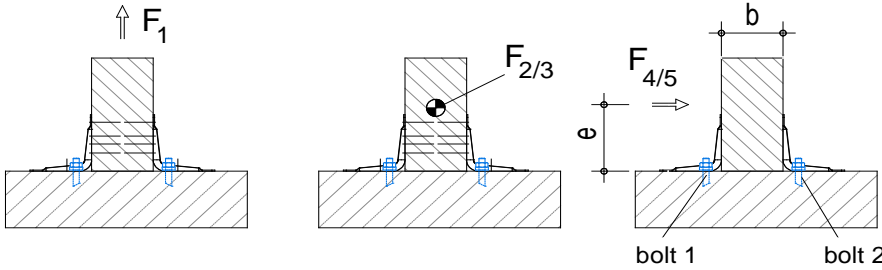

\*1) to be checked:  
 the bolt 1:  $R_{\text{bolt,ax,d}} \geq F_{4/5,d} \times e / b$   
 the bolt 2:  $R_{\text{bolt,lat,d}} \geq F_{4/5,d}$   
 and:  $R_{4/5,d} \leq R_{1,d} \times b / (2xe)$   
 for R<sub>1</sub>:  $R_{\text{bolt,ax,d}} \geq F_{1,d} / 2$   
 for R<sub>2/3</sub>:  $R_{\text{bolt,lat,d}} \geq F_{2/3,d} / 2$

**Characteristic capacities:**

*Table D12-6 ABR100, beam to rigid support connection*

1 Angle Brackets ABR100 per connection  nailing	characteristic capacity in [kN]						
	$R_{1,k}$	$R_{2,k}$	$R_{4,k}$ *3)		$R_{5,k}$ *3)		
	connector nails according ETA-04/0013 size 4,0x40 to 4,0x60						
vertical: 10 nails + horizontal 1 bolt M10	$R_{1,k} = \min \left\{ \begin{array}{l} \frac{22,45}{f^{0,7} \times k_{mod}} \\ 4,49 \\ k_{mod} \end{array} \right.$	*2)	e [mm]	steel	timber	steel	timber
			0				2,3
			20				4,5
			50	4,6	9,0	4,5	8,4
			100	0,8		2,3	1,8
			150	0,3		1,5	0,6

\*2) If the timber is prevented from turn away, half the capacity of 2 ABR100 can be used the values for timber may be to use with  $k_{mod}$ , the values for steel allways with  $k_{mod} = 1$  the minimum of both are available

\*3) bolt checks:  
 $R_{bolt,ax,d} \geq F_{4 \text{ or } 5,d} \times e / 40$   
 $R_{bolt,lat,d} \geq F_{4 \text{ or } 5,d}$

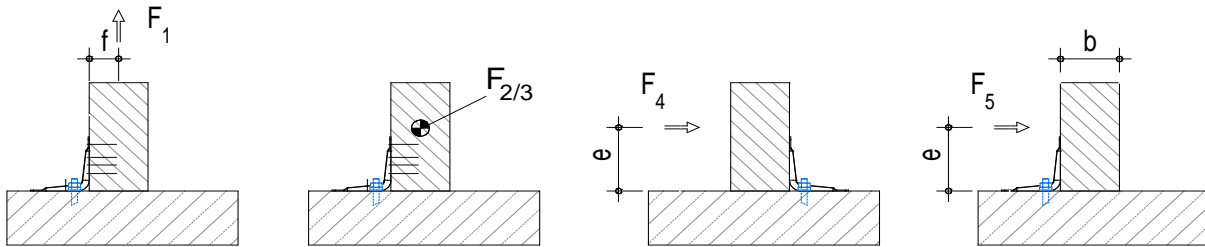

$$R_{i,d} = \frac{R_{i,k} \times k_{mod}}{\gamma_M}$$

$R_{i,k}$  is the table-value,  $\gamma_M$  is always the value for timber

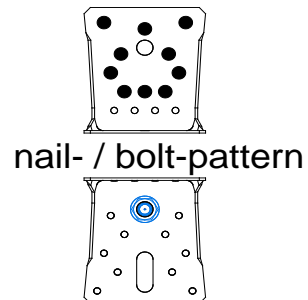

*Table D12-7 2 angle brackets ABR100, timber beam to 6 mm steel beam connection – connector nails + PAT pins*

2 Angle Brackets ABR100 per connection	Characteristic capacity per connection [kN]
Nailing	$R_{1,k}$
10 CNA4,0x60 + 4 PDPA-75 See fig. D12-4	21,5

Connector nails according to ETA-04/0013

**Annex D13 – AA60280**

**Product Name:**

Product Name	Alternative name			
	UK	France	Denmark	Germany
AA60280	--	--	--	--

**Drawing:**

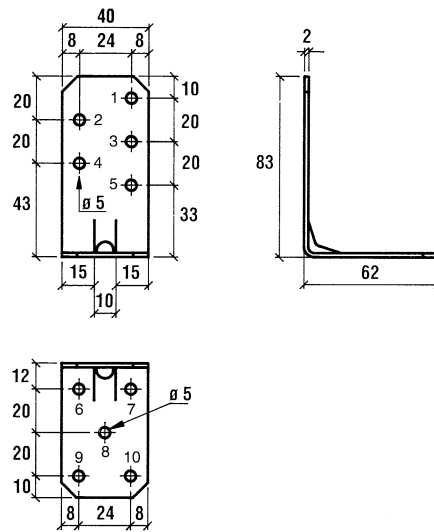

Figure D13-1 - AA60280

**Material:**

Standard material : S250GD + Z275 according to EN 10346

Or stainless steel according to clause II-1

**Nail pattern:**

Beam to beam connection

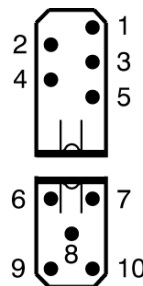

Figure D13-2  
5 nails in vertical flap  
5 nails in the horizontal flap

**Modified characteristic capacities:**

Table D13-1 AA60280, beam to beam connection - connector nails

2 Angle Brackets per connection	Characteristic capacity per connection (kN)					
	$R_{1,k}$		$R_{2,k} = R_{3,k}$		$R_{4,k} = R_{5,k}$	
Load duration	Connector nail according to ETA-04/0013					
	4,0x40	4,0x60	4,0x40	4,0x60	4,0x40	4,0x60
Full nailing						
S	2,6	4,0	3,7	5,5	e ≤ 0,40b+14: 3,2 e > 0,40b+14: <u>1.32b+36</u> e-2,0	e ≤ 0,70b+19: 3,2 e > 0,70b+19: <u>2.21b+52</u> e-2,0
M	2,3	3,6	3,3	4,9	e ≤ 0,40b+14: 3,0 e > 0,40b+14: <u>1.18b+33</u> e-2,0	e ≤ 0,66b+19: 3,0 e > 0,66b+19: <u>1.96b+47</u> e-2,0

b and e are in mm

Factors for other load durations	$R_{1,k}$		$R_{2,k} = R_{3,k}$		$R_{4,k} = R_{5,k}$	
	Connector nail according to ETA-04/0013					
	4,0x40	4,0x60	4,0x40	4,0x60	4,0x40	4,0x60
I multiply S by	1,19	1,20	1,22	1,22	1,10	1,10
L multiply M by	0,88	0,89	0,88	0,88	0,89	0,88
P multiply M by	0,75	0,78	0,75	0,75	0,77	0,76

Table D13-2 AA60280, beam to beam connection - connector nails

1 Angle Bracket per connection	Characteristic capacity per connection (kN)			
	$R_{1,k}$ Purlin may rotate		$R_{2,k} = R_{3,k}$	
Load duration	Connector nail according to ETA-04/0013			
	4,0x40	4,0x60	4,0x40	4,0x60
Full nailing				
P	min: $\frac{37}{f + 52}$ $\frac{12}{f + 10}$	$\frac{12}{f + 10}$	1,2	1,8
L	min: $\frac{43}{f + 52}$ $\frac{12}{f + 10}$	$\frac{12}{f + 10}$	1,4	2,1
M	$\frac{12}{f + 10}$	$\frac{12}{f + 10}$	1,7	2,4
S	$\frac{12}{f + 10}$	$\frac{12}{f + 10}$	1,9	2,7
I	$\frac{12}{f + 10}$	$\frac{12}{f + 10}$	2,3	3,3

f is in mm

**Annex D14 – ABB40390**

**Product Name:**

Product Name	Alternative name			
	UK	France	Denmark	Germany
ABB40390	--	--	--	--
ABB40390S	--	--	--	--
ABB40390S2	--	--	--	--

**Drawing:**

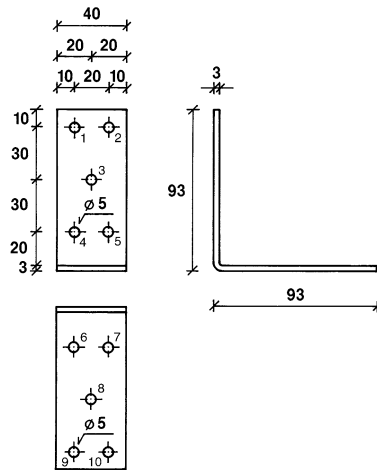

Figure D14-1 - ABB40390

**Material:**

Standard material : S250GD + Z275 according to EN 10346  
 Or stainless steel according to clause II-1

**Nail pattern:**

Beam to beam connection

Figure D14-2

Minimum nailing:  
 3 nails in vertical flap  
 5 nails in the horizontal flap

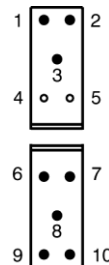
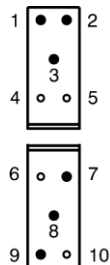

Figure D14-3

Maximum nailing:  
 3 nails in vertical flap  
 3 nails in the horizontal flap

**Modified characteristic capacities:**

Table D14-1 ABB40390, beam to beam connection - connector nails

2 Angle Brackets per connection	Modified characteristic capacity per connection (kN)					
	R <sub>1,k</sub>		R <sub>2,k</sub> = R <sub>3,k</sub>		R <sub>4,k</sub> = R <sub>5,k</sub>	
Load duration	Connector nail according to ETA-04/0013					
	4,0x40	4,0x60	4,0x40	4,0x60	4,0x40	4,0x60
<b>Minimum nailing: 3+3 (fig. D14-2)</b>						
S	1,9	2,8	1,5	2,0	e ≤ 0,21b+14: 4,5 e > 0,21b+14: <u>0,96b+48</u> e-3,0	e ≤ 0,30b+15: 4,6 e > 0,30b+15: <u>1,38b+57</u> e-3,0
M	1,8	2,5	1,4	1,8	e ≤ 0,24b+16: 3,6 e > 0,24b+16: <u>0,88b+46</u> e-3,0	e ≤ 0,29b+16: 4,3 e > 0,29b+16: <u>1,26b+54</u> e-3,0
<b>Maximum nailing: 3+5 (fig. D14-3)</b>						
S	2,7	4,4	1,8	2,5	e ≤ 0,32b+16: 4,5 e > 0,32b+16: <u>1,46b+59</u> e-3,0	e ≤ 0,49b+19: 4,6 e > 0,49b+19: <u>2,22b+75</u> e-3,0
M	2,4	3,9	1,6	2,2	e ≤ 0,37b+18: 3,6 e > 0,37b+18: <u>1,34b+56</u> e-3,0	e ≤ 0,47b+19: 4,3 e > 0,47b+19: <u>2,01b+71</u> e-3,0

b and e are in mm

Factors for other load durations	R <sub>1,k</sub>		R <sub>2,k</sub> = R <sub>3,k</sub>		R <sub>4,k</sub> = R <sub>5,k</sub>	
	Connector nail according to ETA-04/0013					
	4,0x40	4,0x60	4,0x40	4,0x60	4,0x40	4,0x60
I multiply S by	1,15	1,00	1,22	1,22	1,10	1,06
L multiply M by	0,88	0,88	0,88	0,88	0,84	0,90
P multiply M by	0,75	0,75	0,75	0,75	0,78	0,80



Table D14-2 ABB40390, beam to beam connection - connector nails

1 Angle Bracket per connection	Modified characteristic capacity per connection (kN)			
	R <sub>1,k</sub> Upper member may rotate		R <sub>2,k</sub> = R <sub>3,k</sub>	
Load duration	Connector nail according to ETA-04/0013			
	4,0x40	4,0x60	4,0x40	4,0x60
<b>Minimum nailing: 3+3 (fig. D14-2)</b>				
P	$\frac{14}{f + 53}$	min: $\frac{24}{f + 53}$ $\frac{20}{f + 21}$	0,5	0,7
L	$\frac{17}{f + 53}$	min: $\frac{28}{f + 53}$ $\frac{20}{f + 21}$	0,6	0,8
M	$\frac{19}{f + 53}$	min: $\frac{31}{f + 53}$ $\frac{20}{f + 21}$	0,7	0,9
S	min: $\frac{21}{f + 53}$ $\frac{20}{f + 21}$	min: $\frac{35}{f + 53}$ $\frac{20}{f + 21}$	0,8	1,0
I	min: $\frac{26}{f + 53}$ $\frac{20}{f + 21}$	min: $\frac{43}{f + 53}$ $\frac{20}{f + 21}$	0,9	1,2

Table D14-3 ABB40390, beam to beam connection - connector nails

1 Angle Bracket per connection	Modified characteristic capacity per connection (kN)			
	$R_{1,k}$ Upper member may rotate		$R_{2,k} = R_{3,k}$	
Load duration	Connector nail according to ETA-04/0013			
	4,0x40	4,0x60	4,0x40	4,0x60
<b>Maximum nailing: 3+5 (fig. D14-3)</b>				
P	min: <u>28</u> f + 53 <u>20</u> f + 21	<u>20</u> f + 21	0,6	0,8
L	min: <u>33</u> f + 53 <u>20</u> f + 21	<u>20</u> f + 21	0,7	1,0
M	<u>20</u> f + 21	<u>20</u> f + 21	0,8	1,1
S	<u>20</u> f + 21	<u>20</u> f + 21	0,9	1,2
I	<u>20</u> f + 21	<u>20</u> f + 21	1,1	1,5

**Annex D15 – AE48**

**Product Name:**

Product Name	Alternative name			
	UK	France	Denmark	Germany
AE48	--	EB/7048	--	--

**Drawing:**

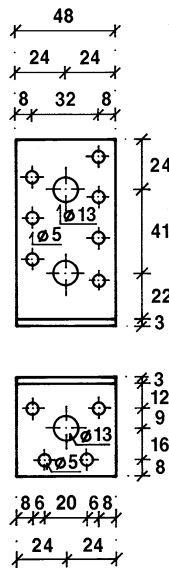

Figure D15-1 - AE48

**Material:**

Standard material : S250GD + Z275 according to EN 10346

Or stainless steel according to clause II-1

**Nail pattern:**

Beam to beam connection

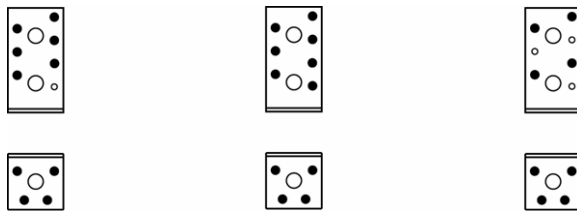

Figure D15-2

- a) Max. nailing with force  $F_1$ ,  $F_4$  and  $F_5$
- b) Max./full nailing with force  $F_2$  and  $F_3$
- c) Min. nailing

Beam to rigid connection

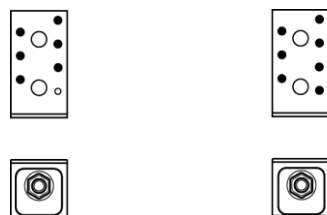

Figure D15-3

- a) Max. nailing with force  $F_1$ ,  $F_4$  and  $F_5$
- b) Max./full nailing with force  $F_2$  and  $F_3$

For a force only in direction  $F_2$  it's allowed to use the washer of the used anchor bolt instead of the square washers US40/40/10G or US40/50/10G

- a)
- b)

**Modified characteristic capacities:**

Table D15-1 AE48 - beam to beam connection - connector nails

2 Angle Brackets per connection	Modified characteristic capacity per connection (kN)					
	$R_{1,k}$		$R_{2,k} = R_{3,k}$		$R_{4,k} = R_{5,k}$	
Number of Nails	Connector nail according to ETA-04/0013					
	4,0x40	4,0x60	4,0x40	4,0x60	4,0x40	4,0x60
<b>Load duration: S</b>						
Minimum (fig. D15-2 c)	2,6	4,4	3,6	4,9	min: 4,2	min: 5,3
Maximum (fig. D15-2 a+b)			3,6	5,4	$\frac{1,32b+41}{e-3,0}$	$\frac{2,21b+47}{e-3,0}$
<b>Load duration: M</b>						
Minimum (fig. D15-2 c)	2,4	3,9	3,2	4,4	min: 3,9	min: 4,0
Maximum (fig. D15-2 a+b)			3,2	4,8	$\frac{1,18b+40}{e-3,0}$	$\frac{1,96b+46}{e-3,0}$

b and e are in mm

Factors for other load durations	$R_{1,k}$		$R_{2,k} = R_{3,k}$		$R_{4,k} = R_{5,k}$	
	Connector nail according to ETA-04/0013					
	4,0x40	4,0x60	4,0x40	4,0x60	4,0x40	4,0x60
I multiply S by	1,22	1,22	1,22	1,22	1,11	1,11
L multiply M by	0,88	0,88	0,88	0,88	0,88	0,88
P multiply M by	0,75	0,75	0,75	0,75	0,77	0,77

Table D15-2 AE48 - beam to beam connection - connector nails

1 Angle Bracket per connection	Modified characteristic capacity per connection (kN)			
	$R_{1,k}$ Purlin may rotate		$R_{2,k} = R_{3,k}$	
Number of Nails	Connector nail according to ETA-04/0013			
	4,0x40	4,0x60	4,0x40	4,0x60
<b>Load duration: S</b>				
Minimum (fig. D15-2 c)	min: $\frac{36}{f+40}$	min: $\frac{60}{f+40}$	1,8	2,5
Maximum (fig. D15-2 a+b)	$\frac{25}{f+13}$	$\frac{25}{f+13}$	1,8	2,7
<b>Load duration: M</b>				
Minimum (fig. D15-2 c)	min: $\frac{32}{f+40}$	min: $\frac{53}{f+40}$	1,6	2,2
Maximum (fig. D15-2 a+b)	$\frac{25}{f+13}$	$\frac{25}{f+13}$	1,6	2,4

b and e are in mm

Factors for other load durations	$R_{1,k}$ Purlin may rotate		$R_{2,k} = R_{3,k}$	
	Connector nail according to ETA-04/0013			
	4,0x40	4,0x60	4,0x40	4,0x60
I multiply S by	1,00	1,00	1,22	1,22
L multiply M by	0,88	0,88	0,88	0,88
P multiply M by	0,75	0,75	0,75	0,75

Table D15-3

AE48, beam to rigid support connection - connector nails

2 Angle Brackets per connection	Modified characteristic capacity per connection (kN)					
	$R_{1,k}$		$R_{2,k} = R_{3,k}$		$R_{4,k} = R_{5,k}$	
Number of Nails in vertical flap / 1 bolt in horizontal flap	Connector nail according to ETA-04/0013					
	4,0x40	4,0x60	4,0x40	4,0x60	4,0x40	4,0x60
<b>Load duration: S</b>						
Maximum (fig. D15-3 a+b)	6,6	10,6	1,9	3,2	$\frac{6,28b+76}{e-3,0}$	$\frac{6,28b+76}{e-3,0}$
	12,6	12,6			max: 4,2	max: 4,9
<b>Load duration: M</b>						
Maximum (fig. D15-3 a+b)	5,9	9,5	1,7	2,8	$\frac{5,95b+73}{e-3,0}$	$\frac{6,28b+76}{e-3,0}$
	11,9	12,6			max: 3,9	max: 3,9

b and e are in mm

When the purlin has a wane on the side towards the Angle Bracket the value in the grey square is valid.

Factors for other load durations	$R_{1,k}$		$R_{2,k} = R_{3,k}$		$R_{4,k} = R_{5,k}$	
	Connector nail according to ETA-04/0013					
	4,0x40	4,0x60	4,0x40	4,0x60	4,0x40	4,0x60
I multiply S by	1,22	1,00	1,22	1,22	1,00	1,00
	1,00	1,00				
L multiply M by	0,88	0,87	0,88	0,88	0,88	0,90
	0,88	1,00				
P multiply M by	0,75	0,75	0,75	0,75	0,76	0,78
	0,88	1,00				

AE48	connection with 2 angle brackets			
factor:	for $F_1$	for $F_{2/3}$	for $F_{4/5, \text{bolt 1}}$	for $F_{4/5, \text{bolt 2}}$
$k_{ax}$	0,62	-	$1,24 \times e/(b+7)$	-
$k_{lat}$	-	0,50	-	1,00

For each bolt it's needed to check:  $R_{\text{bolt},d,\text{lateral}} \geq k_{\text{lat}} \times F_{i,d}$  ;  $R_{\text{bolt},d,\text{axial}} \geq k_{\text{ax}} \times F_{i,d}$  ; and also the combination

Table D15-4

AE48, beam to rigid support connection - connector nails

1 Angle Bracket per connection	Modified characteristic capacity per connection (kN)			
	$R_{1,k}$ Purlin may rotate		$R_{2,k} = R_{3,k}$	
Number of Nails in vertical flap / 1 bolt in horizontal flap	Connector nail according to ETA-04/0013			
	4,0x40	4,0x60	4,0x40	4,0x60
<b>Load duration: S</b>				
Maximum (fig. D15-3 a+b)	$\frac{20}{f+9}$	$\frac{20}{f+9}$	1,0	1,6
<b>Load duration: M</b>				
Maximum (fig. D15-3 a+b)	$\frac{20}{f+9}$	$\frac{20}{f+9}$	0,9	1,4

f is in mm

Factors for other load durations	$R_{1,k}$		$R_{2,k} = R_{3,k}$	
	Connector nail according to ETA-04/0013			
	4,0x40	4,0x60	4,0x40	4,0x60
I multiply S by	1,00	1,00	1,22	1,22
L multiply M by	1,00	1,00	0,88	0,88
P multiply M by	1,00	1,00	0,75	0,75

AE48	connection with 1 angle brackets			
factor:	for $F_1$	for $F_{2/3}$	for $F_4$	for $F_5$
$k_{ax}$	$(f+48)/27$	2,08	-	-
$k_{lat}$	-	1,00	-	-

For each bolt it's needed to check:  $R_{bolt,d,lateral} \geq k_{lat} \times F_{i,d}$  ;  $R_{bolt,d,axial} \geq k_{ax} \times F_{i,d}$  ; and also the combination

**Annex D16 – AE76**

**Product Name:**

Product Name	Alternative name			
	UK	France	Denmark	Germany
AE76	--	EB/7076	--	--

**Drawing:**

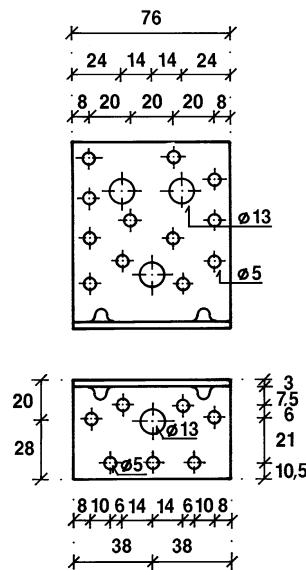

Figure D16-1 - AE76

**Material:**

Standard material : S250GD + Z275 according to EN 10346

Or stainless steel according to clause II-1

**Nail pattern:**

Beam to beam connection

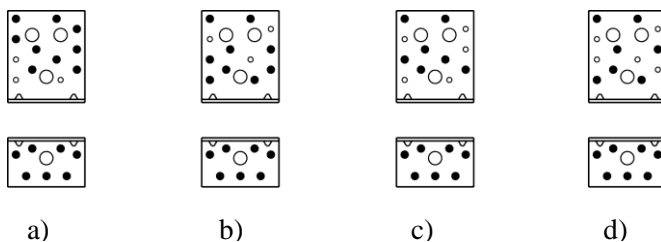

Figure D16-2

- a) Max. nailing with force  $F_1$ ,  $F_4$  and  $F_5$
- b) Max. nailing with force  $F_2$  and  $F_3$
- c) Min. nailing with Force  $F_1$ ,  $F_4$  and  $F_5$
- d) Min. nailing with Force  $F_2$  and  $F_3$

Beam to rigid connection



Figure D16-3

- a) Max. nailing with force  $F_1$ ,  $F_4$  and  $F_5$
- b) Max. nailing with force  $F_2$  and  $F_3$

For a force only in direction  $F_2$  it's allowed to use the washer of the used anchor bolt instead of the square washers US40/40/10G or US40/50/10G



**Modified characteristic capacities:**

Table D16-1 AE76 - beam to beam connection - connector nails

2 Angle Brackets per connection	Modified characteristic capacity per connection (kN)					
	R <sub>1,k</sub>		R <sub>2,k</sub> = R <sub>3,k</sub>		R <sub>4,k</sub> = R <sub>5,k</sub>	
Number of Nails	Connector nail according to ETA-04/0013					
	4,0x40	4,0x60	4,0x40	4,0x60	4,0x40	4,0x60
<b>Load duration: S</b>						
Minimum (fig. D16-2 c+d)	3,7	6,2	9,5	13,8	min:	min:
	5,3	8,8			8,6	9,4
Maximum (fig. D16-2 a+b)	3,8	6,2	10,6	15,6	$\frac{2,65b+105}{e-3,0}$	$\frac{4,41b+117}{e-3,0}$
	5,3	8,8				
<b>Load duration: M</b>						
Minimum (fig. D16-2 c+d)	3,3	5,5	8,4	12,2	min:	min:
	4,7	7,8			8,1	8,1
Maximum (fig. D16-2 a+b)	3,3	5,5	9,4	13,9	$\frac{2,35b+102}{e-3,0}$	$\frac{3,92b+113}{e-3,0}$
	4,7	7,8				

b and e are in mm

When the purlin has a wane on the side towards the Angle Bracket the value in the grey square is valid.

Factors for other load durations	R <sub>1,k</sub>		R <sub>2,k</sub> = R <sub>3,k</sub>		R <sub>4,k</sub> = R <sub>5,k</sub>	
	Connector nail according to ETA-04/0013					
	4,0x40	4,0x60	4,0x40	4,0x60	4,0x40	4,0x60
I multiply S by	1,22	1,22	1,22	1,22	1,11	1,11
L multiply M by	0,88	0,88	0,88	0,88	0,89	0,89
P multiply M by	0,75	0,75	0,75	0,75	0,79	0,77

Table D16-2 AE76 - beam to beam connection - connector nails

1 Angle Bracket per connection	Modified characteristic capacity per connection (kN)			
	$R_{1,k}$ Purlin may rotate		$R_{2,k} = R_{3,k}$	
Number of Nails	Connector nail according to ETA-04/0013			
	4,0x40	4,0x60	4,0x40	4,0x60
<b>Load duration: S</b>				
Minimum (fig. D16-2 c+d)	min: <u>63</u> f+40	min: <u>104</u> f+40	4,8	6,9
Maximum (fig. D16-2 a+b)	<u>35</u> f+8,5	<u>35</u> f+8,5	5,3	7,8
<b>Load duration: M</b>				
Minimum (fig. D16-2 c+d)	min: <u>56</u> f+40	min: <u>93</u> f+40	4,2	6,1
Maximum (fig. D16-2 a+b)	<u>35</u> f+8,5	<u>35</u> f+8,5	4,7	7,0

f is in mm

Factors for other load durations	$R_{1,k}$ Purlin may rotate		$R_{2,k} = R_{3,k}$	
	Connector nail according to ETA-04/0013			
	4,0x40	4,0x60	4,0x40	4,0x60
I multiply S by	1,00	1,00	1,22	1,22
L multiply M by	0,88	0,88	0,88	0,88
P multiply M by	0,75	0,75	0,75	0,75

Table D16-3 AE76 - beam to rigid support connection - connector nails

2 Angle Brackets per connection	Modified characteristic capacity per connection (kN)					
	$R_{1,k}$		$R_{2,k} = R_{3,k}$		$R_{4,k} = R_{5,k}$	
Number of Nails in vertical flap / 1 bolt in horizontal flap	Connector nail according to ETA-04/0013					
	4,0x40	4,0x60	4,0x40	4,0x60	4,0x40	4,0x60
<b>Load duration: S</b>						
Maximum (fig. D16-3)	7,2	11,7	6,8	10,6	$\frac{8,41b+145}{e-3,0}$	$\frac{8,41b+145}{e-3,0}$
	16,8	16,8			max: 8,6	max: 8,6
<b>Load duration: M</b>						
Maximum (fig. D16-3)	6,4	10,5	6,1	9,4	$\frac{8,41b+145}{e-3,0}$	$\frac{8,41b+145}{e-3,0}$
	16,8	16,8			max: 8,1	max: 8,1

b and e are in mm

Factors for other load durations	$R_{1,k}$		$R_{2,k} = R_{3,k}$		$R_{4,k} = R_{5,k}$	
	Connector nail according to ETA-04/0013					
	4,0x40	4,0x60	4,0x40	4,0x60	4,0x40	4,0x60
I multiply S by	1,00	1,00	1,22	1,22	1,00	1,00
L multiply M by	0,95	1,00	0,88	0,88	0,94	0,94
P multiply M by	0,81	1,00	0,75	0,75	0,82	0,87

AE76	connection with 2 angle brackets			
factor:	for $F_1$	for $F_{2/3}$	for $F_{4/5}$ , bolt 1	for $F_{4/5}$ , bolt 2
$k_{ax}$	0,54	-	$1,08 \times e/(b+7)$	-
$k_{lat}$	-	0,50	-	1,00

For each bolt it's needed to check:  $R_{bolt,d,lateral} \geq k_{lat} \times F_{i,d}$  ;  $R_{bolt,d,axial} \geq k_{ax} \times F_{i,d}$  ; and also the combination

Table D16-4 AE76 - beam to rigid support connection - connector nails

1 Angle Bracket per connection	Modified characteristic capacity per connection (kN)			
	$R_{1,k}$ Purlin may rotate		$R_{2,k} = R_{3,k}$	
Number of Nails in vertical flap / 1 bolt in horizontal flap	Connector nail according to ETA-04/0013			
	4,0x40	4,0x60	4,0x40	4,0x60
<b>Load duration: S</b>				
Maximum (fig. D16-3)	$\frac{34}{f+5}$	$\frac{34}{f+5}$	3,4	5,3
<b>Load duration: M</b>				
Maximum (fig. D16-3)	$\frac{34}{f+5}$	$\frac{34}{f+5}$	3,0	4,7

f is in mm

Factors for other load durations	$R_{1,k}$		$R_{2,k} = R_{3,k}$	
	Connector nail according to ETA-04/0013			
	4,0x40	4,0x60	4,0x40	4,0x60
I multiply S by	1,00	1,00	1,22	1,22
L multiply M by	1,00	1,00	0,88	0,88
P multiply M by	1,00	1,00	0,75	0,75

AE76	connection with 1 angle brackets			
factor:	for $F_1$	for $F_{2/3}$	for $F_4$	for $F_5$
$k_{ax}$	$(f+45)/28$	0,74	-	-
$k_{lat}$	-	1,00	-	-

For each bolt it's needed to check:  $R_{bolt,d,lateral} \geq k_{lat} \times F_{i,d}$  ;  $R_{bolt,d,axial} \geq k_{ax} \times F_{i,d}$  ; and also the combination

**Annex D17 – AE116**

**Product Name:**

Product Name	Alternative name			
	UK	France	Denmark	Germany
AE116	--	--	--	--

**Drawing:**

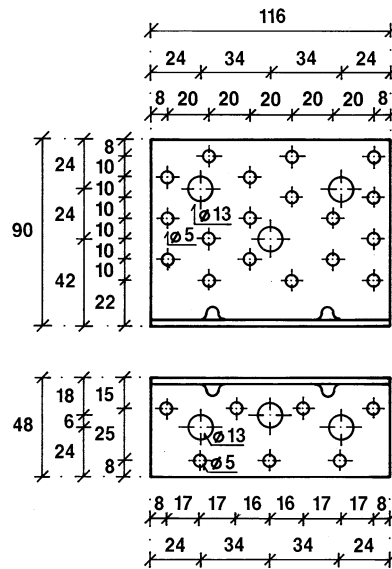

Figure D17-1 - AE116

**Material:**

Standard material : S250GD + Z275 according to EN 10346

Or stainless steel according to clause II-1

**Nail pattern:**

Beam to beam connection

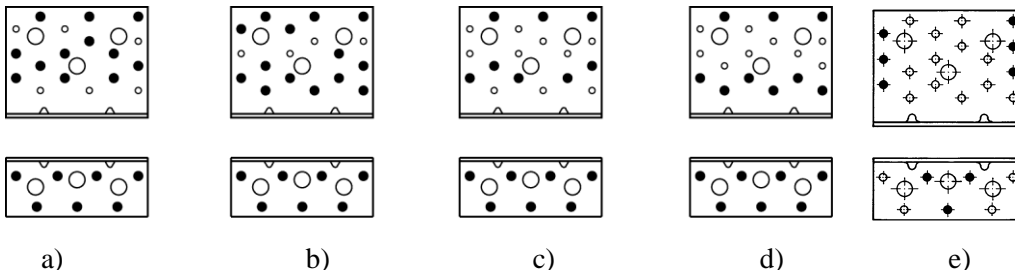

Figure D17-2

- a) Max. nailing with force  $F_1$ ,  $F_4$  and  $F_5$
- b) Max. nailing with force  $F_2$  and  $F_3$
- c) Min. nailing with force  $F_1$ ,  $F_4$  and  $F_5$
- d) Min. nailing with force  $F_2$  and  $F_3$
- e) Nailing with force  $F_6$

Beam to rigid connection

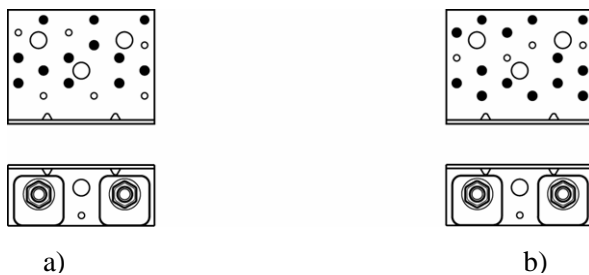

Figure D17-3

- a) Max. nailing with force  $F_1$ ,  $F_4$  and  $F_5$
- b) Max. nailing with force  $F_2$  and  $F_3$

For a force only in direction  $F_2$  it's allowed to use the washer of the used anchor bolt instead of the square washers US40/40/10G or US40/50/10G



1 Angle Bracket per connection	Modified characteristic capacity per connection (kN)			
	$R_{1,k}$ Purlin may rotate		$R_{2,k} = R_{3,k}$	
Number of Nails	Connector nail according to ETA-04/0013			
	4,0x40	4,0x60	4,0x40	4,0x60
<b>Load duration: S</b>				
Minimum (fig. D17-2 c+d)	min: $\frac{71}{f+40}$	$\frac{42}{f+13}$	7,5	10,2
Maximum (fig. D17-2 a+b)	$\frac{42}{f+13}$		8,6	12,0
<b>Load duration: M</b>				
Minimum (fig. D17-2 c+d)	min: $\frac{64}{f+40}$	min: $\frac{106}{f+40}$	6,6	9,1
Maximum (fig. D17-2 a+b)	$\frac{42}{f+13}$	$\frac{42}{f+13}$	7,6	10,6
f is in mm				
Factors for other load durations	$R_{1,k}$ Purlin may rotate		$R_{2,k} = R_{3,k}$	
	Connector nail according to ETA-04/0013			
	4,0x40	4,0x60	4,0x40	4,0x60
I multiply S by	1,00	1,00	1,22	1,22
L multiply M by	0,88	0,88	0,88	0,88
P multiply M by	0,75	0,75	0,75	0,75

Table D17-3 AE116 - beam to rigid support connection - connector nails

2 Angle Brackets per connection	Modified characteristic capacity per connection (kN)					
	$R_{1,k}$		$R_{2,k} = R_{3,k}$		$R_{4,k} = R_{5,k}$	
Number of Nails in vertical flap / 2 bolts in horizontal flap	Connector nail according to ETA-04/0013					
	4,0x40	4,0x60	4,0x40	4,0x60	4,0x40	4,0x60
<b>Load duration: S</b>						
Maximum (fig. D17-3)	8,4	13,8	23,0	25,6	min:	min:
	22,6	28,1			12,8	12,8
					$\frac{11,3b+206}{e-3,0}$	$\frac{14,0b+225}{e-3,0}$
<b>Load duration: M</b>						
Maximum (fig. D17-3)	7,5	12,3	20,4	22,8	min:	min:
	20,2	28,1			12,1	12,1
					$\frac{10,1b+197}{e-3,0}$	$\frac{14,0b+225}{e-3,0}$

b and e are in mm

When the purlin has a wane on the side towards the Angle Bracket the value in the grey square is valid.

Factors for other load durations	$R_{1,k}$		$R_{2,k} = R_{3,k}$		$R_{4,k} = R_{5,k}$	
	Connector nail according to ETA-04/0013					
	4,0x40	4,0x60	4,0x40	4,0x60	4,0x40	4,0x60
I multiply S by	1,22	1,22	1,22	1,22	1,11	1,00
	1,22	1,00				
L multiply M by	0,88	0,88	0,88	0,88	0,89	0,94
	0,88	0,95				
P multiply M by	0,75	0,75	0,75	0,75	0,77	0,83
	0,75	0,82				

AE116	connection with 2 angle brackets			
factor:	for $F_1$	for $F_{2/3}$	for $F_{4/5}$ , bolt 1	for $F_{4/5}$ , bolt 2
$k_{ax}$	0,65	-	$1,3 \times e/(b+7)$	-
$k_{lat}$	-	0,5 and $M=F_2 \times 12mm \times 1$	-	1,00

For each bolt it's needed to check:  $R_{bolt,d,lateral} \geq k_{lat} \times F_{i,d}$  ;  $R_{bolt,d,axial} \geq k_{ax} \times F_{i,d}$  ; and also the combination



1 Angle Bracket per connection	Modified characteristic capacity per connection (kN)			
	R <sub>1,k</sub> Purlin may rotate		R <sub>2,k</sub> = R <sub>3,k</sub>	
Number of Nails in vertical flap / 2 bolts in horizontal flap	Connector nail according to ETA-04/0013			
	4,0x40	4,0x60	4,0x40	4,0x60
<b>Load duration: S</b>				
Maximum (fig. D17-3)	$\frac{42}{f+9}$	$\frac{42}{f+9}$	11,5	12,8
<b>Load duration: M</b>				
Maximum (fig. D17-3)	$\frac{42}{f+9}$	$\frac{42}{f+9}$	10,2	11,4

b and e are in mm

Factors for other load durations	R <sub>1,k</sub> Purlin may rotate		R <sub>2,k</sub> = R <sub>3,k</sub>	
	Connector nail according to ETA-04/0013			
	4,0x40	4,0x60	4,0x40	4,0x60
I multiply S by	1,00	1,00	1,22	1,22
L multiply M by	1,00	1,00	0,88	0,88
P multiply M by	1,00	1,00	0,75	0,75

AE116	connection with 1 angle brackets			
factor:	for F <sub>1</sub>	for F <sub>2/3</sub>	for F <sub>4</sub>	for F <sub>5</sub>
k <sub>ax</sub>	(f+44)/23	0,18	-	-
k <sub>lat</sub>	-	1,00	-	-

For each bolt it's needed to check:  $R_{bolt,d,lateral} \geq k_{lat} \times F_{i,d}$  ;  $R_{bolt,d,axial} \geq k_{ax} \times F_{i,d}$  ; and also the combination

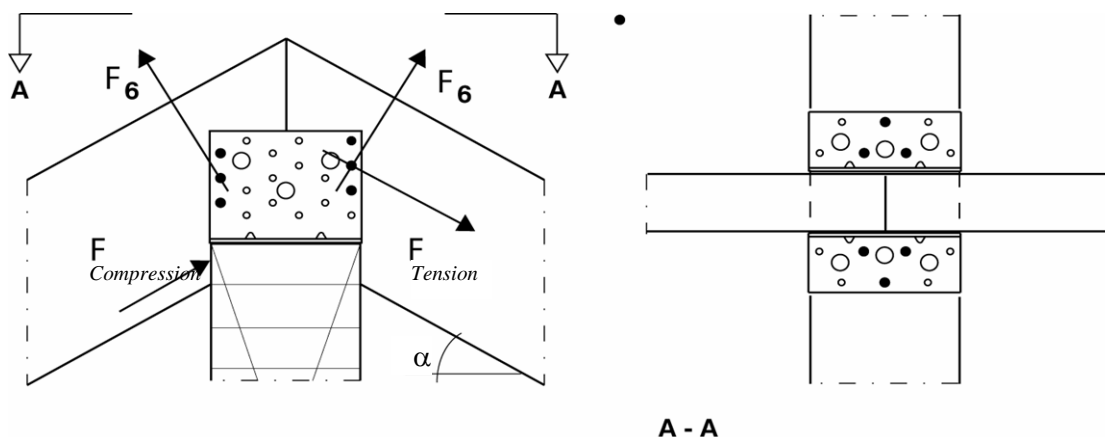

2 Angle Brackets per connection	Modified characteristic capacity per connection									
	R <sub>6,singlesided</sub> on one rafter				Symmetrical R <sub>6,symmetrical</sub> on each of two rafters		Height h <sub>contact</sub> of contact area between rafter and ridge beam			
Load duration: I	b <sub>ridgebeam</sub> [mm]									
	80	90	100	120	>80	80	90	100	120	
Roof pitch α [°]	R <sub>6,singlesided</sub> [kN]				R <sub>6,symmetrical</sub> [kN]	h <sub>contact</sub> [mm]				
0	4,5	4,6	4,6	4,6	2,7	0	0	0	0	
5	4,6	4,6	4,6	4,7	2,7	3	4	4	5	
10	4,6	4,6	4,7	4,7	2,7	7	8	9	11	
15	4,7	4,7	4,7	4,7	2,8	11	12	13	16	
20	4,7	4,7	4,7	4,7	2,9	15	16	18	22	
25	4,7	4,8	4,8	4,8	3,0	19	21	23	28	
30	4,8	4,8	4,8	4,8	3,1	23	26	29	35	
35	4,8	4,8	4,8	4,8	3,3	28	32	35	42	
40	4,9	4,9	4,9	4,9	3,5	34	38	42	50	
45	4,9	4,9	4,9	4,9	3,8	40	45	50	60	

Same roof pitch at both side of the roof

Connector nail according to ETA-04/0013 4,0x40 in rafter and 4,0x60 in ridge beam

The capacities in the table are for Instant load duration, the capacities for other load durations are found by multiplication by the factor c

Factor c for other load durations	P	L	M	S
	0,55	0,64	0,73	0,82

*Combined symmetrical and single sided forces*

For a combination of symmetrical and single sided load, the load carrying capacity is found from the following criteria:

$$\frac{F_{6,symmetrical}}{R_{6,symmetrical,d}} + \frac{F_{6,singlesided}}{R_{6,singlesided,d}} \leq 1$$

*Combined symmetrical and single sided and tension force*

For a combination of symmetrical, single sided force and tension in a rafter, the load carrying capacity is found from the following criteria:

$$\frac{F_{6,symmetrical}}{R_{6,symmetrical,d}} + \frac{F_{6,singlesided}}{R_{6,singlesided,d}} + \frac{F_{tension} \cdot \cos(\alpha)}{R_{tension,d}} \leq 1$$

Where:  $R_{tension} = 13 \cdot c$  kN, where  $c$  is the load duration factor.

*Compression*

The compressive force in the rafter is decomposed into a vertical force,  $F_{compression} \cdot \sin(\alpha)$  and a horizontal force

$$F_{compression} \cdot \cos(\alpha).$$

The compressive force on the side of the ridge beam consist of contributions from both the rafter loaded in tension,  $F_{tension} \cdot \cos(\alpha)$  and from the rafter loaded in compression  $F_{compression} \cdot \cos(\alpha)$ . The ridge beam must be checked for the compressive force acting perpendicular to the grain.

The maximum force considering the capacity perpendicular to the grain is found from the following expression:

$$R_{c,90,k} = f_{c,90,k} \cdot \left( 2,38 - \frac{b_{rafter}}{250} \right) \cdot \left( 1 + \frac{b_{ridgebeam}}{6 \cdot b_{rafter}} \right) \cdot b_{rafter} \cdot h_{contact}$$

Where:

$f_{c,90,k}$  = characteristic compression strength perpendicular to the grain of ridge beam

$b_{rafter}$  = width of rafter [mm]

$b_{ridgebeam}$  = width of ridge beam [mm]

$h_{contact}$  = height of contact area between rafter and ridge beam, see table above

The capacity of the connection is verified from the following criteria:

$$(F_{compression} + F_{tension}) \cdot \cos(\alpha) \leq R_{c,90,k}$$

**Product Name:**

Product Name	Alternative name			
	UK	France	Denmark	Germany
AG40312	--	EB/7312	--	--
AG40412	--	--	--	--
AG40314	--	--	--	--
AG40414	--	--	--	--

**Drawing:**

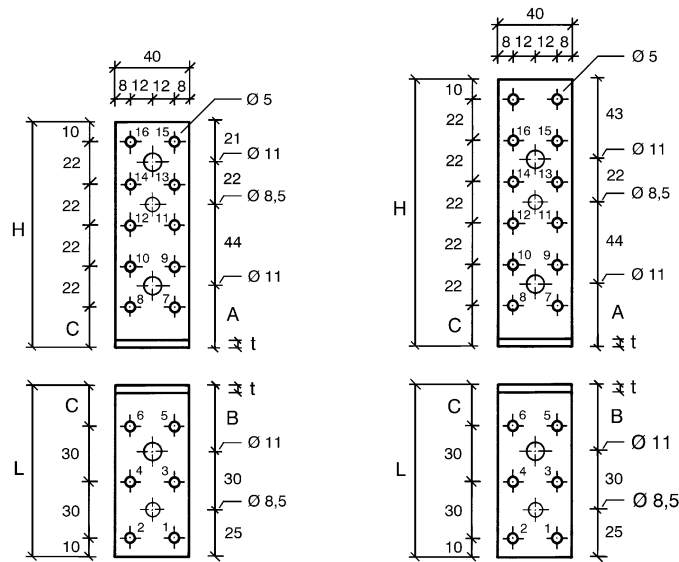

Figure D18-1 - AG40312/AG40412 (3 and 4 mm) and AG40314/AG40414 (3 and 4 mm)

**Material:**

Standard material : S250GD + Z275 according to EN 10346 – 3 mm  
 Or stainless steel according to clause II-1

**Nail pattern:**

Beam to beam and beam to column connection

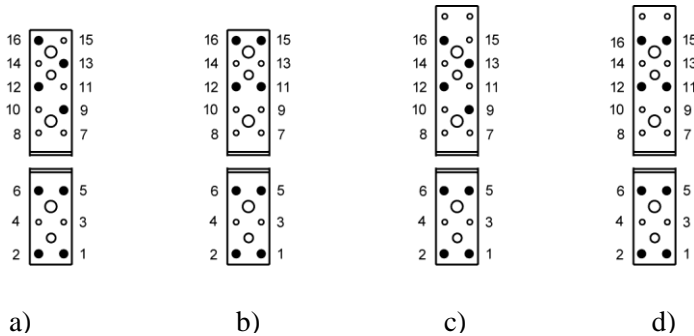

Figure D18-2

- a) Beam to beam nailing for AG40312 and AG40412
- b) Beam to column nailing for AG40312 and AG40412
- c) Beam to beam nailing for AG40314 and AG40414
- d) Beam to column nailing for AG40314 and AG40414

Beam to rigid connection

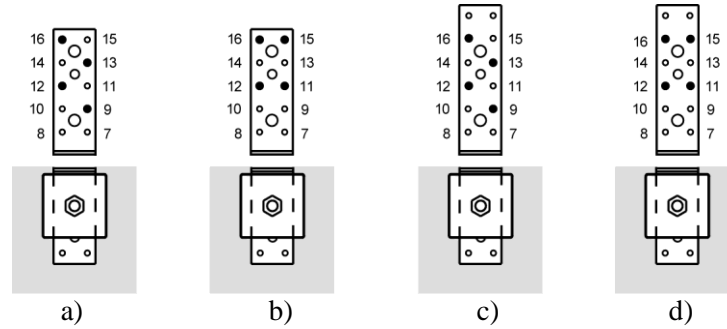

Figure D18-3

- a) Beam to rigid support nailing for AG40412
- b) Column to rigid support nailing for AG40412
- c) Beam to rigid support nailing for AG40414
- d) Column to rigid support nailing for AG40414

**Modified characteristic capacities:**

Table D18-1 AG40312 and AG40314 – beam/column to beam connection - connector nails

2 Angle Brackets per connection	Modified Characteristic capacity per connection (kN)					
	R <sub>1,k</sub>		R <sub>2,k</sub> = R <sub>3,k</sub>		R <sub>4,k</sub> = R <sub>5,k</sub>	
Load duration	Connector nail according to ETA-04/0013					
	4,0x40	4,0x60	4,0x40	4,0x60	4,0x40	4,0x60
Beam/Purlin: 4+4 (fig.D18-2 a+c)						
Beam/Column: 4+4 (fig. D18-2 b+d)						
S	2,7	3,9	2,8	4,0	e≤0,29b+15 4,6 e>0,29b+15 <u>1,32b+56</u> e-3,0	e≤0,48b+19 4,6 e>0,48b+19 <u>1,96b+70</u> e-3,0
M	2,4	3,6	2,6	3,6	e≤0,27b+15 4,3 e>0,27b+15 <u>1,18b+52</u> e-3,0	e≤0,42b+18 4,3 e>0,42b+18 <u>1,8b+66</u> e-3,0

b and e are in mm

Factors for other load durations	R <sub>1,k</sub>		R <sub>2,k</sub> = R <sub>3,k</sub>		R <sub>4,k</sub> = R <sub>5,k</sub>	
	Connector nail according to ETA-04/0013					
	4,0x40	4,0x60	4,0x40	4,0x60	4,0x40	4,0x60
I multiply S by	1,19	1,16	1,22	1,22	1,11	1,11
L multiply M by	0,88	0,91	0,88	0,88	0,88	0,92
P multiply M by	0,75	0,81	0,75	0,75	0,78	0,83

1 Angle Bracket per connection	Modified Characteristic capacity per connection (kN)			
	$R_{1,k}$ Purlin may rotate		$R_{2,k} = R_{3,k}$	
Load duration	Connector nail according to ETA-04/0013			
	4,0x40	4,0x60	4,0x40	4,0x60
Beam/Purlin: 4+4 (fig.D18-2 a+c)				
Beam/Column: 4+4 (fig. D18-2 b+d)				
P	$\frac{55}{f+81}$ $\frac{20}{f+19}$	$\frac{20}{f+19}$	0,9	1,3
L	$\frac{20}{f+19}$	$\frac{20}{f+19}$	1,1	1,6
M	$\frac{20}{f+19}$	$\frac{20}{f+19}$	1,3	1,8
S	$\frac{20}{f+19}$	$\frac{20}{f+19}$	1,4	2,0
I	$\frac{20}{f+19}$	$\frac{20}{f+19}$	1,7	2,5

f is in mm

Table D18-3 AG40412 and AG40414 – beam/column to beam connection - connector nails

2 Angle Brackets per connection	Modified characteristic capacity per connection (kN)					
	R <sub>1,k</sub>		R <sub>2,k</sub> = R <sub>3,k</sub>		R <sub>4,k</sub> = R <sub>5,k</sub>	
Load duration	Connector nail according to ETA-04/0013					
	4,0x40	4,0x60	4,0x40	4,0x60	4,0x40	4,0x60
Beam/beam: 4+4 (fig. D18-2 a+c)						
Beam/Column: 4+4 (fig. D18-2 b+d)						
S	2,7	4,4	2,9	4,0	e ≤ 0,22b+16 6,1 e > 0,22b+16 <u>1,32b+76</u> e-4,0	e ≤ 0,36b+19 6,1 e > 0,36b+19 <u>2,21b+96</u> e-4,0
M	2,4	3,9	2,6	3,5	e ≤ 0,20b+16 5,75 e > 0,20b+16 <u>1,18b+73</u> e-4,0	e ≤ 0,34b+19 5,75 e > 0,34b+19 <u>1,96b+90</u> e-4,0

f are in mm

Factors for other load durations	R <sub>1,k</sub>		R <sub>2,k</sub> = R <sub>3,k</sub>		R <sub>4,k</sub> = R <sub>5,k</sub>	
	Connector nail according to ETA-04/0013					
	4,0x40	4,0x60	4,0x40	4,0x60	4,0x40	4,0x60
I multiply S by	1,22	1,22	1,22	1,22	1,10	1,10
L multiply M by	0,88	0,88	0,88	0,88	0,85	0,89
P multiply M by	0,75	0,75	0,75	0,75	0,65	0,78

Table D18-4 AG40412 and AG40414 – beam/column to beam connection - connector nails

1 Angle Bracket per connection	Modified characteristic capacity per connection (kN)			
	$R_{1,k}$ Purlin may rotate		$R_{2,k} = R_{3,k}$	
Load duration	Connector nail according to ETA-04/0013			
	4,0x40	4,0x60	4,0x40	4,0x60
Beam/beam: 4+4 (fig. D18-2 a+c)				
Beam/Column: 4+4 (fig. D18-2 b+d)				
P	min: <u>55</u> f + 82 <u>35</u> f + 20	min: <u>91</u> f + 82 <u>35,0</u> f + 20	1,0	1,3
L	min: <u>64</u> f + 82 <u>35</u> f + 20	min: <u>106</u> f + 82 <u>35,0</u> f + 20	1,1	1,6
M	min: <u>73</u> f + 82 <u>35</u> f + 20	min: <u>122</u> f + 82 <u>35</u> f + 20	1,3	1,8
S	min: <u>82</u> f + 82 <u>35</u> f + 20	<u>35</u> f + 20	1,5	2,0
I	min: <u>100,0</u> f + 82 <u>35,0</u> f + 20	<u>35</u> f + 20	1,8	2,4

f is in mm.



Table D18-5 AG40412 and AG40414 – beam/column to rigid support connection - connector nails/bolt

2 Angle Brackets per connection	Characteristic capacity per connection (kN)					
	$R_{1,k}$		$R_{2,k} = R_{3,k}$		$R_{4,k} = R_{5,k}$	
Load duration	Connector nail according to ETA-04/0013					
	4,0x40	4,0x60	4,0x40	4,0x60	4,0x40	4,0x60
Beam/Purlin: Nails in hole no.: 11,12,15,16 / 1 bolt						
Beam/Column: Nails in hole no.: 9,12,13,16 / 1 bolt						
S	8,1	8,1	1,0	1,0	$\frac{4,1b+61}{e-4,0}$ max: 6,1	$\frac{4,1b+61}{e-4,0}$ max: 6,1
M	7,6	8,1	0,8	1,0	$\frac{3,8b+60}{e-4,0}$ max: 5,7	$\frac{4,1b+61}{e-4,0}$ max: 5,7

b and e are in mm

Factors for other load durations	$R_{1,k}$		$R_{2,k} = R_{3,k}$		$R_{4,k} = R_{5,k}$	
	Connector nail according to ETA-04/0013					
	4,0x40	4,0x60	4,0x40	4,0x60	4,0x40	4,0x60
I multiply S by	1,00	1,00	1,00	1,00	1,00	1,00
L multiply M by	0,91	1,00	1,00	1,00	0,86	0,95
P multiply M by	0,78	1,00	0,75	1,00	0,67	0,88

*Connection with bolt*

AG	connection with 2 angle brackets			
factor:	for $F_1$	for $F_{2/3}$	for $F_{4/5}$ , bolt 1	for $F_{4/5}$ , bolt 2
$k_{ax}$	0,93	1,69	$1,85 \times e/b$	-
$k_{lat}$	-	0,50	-	1,00

For each bolt it's needed to check:  $R_{bolt,d,lateral} \geq k_{lat} \times F_{i,d}$  ;  $R_{bolt,d,axial} \geq k_{ax} \times F_{i,d}$ ; and also the combination

Table D18-6 AG40412 and AG40414 – beam/column to rigid support - connector nails/bolt

1 Angle Bracket per connection	Modified characteristic capacity per connection (kN)			
	$R_{1,k}$ Purlin may rotate		$R_{2,k} = R_{3,k}$	
Load duration	Connector nail according to ETA-04/0013			
	4,0x40	4,0x60	4,0x40	4,0x60
Beam/rigid support: 4+1 (fig. D18-3 a+c)				
Column/rigid support: 4+1 (fig. D18-3 b+d)				
S	min: <u>47</u> f+7 <u>148</u> f+67	min: <u>47</u> f+7 <u>148</u> f+67	0,5	0,5
M	min: <u>47</u> f+7 <u>148</u> f+67	min: <u>47</u> f+7 <u>148</u> f+67	0,4	0,5

f is in mm

Factors for other load durations	$R_{1,k}$ Purlin may rotate		$R_{2,k} = R_{3,k}$	
	Connector nail according to ETA-04/0013			
	4,0x40	4,0x60	4,0x40	4,0x60
I multiply S by	1,00	1,00	1,00	1,00
L multiply M by	1,00	1,00	1,00	1,00
P multiply M by	1,00	1,00	0,75	1,00

*Connection with bolt*

AG	connection with 1 angle brackets			
factor:	for $F_1$	for $F_{2/3}$	for $F_4$	for $F_5$
$k_{ax}$	1,85	3,38	-	-
$k_{lat}$	-	1,00	-	-

For each bolt it's needed to check:  $R_{bolt,d,lateral} \geq k_{lat} \times F_{i,d}$  ;  $R_{bolt,d,axial} \geq k_{ax} \times F_{i,d}$  ; and also the combination

**Annex D19 – AH9035**

**Product Name:**

Product Name	Alternative name			
	UK	France	Denmark	Germany
AH9035	--	--	--	--

**Drawing:**

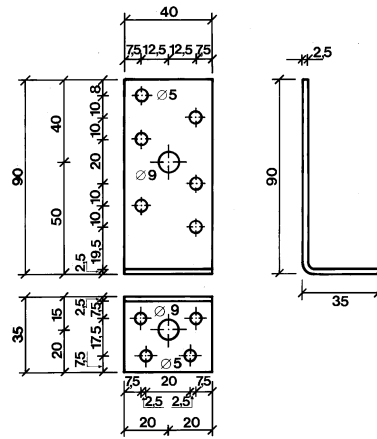

Figure D19-1 – AH9035

**Material:**

Standard material : S250GD + Z275 according to EN 10346  
 Or stainless steel according to clause II-1

**Nail pattern:**

Beam to concrete connection

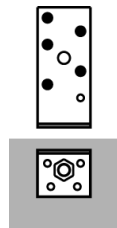

Figure D19-2  
 Beam to concrete connection

**Modified characteristic capacities:**

Table D19-1 AH9035 - beam to concrete connection - connector nails/bolt

1 Angle Bracket per connection	Modified characteristic capacity per connection (kN)	
	5 nails in vertical flap 1 M8 bolt in horizontal flap	Connector nail according to ETA-04/0013
	4,0x40	4,0x60
R <sub>1,k</sub> = min:	(1,43+(n-2)·1,64)·c 1,9	(2,25+(n-2)·2,13)·c 1,9
	(3,09+(n-2)·1,64)·c 4,0	(4,10+(n-2)·2,13)·c 4,0
	0,32·F <sub>b,k</sub> +0,91 0,19·F <sub>anchor,concrete</sub> +0,54	

When the purlin has a wane on the side towards the Angle Bracket the value in the grey square is valid.

The capacities in the table are for short load duration, the capacities for other load durations are found by multiplication by the factor c

Factor c for other load durations	P	L	M	S	I
	0,67	0,78	0,89	1,00	1,22

*Connection with bolt*

The bolt shall have a capacity to sustain an axial force of  $F_{1,d} \times 3,1$

**Annex D20 – AJ60416**

**Product Name:**

Product Name	Alternative name			
	UK	France	Denmark	Germany
AJ60416	--	--	--	--

**Drawing:**

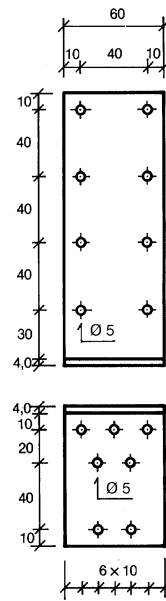

Figure D20-1 – AJ60416

**Material:**

Standard material : S250GD + Z275 according to EN 10346  
 Or stainless steel according to clause II-1

**Nail pattern:**

Beam to beam connection

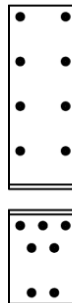

Figure D20-2  
 Beam to beam connection

**Modified characteristic capacities:**

Table D20-1 AJ60416 - beam to beam connection - connector nails

2 Angle Brackets per connection	Modified characteristic capacity per connection (kN)		
	$R_{1,k}$	$R_{2,k} = R_{3,k}$	$R_{4,k} = R_{5,k}$
Load duration	Connector nail according to ETA-04/0013: Full nailing. Vertical flap: 8 CNA4,0x40 - Horizontal flap: 7 CNA4,0x60		
S	10,2	7,0	min: 8,9  $\frac{5,11b+107}{e-4,0}$
M	9,3	6,2	min: 7,1  $\frac{4,65b+103}{e-4,0}$

b and e are in mm

Factors for other load durations	$R_{1,k}$	$R_{2,k} = R_{3,k}$	$R_{4,k} = R_{5,k}$
		Connector nail according to ETA-04/0013: Full nailing. Vertical flap: 8 CNA4,0x40 - Horizontal flap: 7 CNA4,0x60	
I multiply S by	1,18	1,22	1,14
L multiply M by	0,90	0,88	0,85
P multiply M by	0,80	0,75	0,79

Table D20-2 AJ60416 - beam to beam connection - connector nails

1 Angle Bracket per connection	Modified characteristic capacity per connection (kN)			
	$R_{1,k}$	$R_{2,k} = R_{3,k}$	$R_{4,k}$	$R_{5,k}$
Load duration	Purlin may rotate Connector nail according to ETA-04/0013: Full nailing. Vertical flap: 8 CNA4,0x40 - Horizontal flap: 7 CNA4,0x60			
S	min: <u>205</u> f+74 <u>55</u> f <u>53,1</u> f+12	3,5	min: 6,0  <u>53,1</u> e-2,0	min: 2,8  <u>109</u> 114-e <u>4,6(b+2,0)</u> e
M	min: <u>182,0</u> f+74 <u>50,0</u> f <u>53,1</u> f+12	3,1	min: 5,6  <u>53,1</u> e-2,0	min: 2,6  <u>96</u> 114-e <u>4,2(b+2,0)</u> e

f, e and b are in mm

Factors for other load durations	$R_{1,k}$	$R_{2,k} = R_{3,k}$	$R_{4,k}$	$R_{5,k}$
		Purlin may rotate Connector nail according to ETA-04/0013: Full nailing. Vertical flap: 8 CNA4,0x40 - Horizontal flap: 7 CNA4,0x60		
I multiply S by	1,00	1,22	1,00	1,14
L multiply M by	0,88	0,88	0,95	0,88
P multiply M by	0,75	0,75	0,88	0,75

**Annex D21 – AJ80416**

**Product Name:**

Product Name	Alternative name			
	UK	France	Denmark	Germany
AJ80416	--	--	--	--

**Drawing:**

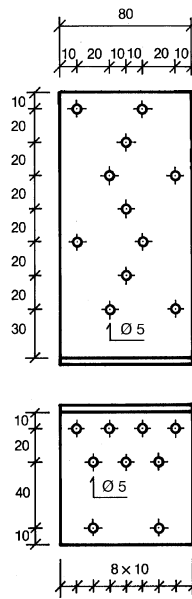

Figure D21-1 – AJ80416

**Material:**

Standard material : S250GD + Z275 according to EN 10346  
 Or stainless steel according to clause II-1

**Nail pattern:**

Beam to beam connection



Figure D21-2  
 Beam to beam connection

**Modified characteristic capacities:**

Table D21-1 AJ80416 - beam to beam connection - connector nails

2 Angle Brackets per connection	Modified characteristic capacity per connection (kN)		
	$R_{1,k}$	$R_{2,k} = R_{3,k}$	$R_{4,k} = R_{5,k}$
Load duration	Connector nail according to ETA-04/0013: Full nailing. Vertical flap: 11 CNA4,0x40 - Horizontal flap: 9 CNA4,0x60		
S	14,0	9,0	min: 12,4  $\frac{7,02b+144}{e-4,0}$
M	12,8	8,0	min: 11,7  $\frac{6,39b+139}{e-4,0}$

b and e are in mm

Factors for other load durations	$R_{1,k}$	$R_{2,k} = R_{3,k}$	$R_{4,k} = R_{5,k}$
		Connector nail according to ETA-04/0013: Full nailing. Vertical flap: 11 CNA4,0x40 - Horizontal flap: 9 CNA4,0x60	
I multiply S by	1,18	1,22	1,11
L multiply M by	0,90	0,88	0,86
P multiply M by	0,80	0,75	0,65

Table D21-2 AJ80416 - beam to beam connection - connector nails

1 Angle Bracket per connection	Modified characteristic capacity per connection (kN)			
	$R_{1,k}$	$R_{2,k} = R_{3,k}$	$R_{4,k}$	$R_{5,k}$
Load duration	Purlin may rotate			
	Connector nail according to ETA-04/0013: Full nailing. Vertical flap: 11 CNA4,0x40 - Horizontal flap: 9 CNA4,0x60			
S	min: $\frac{274}{f+74}$ 83 f $\frac{70,8}{f+12}$	4,5	min: 8,0  $\frac{70,8}{e-2,0}$	min: 3,7  $\frac{163}{121-e}$ $\frac{6,3(b+2,0)}{e}$
M	min: $\frac{243}{f+74}$ 74 f $\frac{70,8}{f+12}$	4,0	min: 7,5  $\frac{70,8}{e-2,0}$	min: 3,5  $\frac{145}{121-e}$ $\frac{5,7(b+2,0)}{e}$

f, e and b are in mm

Factors for other load durations	$R_{1,k}$	$R_{2,k} = R_{3,k}$	$R_{4,k}$	$R_{5,k}$
		Purlin may rotate Connector nail according to ETA-04/0013: Full nailing. Vertical flap: 11 CNA4,0x40 - Horizontal flap: 9 CNA4,0x60		
I multiply S by	1,00	1,22	1,00	1,14
L multiply M by	0,88	0,88	0,93	0,88
P multiply M by	0,75	0,75	0,87	0,75



**Annex D22 – AJ99416**

**Product Name:**

Product Name	Alternative name			
	UK	France	Denmark	Germany
AJ99416	--	--	--	--

**Drawing:**

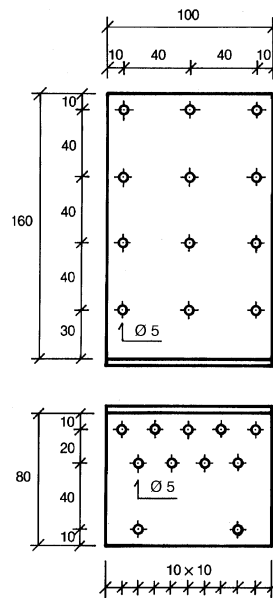

Figure D22-1 – AJ99416

**Material:**

Standard material: S250GD + Z275 according to EN 10346  
 Or stainless steel according to clause II-1

**Nail pattern:**

Beam to beam connection

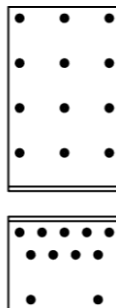

Figure D22-2  
 Beam to beam connection

**Modified characteristic capacities:**

Table D22-1 AJ99416 - beam to beam connection - connector nails

2 Angle Brackets per connection	Modified characteristic capacity per connection (kN)		
	R <sub>1,k</sub>	R <sub>2,k</sub> = R <sub>3,k</sub>	R <sub>4,k</sub> = R <sub>5,k</sub>
Load duration	Connector nail according to ETA-04/0013: Full nailing. Vertical flap: 12 CNA4,0x40 - Horizontal flap: 11 CNA4,0x60		
S	17,9	11,7	min: 13,1  $\frac{8,93b+181}{e-4,0}$
M	15,9	10,4	min: 10,9  $\frac{7,93b+174}{e-4,0}$

b and e are in mm

Factors for other load durations	R <sub>1,k</sub>	R <sub>2,k</sub> = R <sub>3,k</sub>	R <sub>4,k</sub> = R <sub>5,k</sub>
		Connector nail according to ETA-04/0013: Full nailing. Vertical flap: 12 CNA4,0x40 - Horizontal flap: 11 CNA4,0x60	
I multiply S by	1,18	1,22	1,14
L multiply M by	0,88	0,88	0,88
P multiply M by	0,75	0,75	0,77

Table D22-2 AJ99416 - beam to beam connection - connector nails

1 Angle Bracket per connection	Modified characteristic capacity per connection (kN)			
	R <sub>1,k</sub>	R <sub>2,k</sub> = R <sub>3,k</sub>	R <sub>4,k</sub>	R <sub>5,k</sub>
Load duration	Connector nail according to ETA-04/0013: Full nailing. Vertical flap: 12 CNA4,0x40 - Horizontal flap: 11 CNA4,0x60			
S	min: $\frac{342}{f+74}$ $\frac{89}{f+12}$ $\frac{83}{f}$	5,9	min: 10,0  $\frac{89}{e-2,0}$	min: 4,7  $\frac{163}{114-e}$  $\frac{8,0(b+2,0)}{e}$
M	min: $\frac{304}{f+74}$ $\frac{89}{f+12}$ $\frac{74}{f}$	5,2	min: 9,4  $\frac{89}{e-2,0}$	min: 4,3  $\frac{145}{114-e}$  $\frac{7,1(b+2,0)}{e}$

f, e and b are in mm

Factors for other load durations	R <sub>1,k</sub>	R <sub>2,k</sub> = R <sub>3,k</sub>	R <sub>4,k</sub>	R <sub>5,k</sub>
		Connector nail according to ETA-04/0013: Full nailing. Vertical flap: 12 CNA4,0x40 - Horizontal flap: 11 CNA4,0x60		
I multiply S by	1,00	1,22	1,00	1,13
L multiply M by	0,88	0,88	0,94	0,88
P multiply M by	0,75	0,75	0,87	0,75

## Annex D23 – Knight brackets

### Product Name;

Product Name	Alternative name			
	UK	France	Denmark	Germany
KNAG90	--	ECH90/19090	--	--
KNAG130	--	ECH125/19130	--	--
KNAG170	--	ECH160/19170	--	--
KNAG210	--	ECH200/19210	--	--

### Drawing:

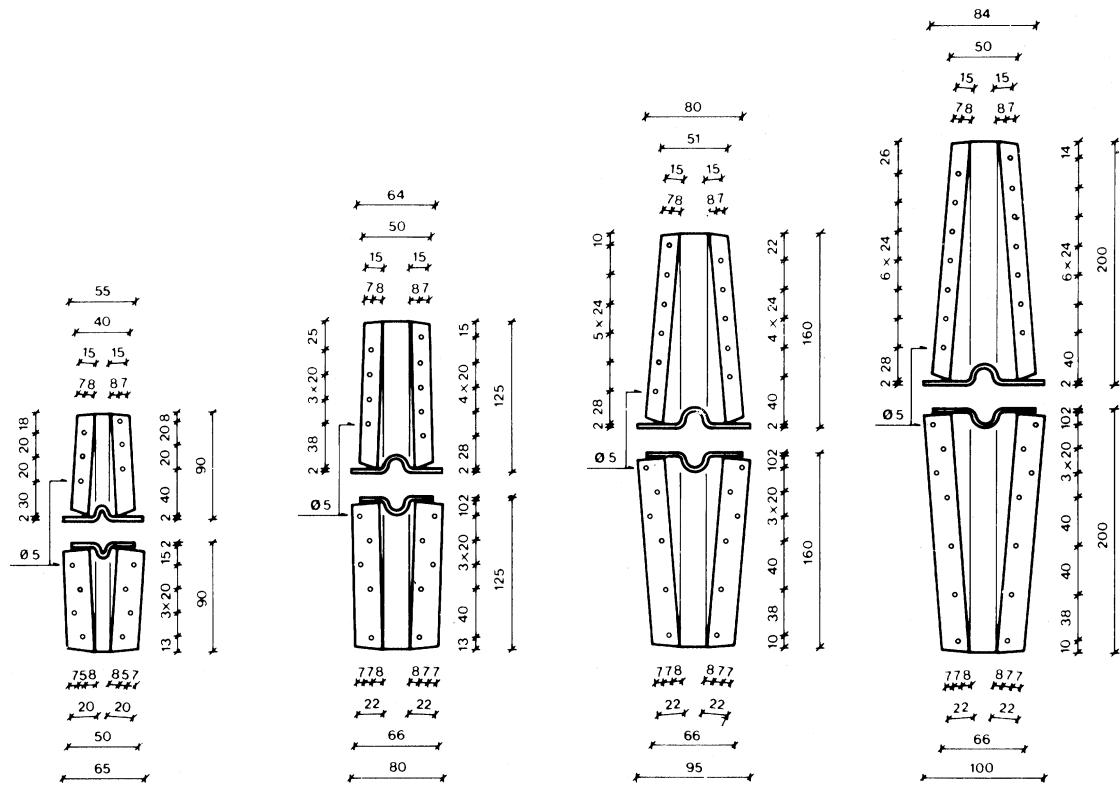

Figure D23-1 – KNAG 90, 130, 170 and 210

### Material:

Standard material: S250GD + Z275 according to EN 10346  
 Or stainless steel according to clause II-1



**Modified characteristic capacities:**

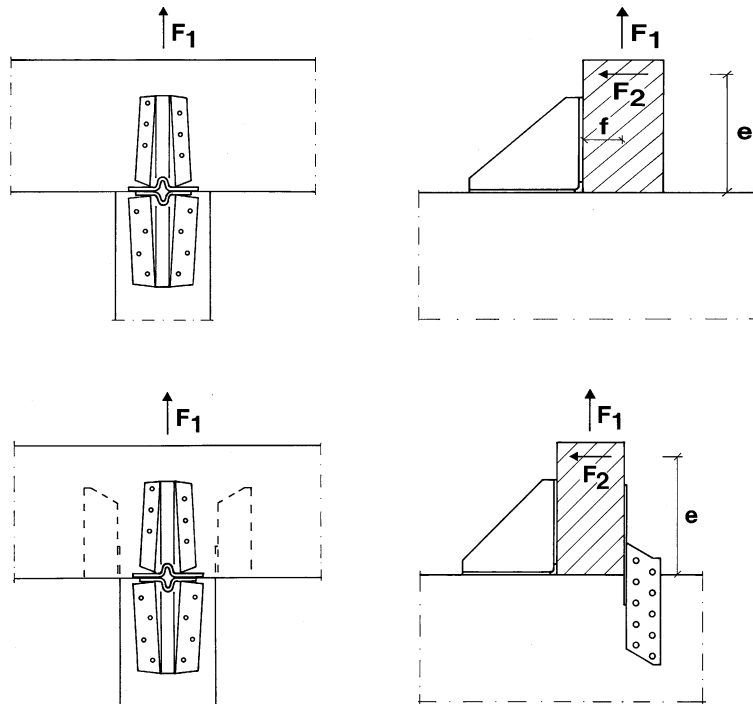

*One knight bracket per connection*

Acting forces

- $F_1$  Lifting force acting in the central axis of the angle bracket but in a distance  $f$  from the vertical flap of the knight bracket
- $F_2$  Lateral force acting in the beam direction perpendicular to the vertical flap elevated  $e$  above the beam directed towards the knight brackets vertical flap

*One knight bracket and one or two joist anchors per connection*

Acting forces

- $F_1$  Lifting force acting in the central axis of the knight bracket
- $F_2$  Lateral force acting in the beam direction perpendicular to the vertical flap elevated  $e$  above the beam directed towards the knight brackets vertical flap

*Wane*

Wane is not allowed under the knight bracket.

Table D23-1 KNAG - beam to beam connection - connector nails

1 Knight Bracket per connection	Modified characteristic capacity per connection	
Bracket type	$R_{1,k}$	$R_{2,k}$
90	$f \leq 36$ : $\frac{201}{36+f}$ $f > 36$ : $\frac{74}{f}$	$e \leq 17$ : $14,9-0,314e$ $17 < e \leq 133$ : $\frac{164}{e}$ $133 < e$ : $\frac{77}{e-70}$
130	$f \leq 52$ : $\frac{475}{94+f}$ $f > 52$ : $\frac{168}{f}$	$e \leq 41$ : $19,1-0,232e$ $41 < e \leq 176$ : $\frac{392}{e}$ $176 < e$ : $\frac{181}{e-94}$
170	$f \leq 75$ : $\frac{777}{128+f}$ $f > 75$ : $\frac{277}{f}$	$e \leq 70$ : $23,4-0,198e$ $70 < e \leq 222$ : $\frac{672}{e}$ $222 < e$ : $\frac{297}{e-124}$
210	$f \leq 99$ : $\frac{1183}{169+f}$ $f > 99$ : $\frac{438}{f}$	$e \leq 89$ : $27,7-0,182e$ $89 < e \leq 289$ : $\frac{1026}{e}$ $289 < e$ : $\frac{486}{e-152}$

e and f are in mm

Connector nails according to ETA-04/0013 CNA4,0x60 in the beam and CNA4,0x40 in the joist.

The capacities in the table are for short load duration, the capacities for other load durations are found by multiplication by the factor c

Factor c for other	P	L	M	S	I
	0,67	0,78	0,89	1,00	1,19

Table D23-1 KNAG - beam to beam connection - connector nails

1 Knight Bracket and 1 or 2 joist anchors per connection	Modified characteristic capacity per connection				
Bracket type	Joist width mm	Min. Anchor force kN	No. of nails in anchor and example of anchortype	$R_{1,k}$	$R_{2,k}$
90	50	7,5	8 nails 250	10,8	$e \leq 81$ : 11,9 $e > 81$ : <u>430</u> e-45
	80	6,0	7 nails 250	9,3	$e \leq 96$ : 11,9 $e > 96$ : <u>612</u> e-45
	100	5,5	7 nails 250	8,8	$e \leq 109$ : 11,9 $e > 109$ : <u>761</u> e-45
130	60	11,4	10 nails 290	16,4	$e \leq 106$ : 16,6 $e > 106$ : <u>703</u> e-64
	100	9,0	9 nails 290	14,0	$e \leq 128$ : 16,6 $e > 128$ : <u>1056</u> e-64
	140	7,9	9 nails 290	12,9	$e \leq 152$ : 16,6 $e > 152$ : <u>1469</u> e-64
170	60	19,9	2x10 nails 2x290	28,7	$e \leq 146$ : 21,4 $e > 146$ : <u>1406</u> e-80
	100	15,6	2x8 nails 2x250	24,4	$e \leq 159$ : 21,4 $e > 159$ : <u>1683</u> e-80
	140	13,7	2x7 nails 2x250	22,5	$e \leq 180$ : 21,4 $e > 180$ : <u>2129</u> e-80
210	80	25,2	2x11 nails 2x330	36,2	$e \leq 175$ : 26,3 $e > 175$ : <u>1930</u> e-102
	120	20,6	2x9 nails 2x290	31,7	$e \leq 198$ : 26,3 $e > 198$ : <u>2536</u> e-102
	160	18,3	2x9 nails 2x290	29,3	$e \leq 230$ : 26,3 $e > 230$ : <u>3365</u> e-102

e are in mm

Connector nails according to ETA-04/0013 CNA4,0x60 in the beam and CNA4,0x40 in the joist.

The capacities in the table are for short load duration, the capacities for other load durations are found by multiplication by the factor c

Factor c for other load durations	P	L	M	S	I
	0,67	0,78	0,89	1,00	1,19

## Annex D24 – ES10 and ES11

### Product Name:

Product Name	Alternative name			
	UK	France	Denmark	Germany
ES10	--	--	--	--
ES10IX	--	--	--	--
ES11	--	--	--	--

### Drawing:

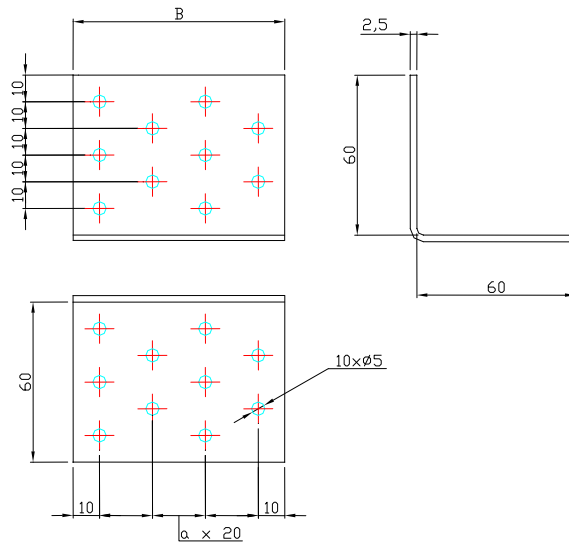
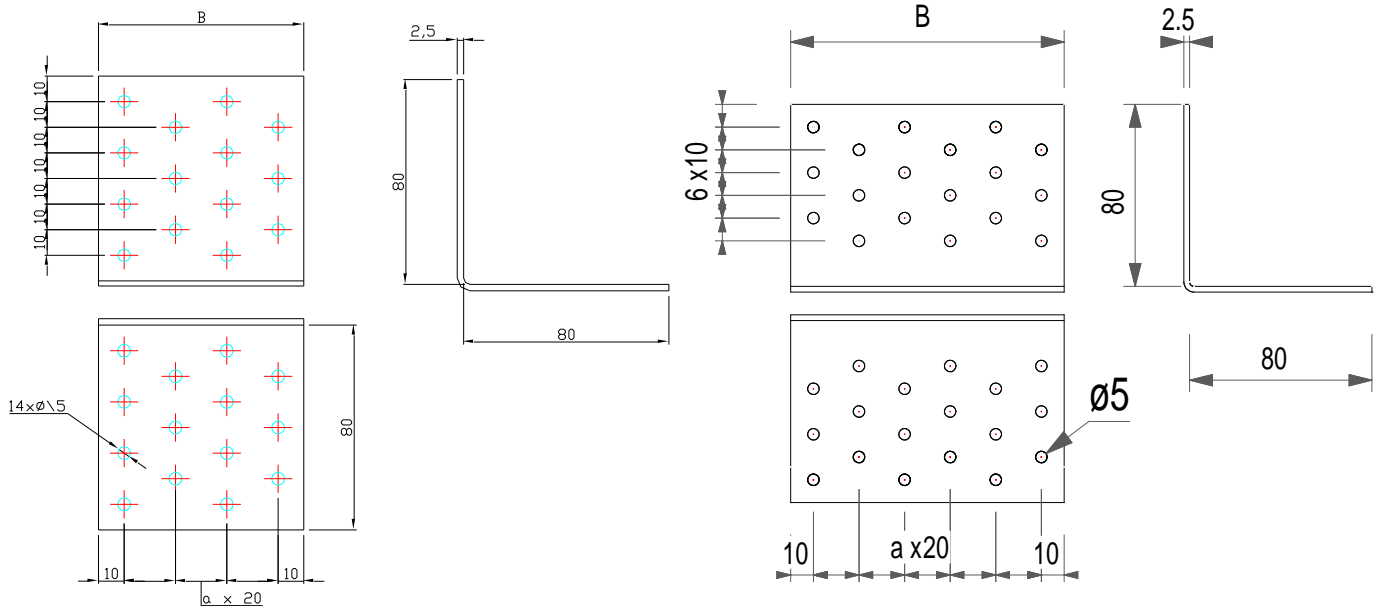

Figure D24-1 – ES10  
B from 40 to 160

Figure D24-2 – ES11  
B from 40 to 80

B from 100 to 200





**Material:**

Standard material : S250GD + Z275 according to EN 10346

Or stainless steel according to clause II-1

**Nail pattern:**

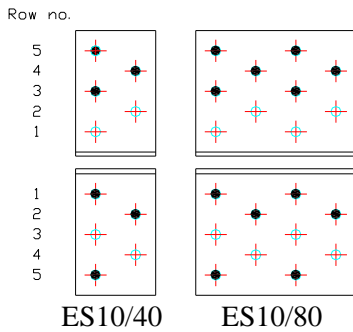

Figure D24-3 – ES10/40 to ES10/80

Beam to beam connection

Vertical flap: Nailing in row no. 3, 4 and 5

Horizontal flap: Nailing in row no. 1, 2 and 5

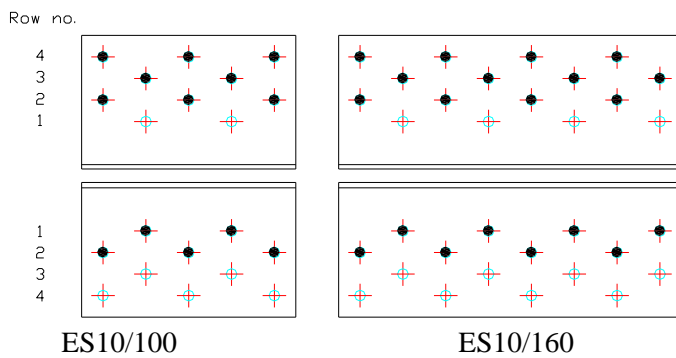

Figure D24-4 – ES10/100 to ES10/160

Beam to beam connection

Vertical flap: Nailing in row no. 2, 3 and 4

Horizontal flap: Nailing in row no. 1, and 2

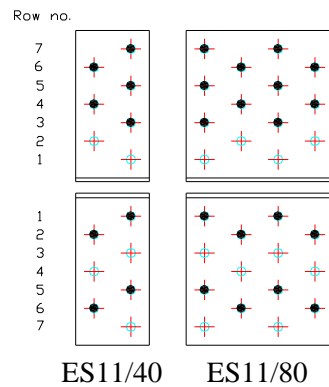

Figure D24-5 – ES11/40 to ES11/80

Beam to beam connection

Vertical flap: Nailing in row no. 3, 4, 5, 6 and 7

Horizontal flap: Nailing in row no. 1, 2, 5 and 6

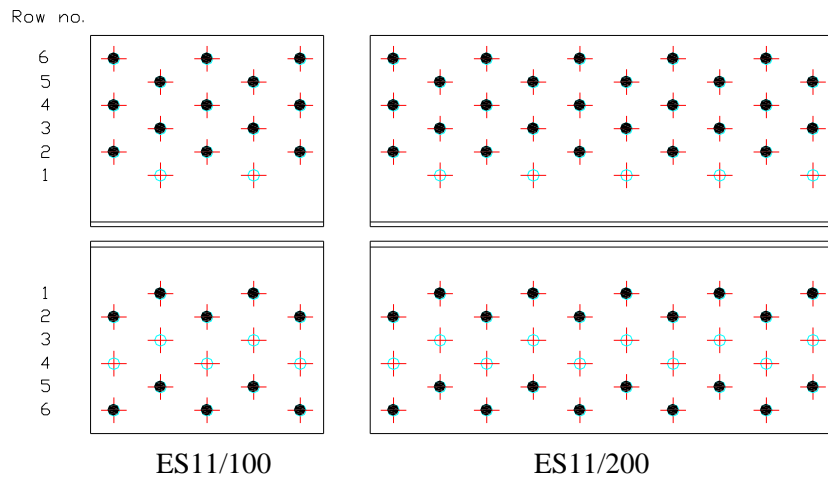

Figure D24-6 – ES11/100 to ES11/200

Beam to beam connection

Vertical flap: Nailing in row no. 2, 3, 4, 5, and 6

Horizontal flap: Nailing in row no. 1, 2, 5 and 6

**Modified characteristic capacities:**

Table D24-1 ES10- beam to beam connection - connector nails

2 Angle Brackets ES10/40 per connection	Modified characteristic capacity per connection (kN)					
	F <sub>1</sub>			F <sub>2</sub> =F <sub>3</sub>		
	Connector nails according to ETA-04/0013					
Load duration	4,0 x 35	4,0 x 50	4,0 x 60	4,0 x 35	4,0 x 50	4,0 x 60
P	1,5	2,4	2,6	1,4	1,9	2,1
L	1,7	2,6	2,7	1,7	2,2	2,4
M	2,0	2,6	3,2	1,9	2,6	2,7
S	2,2	2,8	3,7	2,2	2,9	3,1
I	2,6	3,6	4,5	2,6	3,5	3,8

2 Angle Brackets ES10/60 per connection	Modified characteristic capacity per connection (kN)					
	F <sub>1</sub>			F <sub>2</sub> =F <sub>3</sub>		
	Connector nails according to ETA-04/0013					
Load duration	4,0 x 35	4,0 x 50	4,0 x 60	4,0 x 35	4,0 x 50	4,0 x 60
P	2,2	3,5	4,4	3,4	4,5	4,8
L	2,6	4,1	4,4	3,9	5,2	5,6
M	2,9	4,4	4,8	4,5	6,0	6,4
S	3,3	4,4	5,6	5,1	6,7	7,2
I	4,0	5,4	7,0	6,2	8,2	8,8

2 Angle Brackets ES10/80 per connection	Modified characteristic capacity per connection (kN)					
	F <sub>1</sub>			F <sub>2</sub> =F <sub>3</sub>		
	Connector nails according to ETA-04/0013					
Load duration	4,0 x 35	4,0 x 50	4,0 x 60	4,0 x 35	4,0 x 50	4,0 x 60
P	2,9	4,7	5,2	4,4	5,8	6,2
L	3,4	5,2	5,4	5,1	6,8	7,3
M	3,9	5,2	6,4	5,8	7,8	8,3
S	4,4	5,6	7,4	6,6	8,7	9,3
I	5,2	7,2	9,1	8,0	10,7	11,4

2 Angle Brackets ES10/100 per connection	Modified characteristic capacity per connection (kN)					
	F <sub>1</sub>			F <sub>2</sub> =F <sub>3</sub>		
	Connector nails according to ETA-04/0013					
Load duration	4,0 x 35	4,0 x 50	4,0 x 60	4,0 x 35	4,0 x 50	4,0 x 60
P	3,7	3,7	4,7	6,1	8,2	8,7
L	3,7	4,3	6,0	7,2	9,5	10,2
M	3,7	5,2	6,4	8,2	10,9	11,6
S	3,7	6,2	6,4	9,2	12,2	13,1
I	4,1	6,4	6,4	11,2	15,0	16,0

2 Angle Brackets ES10/120 per connection	Modified characteristic capacity per connection (kN)					
	F <sub>1</sub>			F <sub>2</sub> =F <sub>3</sub>		
	Connector nails according to ETA-04/0013					
Load duration	4,0 x 35	4,0 x 50	4,0 x 60	4,0 x 35	4,0 x 50	4,0 x 60
P	4,4	4,6	5,8	7,5	10,0	10,6
L	4,6	5,2	7,3	8,7	11,6	12,4
M	4,6	6,4	8,0	10,0	13,3	14,1
S	4,6	7,6	8,0	11,2	14,9	15,9
I	5,1	8,0	8,0	13,7	18,2	19,4

2 Angle Brackets ES10/140 per connection	Modified characteristic capacity per connection (kN)					
	F <sub>1</sub>			F <sub>2</sub> =F <sub>3</sub>		
	Connector nails according to ETA-04/0013					
Load duration	4,0 x 35	4,0 x 50	4,0 x 60	4,0 x 35	4,0 x 50	4,0 x 60
P	5,2	5,2	6,7	10,0	13,4	14,2
L	5,2	6,0	8,4	11,7	15,6	16,6
M	5,2	7,4	9,1	13,4	17,8	19,0
S	5,2	8,7	9,1	15,1	20,0	21,4
I	5,8	9,1	9,1	18,4	24,5	26,1

2 Angle Brackets ES10/160 per connection	Modified characteristic capacity per connection (kN)					
	F <sub>1</sub>			F <sub>2</sub> =F <sub>3</sub>		
	Connector nails according to ETA-04/0013					
Load duration	4,0 x 35	4,0 x 50	4,0 x 60	4,0 x 35	4,0 x 50	4,0 x 60
P	5,9	6,1	7,7	11,4	15,2	16,2
L	6,1	7,0	9,7	13,3	17,8	18,9
M	6,1	8,5	10,6	15,2	20,3	21,6
S	6,1	10,1	10,6	17,2	22,8	24,3
I	6,8	10,6	10,6	21,0	27,9	29,8

Table D24-2 ES11- beam to beam connection - connector nails

2 Angle Brackets ES11/40 per connection	Modified characteristic capacity per connection (kN)					
	F <sub>1</sub>			F <sub>2</sub> =F <sub>3</sub>		
	Connector nails according to ETA-04/0013					
Load duration	4,0 x 35	4,0 x 50	4,0 x 60	4,0 x 35	4,0 x 50	4,0 x 60
P	1,5	2,4	2,6	2,1	2,8	3,0
L	1,7	2,6	2,7	2,5	3,3	3,5
M	2,0	2,6	3,2	2,8	3,7	4,0
S	2,2	2,8	3,7	3,1	4,2	4,5
I	2,6	3,6	4,5	3,8	5,1	5,5

<b>2 Angle Brackets ES11/60 per connection</b>	<b>Modified characteristic capacity per connection (kN)</b>					
Load duration	<b>F<sub>1</sub></b>			<b>F<sub>2</sub>=F<sub>3</sub></b>		
	Connector nails according to ETA-04/0013					
	4,0 x 35	4,0 x 50	4,0 x 60	4,0 x 35	4,0 x 50	4,0 x 60
P	2,2	3,5	4,4	4,4	5,9	6,3
L	2,6	4,1	4,4	5,2	6,9	7,3
M	2,9	4,4	4,8	5,9	7,9	8,4
S	3,3	4,4	5,6	6,7	8,9	9,4
I	4,0	5,4	7,1	8,1	10,8	11,5

<b>2 Angle Brackets ES11/80 per connection</b>	<b>Modified characteristic capacity per connection (kN)</b>					
Load duration	<b>F<sub>1</sub></b>			<b>F<sub>2</sub>=F<sub>3</sub></b>		
	Connector nails according to ETA-04/0013					
	4,0 x 35	4,0 x 50	4,0 x 60	4,0 x 35	4,0 x 50	4,0 x 60
P	2,9	4,7	5,2	6,1	8,1	8,7
L	3,4	5,2	5,5	7,1	9,5	10,1
M	3,9	5,2	6,5	8,1	10,8	11,5
S	4,4	5,7	7,4	9,1	12,2	13,0
I	5,2	7,2	9,1	11,2	14,9	15,9

<b>2 Angle Brackets ES11/100 per connection</b>	<b>Modified characteristic capacity per connection (kN)</b>					
Load duration	<b>F<sub>1</sub></b>			<b>F<sub>2</sub>=F<sub>3</sub></b>		
	Connector nails according to ETA-04/0013					
	4,0 x 35	4,0 x 50	4,0 x 60	4,0 x 35	4,0 x 50	4,0 x 60
P	3,7	4,2	5,6	8,8	11,7	12,5
L	3,7	5,1	6,4	10,2	13,6	14,5
M	3,7	6,1	6,4	11,7	15,6	16,6
S	3,8	6,4	6,4	13,2	17,5	18,7
I	5,0	6,4	6,4	16,1	21,4	22,8

<b>2 Angle Brackets ES11/120 per connection</b>	<b>Modified characteristic capacity per connection (kN)</b>					
Load duration	<b>F<sub>1</sub></b>			<b>F<sub>2</sub>=F<sub>3</sub></b>		
	Connector nails according to ETA-04/0013					
	4,0 x 35	4,0 x 50	4,0 x 60	4,0 x 35	4,0 x 50	4,0 x 60
P	4,4	5,0	6,8	10,4	13,9	14,8
L	4,6	6,2	8,0	12,2	16,2	17,3
M	4,6	7,3	8,0	13,9	18,5	19,8
S	4,6	8,0	8,0	15,7	20,9	22,2
I	6,0	8,0	8,0	19,1	25,5	27,2

<b>2 Angle Brackets ES11/140 per connection</b>	<b>Modified characteristic capacity per connection (kN)</b>					
Load duration	<b>F<sub>1</sub></b>			<b>F<sub>2</sub>=F<sub>3</sub></b>		
	Connector nails according to ETA-04/0013					
	4,0 x 35	4,0 x 50	4,0 x 60	4,0 x 35	4,0 x 50	4,0 x 60
P	5,2	5,8	7,8	14,1	18,8	20,0
L	5,2	7,2	9,1	16,5	21,9	23,4
M	5,2	8,6	9,1	18,8	25,0	26,7
S	5,3	9,1	9,1	21,2	28,2	30,0
I	7,0	9,1	9,1	25,9	34,4	36,7

<b>2 Angle Brackets ES11/160 per connection</b>	<b>Modified characteristic capacity per connection (kN)</b>					
Load duration	<b>F<sub>1</sub></b>			<b>F<sub>2</sub>=F<sub>3</sub></b>		
	Connector nails according to ETA-04/0013					
	4,0 x 35	4,0 x 50	4,0 x 60	4,0 x 35	4,0 x 50	4,0 x 60
P	5,9	6,6	9,0	16,2	21,6	23,0
L	6,1	8,2	10,6	18,9	25,2	26,8
M	6,1	9,8	10,6	21,6	28,7	30,7
S	6,1	10,6	10,6	24,3	32,3	34,5
I	8,0	10,6	10,6	29,7	39,5	42,2

<b>2 Angle Brackets ES11/180 per connection</b>	<b>Modified characteristic capacity per connection (kN)</b>					
Load duration	<b>F<sub>1</sub></b>			<b>F<sub>2</sub>=F<sub>3</sub></b>		
	Connector nails according to ETA-04/0013					
	4,0 x 35	4,0 x 50	4,0 x 60	4,0 x 35	4,0 x 50	4,0 x 60
P	6,6	7,5	10,1	20,4	27,2	29,1
L	6,7	9,2	11,7	23,9	31,8	33,9
M	6,7	11,0	11,7	27,3	36,3	38,7
S	6,8	11,7	11,7	30,7	40,9	43,6
I	9,0	11,7	11,7	37,5	49,9	53,3

<b>2 Angle Brackets ES11/200 per connection</b>	<b>Modified characteristic capacity per connection (kN)</b>					
Load duration	<b>F<sub>1</sub></b>			<b>F<sub>2</sub>=F<sub>3</sub></b>		
	Connector nails according to ETA-04/0013					
	4,0 x 35	4,0 x 50	4,0 x 60	4,0 x 35	4,0 x 50	4,0 x 60
P	7,4	8,3	11,2	22,8	30,4	32,4
L	7,6	10,3	13,3	26,7	35,5	37,8
M	7,6	12,2	13,3	30,5	40,6	43,3
S	7,6	13,3	13,3	34,3	45,7	48,7
I	10,0	13,3	13,3	41,9	55,8	59,5

## Annex D25 – LS

### Product Name:

Product Name	Alternative name			
	UK	France	Denmark	Germany
LS30	--	--	--	--
LS50	--	--	--	--
LS70	--	--	--	--
LS90	--	--	--	--

### Drawing:

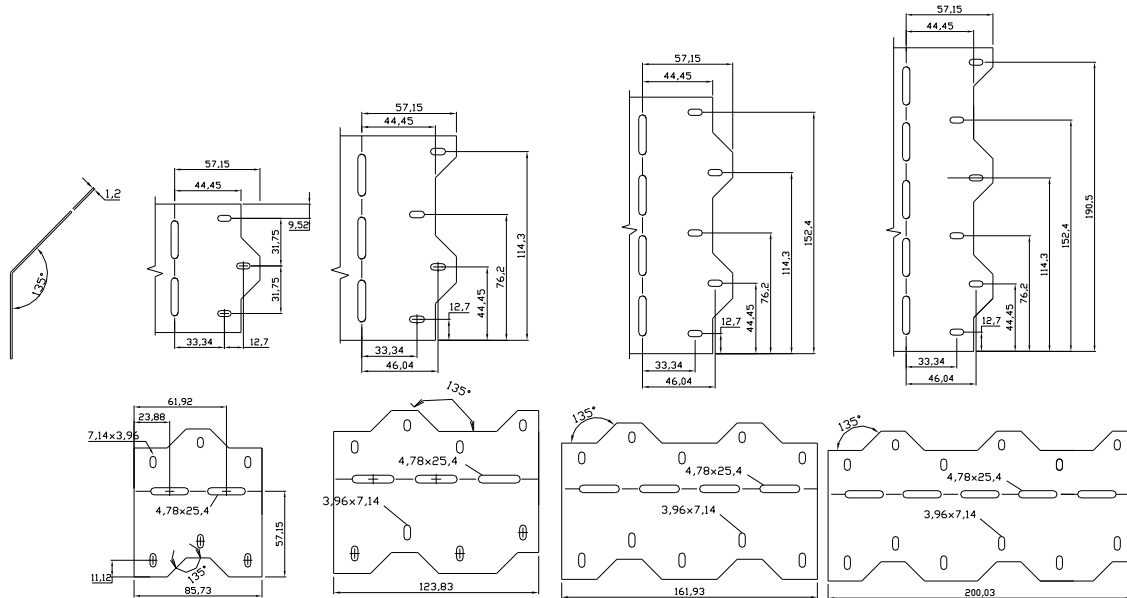

Figure D25-1: LS30 LS50 LS70 and LS90

### Material:

G90 SS Grade 33

### Nail pattern:

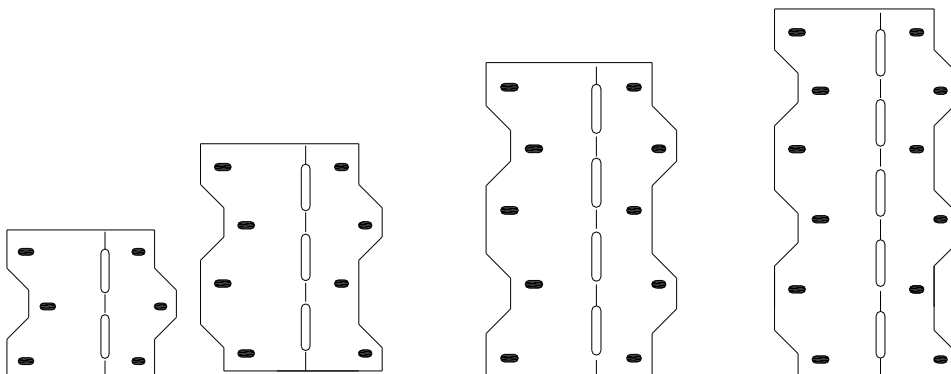

Figure D25-2 – LS30 LS50 LS70 and LS90  
Beam to beam connection  
Full nailing

**Design Basis:**

Figure D25-3 – Design basis

*One angle bracket per connection*

Acting forces

 $F_2=F_3$  The force is acting in the bending line of the angle bracket and parallel to it
**Modified characteristic capacities:**

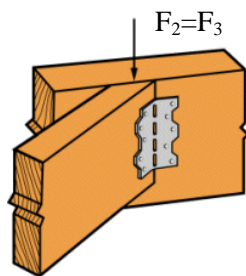
Table D25-1 LS - beam to beam connection - connector nails

1 Angle Bracket LS30 per connection	Modified characteristic capacity per connection (kN)	
	$F_2=F_3$	
Load duration	Round smooth nail 3,75 x 75	Connector nails according to ETA-04/0013 3,7 x 50
P	1,0	1,7
L	1,2	2,0
M	1,4	2,3
S	1,6	2,6
I	1,9	3,1

1 Angle Bracket LS50 per connection	Modified characteristic capacity per connection (kN)	
	$F_2=F_3$	
Load duration	Round smooth nail 3,75 x 75	Connector nails according to ETA-04/0013 3,7 x 50
P	1,6	2,6
L	1,8	3,0
M	2,1	3,4
S	2,4	3,9
I	2,9	4,7

1 Angle Bracket LS70 per connection	Modified characteristic capacity per connection (kN)	
	$F_2=F_3$	
Load duration	Round smooth nail 3,75 x 75	Connector nails according to ETA-04/0013 3,7 x 50
P	1,6	2,6
L	1,9	3,1
M	2,2	3,5
S	2,4	4,0
I	3,0	4,9

1 Angle Bracket LS90 per connection	Modified characteristic capacity per connection (kN)	
Load duration	$F_2=F_3$	
	Round smooth nail 3,75 x 75	Connector nails according to ETA-04/0013 3,7 x 50
P	1,9	3,1
L	2,2	3,7
M	2,6	4,2
S	2,9	4,7
I	3,5	5,8



## Annex D26 – TAZ

### Product Name:

Product Name	Alternative name			
	UK	France	Denmark	Germany
TA9Z	--	--	--	--
TA10Z	--	--	--	--

### Drawing:

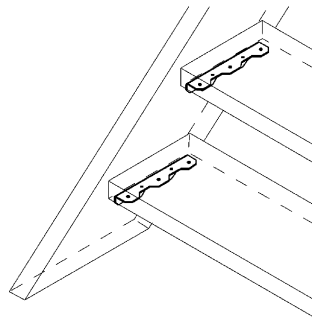

Figure D26-1: TAZ typical connection

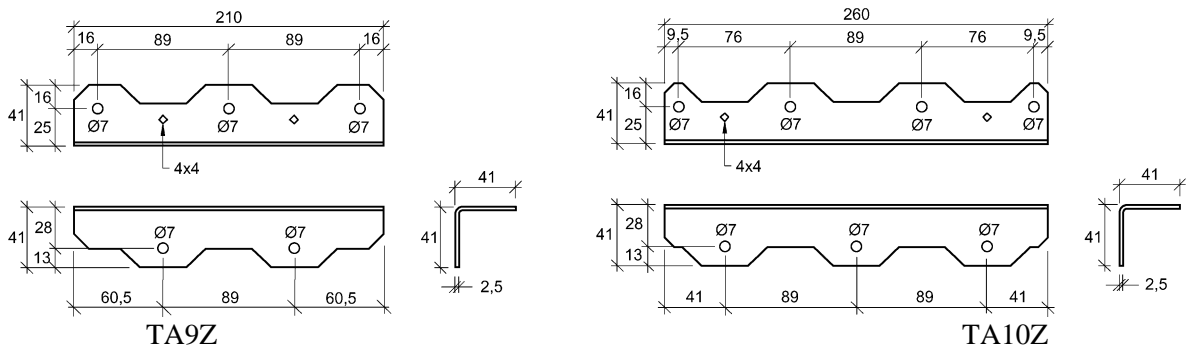

Figure D26-2: TAZ dimensions

### Material:

G185 SS Grade 33

### Nail pattern:

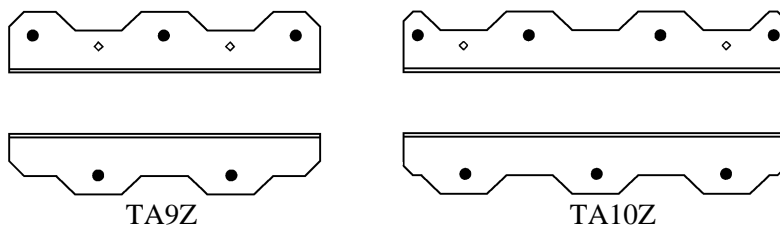

Figure D26-3: TAZ nail patterns

**Design Basis:**

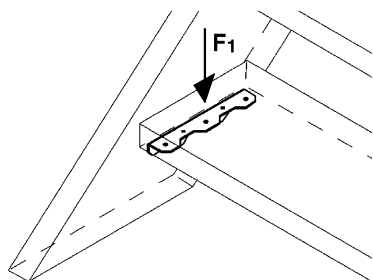

Figure D26-4 – Design basis

*One angle bracket per connection*

Acting forces

$F_1$  Downward force from the step acting close to the string

**Modified characteristic capacities:**

Table D26-1 TAZ - beam to beam connection

1 Angle Bracket per connection	Modified characteristic capacity per connection (kN)				
	Load duration				
Bracket type	P	L	M	S	I
TA9Z	3,8	4,5	5,2	5,9	7,3
TA10Z	5,1	6,0	6,9	7,9	9,7

Smooth shank screws 6,0 x 45 in pre-drilled holes.

**Product Name:**

Product Name	Alternative name			
	UK	France	Denmark	Germany
ABR170	--	--	--	--
ABR220	--	--	--	--

**Drawing:**

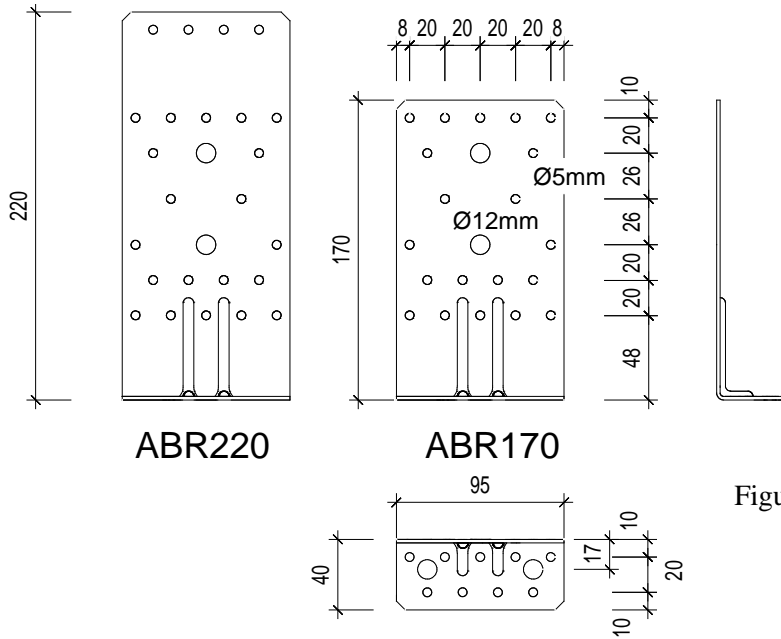

Figure D27-1 – ABR170 and ABR220

**Material:**

Standard material: S250GD + Z275 according to EN 10346 – 2 mm  
 Or stainless steel according to clause II-1

**Nail pattern:**

For a combination of different force directions, it's to use the nail pattern with the most nails.

$R_1$

$R_2 = R_2$

$R_4 = R_5$

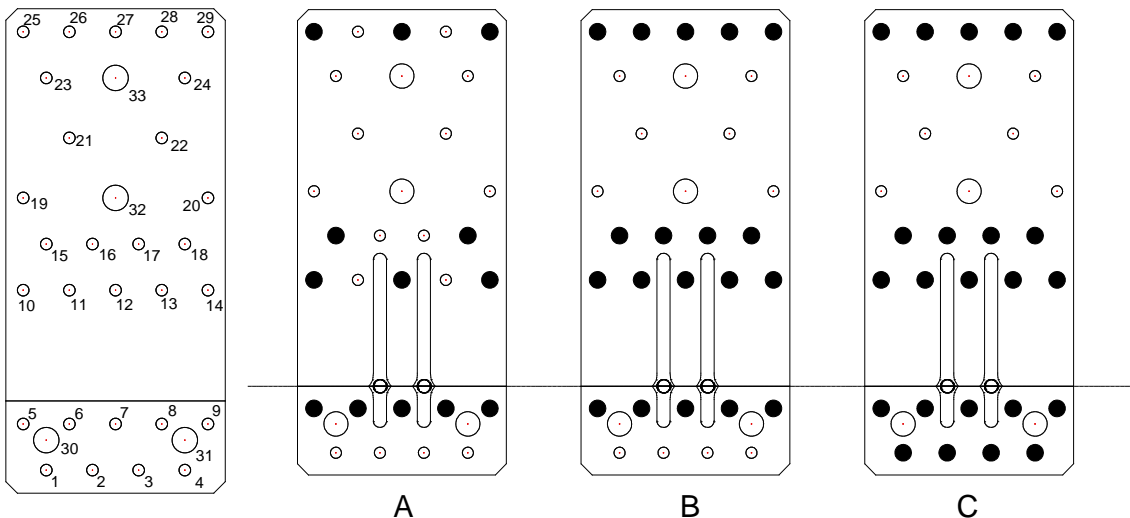

Figure D27-2 : ABR170 and ABR220 Nails patterns – Configuration A, B and C  
 Beam/column to beam connection

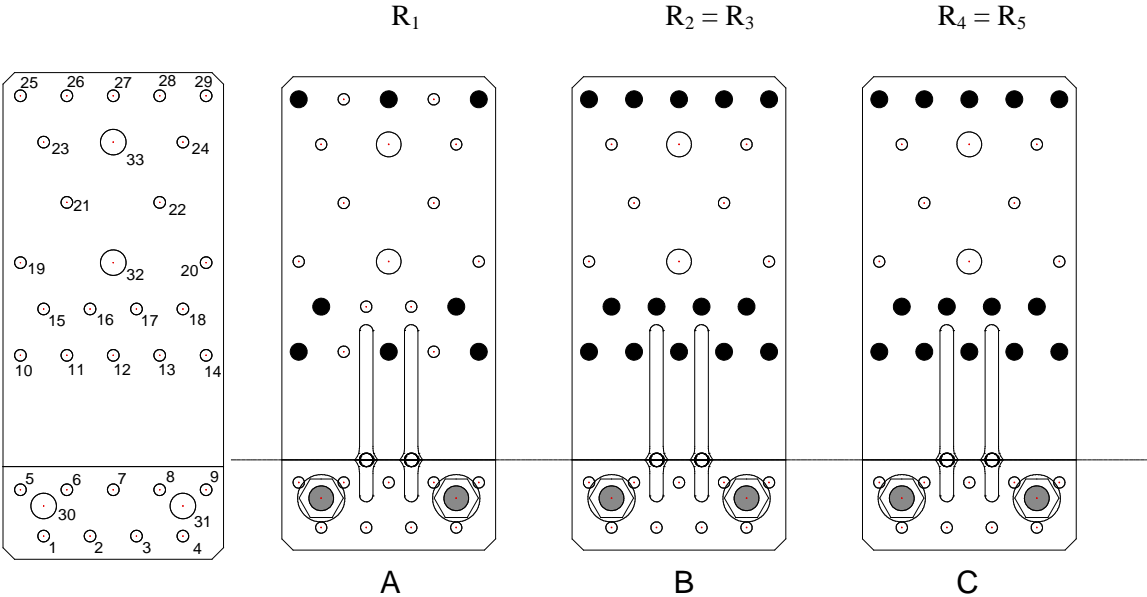

Figure D27-3 : ABR170 and ABR220 Nails patterns – Configuration A, B and C  
Beam/column to concrete connection

**Modified characteristic capacities:**

Table D27-1 ABR170 and ABR220 – beam/column to beam connection

2 Angle Brackets per connection	Characteristic capacity per connection [kN]		
	Connector nails according to ETA04/0013		
	CNA4,0x40	CNA4,0x50	CNA4,0x60
<b>Load duration: M</b>			
<b>R<sub>1,k</sub></b> 8+5 nails (fig.27-2 A)	5,9	7,8	9,8
<b>R<sub>2/3,k</sub></b> 14+5 nails (fig.27-2 B)	13,1	15,8	16,9
<b>R<sub>4/5,k</sub></b> 14x9 nails (fig.27-2 C)	8,0 with e ≤ 50mm b ≥ 36mm	8,0 with e ≤ 65mm b ≥ 36mm	8,0 with e ≤ 80mm b ≥ 36mm
	8,0 with e ≤ 90mm b ≥ 60mm	8,0 with e ≤ 120mm b ≥ 60mm	8,0 with e ≤ 150mm b ≥ 60mm

For a “b” between 36 and 60mm it may be possible to interpolate the size “e”

Table D27-2 ABR170 and ABR220 – beam/column to beam connection

1 Angle Brackets per connection	Characteristic capacity per connection [kN]		
	Connector nails according to ETA04/0013		
	CNA4,0x40	CNA4,0x50	CNA4,0x60
<b>Load duration: M</b>			
<b>R<sub>1,k</sub></b> 8+5 nails (fig.27-2 A)	2,9	3,9	4,9
<b>R<sub>2/3,k</sub></b> 14+5 nails (fig.27-2 B)	6,6	7,9	8,5
<b>R<sub>4,k</sub></b> 14x9 nails (fig.27-2 C)	0,7 with e ≤ 50 mm	0,7 with e ≤ 50 mm	0,7 with e ≤ 50 mm
<b>R<sub>4,k</sub></b> 14x9 nails (fig.27-2 C)	capacity for a connection, without rotation of purlin: 6,6		
<b>R<sub>5,k</sub></b> 14x9 nails (fig.27-2 C)	1,4 with e ≤ 50mm b ≥ 36mm	1,4 with e ≤ 65mm b ≥ 36mm	1,4 with e ≤ 80mm b ≥ 36mm
	1,4 with e ≤ 90mm b ≥ 60mm	1,4 with e ≤ 120mm b ≥ 60mm	1,4 with e ≤ 150mm b ≥ 60mm

For a “b” between 36 and 60mm it may be possible to interpolate the size “e”

Factors for other load durations	R <sub>1,k</sub>			R <sub>2/3,k</sub>	R <sub>4,k</sub>	R <sub>4,k</sub> <sup>1)</sup>	R <sub>5,k</sub>	R <sub>4/5,k</sub>
	CNA4,0x40	CNA4,0x50	CNA4,0x60	All sizes				
I multiply M by	1,38	1,33	1,23	1,38	1	1,38	1	1,31
S multiply M by	1,13	1,13	1,08	1,13	1	1,13	1	1,1
L multiply M by	0,88	0,88	0,88	0,88	1	0,88	1	0,9
P multiply M by	0,75	0,75	0,75	0,75	1	0,75	1	0,79

<sup>1)</sup> capacity for a connection, without rotation of purlin

**Characteristic capacities:**

Table D27-3 ABR170 and ABR220 – beam/column to rigid support connection

2 Angle Brackets per connection	Characteristic capacity [kN]		
	Connector nails according to ETA-04/0013		
	4,0x40	4,0x50	4,0x60
R <sub>1,k</sub> nailing 12+2 bolts (fig. 27-3 A)	$\min \left\{ \begin{array}{l} 33,0 \\ \frac{25,2}{k_{mod}} \end{array} \right.$	$\min \left\{ \begin{array}{l} 39,8 \\ \frac{25,2}{k_{mod}} \end{array} \right.$	$\frac{25,2}{k_{mod}}$
R <sub>2/3,k</sub> nailing 14+2 bolts (fig. 27-3 B)	19,71	$\min \left\{ \begin{array}{l} 23,8 \\ \frac{24,6}{k_{mod}} \end{array} \right.$	$\min \left\{ \begin{array}{l} 25,4 \\ \frac{24,6}{k_{mod}} \end{array} \right.$
R <sub>4/5,k</sub> Nailing 14+2 bolts (fig. 27-3 C)	the minimum of e is 50 mm		
	$\min \left\{ \begin{array}{l} 9,15 + \frac{80}{e \times k_{mod}} \\ \frac{6,3 \times b}{e \times k_{mod}} \end{array} \right.$		

for R <sub>1</sub> : R <sub>bolt,ax,d</sub> ≥ F <sub>1,d</sub> /n <sub>bolt</sub>
for R <sub>2/3</sub> : R <sub>bolt,lat,d</sub> ≥ F <sub>2/3,d</sub> /n <sub>bolt</sub>
it is to check for R <sub>4/5</sub> :
the bolt 1: R <sub>bolt,ax,d</sub> ≥ F <sub>4/5,d</sub> × e / (2xb)
the bolt 2: R <sub>bolt,lat,d</sub> ≥ F <sub>4/5,d</sub> /2
and: R <sub>4/5,d</sub> ≤ R <sub>1,d</sub> × b/(2xe)

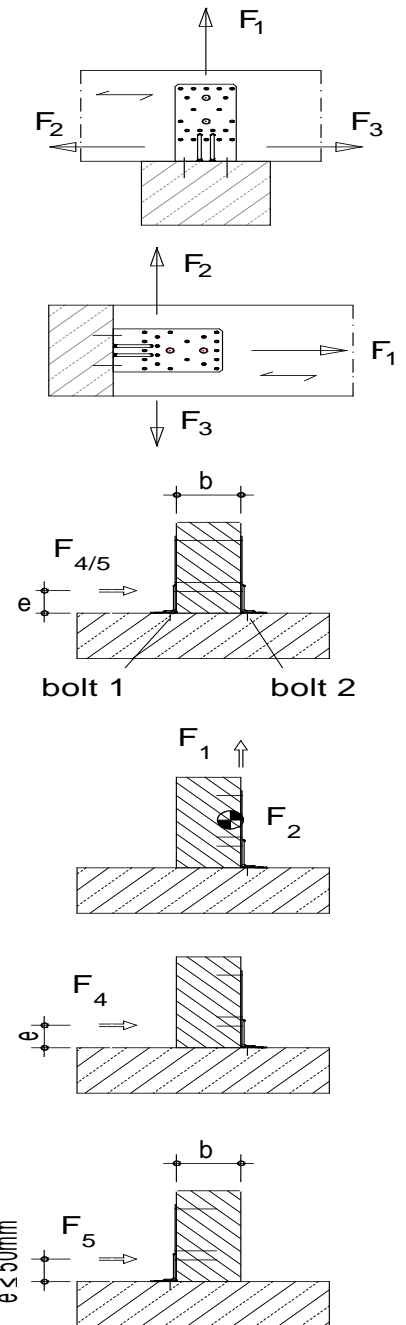

Table D27-4 ABR170 and ABR220 – beam/column to rigid support connection

1 Angle Brackets per connection	Characteristic capacity [kN]		
	Connector nails according to ETA-04/0013		
	4,0x40	4,0x50	4,0x60
R <sub>1,k</sub> nailing 12+2 bolts (fig. 27-3 A)	$\min \left\{ \begin{array}{l} 16,5 \\ \frac{12,6}{k_{mod}} \end{array} \right.$	$\min \left\{ \begin{array}{l} 19,9 \\ \frac{12,6}{k_{mod}} \end{array} \right.$	$\frac{12,6}{k_{mod}}$
R <sub>2/3,k</sub> nailing 14+2 bolts (fig. 27-3 B)	9,86	$\min \left\{ \begin{array}{l} 11,9 \\ \frac{12,3}{k_{mod}} \end{array} \right.$	$\min \left\{ \begin{array}{l} 12,7 \\ \frac{12,3}{k_{mod}} \end{array} \right.$
R <sub>4,k</sub> Nailing 14+2 bolts (fig. 27-3 C)	e < 100mm	$\frac{50}{e \times k_{mod}}$	
	e ≥ 100mm	$\frac{36}{e \times k_{mod}}$	
R <sub>5,k</sub> Nailing 14+2 bolts (fig. 27-3 C)	max e ≤ 50mm	$\frac{1,8}{k_{mod}}$	

for R <sub>1</sub> : $R_{\text{bolt,ax,d}} \geq F_{1,d}/n_{\text{bolt}}$
for R <sub>2/3</sub> : $R_{\text{bolt,lat,d}} \geq F_{2/3,d}/n_{\text{bolt}}$
it is to check for R <sub>4/5</sub> :
$R_{\text{bolt,ax,d}} \geq F_{5,d} \times e / (2xb)$
$R_{\text{bolt,ax,d}} \geq F_{4,d} \times e / 30$
$R_{\text{bolt,lat,d}} \geq F_{4/5,d} / 2$

In case of combined force the relevant of the following inequalities shall be fulfilled:

$$\left( \frac{F_{1,d}}{R_{1,d}} + \frac{F_{4/5,d}}{R_{4/5,d}} \right)^2 + \left( \frac{F_{2/3,d}}{R_{2,3,d}} \right) \leq 1$$

For F<sub>4/5</sub> can be use also F<sub>4</sub> or F<sub>5</sub> too, also for F<sub>2/3</sub> can be use F<sub>2</sub> or F<sub>3</sub> too.

## Annex D28 – AB6983

### Product Name:

Product Name	Alternative name			
	UK	France	Denmark	Germany
AB6983	--	--	--	--

### Drawing:

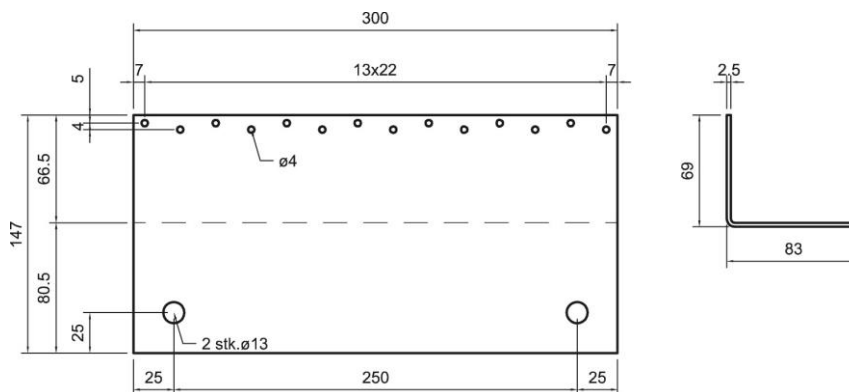

Figure D28-1: AB6983

### Material:

S250GD + Z275 according to EN 10346

### Nail pattern:

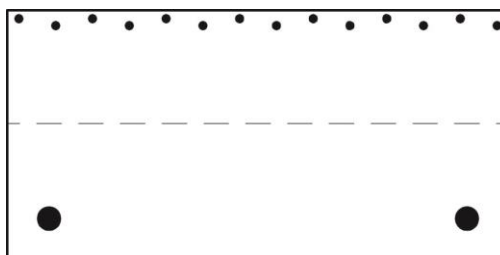

Figure D28-2: AB6983 nail pattern

### Modified characteristic capacities:

Modified characteristic capacity per connection (one shear connector per connection):

$$R_{2k} = R_{3k} = \min \begin{cases} R_{lat,nail,k} \times 9,29 \\ R_{lat,bolt,k} \times 2,14 / k_{mod} \end{cases}$$

The capacity of the connection between the bolts and concrete has to be checked separately  
Fasteners: 14 threaded nails 3,1x l and 2 bolts Ø12 mm. (Figure D28-2)

$R_{lat,nail,k}$  = Characteristic lateral capacity of 1 threaded nail 3,1x l

$R_{lat,bolt,k}$  = Characteristic lateral capacity of 1 M12 bolt. Max. 7,5 kN

$k_{mod}$  = Strength modification factor for service class and load-duration class according to Eurocode 5.



**Annex D29 – AB36125**

**Product Name:**

Product Name	Alternative name			
	UK	France	Denmark	Germany
AB36125	--	--	--	--

**Drawing:**

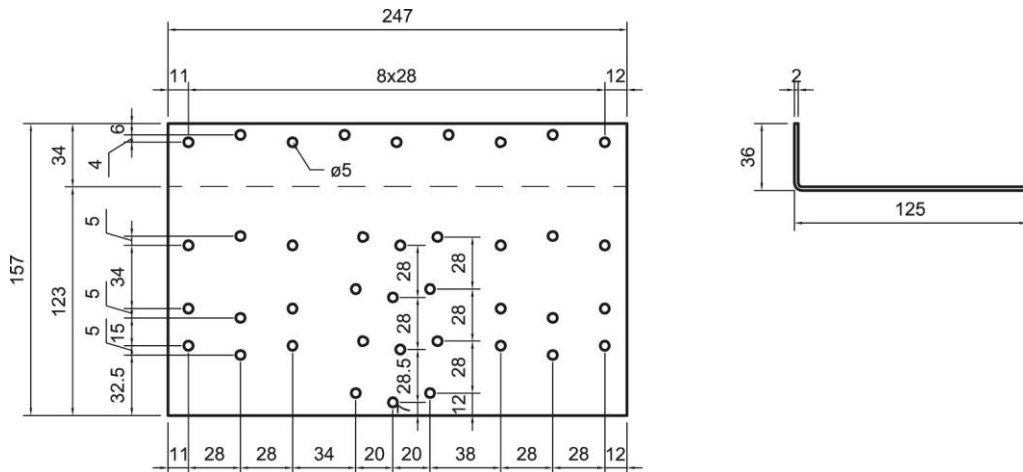

Figure D29-1: AB36125

**Material:**

S250GD + Z275 according to EN 10346

**Nail pattern:**

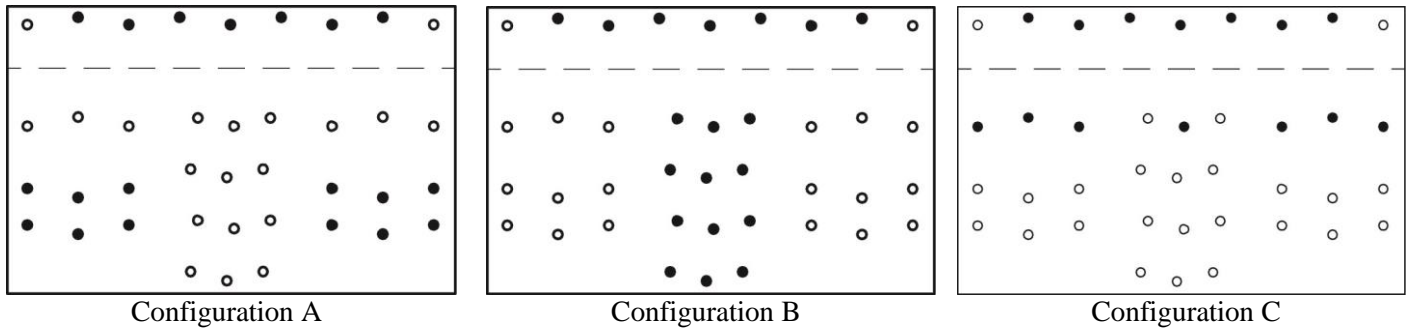

Figure D29-2: AB36125 Timber to timber nail pattern

**Modified characteristic capacities:**

Modified characteristic capacity per connection (one shear connector per connection) :

Fasteners: 7 + 12 threaded nails 4,0x *l*. Nail pattern A (Figure D29-2)

$$R_{2k} = R_{3k} = \min \left\{ \begin{array}{l} R_{lat,nail-v,k} \times 5,60 \\ R_{lat,nail-h,k} \times 8,57 \end{array} \right.$$

Fasteners: 7 + 12 threaded nails 4,0x *l*. Nail pattern B (Figure D29-2)

$$R_{2k} = R_{3k} = \min \left\{ \begin{array}{l} R_{lat,nail-v,k} \times 5,60 \\ R_{lat,nail-h,k} \times 6,04 \text{ -- } k_{mod} \text{ changed} \end{array} \right.$$

$R_{lat,nail-v,k}$  = Characteristic lateral capacity of 1 threaded nail 4,0x *l* in the vertical flap

$R_{lat,nail-h,k}$  = Characteristic lateral capacity of 1 threaded nail 4,0x *l* in the horizontal flap

$k_{mod}$  = Strength modification factor for service class and load-duration class according to Eurocode 5.

Fasteners: 7 + 7 threaded nails 4,0x *l*. Nail pattern C (Figure D29-2)

$$R_{2k} = R_{3k} = \min \left\{ \begin{array}{l} R_{lat,nail-v,k} \times 5,60 \\ R_{lat,nail-h,k} \times 6,12 \text{ -- } k_{mod} \text{ changed} \end{array} \right.$$

$R_{lat,nail-v,k}$  = Characteristic lateral capacity of 1 threaded nail 4,0x *l* in the vertical flap

$R_{lat,nail-h,k}$  = Characteristic lateral capacity of 1 threaded nail 4,0x *l* in the horizontal flap

$k_{mod}$  = Strength modification factor for service class and load-duration class according to Eurocode 5.

**Annex D30 – BNV33**

**Product Name:**

Product Name	Alternative name			
	UK	France	Denmark	Germany
BNV33	--	--	--	--

**Drawing:**

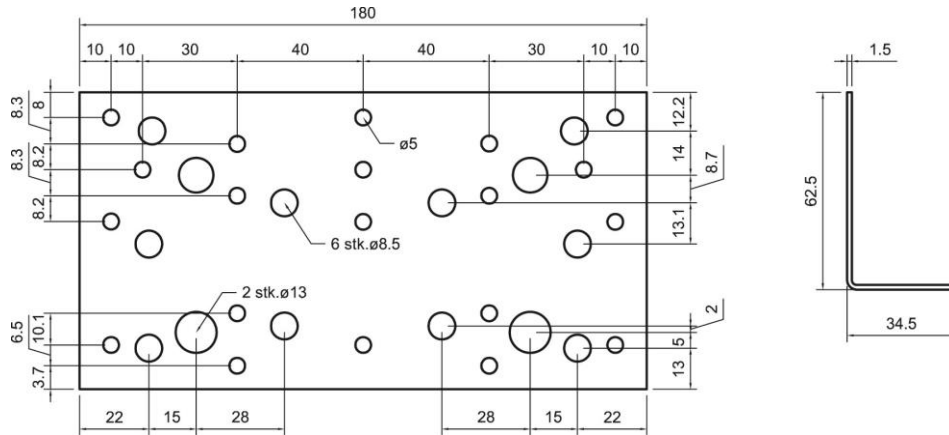

Figure D30-1: BNV33

**Material:**

S250GD + Z275 according to EN 10346

**Nail pattern:**

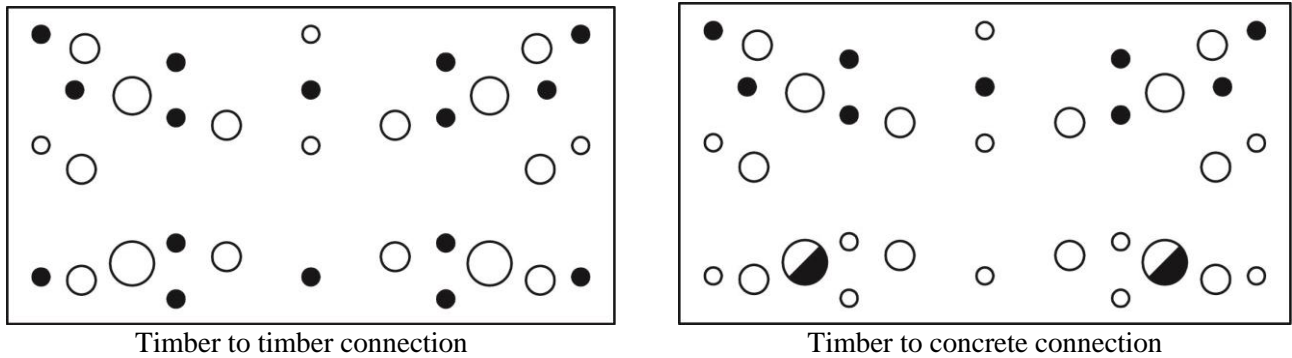

Figure D30-2: BNV33 fastener pattern

**Modified characteristic capacities:**

*One shear connector per connection. Timber/timber connection*

Fasteners: 9+7 threaded nails 4,0x l. (Figure D30-2)

Modified characteristic capacity per connection:

$$R_{2k} = R_{3k} = \min. \begin{cases} R_{lat,nail-v,k} \times 5,82 \\ R_{lat,nail-h,k} \times 6,26 \end{cases} \text{ -- } k_{mod} \text{ changed}$$

$R_{lat,nail-v,k}$  = Characteristic lateral capacity of 1 threaded nail 4,0x l in the vertical flap

$R_{lat,nail-h,k}$  = Characteristic lateral capacity of 1 threaded nail 4,0x l in the horizontal flap

$k_{mod}$  = Strength modification factor for service class and load-duration class according to Eurocode 5.

*One shear connector per connection. Timber/concrete connection*

Fasteners: 9 threaded nails 4,0x l and 2 bolts Ø12 mm (Figure D30-3)

Modified characteristic capacity per connection:

$$R_{2k} = R_{3k} = \min. \begin{cases} R_{lat,nail,k} \times 5,82 \\ R_{lat,bolt,k} \times 2,24 / k_{mod} \end{cases} \text{ -- } k_{mod} \text{ changed}$$

The capacity of the connection between the bolts and concrete has to be checked separately

$R_{lat,nail,k}$  = Characteristic lateral capacity of 1 threaded nail 4,0x l

$R_{lat,bolt,k}$  = Characteristic lateral capacity of 1 M12 bolt. Max. 4,5 kN

$k_{mod}$  = Strength modification factor for service class and load-duration class according to Eurocode 5.

**Annex D31 – E5/1.5**

**Product Name:**

Product Name	Alternative name			
	UK	France	Denmark	Germany
E5/1.5	--	--	--	--
E5/1.5/11.22/11	--	--	--	--
E5/1.5/13	--	--	--	--
E5IX/1.5/122/11	--	--	--	--

**Drawing:**

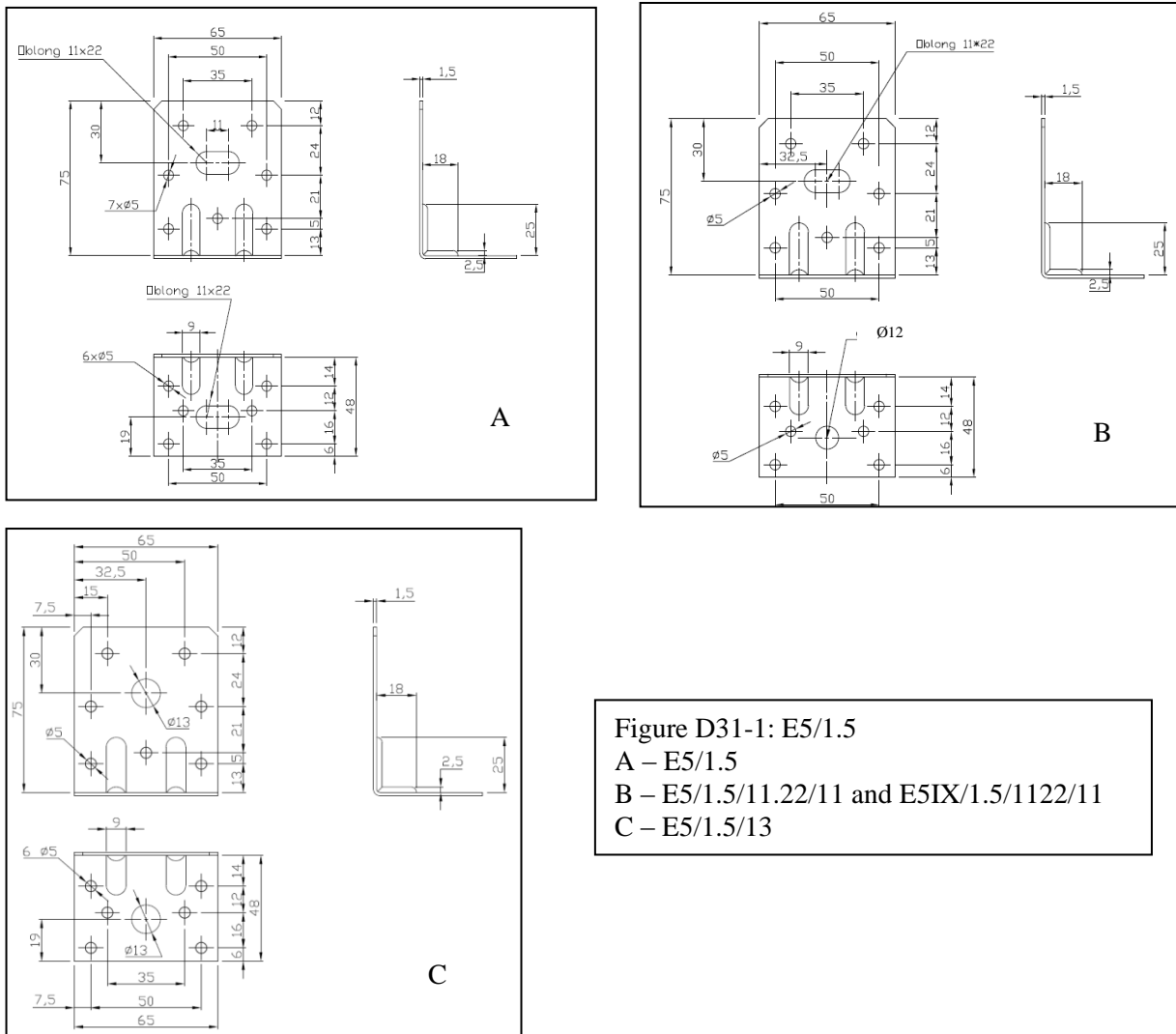

Figure D31-1: E5/1.5  
 A – E5/1.5  
 B – E5/1.5/11.22/11 and E5IX/1.5/122/11  
 C – E5/1.5/13

**Material**

S250GD + Z275 according to EN 10346

Except for E5IX/1.5/122/11 which is made of Stainless steel 316L according to EN 10088-2

**Nail pattern:**

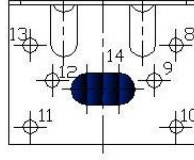
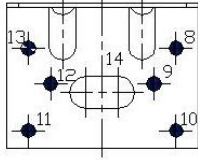
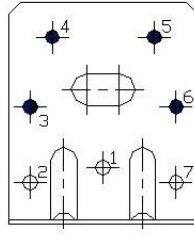
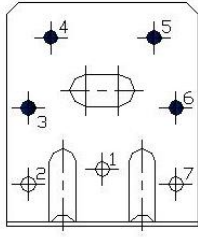

A

B

Timber to timber connection

Timber to concrete connection

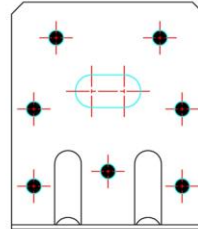
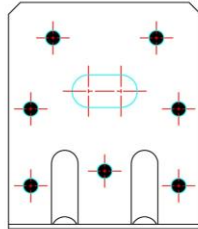

C

D

timber to timber

timber to rigid support

Figure D31-2: E5/1.5 nails pattern

**Modified characteristic capacities:**

Table D31-1 E5/1.5 - timber to timber connection – 1 angle bracket (nail pattern A)

The capacities given in the table below are valid for E5/1.5, E5/1.5/11.22/11 and E5IX/1.5/1122/11

Beam to beam connection				Characteristic capacity per connection (kN)				
Load duration	R <sub>1,k</sub>		R <sub>2,k</sub> = R <sub>3,k</sub>		R <sub>4,k</sub>		R <sub>5,k</sub>	
	Connector nail according to ETA-04/0013:							
	4,0x35	4,0x60	4,0x35	4,0x60	4,0x35	4,0x60	4,0x35	4,0x60
<b>P</b>	$f \leq 6,7$ $28 / (f + 46)$	$f \leq 3,3$ $57 / (f + 46)$	1,5	2,5	Min of $20/(e - 1,5)$ $23/\sqrt{(e^2 + 25)}$	Min of $20/(e - 1,5)$	/	/
	$f > 6,7$ $4 / (f + 1)$	$f > 3,3$ $4 / (f + 1)$			3,6 $7,4/(e - 26)$	3,6 $7,4/(e - 26)$		
<b>L</b>	$f \leq 5,5$ $33 / (f + 46)$	$f \leq 2,7$ $67 / (f + 46)$	1,7	2,9	Min of $20/(e - 1,5)$ $28/\sqrt{(e^2 + 25)}$	Min of $20/(e - 1,5)$	/	/
	$f > 5,5$ $4 / (f + 1)$	$f > 2,7$ $4 / (f + 1)$			4 $7,4/(e - 26)$	4 $7,4/(e - 26)$		
<b>M</b>	$f \leq 4,6$ $38 / (f + 46)$	$f \leq 2,2$ $76 / (f + 46)$	2	3,3	Min of $20/(e - 1,5)$ $32/\sqrt{(e^2 + 25)}$	Min of $20/(e - 1,5)$	/	/
	$f > 4,6$ $4 / (f + 1)$	$f > 2,2$ $4 / (f + 1)$			4,1 $7,4/(e - 26)$	4,1 $7,4/(e - 26)$		
<b>S</b>	$f \leq 3,9$ $43 / (f + 46)$	$f \leq 1,9$ $86 / (f + 46)$	2,2	3,8	Min of $20/(e - 1,5)$ $36/\sqrt{(e^2 + 25)}$	Min of $20/(e - 1,5)$	/	/
	$f > 3,9$ $4 / (f + 1)$	$f > 1,9$ $4 / (f + 1)$			4,4 $7,4/(e - 26)$	4,4 $7,4/(e - 26)$		
<b>I</b>	$f \leq 3$ $52 / (f + 46)$	$f \leq 1,4$ $105 / (f + 46)$	2,7	4,6	Min of $20/(e - 1,5)$ $44/\sqrt{(e^2 + 25)}$	Min of $20/(e - 1,5)$	/	/
	$f > 3$ $4 / (f + 1)$	$f > 1,4$ $4 / (f + 1)$			4,9 $7,4/(e - 26)$	4,9 $7,4/(e - 26)$		

e and f in mm

Table D31-2 E5/1.5 - timber to timber connection – 2 angle brackets (nail pattern A)

The capacities given in the table below are valid for E5/1.5, E5/1.5/11.22/11 and E5IX/1.5/1122/11

Beam to beam connection				Modified characteristic capacity per connection (kN)			
Load duration	R <sub>1,k</sub>		R <sub>2,k</sub> = R <sub>3,k</sub>		R <sub>4,k</sub> = R <sub>5,k</sub>		
	Connector nail according to ETA-04/0013:						
	4,0x35	4,0x60	4,0x35	4,0x60	4,0x35	4,0x60	
P	2,5	5,0	3,0	4,9	$e \leq 0,32 * b + 15$ 3,9	$e \leq 0,54 * b + 19$ 3,9	
					$e > 0,32 * b + 15$ $0,74 * (1,70 * b + 75)$ /(e-1,5)	$e > 0,54 * b + 19$ $0,87 * (2,89 * b + 92)$ /(e-1,5)	
L	3,0	5,6	3,5	5,8	$e \leq 0,34 * b + 15$ 4,3	$e \leq 0,56 * b + 18$ 4,3	
					$e > 0,34 * b + 15$ $0,74 * (1,98 * b + 79)$ /(e-1,5)	$e > 0,56 * b + 18$ $0,87 * (3,26 * b + 98)$ /(e-1,5)	
M	3,3	6,2	3,9	6,6	$e \leq 0,37 * b + 15$ 4,6	$e \leq 0,57 * b + 18$ 4,6	
					$e > 0,37 * b + 15$ $0,74 * (2,26 * b + 83)$ /(e-1,5)	$e > 0,57 * b + 18$ $0,87 * (3,55 * b + 102)$ /(e-1,5)	
S	3,7	6,7	4,4	7,5	$e \leq 0,39 * b + 15$ 4,8	$e \leq 0,59 * b + 18$ 4,8	
					$e > 0,39 * b + 15$ $0,74 * (2,54 * b + 87)$ /(e-1,5)	$e > 0,59 * b + 18$ $0,87 * (3,84 * b + 107)$ /(e-1,5)	
I	4,6	7,7	5,5	9,2	$e \leq 0,43 * b + 15$ 5,4	$e \leq 0,61 * b + 17$ 5,4	
					$e > 0,43 * b + 15$ $0,74 * (3,11 * b + 96)$ /(e-1,5)	$e > 0,61 * b + 17$ $0,87 * (4,43 * b + 116)$ /(e-1,5)	

e and f in mm



Table D31-3 E5/1.5 - timber to rigid support connection – 1 angle bracket (nail pattern B)

The capacities given in the table below are valid for E5/1.5, E5/1.5/11.22/11 and E5IX/1.5/1122/11

Beam to rigid support connection			Modified characteristic capacity per connection (kN)					
Load duration	R <sub>1,k</sub>		R <sub>2,k</sub> = R <sub>3,k</sub>		R <sub>4,k</sub>		R <sub>5,k</sub>	
	4,0x35	4,0x60	4,0x35	4,0x60	4,0x35	4,0x60	4,0x35	4,0x60
<b>P</b>	Min of 12,1/ ( f + 24 ) 4,1 / f		0,6	1,1	Min of 36,3 / e 8 / ( e - 26 ) 12,9		/	/
<b>L</b>			0,8	1,3			/	/
<b>M</b>			0,9	1,5			/	/
<b>S</b>			1,1	1,7			/	/
<b>I</b>			1,2	2,1			/	/

e and f in mm

Note: For R<sub>1,k</sub>, if the purlin is prevented from rotation, consider the value as the half of the one given for two brackets.For R<sub>4,k</sub> if the purlin is prevented from rotation, consider the value given for two brackets for e=0.

Requirement for the bolts – see declaration under table D31-6

Table D31-4 E5/1.5 - timber to rigid support connection – 2 angle brackets (nail pattern B)

The capacities given in the table below are valid for E5/1.5, E5/1.5/11.22/11 and E5IX/1.5/1122/11

Beam to rigid support connection				Modified characteristic capacity per connection (kN)			
Load duration	R <sub>1,k</sub>		R <sub>2,k</sub> = R <sub>3,k</sub>		R <sub>4,k</sub> = R <sub>5,k</sub>		
	Connector nail according to ETA-04/0013:						
	4,0x35	4,0x60	4,0x35	4,0x60	4,0x35	4,0x60	
P	2,3	4,4	1,3	2,0	e ≤ 0,26 * b + 21 4,4	e ≤ 0,42 * b + 25 4,4	
					e > 0,26 * b + 21 0,74*(1,54*b+107) /(e-1,5)	e > 0,42 * b + 25 0,87*(2,53*b+132) /(e-1,5)	
L	2,7	5,1	1,6	2,6	e ≤ 0,28 * b + 20 4,8	e ≤ 0,46 * b + 25 4,8	
					e > 0,28 * b + 20 0,74*(1,80*b+114) /(e-1,5)	e > 0,46 * b + 25 0,87*(2,96*b+143) /(e-1,5)	
M	3,0	5,5	1,8	3,0	e ≤ 0,30 * b + 20 5,1	e ≤ 0,49 * b + 25 5,1	
					e > 0,30 * b + 20 0,74*(2,05*b+120) /(e-1,5)	e > 0,49 * b + 25 0,87*(3,38*b+153) /(e-1,5)	
S	3,4	5,5	2,1	3,3	e ≤ 0,31 * b + 20 5,5	e ≤ 0,52 * b + 25 5,5	
					e > 0,31 * b + 20 0,74*(2,31*b+126) /(e-1,5)	e > 0,52 * b + 25 0,87*(3,80*b+154) /(e-1,5)	
I	4,1	5,5	2,5	4,1	e ≤ 0,35 * b + 20 6,0	e ≤ 0,57 * b + 26 6,0	
					e > 0,35 * b + 20 0,74*(2,82*b+139) /(e-1,5)	e > 0,57 * b + 26 0,87*(4,65*b+185) /(e-1,5)	

e and f in mm

Note: Value given for a withdrawal characteristic capacity of the bolt of 16 kN. For others bolt withdrawal capacities $R_{k,anchor}$  [kN], value must be limited by  $13.6 * R_{k,anchor} / 16$ .

Requirement for the bolts – see declaration under table D31-5

Table D31-5 E5/1.5/13 - timber to rigid support connection – 1 angle bracket (nail pattern B)

Beam to rigid support connection			Modified characteristic capacity per connection (kN)					
Load duration	R <sub>1,k</sub>		R <sub>2,k</sub> = R <sub>3,k</sub>		R <sub>4,k</sub>		R <sub>5,k</sub>	
	4,0x35	4,0x60	4,0x35	4,0x60	4,0x35	4,0x60	4,0x35	4,0x60
P	Min of 13,6 / ( f + 23) 5,2 / f		0,6	1	Min of 36,3 / e 8 / ( e -26 ) 19,3		/	/
L			0,8	1,3			/	/
M			0,9	1,5			/	/
S			1,1	1,7			/	/
I			1,2	2,1			/	/

Note: For R<sub>1,k</sub>, if the purlin is prevented from rotation, consider the value as the half of the one given for two brackets.  
For R<sub>4,k</sub> if the purlin is prevented from rotation, consider the value given for two brackets for e=0.

E5/1,5	connection with 2 angle brackets			
factor:	for F <sub>1</sub>	for F <sub>2/3</sub>	for F <sub>4/5</sub> , bolt 1	for F <sub>4/5</sub> , bolt 2
k <sub>ax</sub>	0,98	0,23	1,96 x e/(b+25)	-
k <sub>lat</sub>	-	0,50	-	1,00

For each bolt it's needed to check:  $R_{\text{bolt,d,lateral}} \geq k_{\text{lat}} \times F_{i,d}$  ;  $R_{\text{bolt,d,axial}} \geq k_{\text{ax}} \times F_{i,d}$  ; and also the combination

Table D31-6 E5/1.5/13 - timber to rigid support connection – 1 angle bracket (nail pattern B)

Beam to rigid support connection				Modified characteristic capacity per connection (kN)		
Load duration	$R_{1,k}$		$R_{2,k} = R_{3,k}$		$R_{4,k} = R_{5,k}$	
	Connector nail according to ETA-04/0013:					
	4,0x35	4,0x60	4,0x35	4,0x60	4,0x35	4,0x60
P	2,4	4,7	1,3	2,2	$e \leq 0,27 * b + 21$ 4,4	$e \leq 0,44 * b + 25$ 4,4
					$e > 0,27 * b + 21$ $0,74 * (1,63 * b + 109)$ $/(e-1,5)$	$e > 0,44 * b + 25$ $0,87 * (2,67 * b + 136)$ $/(e-1,5)$
L	2,8	5,4	1,6	2,6	$e \leq 0,29 * b + 21$ 4,8	$e \leq 0,48 * b + 25$ 4,8
					$e > 0,29 * b + 21$ $0,74 * (1,90 * b + 116)$ $/(e-1,5)$	$e > 0,48 * b + 25$ $0,87 * (3,12 * b + 147)$ $/(e-1,5)$
M	3,2	5,9	1,8	3,0	$e \leq 0,31 * b + 21$ 5,1	$e \leq 0,51 * b + 26$ 5,1
					$e > 0,31 * b + 21$ $0,74 * (2,17 * b + 123)$ $/(e-1,5)$	$e > 0,51 * b + 26$ $0,87 * (3,57 * b + 158)$ $/(e-1,5)$
S	3,6	5,9	2,1	3,3	$e \leq 0,33 * b + 20$ 5,5	$e \leq 0,54 * b + 26$ 5,5
					$e > 0,33 * b + 20$ $0,74 * (2,45 * b + 130)$ $/(e-1,5)$	$e > 0,54 * b + 26$ $0,87 * (4,01 * b + 169)$ $/(e-1,5)$
I	4,4	5,9	2,5	4,1	$e \leq 0,36 * b + 20$ 6,0	$e \leq 0,60 * b + 26$ 6,0
					$e > 0,36 * b + 20$ $0,74 * (2,99 * b + 143)$ $/(e-1,5)$	$e > 0,60 * b + 26$ $0,87 * (4,90 * b + 191)$ $/(e-1,5)$

E5/1,5	connection with 1 angle brackets			
factor:	for $F_1$	for $F_{2/3}$	for $F_4$	for $F_5$
$k_{ax}$	$(f+38)/8$	0,46	$e/8$	-
$k_{lat}$	-	1,00	1,00	-

For each bolt it's needed to check:  $R_{bolt,d,lateral} \geq k_{lat} \times F_{i,d}$  ;  $R_{bolt,d,axial} \geq k_{ax} \times F_{i,d}$  ; and also the combination

Table D31-7: E5/1.5 - timber to timber connection - 2 angle brackets (nail pattern C)

The capacities given in the table below are valid for E5/1.5, E5/1.5/11.22/11

Beam to beam connection - Characteristic capacity per connection (kN)									
Number of fasteners		$R_{1,k}$				$R_{2,k}$			
Joist	Support	4.0x35	4.0x40	4.0x50	4.0x60	4.0x35	4.0x40	4.0x50	4.0x60
2 x 7 nails	2 x 6 nails	6,1	7,1	8,6	9,3	9,8	10,8	13	14

Table D31-8: E5/1.5 - timber to rigid support connection – 2 angle brackets (nail pattern D)

The capacities given in the table below are valid for E5/1.5, E5/1.5/11.22/11

Beam to rigid support connection - Characteristic capacity per connection (kN)									
Number of fasteners		$R_{1,k}$				$R_{2,k}^*$			
Joist	Support	4.0x35	4.0x40	4.0x50	4.0x60	4.0x35	4.0x40	4.0x50	4.0x60
2 x 7 nails	2 x 1 bolt $\varnothing 10$	6,6	6,6	6,6	6,6	5,8	6,7	8,6	9,9

\*only available for a connection in a round hole, not with the version with oblong hole

When there are two angle brackets, the anchor group must resist to F1 and/or F2

When there is one angle bracket, the anchor must resist to F1 and/or F2

**Annex D32 – E5/2**

**Product Name:**

Product Name	Alternative name			
	UK	France	Denmark	Germany
E5/2	--	--	--	--

**Drawing:**

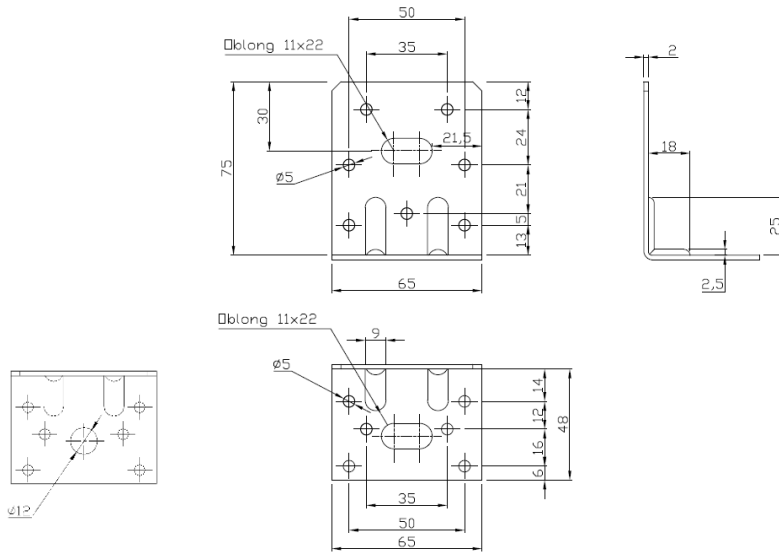

Option: round hole or oblong hole

Figure D32-1: E5/2

**Material:**

Standard material : S250GD + Z275 according to EN 10346  
 Or stainless steel according to clause II-1

**Nail pattern:**

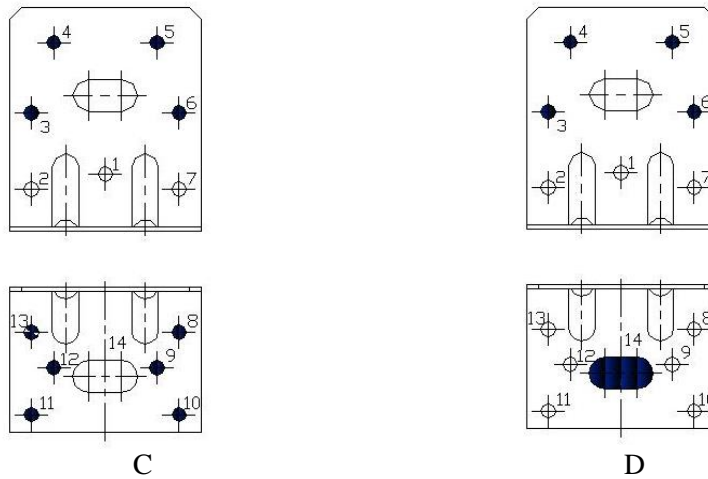

Timber to timber connection

Timber to concrete connection

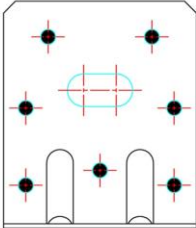
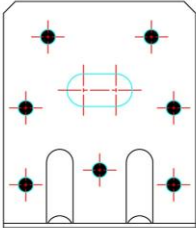

C  
timber to timber

D  
timber to rigid support

Figure D32-2: E5/2 nails pattern

**Modified characteristic capacities:**

Table D32-1 E5/2 - timber to timber connection – 1 angle bracket (nail pattern A)

Beam to beam connection				Characteristic capacity per connection (kN)				
Load duration	R <sub>1,k</sub>		R <sub>2,k</sub> = R <sub>3,k</sub>		R <sub>4,k</sub>		R <sub>5,k</sub>	
	Connector nail according to ETA-04/0013:							
	4,0x35	4,0x60	4,0x35	4,0x60	4,0x35	4,0x60	4,0x35	4,0x60
<b>P</b>	$f \leq 14$ $29 / (f + 46,5)$	$f \leq 7$ $57 / (f + 46,5)$	1,4	2,4	Min of $27,7/(e - 2)$ $23/\sqrt{(e^2 + 25)}$	Min of $27,7/(e - 2)$ $41/\sqrt{(e^2 + 6,2^2)}$	Min of: $1,2*(b + 5)/e$ 1,2	Min of: $2,4*(b + 5)/e$ 2,4
	$f > 14$ $7,1 / (f + 1)$	$f > 7$ $7,1 / (f + 1)$			4,4 $13,1/(e - 27)$	4,4 $13,1/(e - 27)$	For e < 65 $19,2 / (65 - e)$ For e < 41 $7 / (41 - e)$	For e < 65 $38,4 / (65 - e)$ For e < 41 $7 / (41 - e)$ 65 / e
<b>L</b>	$f \leq 11$ $33 / (f + 46,5)$	$f \leq 6$ $67 / (f + 46,5)$	1,6	2,9	Min of $27,7/(e - 2)$ $28/\sqrt{(e^2 + 25)}$	Min of $27,7/(e - 2)$ $48/\sqrt{(e^2 + 6,2^2)}$	Min of $1,4*(b + 5)/e$ 1,55	Min of $2,8*(b + 5)/e$ 2,35
	$f > 11$ $7,1 / (f + 1)$	$f > 6$ $7,1 / (f + 1)$			4,8 $13,1/(e - 27)$	4,8 $13,1/(e - 27)$	For e < 65 $22,4 / (65 - e)$ For e < 41 $7 / (41 - e)$	For e < 65 $44,8 / (65 - e)$ For e < 41 $7 / (41 - e)$ 65 / e
<b>M</b>	$f \leq 10$ $38 / (f + 46,5)$	$f \leq 5$ $76 / (f + 46,5)$	1,8	3,3	Min of $27,7/(e - 2)$ $32/\sqrt{(e^2 + 25)}$	Min of $27,7/(e - 2)$ $55/\sqrt{(e^2 + 6,2^2)}$	Min of $1,6*(b + 5)/e$ 1,6	Min of $3,2*(b + 5)/e$ 2,5
	$f > 10$ $7,1 / (f + 1)$	$f > 5$ $7,1 / (f + 1)$			5,2 $13,1/(e - 27)$	5,2 $13,1/(e - 27)$	For e < 65 $25,6 / (65 - e)$ For e < 41 $7 / (41 - e)$	For e < 41 min of : $7 / (41 - e)$ 65 / e
<b>S</b>	$f \leq 8$ $43 / (f + 46,5)$	$f \leq 4$ $86 / (f + 46,5)$	2,1	3,7	Min of $27,7/(e - 2)$ $36/\sqrt{(e^2 + 25)}$	Min of $27,7/(e - 2)$ $61/\sqrt{(e^2 + 6,2^2)}$	Min of $2,42*(b + 5)/e$ 1,7	Min of $3,6*(b + 5)/e$ 2,7
	$f > 8$ $7,1 / (f + 1)$	$f > 4$ $7,1 / (f + 1)$			5,5 $13,1/(e - 27)$	5,5 $13,1/(e - 27)$	For e < 65 $28,8 / (65 - e)$ For e < 41 $7 / (41 - e)$	For e < 41 min of: $7 / (41 - e)$ 65 / e
<b>I</b>	$f \leq 6$ $52 / (f + 46,5)$	$f \leq 3$ $105 / (f + 46,5)$	2,6	4,5	Min of $27,7/(e - 2)$ $44/\sqrt{(e^2 + 25)}$	Min of $27,7/(e - 2)$ $74/\sqrt{(e^2 + 6,2^2)}$	Min of $2,95*(b + 5)/e$ 1,9	Min of $4,2*(b + 5)/e$ 2,9
	$f > 6$ $7,1 / (f + 1)$	$f > 3$ $7,1 / (f + 1)$			6 $13,1/(e - 27)$	6 $13,1/(e - 27)$	For e < 65 $35,2 / (65 - e)$ For e < 41 $7 / (41 - e)$	For e < 41 min of: $7 / (41 - e)$ 65 / e

**Note:** For R<sub>1,k</sub>, if the purlin is prevented from rotation, consider the value as the half of the one given for two brackets.  
For R<sub>4,k</sub> if the purlin is prevented from rotation, consider the value given for two brackets for e=0



Table D32-2 E5/2 - timber to timber connection – 2 angle brackets (nail pattern A)

Beam to beam connection				Modified characteristic capacity per connection (kN)		
Load duration	R <sub>1,k</sub>		R <sub>2,k</sub> = R <sub>3,k</sub>		R <sub>4,k</sub> = R <sub>5,k</sub>	
	4,0x35	4,0x60	4,0x35	4,0x60	4,0x35	4,0x60
P	2,5	5	2,8	4,9	$e \leq 0,26 * b + 18$ 4,8	$e \leq 0,43 * b + 20$ 4,8
					$e > 0,26 * b + 18$ $0,74*(1,70*b+100)$ $/(e-2)$	$e > 0,43 * b + 20$ $0,87*(2,89*b+118)$ $/(e-2)$
L	3,0	5,8	3,2	5,8	$e \leq 0,27 * b + 17$ 5,4	$e \leq 0,46 * b + 19$ 5,4
					$e > 0,27 * b + 17$ $0,74*(1,98*b+105)$ $/(e-2)$	$e > 0,46 * b + 19$ $0,87*(3,37*b+125)$ $/(e-2)$
M	3,3	6,7	3,7	6,5	$e \leq 0,29 * b + 17$ 5,7	$e \leq 0,50 * b + 19$ 5,7
					$e > 0,29 * b + 17$ $0,74*(2,26*b+109)$ $/(e-2)$	$e > 0,50 * b + 19$ $0,87*(3,85*b+133)$ $/(e-2)$
S	3,7	7,5	4,2	7,4	$e \leq 0,31 * b + 17$ 7,1	$e \leq 0,53 * b + 19$ 7,1
					$e > 0,31 * b + 17$ $0,74*(2,54*b+113)$ $/(e-2)$	$e > 0,53 * b + 19$ $0,87*(4,33*b+140)$ $/(e-2)$
I	4,6	8,8	5,2	9,1	$e \leq 0,34 * b + 16$ 6,7	$e \leq 0,56 * b + 19$ 6,7
					$e > 0,34 * b + 16$ $0,74*(3,11*b+122)$ $/(e-2)$	$e > 0,56 * b + 19$ $0,87*(5,07*b+151)$ $/(e-2)$

Table D32-3 E5/2 - timber to rigid support connection – 1 angle bracket (nail pattern B)

Beam to rigid support connection			Modified characteristic capacity per connection (kN)					
Load duration	R <sub>1,k</sub>		R <sub>2,k</sub> = R <sub>3,k</sub>		R <sub>4,k</sub>		R <sub>5,k</sub>	
	Connector nail according to ETA-04/0013: 4,0x35   4,0x60		4,0x35	4,0x60	4,0x35	4,0x60	4,0x35	4,0x60
<b>P</b>	Min of 13,8 / ( f +24 ) 7,2 / f		0,6	1,1	Min of 55,4 / e 14,2 / ( e - 26 ) 12,9		/	/
<b>L</b>			0,8	1,3			/	/
<b>M</b>			0,9	1,5			/	/
<b>S</b>			1,1	1,7			/	/
<b>I</b>			1,2	2,1			/	/

Note: For R<sub>1,k</sub>, if the purlin is prevented from rotation, consider the value as the half of the one given for two brackets.  
For R<sub>4,k</sub> if the purlin is prevented from rotation, consider the value given for two brackets for e=0.

E5/2	connection with 1 angle brackets			
factor:	for F <sub>1</sub>	for F <sub>2/3</sub>	for F <sub>4</sub>	for F <sub>5</sub>
<b>k<sub>ax</sub></b>	(f+38)/8	0,09	e/8	-
<b>k<sub>lat</sub></b>	-	1,00	1,00	-

For each bolt it's needed to check:  $R_{\text{bolt,d,lateral}} \geq k_{\text{lat}} \times F_{i,d}$  ;  $R_{\text{bolt,d,axial}} \geq k_{\text{ax}} \times F_{i,d}$  ; and also the combination

Table D32-4 E5/2 - timber to rigid support connection – 2 angle brackets (nail pattern B)

Beam to rigid support connection				Modified characteristic capacity per connection (kN)			
Load duration	R <sub>1,k</sub>		R <sub>2,k</sub> = R <sub>3,k</sub>		R <sub>4,k</sub> = R <sub>5,k</sub>		
	Connector nail according to ETA-04/0013:						
	4,0x35	4,0x60	4,0x35	4,0x60	4,0x35	4,0x60	
P	2,4	4,5	1,3	2,2	e ≤ 0,22 * b + 23 5,3	e ≤ 0,35 * b + 26 5,3	
					e > 0,22 * b + 23 0,74*(1,59*b+145) /(e-2)	e > 0,35 * b + 26 0,87*(2,61*b+170) /(e-2)	
L	2,7	5,3	1,5	2,7	e ≤ 0,23 * b + 22 6,0	e ≤ 0,38 * b + 25 6,0	
					e > 0,23 * b + 22 0,74*(1,85*b+151) /(e-2)	e > 0,38 * b + 25 0,87*(3,05*b+181) /(e-2)	
M	3,1	6,1	1,7	3,1	e ≤ 0,25 * b + 21 6,4	e ≤ 0,40 * b + 25 6,4	
					e > 0,25 * b + 21 0,74*(2,12*b+158) /(e-2)	e > 0,40 * b + 25 0,87*(3,48*b+192) /(e-2)	
S	3,5	6,8	2,0	3,4	e ≤ 0,26 * b + 21 6,8	e ≤ 0,43 * b + 25 6,8	
					e > 0,26 * b + 21 0,74*(2,38*b+164) /(e-2)	e > 0,43 * b + 25 0,87*(3,92*b+203) /(e-2)	
I	4,3	8,3	2,5	4,1	e ≤ 0,29 * b + 21 7,5	e ≤ 0,47 * b + 25 7,5	
					e > 0,29 * b + 21 0,74*(2,91*b+178) /(e-2)	e > 0,47 * b + 25 0,87*(4,79*b+225) /(e-2)	

E5/2	connection with 2 angle brackets			
factor:	for F <sub>1</sub>	for F <sub>2/3</sub>	for F <sub>4/5</sub> , bolt 1	for F <sub>4/5</sub> , bolt 2
k <sub>ax</sub>	1,00	0,05	1,99 x e/(b+25)	-
k <sub>lat</sub>	-	0,50	-	1,00

For each bolt it's needed to check:  $R_{\text{bolt,d,lateral}} \geq k_{\text{lat}} \times F_{i,d}$  ;  $R_{\text{bolt,d,axial}} \geq k_{\text{ax}} \times F_{i,d}$  ; and also the combination

Table D32-5: E5/2 - timber to timber connection - 2 angle brackets (nail pattern C)

Beam to beam connection - Characteristic capacity per connection (kN)									
Number of fasteners		$R_{1,k}$				$R_{2,k}$			
Joist	Support	4.0x35	4.0x40	4.0x50	4.0x60	4.0x35	4.0x40	4.0x50	4.0x60
2 x 7 nails	2 x 6 nails	6,1	7,1	8,6	9,8	9,8	10,7	13,0	13,8

Table D32-6: E5/2 - timber to rigid support connection – 2 angle brackets (nail pattern D)

Beam to rigid support connection - Characteristic capacity per connection (kN)									
Number of fasteners		$R_{1,k}$				$R_{2,k}^*$			
Joist	Support	4.0x35	4.0x40	4.0x50	4.0x60	4.0x35	4.0x40	4.0x50	4.0x60
2 x 7 nails	2 x 1 bolt $\varnothing$ 10	8,4	8,4	8,4	8,4	6,0	6,9	8,8	10,1

\*only available for a connection in a round hole, not with the version with oblong hole

When there is two angle brackets, the anchor group must resist to F1 and/or F2

When there is one angle bracket, the anchor must resist to F1 and/or F2

**Annex D33 – AT1**

**Product Name:**

Product Name	Alternative name			
	UK	France	Denmark	Germany
AT1	--	--	--	--

**Drawing:**

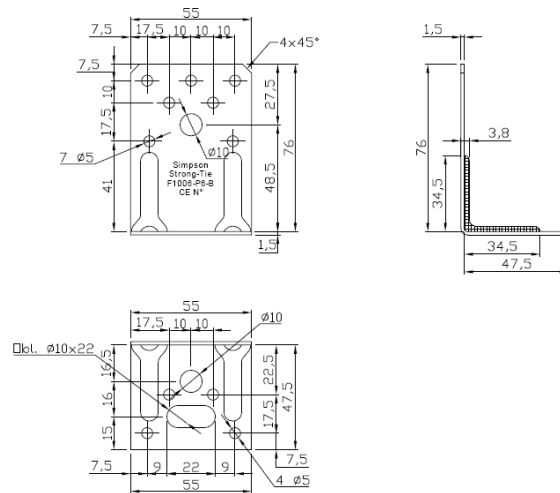
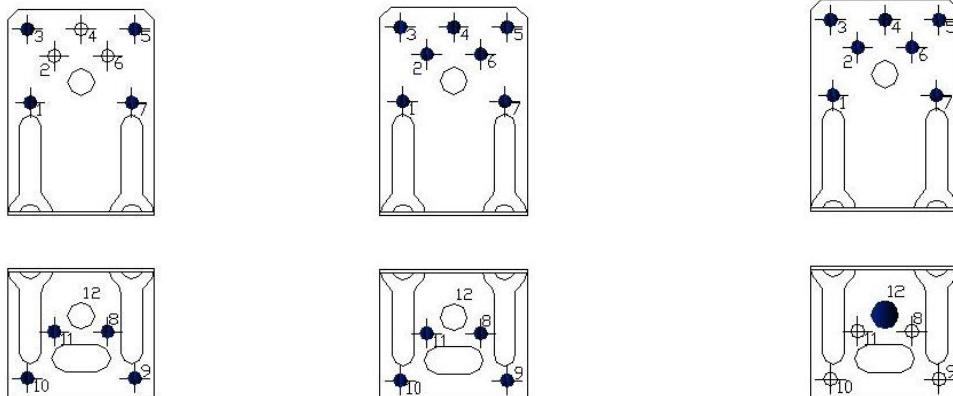

Figure D33-1: AT1

**Material:**

Standard material : S250GD + Z275 according to EN 10346  
 Or stainless steel according to clause II-1

**Nail pattern:**



Timber to timber connection  
 Partial Nailing

Full nailing  
 Figure D33-2: AT1 nails pattern

Timber to rigid connection

**Characteristic capacities**

Table D34-1 AT1 - timber to timber connection – 1 angle bracket – partial nailing

Beam to beam connection				Characteristic capacity per connection (kN)				k <sub>modi</sub> =1,18	
Load duration	R <sub>1,k</sub>		R <sub>2,k</sub> = R <sub>3,k</sub>		R <sub>4,k</sub>		R <sub>5,k</sub>		
	Connector nail according to ETA-04/0013:								
	4,0x35	4,0x60	4,0x35	4,0x60	4,0x35	4,0x60	4,0x35	4,0x60	
<b>P</b>	f ≤ 15 15 / (f + 43,5)	f ≤ 7 32 / (f + 43,5)	1,2	2,1	Min of 17,7/(e - 1,5) 15/√(e <sup>2</sup> + 4,9 <sup>2</sup> )	Min of 17,7/(e - 1,5) 27/√(e <sup>2</sup> + 6,1 <sup>2</sup> )	Min of: 0,7*(b + 13)/e 1	Min of: 1,4*(b + 13)/e 1,5	
	f > 15 4,3 / (f + 1)	f > 7 4,3 / (f + 1)			3,5 5,5 / (e - 36)	3,5 5,5 / (e - 36)	For e < 42,5 21,7 / (70 - e) 40 / e 5,5 / (43 - e)	For e < 42,5 43,6 / (70 - e) 40 / e 5,5 / (43 - e)	
<b>L</b>	f ≤ 12 18 / (f + 43,5)	f ≤ 6 37 / (f + 43,5)	1,3	2,3	Min of 17,7/(e - 1,5) 18/√(e <sup>2</sup> + 4,9 <sup>2</sup> )	Min of 17,7/(e - 1,5) 32/√(e <sup>2</sup> + 6,1 <sup>2</sup> )	Min of 0,8*(b + 13)/e 1,1	Min of: 1,63*(b + 13)/e 1,7	
	f > 12 4,3 / (f + 1)	f > 6 4,3 / (f + 1)			3,8 5,5 / (e - 36)	3,8 5,5 / (e - 36)	For e < 42,5 25,4 / (70 - e) 40 / e 5,5 / (43 - e)	For e < 42,5 51 / (70 - e) 40 / e 5,5 / (43 - e)	
<b>M</b>	f ≤ 10 21 / (f + 43,5)	f ≤ 5 42 / (f + 43,5)	1,5	2,7	Min of 17,7/(e - 1,5) 21/√(e <sup>2</sup> + 4,9 <sup>2</sup> )	Min of 17,7/(e - 1,5) 36/√(e <sup>2</sup> + 6,1 <sup>2</sup> )	Min of 0,93*(b + 13)/e 1,2	Min of 1,9*(b + 13)/e 1,7	
	f > 10 4,3 / (f + 1)	f > 5 4,3 / (f + 1)			4,1 5,5 / (e - 36)	4,1 5,5 / (e - 36)	For e < 42,5 29 / (70 - e) 40 / e 5,5 / (43 - e)	For e < 42,5 40 / e 5,5 / (43 - e)	
<b>S</b>	f ≤ 9 23 / (f + 43,5)	f ≤ 4 48 / (f + 43,5)	1,8	3,1	Min of 17,7/(e - 1,5) 23/√(e <sup>2</sup> + 4,9 <sup>2</sup> )	Min of 17,7/(e - 1,5) 41/√(e <sup>2</sup> + 6,1 <sup>2</sup> )	Min of 1,05*(b + 13)/e 1,3	Min of 2,1*(b + 13)/e 1,8	
	f > 9 4,3 / (f + 1)	f > 4 4,3 / (f + 1)			4,3 5,5 / (e - 36)	4,3 5,5 / (e - 36)	For e < 42,5 32,6 / (70 - e) 40 / e 5,5 / (43 - e)	For e < 42,5 40 / e 5,5 / (43 - e)	
<b>I</b>	f ≤ 7 29 / (f + 43,5)	f ≤ 3 58 / (f + 43,5)	2,1	3,7	Min of 17,7/(e - 1,5) 29/√(e <sup>2</sup> + 4,9 <sup>2</sup> )	Min of 17,7/(e - 1,5) 50/√(e <sup>2</sup> + 6,1 <sup>2</sup> )	Min of 1,28*(b + 13)/e 1,4	Min of 2,4*(b + 13)/e 1,9	
	f > 7 4,3 / (f + 1)	f > 3 4,3 / (f + 1)			4,7 5,5 / (e - 36)	4,7 5,5 / (e - 36)	For e < 42,5 40 / (70 - e) 40 / e 5,5 / (43 - e)	For e < 42,5 40 / e 5,5 / (43 - e)	

**Note:** For R<sub>1,k</sub>, if the purlin is prevented from rotation, consider the value as the half of the one given for two brackets.  
For R<sub>4,k</sub> if the purlin is prevented from rotation, consider the value given for two brackets for e=0.

Table D33-2 AT1 - timber to timber connection – 1 angle bracket – full nailing

Beam to beam connection				Modified characteristic capacity per connection (kN)				
Load duration	R <sub>1,k</sub>		R <sub>2,k</sub> = R <sub>3,k</sub>		R <sub>4,k</sub>		R <sub>5,k</sub>	
	Connector nail according to ETA-04/0013:							
	4,0x35	4,0x60	4,0x35	4,0x60	4,0x35	4,0x60	4,0x35	4,0x60
<b>P</b>	f ≤ 15 15 / (f + 43,5)	f ≤ 7 32 / (f + 43,5)	1,2	2,2	Min of 17,7/(e - 1,5) 15/√(e <sup>2</sup> + 4,9 <sup>2</sup> )	Min of 17,7/(e - 1,5) 27/√(e <sup>2</sup> + 6,1 <sup>2</sup> )	Min of: 0,7*(b + 13)/e 1	Min of: 1,4*(b + 13)/e 1,5
	f > 15 4,3 / (f + 1)	f > 7 4,3 / (f + 1)			3,5 5,5 / (e - 36)	3,5 5,5 / (e - 36)	For e < 42,5 21,7 / (70 - e) 40 / e 5,5 / (43 - e)	For e < 42,5 40 / e 5,5 / (43 - e)
<b>L</b>	f ≤ 12 18 / (f + 43,5)	f ≤ 6 37 / (f + 43,5)	1,4	2,5	Min of 17,7/(e - 1,5) 18/√(e <sup>2</sup> + 4,9 <sup>2</sup> )	Min of 17,7/(e - 1,5) 32/√(e <sup>2</sup> + 6,1 <sup>2</sup> )	Min of 0,8*(b + 13)/e 1,1	Min of: 1,63*(b + 13)/e 1,7
	f > 12 4,3 / (f + 1)	f > 6 4,3 / (f + 1)			3,8 5,5 / (e - 36)	3,8 5,5 / (e - 36)	For e < 42,5 25,4 / (70 - e) 40 / e 5,5 / (43 - e)	For e < 42,5 40 / e 5,5 / (43 - e)
<b>M</b>	f ≤ 10 21 / (f + 43,5)	f ≤ 5 42 / (f + 43,5)	1,6	2,8	Min of 17,7/(e - 1,5) 21/√(e <sup>2</sup> + 4,9 <sup>2</sup> )	Min of 17,7/(e - 1,5) 36/√(e <sup>2</sup> + 6,1 <sup>2</sup> )	Min of 0,93*(b + 13)/e 1,2	Min of 1,9*(b + 13)/e 1,7
	f > 10 4,3 / (f + 1)	f > 5 4,3 / (f + 1)			4,1 5,5 / (e - 36)	4,1 5,5 / (e - 36)	For e < 42,5 29 / (70 - e) 40 / e 5,5 / (43 - e)	For e < 42,5 40 / e 5,5 / (43 - e)
<b>S</b>	f ≤ 9 23 / (f + 43,5)	f ≤ 4 48 / (f + 43,5)	1,8	3,1	Min of 17,7/(e - 1,5) 23/√(e <sup>2</sup> + 4,9 <sup>2</sup> )	Min of 17,7/(e - 1,5) 41/√(e <sup>2</sup> + 6,1 <sup>2</sup> )	Min of 1,05*(b + 13)/e 1,3	Min of 2,1*(b + 13)/e 1,8
	f > 9 4,3 / (f + 1)	f > 4 4,3 / (f + 1)			4,3 5,5 / (e - 36)	4,3 5,5 / (e - 36)	For e < 42,5 40 / e 5,5 / (43 - e)	For e < 42,5 40 / e 5,5 / (43 - e)
<b>I</b>	f ≤ 7 29 / (f + 43,5)	f ≤ 3 58 / (f + 43,5)	2,2	3,9	Min of 17,7/(e - 1,5) 29/√(e <sup>2</sup> + 4,9 <sup>2</sup> )	Min of 17,7/(e - 1,5) 50/√(e <sup>2</sup> + 6,1 <sup>2</sup> )	Min of 1,28*(b + 13)/e 1,4	Min of 2,4*(b + 13)/e 1,9
	f > 7 4,3 / (f + 1)	f > 3 4,3 / (f + 1)			4,7 5,5 / (e - 36)	4,7 5,5 / (e - 36)	For e < 42,5 40 / e 5,5 / (43 - e)	For e < 42,5 40 / e 5,5 / (43 - e)

**Note:** For R<sub>1,k</sub>, if the purlin is prevented from rotation, consider the value as the half of the one given for two brackets.  
For R<sub>4,k</sub> if the purlin is prevented from rotation, consider the value given for two brackets for e=0.

Table D33-3 AT1 - timber to timber connection – 2 angle ackets

Beam to beam connection				Modified characteristic capacity per connection (kN)				
Nailing	Load duration	R <sub>1,k</sub>		R <sub>2,k</sub> = R <sub>3,k</sub>		R <sub>4,k</sub> = R <sub>5,k</sub>		
		Connector nail according to ETA-04/0013:						
		4,0x35	4,0x60	4,0x35	4,0x60	4,0x35	4,0x60	
Partial nailing Nail in holes 1,3,5,7/ 8,9,10,11	P	1,5	2,9	2,3	4,0	$e \leq 0,23 * b + 21$ 3,2	$e \leq 0,34 * b + 21$ 3,7	
						$e > 0,23 * b + 21$ $0,74*(1,00*b+77)$ $/(e-1,5)$	$e > 0,34 * b + 21$ $0,87*(1,70*b+93)$ $/(e-1,5)$	
	L	1,7	3,5	2,7	4,8	$e \leq 0,23 * b + 19$ 3,7	$e \leq 0,36 * b + 21$ 4	
						$e > 0,23 * b + 19$ $0,74*(1,16*b+81)$ $/(e-1,5)$	$e > 0,36 * b + 21$ $0,87*(1,98*b+100)$ $/(e-1,5)$	
	M	2,0	3,9	3,1	5,4	$e \leq 0,23 * b + 18$ 4,3	$e \leq 0,39 * b + 21$ 4,3	
						$e > 0,23 * b + 18$ $0,74*(1,33*b+85)$ $/(e-1,5)$	$e > 0,39 * b + 21$ $0,87*(2,27*b+106)$ $/(e-1,5)$	
	S	2,2	4,4	3,5	6,1	$e \leq 0,24 * b + 17$ 4,6	$e \leq 0,41 * b + 21$ 4,6	
						$e > 0,24 * b + 17$ $0,74*(1,50*b+88)$ $/(e-1,5)$	$e > 0,41 * b + 21$ $0,87*(2,55*b+113)$ $/(e-1,5)$	
	I	2,7	5,0	4,3	7,5	$e \leq 0,27 * b + 17$ 5	$e \leq 0,43 * b + 21$ 5	
						$e > 0,27 * b + 17$ $0,74*(1,83*b+96)$ $/(e-1,5)$	$e > 0,43 * b + 21$ $0,87*(2,92*b+121)$ $/(e-1,5)$	
	Full nailing Nail in holes 1,2,3,4,5,6,7 / 8,9,10,11	P	1,5	2,9	2,4	4,2	$e \leq 0,23 * b + 21$ 3,2	$e \leq 0,34 * b + 21$ 3,7
							$e > 0,23 * b + 21$ $0,74*(1,00*b+77)$ $/(e-1,5)$	$e \geq 0,34 * b + 21$ $0,87*(1,70*b+93)$ $/(e-1,5)$
L		1,7	3,5	2,8	4,9	$e \leq 0,23 * b + 19$ 3,7	$e \leq 0,36 * b + 21$ 4	
						$e \geq 0,23 * b + 19$ $0,74*(1,16*b+81)$ $/(e-1,5)$	$e \geq 0,36 * b + 21$ $0,87*(1,98*b+100)$ $/(e-1,5)$	
M		2,0	3,9	3,2	5,7	$e \leq 0,23 * b + 18$ 4,3	$e \leq 0,39 * b + 21$ 4,3	
						$e \geq 0,23 * b + 18$ $0,74*(1,33*b+85)$ $/(e-1,5)$	$e \geq 0,39 * b + 21$ $0,87*(2,27*b+106)$ $/(e-1,5)$	
S		2,2	4,4	3,6	6,4	$e \leq 0,24 * b + 17$ 4,6	$e \leq 0,41 * b + 21$ 4,6	
						$e > 0,24 * b + 17$ $0,74*(1,50*b+88)$ $/(e-1,5)$	$e > 0,41 * b + 21$ $0,87*(2,55*b+113)$ $/(e-1,5)$	
I		2,7	5,0	4,4	7,9	$e \leq 0,27 * b + 17$ 5	$e \leq 0,43 * b + 21$ 5	
						$e > 0,27 * b + 17$ $0,74*(1,83*b+96)$ $/(e-1,5)$	$e > 0,43 * b + 21$ $0,87*(2,92*b+121)$ $/(e-1,5)$	



Table D33-4 AT1 - timber to rigid support connection – 1 angle bracket

Beam to rigid support connection			Modified characteristic capacity per connection (kN)					
Load duration	R <sub>1,k</sub>		R <sub>2,k</sub> = R <sub>3,k</sub>		R <sub>4,k</sub>		R <sub>5,k</sub>	
	4,0x35	4,0x60	4,0x35	4,0x60	4,0x35	4,0x60	4,0x35	4,0x60
P	Min of 28 / ( f + 13 ) 4,3 / f		1,0	1,9	Min of 40 / e 5,5 / ( e - 35 ) 6,4		/	/
L			1,2	2,2			/	/
M			1,3	2,5			/	/
S			1,5	2,9			/	/
I			1,8	3,5			/	/

Note: For R<sub>1,k</sub>, if the purlin is prevented from rotation, consider the value as the half of the one given for two brackets.  
For R<sub>4,k</sub> if the purlin is prevented from rotation, consider the value given for two brackets for e=0.

AT1	connection with 1 angle brackets			
factor:	for F <sub>1</sub>	for F <sub>2/3</sub>	for F <sub>4</sub>	for F <sub>5</sub>
k <sub>ax</sub>	(f+23)/6	1,31	e/6	-
k <sub>lat</sub>	-	1,00	1,00	-

For each bolt it's needed to check:  $R_{\text{bolt,d,lateral}} \geq k_{\text{lat}} \times F_{i,d}$  ;  $R_{\text{bolt,d,axial}} \geq k_{\text{ax}} \times F_{i,d}$  ; and also the combination

Table D33-5 AT1 - timber to rigid support connection – 2 angle brackets

Beam to rigid support connection				Modified characteristic capacity per connection (kN)			
Load duration	R <sub>1,k</sub>		R <sub>2,k</sub> = R <sub>3,k</sub>		R <sub>4,k</sub> = R <sub>5,k</sub>		
	Connector nail according to ETA-04/0013:						
	4,0x35	4,0x60	4,0x35	4,0x60	4,0x35	4,0x60	
P	Min of 5,8	Min of 10,9	2,1	3,8	e ≤ 0,68 * b + 28 4,3	e ≤ 1,08 * b + 34 4,3	
	0,75 * R <sub>k,anchor</sub>	0,75 * R <sub>k,anchor</sub>			e > 0,68 * b + 28 0,74*(3,93*b+142) /(e-1,5)	e > 1,08 * b + 34 0,87*(6,24*b+182) /(e-1,5)	
L	Min of 6,8	Min of 12,7	2,4	4,4	e ≤ 0,73 * b + 28 4,6	e ≤ 1,16 * b + 35 4,6	
	0,75 * R <sub>k,anchor</sub>	0,75 * R <sub>k,anchor</sub>			e > 0,73 * b + 28 0,74*(4,58*b+154) /(e-1,5)	e > 1,16 * b + 35 0,87*(7,28*b+199) /(e-1,5)	
M	Min of 7,8	Min of 14,4	2,7	5,0	e ≤ 0,78 * b + 28 4,9	e ≤ 1,24 * b + 35 4,9	
	0,75 * R <sub>k,anchor</sub>	0,75 * R <sub>k,anchor</sub>			e > 0,78 * b + 28 0,74*(5,23*b+165) /(e-1,5)	e > 1,24 * b + 35 0,87*(8,32*b+217) /(e-1,5)	
S	Min of 8,7	Min of 16,1	3,1	5,7	e ≤ 0,83 * b + 28 5,2	e ≤ 1,32 * b + 36 5,2	
	0,75 * R <sub>k,anchor</sub>	0,75 * R <sub>k,anchor</sub>			e > 0,83 * b + 28 0,74*(5,89*b+176) /(e-1,5)	e > 1,32 * b + 36 0,87*(9,36*b+235) /(e-1,5)	
I	Min of 10,6	Min of 16,1	3,8	7,0	e ≤ 0,92 * b + 28 5,8	e ≤ 1,46 * b + 37 5,8	
	0,75 * R <sub>k,anchor</sub>	0,75 * R <sub>k,anchor</sub>			e > 0,92 * b + 28 0,74*(7,20*b+198) /(e-1,5)	e > 1,46 * b + 37 0,87*(11,44*b+270) /(e-1,5)	

AT1	connection with 2 angle brackets			
factor:	for F <sub>1</sub>	for F <sub>2/3</sub>	for F <sub>4/5</sub> , bolt 1	for F <sub>4/5</sub> , bolt 2
k <sub>ax</sub>	1,17	0,65	2,35 x e/(b+17)	-
k <sub>lat</sub>	-	0,50	-	1,00

For each bolt it's needed to check:  $R_{bolt,d,lateral} \geq k_{lat} \times F_{i,d}$  ;  $R_{bolt,d,axial} \geq k_{ax} \times F_{i,d}$  ; and also the combination

**Annex D34 – E4/2.5**

**Product Name:**

Product Name	Alternative name			
	UK	France	Denmark	Germany
E4/2.5	--	--	--	--

**Drawing:**

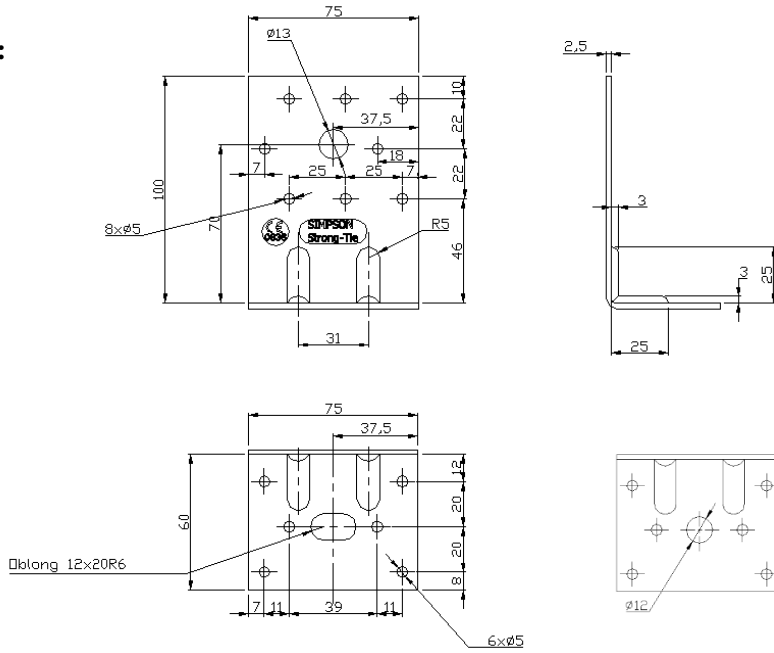

Option: round hole or oblong hole

Figure D34-1: E4/2.5

**Material:**

Standard material : S250GD + Z275 according to EN 10346  
 Or stainless steel according to clause II-1

**Nail pattern:**

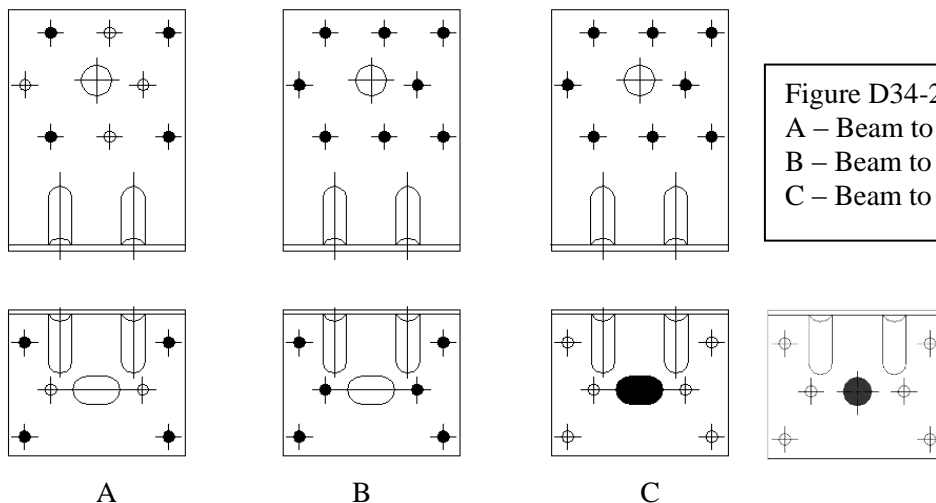

Figure D34-2 : E4/2.5 nails pattern  
 A – Beam to beam connection – Partial nailing  
 B – Beam to beam connection – Full nailing  
 C – Beam to rigid support connection

**Modified characteristic capacities:**

Table D34-1 E4/2.5 - timber to timber connection – 1 angle bracket

Beam to beam connection				Modified characteristic capacity per connection (kN)				
Load duration	Partial nailing: 4+4 (fig. D34-2 A)				Full nailing 8+6 (fig. D34-2 B)			
	R <sub>1,k</sub>		R <sub>2,k</sub> = R <sub>3,k</sub>		R <sub>1,k</sub>		R <sub>2,k</sub> = R <sub>3,k</sub>	
	Connector nail according to ETA-04/0013:				Connector nail according to ETA-04/0013:			
	4,0x35	4,0x60	4,0x35	4,0x60	4,0x35	4,0x60	4,0x35	4,0x60
P	f ≤ 92,4 32 / (f + 56,6)	f ≤ 31,1 65 / (f + 56,6)	1,2	2,1	f ≤ 65,9 37 / (f + 56,5)	f ≤ 25 75 / (f + 56,5)	1,3	2,6
	f > 92,4 20,5 / (f + 1)	f > 31,1 20,5 / (f + 1)			f > 65,9 20,5 / (f + 1)	f > 25 20,5 / (f + 1)		
L	f ≤ 63,4 37 / (f + 56,6)	f ≤ 24,4 75 / (f + 56,6)	1,5	2,5	f ≤ 47,8 43 / (f + 56,5)	f ≤ 19,8 87 / (f + 56,5)	1,5	3
	f > 63,4 20,5 / (f + 1)	f > 24,4 20,5 / (f + 1)			f > 47,8 20,5 / (f + 1)	f > 19,8 20,5 / (f + 1)		
M	f ≤ 48,1 43 / (f + 56,6)	f ≤ 19,9 87 / (f + 56,6)	1,7	3	f ≤ 37,4 50 / (f + 56,5)	f ≤ 16,3 99 / (f + 56,5)	1,7	3,5
	f > 48,1 20,5 / (f + 1)	f > 19,9 20,5 / (f + 1)			f > 37,4 20,5 / (f + 1)	f > 16,3 20,5 / (f + 1)		
S	f ≤ 38,7 49 / (f + 56,6)	f ≤ 16,8 97 / (f + 56,6)	1,9	3,3	f ≤ 30,6 56 / (f + 56,5)	f ≤ 13,9 112 / (f + 56,5)	2,1	4
	f > 38,7 20,5 / (f + 1)	f > 16,8 20,5 / (f + 1)			f > 30,6 20,5 / (f + 1)	f > 13,9 20,5 / (f + 1)		
I	f ≤ 27,6 60 / (f + 56,6)	f ≤ 12,7 120 / (f + 56,6)	2,3	4,0	f ≤ 22,3 68 / (f + 56,5)	f ≤ 10,5 136 / (f + 56,5)	2,5	4,8
	f > 27,6 20,5 / (f + 1)	f > 12,7 20,5 / (f + 1)			f > 22,3 20,5 / (f + 1)	f > 10,5 20,5 / (f + 1)		

Note: For R<sub>1,k</sub>, if the purlin is prevented from rotation, consider the value as the half of the one given for two brackets.

Table D34-2 E4/2.5 - timber to timber connection – 2 angle brackets

Beam to beam connection - Characteristic capacity per connection (kN)									
Number of fasteners		R <sub>1,k</sub>				R <sub>2,k</sub>			
Joist	Support	4.0x35	4.0x40	4.0x50	4.0x60	4.0x35	4.0x40	4.0x50	4.0x60
2 x 8 nails	6 nails	5,5	6,3	7,2	7,6	7,6	8,3	10,1	10,7

Connector nail according to ETA-04/0013

Table D34-3 E4/2.5 - timber to rigid support connection 1 angle bracket per connection

Load duration	1 angle bracket per connection			
	R <sub>1,k</sub>		R <sub>2,k</sub> = R <sub>3,k</sub>	
	Connector nail according to ETA-04/0013:			
	4,0x35	4,0x60	4,0x35	4,0x60
P			0,6	1,2
L			0,7	1,4
M	min of : 15,4 / (f+28)	min of : 15,4 / (f+28)	0,8	1,7
S	20,5 / f	20,5 / f	0,9	1,9
I			1,1	2,2

Note: For R<sub>1,k</sub> for 1 angle bracket connection, if the purlin or column is prevented from rotation, consider the value as the half of the one given for two brackets.

\*only available for a connection in a round hole, not with the version with oblong hole

E4/2,5	connection with 1 angle brackets	
factor:	for F <sub>1</sub>	for F <sub>2/3</sub>
k <sub>ax</sub>	(f+41,5)/8	1,87
k <sub>lat</sub>	-	1,00

For each bolt it's needed to check:  $R_{\text{bolt},d,\text{lateral}} \geq k_{\text{lat}} \times F_{i,d}$  ;  $R_{\text{bolt},d,\text{axial}} \geq k_{\text{ax}} \times F_{i,d}$  ; and also the combination

Table D34-4 E4/2.5 - timber to rigid support connection 2 angle brackets per connection

Beam to rigid support connection - Characteristic capacity per connection (kN)									
Number of fasteners		R <sub>1,k</sub>				R <sub>2,k</sub> *			
Joist	Support	4.0x35	4.0x40	4.0x50	4.0x60	4.0x35	4.0x40	4.0x50	4.0x60
2 x 8 nails	1 bolt Ø10	12,6	12,6	12,6	12,6	5,7	6,5	8,1	9,0

\*only available for a connection in a round hole, not with the version with oblong hole

<b>E4/2,5</b>	connection with 2 angle brackets	
	factor:	
	for $F_1$	for $F_{2/3}$
<b><math>k_{ax}</math></b>	1,02	0,93
<b><math>k_{lat}</math></b>	-	0,50

For each bolt it's needed to check:  $R_{bolt,d,lateral} \geq k_{lat} \times F_{i,d}$  ;  $R_{bolt,d,axial} \geq k_{ax} \times F_{i,d}$  ; and also the combination

**Annex D35 – E6/2**

**Product Name:**

Product Name	Alternative name			
	UK	France	Denmark	Germany
E6/2	--	--	--	--

**Drawing:**

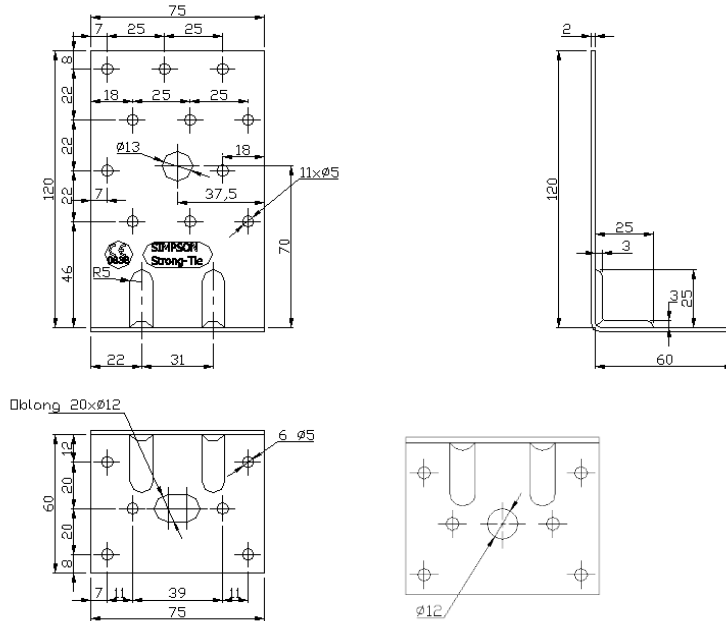

Figure D35-1: E6/2

**Material:**

Standard material : S250GD + Z275 according to EN 10346

Or stainless steel according to clause II-1

**Nail pattern:**

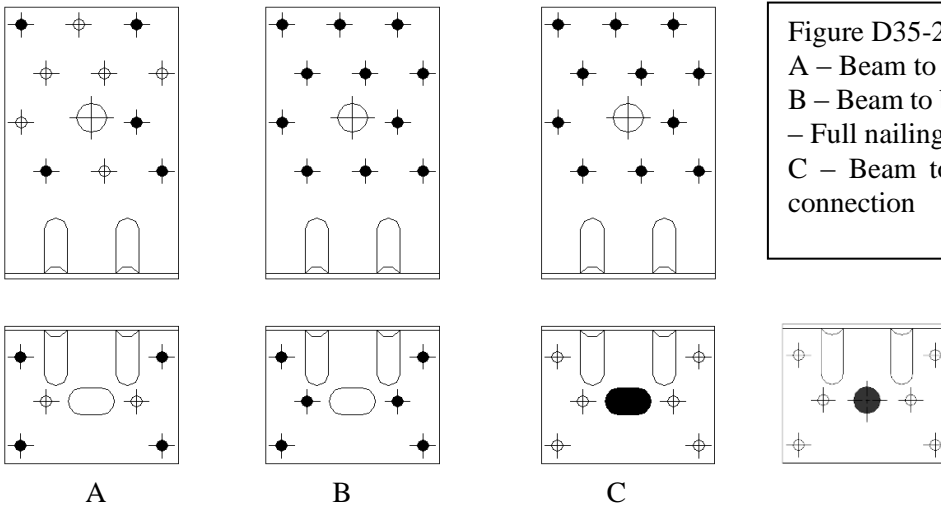

Figure D35-2 : E6/2 nails pattern  
 A – Beam to beam connection – Partial nailing  
 B – Beam to beam and Post to beam connection – Full nailing  
 C – Beam to rigid and Post to rigid support connection

**Modified characteristic capacities:**

Table D35-1 E6/2 - timber to timber connection – 1 angle bracket

Beam to beam connection					Modified characteristic capacity per connection (kN)			
Load duration	Partial nailing 5+4 (fig. D35-2 A)				Full nailing 11+6 (fig. D35-2)			
	R <sub>1,k</sub>		R <sub>2,k</sub> = R <sub>3,k</sub>		R <sub>1,k</sub>		R <sub>2,k</sub> = R <sub>3,k</sub>	
	Connector nail according to ETA-04/0013:				Connector nail according to ETA-04/0013:			
	4,0x35	4,0x60	4,0x35	4,0x60	4,0x35	4,0x60	4,0x35	4,0x60
<b>P</b>	f ≤ 36,2 32 / (f + 56)	f ≤ 16,1 65 / (f + 56)	1,2	2,2	f ≤ 28,7 37 / (f + 56)	f ≤ 13,3 75 / (f + 56)	1,5	2,9
	f > 36,2 13,1 / (f + 1)	f > 16,1 13,1 / (f + 1)			f > 28,7 13,1 / (f + 1)	f > 13,3 13,1 / (f + 1)		
<b>L</b>	f ≤ 28 37 / (f + 56)	f ≤ 13 75 / (f + 56)	1,4	2,6	f ≤ 22,7 44 / (f + 56)	f ≤ 10,8 87 / (f + 56)	1,8	3,4
	f > 28 13,1 / (f + 1)	f > 13 13,1 / (f + 1)			f > 22,7 13,1 / (f + 1)	f > 10,8 13,1 / (f + 1)		
<b>M</b>	f ≤ 22,8 43 / (f + 56)	f ≤ 10,9 87 / (f + 56)	1,6	3	f ≤ 18,7 50 / (f + 56)	f ≤ 9,1 99 / (f + 56)	2,1	3,9
	f > 22,8 13,1 / (f + 1)	f > 10,9 13,1 / (f + 1)			f > 18,7 13,1 / (f + 1)	f > 9,1 13,1 / (f + 1)		
<b>S</b>	f ≤ 19,2 49 / (f + 56)	f ≤ 9,3 97 / (f + 56)	1,7	3,3	f ≤ 15,8 56 / (f + 56)	f ≤ 7,8 112 / (f + 56)	2,4	4,3
	f > 19,2 13,1 / (f + 1)	f > 9,3 13,1 / (f + 1)			f > 15,8 13,1 / (f + 1)	f > 7,8 13,1 / (f + 1)		
<b>I</b>	f ≤ 14,5 59 / (f + 56)	f ≤ 7,2 120 / (f + 56)	2,2	4,1	f ≤ 12 68 / (f + 56)	f ≤ 6 136 / (f + 56)	2,9	5,3
	f > 14,5 13,1 / (f + 1)	f > 7,2 13,1 / (f + 1)			f > 12 13,1 / (f + 1)	f > 6 13,1 / (f + 1)		

Note: For R<sub>1,k</sub>, if the purlin is prevented from rotation, consider the value as the half of the one given for two brackets



Table D35-2 E6/2 - timber to timber connection – 2 angle brackets

Beam to beam connection				Modified characteristic capacity per connection (kN)				
Load duration	Partial nailing 5+4 (fig. D35-2 A)				Full nailing 11+6 (fig. D35-2 B)			
	R <sub>1,k</sub>		R <sub>2,k</sub> = R <sub>3,k</sub>		R <sub>1,k</sub>		R <sub>2,k</sub> = R <sub>3,k</sub>	
	Connector nail according to ETA-04/0013:				Connector nail according to ETA-04/0013:			
	4,0x35	4,0x60	4,0x35	4,0x60	4,0x35	4,0x60	4,0x35	4,0x60
<b>P</b>	1,5	2,9	2,4	4,4	2,5	5,0	3,2	5,7
<b>L</b>	1,7	3,5	2,8	5,1	3,0	5,8	3,7	6,7
<b>M</b>	2,0	3,9	3,2	5,8	3,3	6,7	4,2	7,7
<b>S</b>	2,2	4,4	3,6	6,6	3,8	7,5	4,7	8,7
<b>I</b>	2,7	5,4	4,4	8,0	4,6	9,2	5,8	10,6

Table D35-3 E6/2 – Post to beam connection

Column to beam connection Nailing 8+6 (bottom row of nails in vertical flap disregarded for $R_{1,k}$ )			Modified characteristic capacity per connection (kN)					
Load duration	1 Angle Bracket per connection				2 Angle Brackets per connection			
	$R_{1,k}$		$R_{2,k} = R_{3,k}$		$R_{1,k}$		$R_{2,k} = R_{3,k}$	
	Connector nail according to ETA-04/0013:							
	4,0x35	4,0x60	4,0x35	4,0x60	4,0x35	4,0x60	4,0x35	4,0x60
<b>P</b>	$f \leq 28,7$ $37 / (f + 56)$	$f \leq 13,3$ $75 / (f + 56)$	1,5	2,9	2,5	5,0	3,2	5,8
	$f > 28,7$ $13,1 / (f + 1)$	$f > 13,3$ $13,1 / (f + 1)$						
<b>L</b>	$f \leq 22,7$ $43 / (f + 56)$	$f \leq 10,8$ $87 / (f + 56)$	1,8	3,4	3,0	5,8	3,7	6,7
	$f > 22,7$ $13,1 / (f + 1)$	$f > 10,8$ $13,1 / (f + 1)$						
<b>M</b>	$f \leq 18,7$ $49 / (f + 56)$	$f \leq 9,1$ $99 / (f + 56)$	2,1	3,9	3,3	6,7	4,2	7,7
	$f > 18,7$ $13,1 / (f + 1)$	$f > 9,1$ $13,1 / (f + 1)$						
<b>S</b>	$f \leq 15,8$ $56 / (f + 56)$	$f \leq 7,8$ $112 / (f + 56)$	2,4	4,3	3,8	7,5	4,7	8,7
	$f > 15,8$ $13,1 / (f + 1)$	$f > 7,8$ $13,1 / (f + 1)$						
<b>I</b>	$f \leq 12$ $68 / (f + 56)$	$f \leq 6$ $136 / (f + 56)$	2,9	5,3	4,6	9,2	5,8	10,6
	$f > 12$ $13,1 / (f + 1)$	$f > 6$ $13,1 / (f + 1)$						

**Note:** For  $R_{1,k}$  for 1 angle bracket connection, if the purlin or column is prevented from rotation, consider the value as the half of the one given for two brackets.

Table D35-4 E6/2 - timber to rigid support connection – 2 angle brackets

Beam to rigid support connection Nailing 11+1 bolt (fig. 35-2 C)				Modified characteristic capacity per connection (kN)					
Load duration	1 angle bracket per connection				2 angle brackets per connection				
	R <sub>1,k</sub>		R <sub>2,k</sub> = R <sub>3,k</sub>		R <sub>1,k</sub>		R <sub>2,k</sub> = R <sub>3,k</sub>		
	Connector nail according to ETA-04/0013:				Connector nail according to ETA-04/0013:				
	4,0x35	4,0x60	4,0x35	4,0x60	4,0x35	4,0x60	4,0x35	4,0x60	
<b>P</b>	min of : 10,9 / ( f + 27 ) 13,1 / f			0,6	1,0	3,9	7,7	1,2	2,0
<b>L</b>				0,7	1,2	4,6	9,0	1,4	2,3
<b>M</b>				0,8	1,3	5,2	9,7	1,6	2,6
<b>S</b>				9,0	1,5	5,8	9,7	1,8	3,0
<b>I</b>				1,1	1,8	7,2	9,7	2,2	3,7

Note: For R<sub>1,k</sub> for 1 angle bracket connection, if the purlin or column is prevented from rotation, consider the value as the half of the one given for two brackets.

E6/2	connection with 1 angle brackets			
factor:	for F <sub>1</sub>	for F <sub>2/3</sub>	for F <sub>4</sub>	for F <sub>5</sub>
<b>k<sub>ax</sub></b>	(f+41)/8	0,53	-	-
<b>k<sub>lat</sub></b>	-	1,00	-	-

E6/2	connection with 2 angle brackets			
factor:	for F <sub>1</sub>	for F <sub>2/3</sub>	for F <sub>4/5</sub> , bolt 1	for F <sub>4/5</sub> , bolt 2
<b>k<sub>ax</sub></b>	1,02	0,27	-	-
<b>k<sub>lat</sub></b>	-	0,50	-	-

For each bolt it's needed to check:  $R_{bolt,d,lateral} \geq k_{lat} \times F_{i,d}$  ;  $R_{bolt,d,axial} \geq k_{ax} \times F_{i,d}$  ; and also the combination

Table D35-5 E6/2 - Post to rigid support connection

Column to rigid support connection Nailing 8+1 bolt (bottom row of nails in vertical flap disregarded for $R_{1,k}$ )					Modified characteristic capacity per connection (kN)			
Load duration	1 angle bracket per connection				2 angle brackets per connection			
	$R_{1,k}$		$R_{2,k} = R_{3,k}$		$R_{1,k}$		$R_{2,k} = R_{3,k}$	
	Connector nail according to ETA-04/0013:				Connector nail according to ETA-04/0013:			
	4,0x35	4,0x60	4,0x35	4,0x60	4,0x35	4,0x60	4,0x35	4,0x60
<b>P</b>	min of : $10,9 / (f + 27)$ $13,1 / f$		0,6	1,0	2,0	4,0	1,2	2,0
<b>L</b>			0,7	1,2	2,2	4,6	1,4	2,3
<b>M</b>			0,8	1,3	2,6	5,3	1,6	2,6
<b>S</b>			0,9	1,5	3,0	5,9	1,8	3,0
<b>I</b>			1,1	1,8	3,7	7,3	2,2	3,7

Note: For  $R_{1,k}$  for 1 angle bracket connection, if the purlin or column is prevented from rotation, consider the value as the half of the one given for two brackets.

Requirement for the bolts – see declaration under table D35-4

**Annex D36 – E6/2.5**

**Product Name:**

Product Name	Alternative name			
	UK	France	Denmark	Germany
E6/2.5	--	--	--	--

**Drawing:**

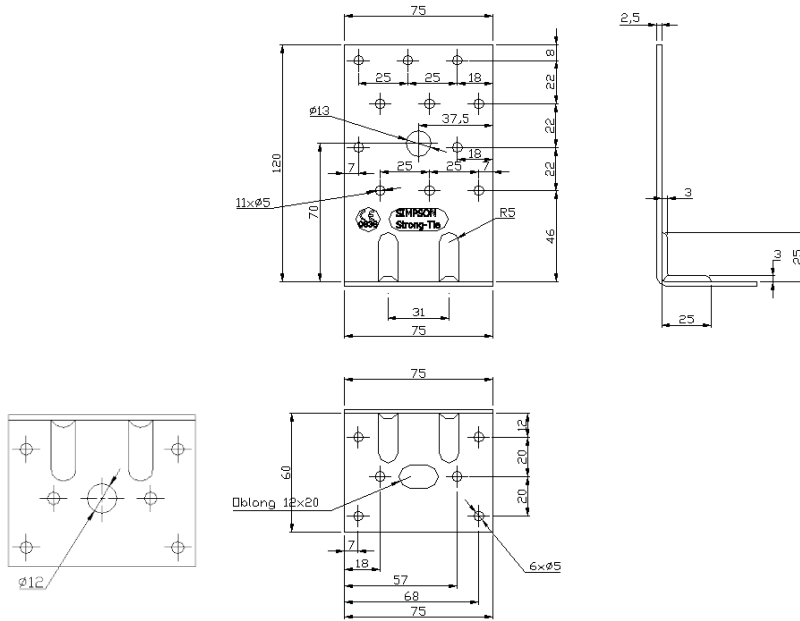

Figure D36-1: E6/2.5

Option: round hole or oblong hole

**Material**

Standard material : S250GD + Z275 according to EN 10346

Or stainless steel according to clause II-1

**Nail pattern:**

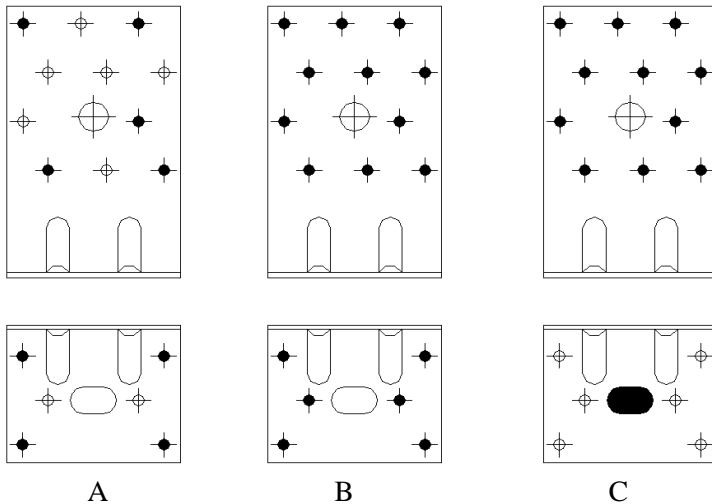

Figure D36-2 : E6/2.5 nails pattern  
 A – Beam to beam connection – Partial nailing  
 B – Beam to beam and Post to beam connection – Full nailing  
 C – Beam to rigid and Post to rigid support connection

**Modified characteristic capacities**

Table D36-1 E6/2.5 - timber to timber connection – 1 angle bracket

Beam to beam connection					Modified characteristic capacity per connection (kN)			
Load duration	Partial nailing 5+4 (fig. D36-2 A)				Full nailing 11+6 (fig. D36-2 B)			
	R <sub>1,k</sub>		R <sub>2,k</sub> = R <sub>3,k</sub>		R <sub>1,k</sub>		R <sub>2,k</sub> = R <sub>3,k</sub>	
	Connector nail according to ETA-04/0013:				Connector nail according to ETA-04/0013:			
	4,0x35	4,0x60	4,0x35	4,0x60	4,0x35	4,0x60	4,0x35	4,0x60
<b>P</b>	f ≤ 92,8 32 / ( f + 56 )	f ≤ 31,2 65 / ( f + 56 )	1,2	2,1	f ≤ 65,9 37 / ( f + 56 )	f ≤ 25 75 / ( f + 56 )	1,5	2,9
	f > 92,8 20,5 / ( f + 1 )	f > 31,2 20,5 / ( f + 1 )			f > 65,9 20,5 / ( f + 1 )	f > 25 20,5 / ( f + 1 )		
<b>L</b>	f ≤ 63,6 37 / ( f + 56 )	f ≤ 24,4 75 / ( f + 56 )	1,5	2,5	f ≤ 47,8 43 / ( f + 56 )	f ≤ 19,8 87 / ( f + 56 )	1,8	3,3
	f > 63,6 20,5 / ( f + 1 )	f > 24,4 20,5 / ( f + 1 )			f > 47,8 20,5 / ( f + 1 )	f > 19,8 20,5 / ( f + 1 )		
<b>M</b>	f ≤ 48,2 43 / ( f + 56 )	f ≤ 20 87 / ( f + 56 )	1,7	3	f ≤ 37,4 50 / ( f + 56 )	f ≤ 16,3 99 / ( f + 56 )	2,1	3,9
	f > 48,2 20,5 / ( f + 1 )	f > 20 20,5 / ( f + 1 )			f > 37,4 20,5 / ( f + 1 )	f > 16,3 20,5 / ( f + 1 )		
<b>S</b>	f ≤ 38,8 49 / ( f + 56 )	f ≤ 16,8 97 / ( f + 56 )	1,8	3,3	f ≤ 30,6 56 / ( f + 56 )	f ≤ 13,9 112 / ( f + 56 )	2,4	4,3
	f > 38,8 20,5 / ( f + 1 )	f > 16,8 20,5 / ( f + 1 )			f > 30,6 20,5 / ( f + 1 )	f > 13,9 20,5 / ( f + 1 )		
<b>I</b>	f ≤ 27,7 60 / ( f + 56 )	f ≤ 12,7 120 / ( f + 56 )	2,2	4,0	f ≤ 22,3 68 / ( f + 56 )	f ≤ 10,5 136 / ( f + 56 )	2,9	5,3
	f > 27,7 20,5 / ( f + 1 )	f > 12,7 20,5 / ( f + 1 )			f > 22,3 20,5 / ( f + 1 )	f > 10,5 20,5 / ( f + 1 )		

Note: For R<sub>1,k</sub>, if the purlin is prevented from rotation, consider the value as the half of the one given for two brackets.

Table D36-2 E6/2.5 - timber to timber connection – 2 brackets

Beam to beam connection - Characteristic capacity per connection (kN)									
Number of fasteners		R <sub>1,k</sub>				R <sub>2,k</sub>			
Joist	Support	4.0x35	4.0x40	4.0x50	4.0x60	4.0x35	4.0x40	4.0x50	4.0x60
2 x 11 nails	2 x 6 nails	5,5	6,3	7,2	7,6	9,4	10,3	12,5	13,3

Connector nail according to ETA-04/0013

Table D36-3 E6/2.5 - post to beam connection

Column to beam connection Nailing 8+6 (bottom row of nails in vertical flap disregarded for R <sub>1,k</sub> )			Modified characteristic capacity per connection (kN)					
Load duration	1 angle bracket per connection				2 angle brackets per connection			
	R <sub>1,k</sub>		R <sub>2,k</sub> = R <sub>3,k</sub>		R <sub>1,k</sub>		R <sub>2,k</sub> = R <sub>3,k</sub>	
	Connector nail according to ETA-04/0013: 4,0x35      4,0x60		4,0x35	4,0x60	Connector nail according to ETA-04/0013: 4,0x35      4,0x60		4,0x35	4,0x60
<b>P</b>	$f \leq 65,9$ $37 / (f + 56)$	$f \leq 25$ $75 / (f + 56)$	1,5	2,9	2,5	5,0	3,2	5,8
	$f > 65,9$ $20,5 / (f + 1)$	$f > 25$ $20,5 / (f + 1)$						
<b>L</b>	$f \leq 47,8$ $43 / (f + 56)$	$f \leq 19,8$ $87 / (f + 56)$	1,8	3,4	3,0	5,8	3,7	6,7
	$f > 47,8$ $20,5 / (f + 1)$	$f > 19,8$ $20,5 / (f + 1)$						
<b>M</b>	$f \leq 37,4$ $49 / (f + 56)$	$f \leq 16,3$ $99 / (f + 56)$	2,1	3,9	3,3	6,7	4,2	7,7
	$f > 37,4$ $20,5 / (f + 1)$	$f > 16,3$ $20,5 / (f + 1)$						
<b>S</b>	$f \leq 30,6$ $56 / (f + 56)$	$f \leq 13,9$ $112 / (f + 56)$	2,4	4,3	3,8	7,5	4,7	8,7
	$f > 30,6$ $20,5 / (f + 1)$	$f > 13,9$ $20,5 / (f + 1)$						
<b>I</b>	$f \leq 22,3$ $68 / (f + 56)$	$f \leq 10,5$ $136 / (f + 56)$	2,9	5,3	4,6	9,2	5,8	10,6
	$f > 22,3$ $20,5 / (f + 1)$	$f > 10,5$ $20,5 / (f + 1)$						

f in mm ;

**Note:** For R<sub>1,k</sub> for 1 angle bracket connection, if the purlin or column is prevented from rotation, consider the value as the half of the one given for two brackets.

Table D36-4 E6/2.5 - timber to rigid support connection  
 Beam to rigid connection, Nailing 11+1 bolt (fig D36-2)

Load duration	1 angle bracket per connection			
	R <sub>1,k</sub>		R <sub>2,k</sub> = R <sub>3,k</sub>	
	4,0x35	4,0x60	4,0x35	4,0x60
P	min of : 14,9 / ( f + 28 ) 20,5 / f		0,6	1,2
L			0,7	1,4
M			0,8	1,7
S			0,9	1,9
I			1,1	2,2

f in mm

Note: For R<sub>1,k</sub> for 1 angle bracket connection, if the purlin or column is prevented from rotation, consider the value as the half of the one given for two brackets.



Table D36-4a : E6/2.5 - timber to rigid support connection – 2 angle brackets

Beam to rigid support connection - Characteristic capacity per connection (kN)									
Number of fasteners		$R_{1,k}$				$R_{2,k}^*$			
Joist	Support	4.0x35	4.0x40	4.0x50	4.0x60	4.0x35	4.0x40	4.0x50	4.0x60
2 x 11 nails	2 x 1 bolt $\varnothing 10$	12,6	12,6	12,6	12,6	5,7	6,5	8,1	9,0

\*only available for a connection in a round hole, not with the version with oblong hole

E6/2,5	connection with 1 angle brackets			
factor:	for $F_1$	for $F_{2/3}$	for $F_4$	for $F_5$
$k_{ax}$	$(f+41,5)/8$	1,87	-	-
$k_{lat}$	-	1,00	-	-

E6/2,5	connection with 2 angle brackets			
factor:	for $F_1$	for $F_{2/3}$	for $F_{4/5}$ , bolt 1	for $F_{4/5}$ , bolt 2
$k_{ax}$	1,02	0,93	-	-
$k_{lat}$	-	0,50	-	-

For each bolt it's needed to check:  $R_{bolt,d,lateral} \geq k_{lat} \times F_{i,d}$  ;  $R_{bolt,d,axial} \geq k_{ax} \times F_{i,d}$  ; and also the combination

Table D36-5 E6/2.5 - Post to rigid support connection

Column to rigid support connection Nailing 8+1 bolt (bottom row of nails in vertical flap disregarded for $R_{1,k}$ )				Modified characteristic capacity per connection (kN)					
Load duration	1 angle bracket per connection			2 angle brackets per connection					
	$R_{1,k}$		$R_{2,k} = R_{3,k}$	$R_{1,k}$		$R_{2,k} = R_{3,k}$			
	Connector nail according to ETA-04/0013:				Connector nail according to ETA-04/0013:				
	4,0x35	4,0x60	4,0x35	4,0x60	4,0x35	4,0x60	4,0x35	4,0x60	
<b>P</b>	14,9 / ( f + 28 )			0,6	1,2	2,0	4,0	1,2	2,5
<b>L</b>				0,7	1,4	2,2	4,6	1,4	2,8
<b>M</b>				0,8	1,7	2,6	5,3	1,6	3,3
<b>S</b>				0,9	1,9	3,0	5,9	1,7	3,8
<b>I</b>				1,1	2,2	3,7	7,3	2,2	4,6

f in mm

Note: For  $R_{1,k}$  for 1 angle bracket connection, if the purlin or column is prevented from rotation, consider the value as the half of the one given for two brackets.

Requirement for the bolts – see declaration under table D36-4

**Annex D37 – E7/2.5**

**Product Name:**

Product Name	Alternative name			
	UK	France	Denmark	Germany
E7/2.5	--	--	--	--

**Drawing:**

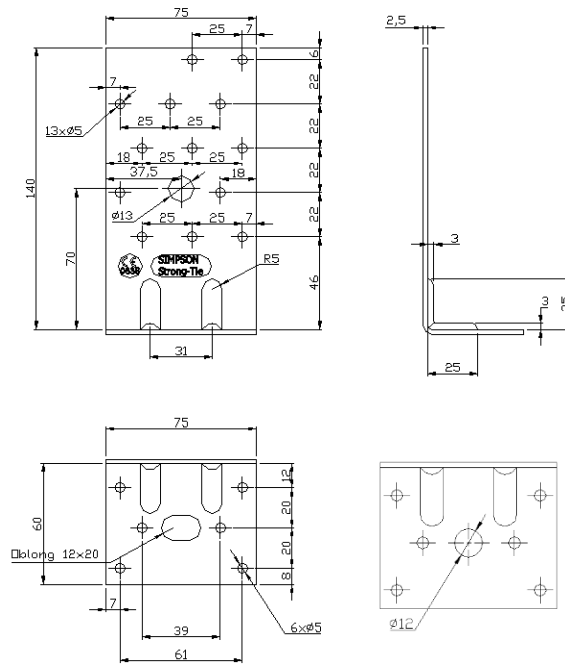

Option: round hole or oblong hole  
Figure D37-1: E7/2.5

**Material:**

Standard material : S250GD + Z275 according to EN 10346  
Or stainless steel according to clause II-1

**Nail pattern:**

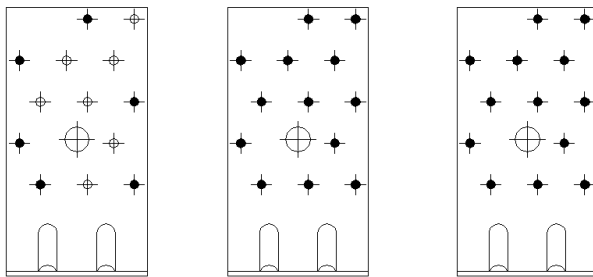
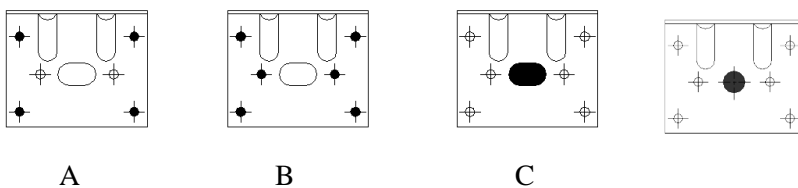

Figure D37-2 : E7/2.5 nails pattern  
A – Beam to beam connection – Partial nailing  
B – Beam to beam and Post to beam connection – Full nailing  
C – Beam to rigid and Post to rigid support connection



**Modified characteristic capacities:**

Table D37-1 E7/2.5 - timber to timber connection – 1 angle bracket

Beam to beam connection				Modified characteristic capacity per connection (kN)				
Load duration	Partial nailing 6+4 (fig. D37-2 A)				Full nailing 13+6 (fig. D37-2 B)			
	R <sub>1,k</sub>		R <sub>2,k</sub> = R <sub>3,k</sub>		R <sub>1,k</sub>		R <sub>2,k</sub> = R <sub>3,k</sub>	
	Connector nail according to ETA-04/0013:							
	4,0x35	4,0x60	4,0x35	4,0x60	4,0x35	4,0x60	4,0x35	4,0x60
<b>P</b>	$f \leq 92,8$ $32 / (f + 56)$	$f \leq 31,2$ $65 / (f + 56)$	1,3	2,5	$f \leq 65,9$ $37 / (f + 56)$	$f \leq 25$ $75 / (f + 56)$	2	3,7
	$f > 92,8$ $20,5 / (f + 1)$	$f > 31,2$ $20,5 / (f + 1)$			$f > 65,9$ $20,5 / (f + 1)$	$f > 25$ $20,5 / (f + 1)$		
<b>L</b>	$f \leq 63,6$ $37 / (f + 56)$	$f \leq 24,4$ $75 / (f + 56)$	1,5	2,9	$f \leq 47,8$ $43 / (f + 56)$	$f \leq 19,8$ $87 / (f + 56)$	2,3	4,4
	$f > 63,6$ $20,5 / (f + 1)$	$f > 24,4$ $20,5 / (f + 1)$			$f > 47,8$ $20,5 / (f + 1)$	$f > 19,8$ $20,5 / (f + 1)$		
<b>M</b>	$f \leq 48,2$ $43 / (f + 56)$	$f \leq 20$ $87 / (f + 56)$	1,7	3,4	$f \leq 37,4$ $49 / (f + 56)$	$f \leq 16,3$ $99 / (f + 56)$	2,6	5
	$f > 48,2$ $20,5 / (f + 1)$	$f > 20$ $20,5 / (f + 1)$			$f > 37,4$ $20,5 / (f + 1)$	$f > 16,3$ $20,5 / (f + 1)$		
<b>S</b>	$f \leq 38,8$ $48 / (f + 56)$	$f \leq 16,8$ $97 / (f + 56)$	1,9	3,8	$f \leq 30,6$ $56 / (f + 56)$	$f \leq 13,9$ $112 / (f + 56)$	3	5,6
	$f > 38,8$ $20,5 / (f + 1)$	$f > 16,8$ $20,5 / (f + 1)$			$f > 30,6$ $20,5 / (f + 1)$	$f > 13,9$ $20,5 / (f + 1)$		
<b>I</b>	$f \leq 27,7$ $59 / (f + 56)$	$f \leq 12,7$ $119 / (f + 56)$	2,3	4,6	$f \leq 22,3$ $68 / (f + 56)$	$f \leq 10,5$ $136 / (f + 56)$	3,7	6,9
	$f > 27,7$ $20,5 / (f + 1)$	$f > 12,7$ $20,5 / (f + 1)$			$f > 22,3$ $20,5 / (f + 1)$	$f > 10,5$ $20,5 / (f + 1)$		

**f in mm**Note: For R<sub>1,k</sub>, if the purlin is prevented from rotation, consider the value as the half of the one given for two brackets.

Table D37-2 E7/2.5 - timber to timber connection – 2 angle brackets

Beam to beam connection - Characteristic capacity per connection (kN)									
Number of fasteners		$R_{1,k}$				$R_{2,k}$			
Joist	Support	4.0x35	4.0x40	4.0x50	4.0x60	4.0x35	4.0x40	4.0x50	4.0x60
2 x 6 nails	2 x 4 nails	2,4	2,8	4,6	4,9	4,3	4,7	7,9	8,5
2 x 13 nails	2 x 6 nails	5,5	6,3	7,2	7,6	10,0	10,9	13,3	14,2

Connector nail according to ETA-04/0013

Table D37-3 E7/2.5 - Post to beam connection

Column to beam connection Nailing 10+6 (bottom row of nails in vertical flap disregarded for $R_{1,k}$ )		Modified characteristic capacity per connection (kN)							
Load duration	1 angle bracket per connection				2 angle brackets per connection				
	$R_{1,k}$		$R_{2,k} = R_{3,k}$		$R_{1,k}$		$R_{2,k} = R_{3,k}$		
	Connector nail according to ETA-04/0013:				Connector nail according to ETA-04/0013:				
	4,0x35	4,0x60	4,0x35	4,0x60	4,0x35	4,0x60	4,0x35	4,0x60	
<b>P</b>	$f \leq 65,9$ $37 / (f + 56)$	$f \leq 25$ $74 / (f + 56)$	1,8	3,7	2,5	5,0	3,7	7,3	
	$f > 65,9$ $20,5 / (f + 1)$	$f > 25$ $20,5 / (f + 1)$							
<b>L</b>	$f \leq 47,8$ $43 / (f + 56)$	$f \leq 19,8$ $87 / (f + 56)$	2,1	4,3	2,9	5,8	4,3	8,5	
	$f > 47,8$ $20,5 / (f + 1)$	$f > 19,8$ $20,5 / (f + 1)$							
<b>M</b>	$f \leq 37,4$ $49 / (f + 56)$	$f \leq 16,3$ $99 / (f + 56)$	2,5	4,8	3,3	6,7	4,9	9,8	
	$f > 37,4$ $20,5 / (f + 1)$	$f > 16,3$ $20,5 / (f + 1)$							
<b>S</b>	$f \leq 30,6$ $56 / (f + 56)$	$f \leq 13,9$ $112 / (f + 56)$	2,8	5,5	3,7	7,5	5,6	10,9	
	$f > 30,6$ $20,5 / (f + 1)$	$f > 13,9$ $20,5 / (f + 1)$							
<b>I</b>	$f \leq 22,3$ $68 / (f + 56)$	$f \leq 10,5$ $136 / (f + 56)$	3,4	6,7	4,5	9,2	6,8	13,4	
	$f > 22,3$ $20,5 / (f + 1)$	$f > 10,5$ $20,5 / (f + 1)$							

f in mm

Note: For  $R_{1,k}$  for 1 angle bracket connection, if the purlin or column is prevented from rotation, consider the value as the half of the one given for two brackets

Table D37-4 E7/2.5 - timber to rigid support connection (1 angle bracket / 2 angle bracket per connection)

Beam to rigid support connection - Characteristic capacity per connection (kN)									
Number of fasteners		$R_{1,k}$				$R_{2,k}^*$			
Joist	Support	4.0x35	4.0x40	4.0x50	4.0x60	4.0x35	4.0x40	4.0x50	4.0x60
1 x 13 nails	1 x 1 bolt $\varnothing 10$	19,2 / ((f+28)x $k_{mod}$ )				1,0	1,1	1,8	2,0
2 x 13 nails	2 x 1 bolt $\varnothing 10$	12,7	12,7	12,7	12,7	5,7	6,5	8,1	9,0

f in mm

\*only available for a connection in a round hole, not with the version with oblong hole

Note: For  $R_{1,k}$  for 1 angle bracket connection, if the purlin or column is prevented from rotation, consider the value as the half of the one given for two brackets.

E7/2,5	connection with 1 angle brackets			
factor:	for $F_1$	for $F_{2/3}$	for $F_4$	for $F_5$
$k_{ax}$	(f+41,5)/8	1,87	-	-
$k_{lat}$	-	1,00	-	-

E7/2,5	connection with 2 angle brackets			
factor:	for $F_1$	for $F_{2/3}$	for $F_{4/5}$ , bolt 1	for $F_{4/5}$ , bolt 2
$k_{ax}$	1,02	0,93	-	-
$k_{lat}$	-	0,50	-	-

For each bolt it's needed to check:  $R_{bolt,d,lateral} \geq k_{lat} \times F_{i,d}$  ;  $R_{bolt,d,axial} \geq k_{ax} \times F_{i,d}$  ; and also the combination

Table D37-5 E7/2.5 - Post to rigid support connection

Column to rigid support connection Nailing 10+1 bolt (bottom row of nails in vertical flap disregarded for $R_{1,k}$ )					Modified characteristic capacity per connection (kN)			
Load duration	1 angle bracket per connection				2 angle brackets per connection			
	$R_{1,k}$		$R_{2,k} = R_{3,k}$		$R_{1,k}$		$R_{2,k} = R_{3,k}$	
	Connector nail according to ETA-04/0013:				Connector nail according to ETA-04/0013:			
	4,0x35	4,0x60	4,0x35	4,0x60	4,0x35	4,0x60	4,0x35	4,0x60
<b>P</b>	$f \leq 23,4$ $8 / f$	$19,2 / (f + 28)$	0,6	1,2	2,0	4,0	1,1	2,5
	$f > 23,4$ $19,2 / (f + 28)$							
<b>L</b>	$f \leq 31,9$ $10 / f$		0,7	1,4	2,3	4,6	1,4	2,8
	$f > 31,9$ $19,2 / (f + 28)$							
<b>M</b>	$f \leq 43,6$ $11 / f$		0,8	1,7	2,6	5,3	1,6	3,3
	$f > 43,6$ $19,2 / (f + 28)$							
<b>S</b>	$f \leq 61,2$ $13 / f$		0,9	1,9	3,0	6,0	1,8	3,7
	$f > 61,2$ $19,2 / (f + 28)$							
<b>I</b>	$f \leq 148$ $16,2 / f$		1,1	2,2	3,7	7,3	2,2	4,6
	$f > 148$ $19,2 / (f + 28)$							

f in mm

Note: For  $R_{1,k}$  for 1 angle bracket connection, if the purlin or column is prevented from rotation, consider the value as the half of the one given for two brackets.

Requirement for the bolts – see declaration under table D37-4



**Annex D38 – E8/2.5**

**Product Name:**

Product Name	Alternative name			
	UK	France	Denmark	Germany
E8/2.5	--	--	--	--

**Drawing:**

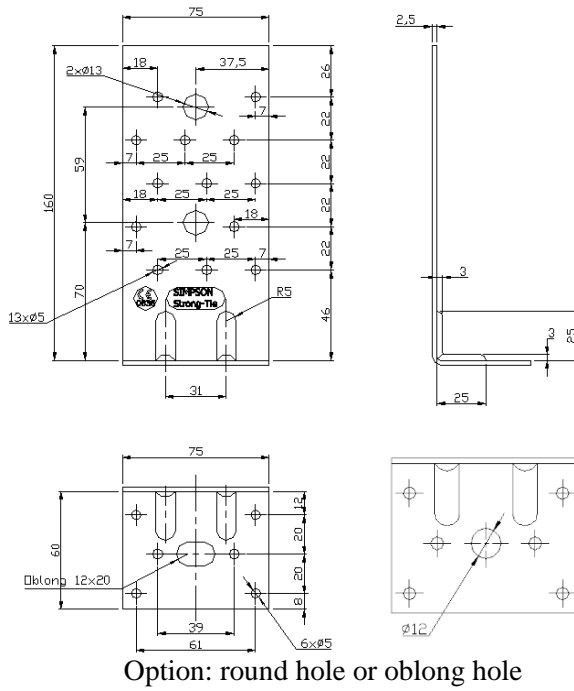

Figure D38-1: E8/2.5

**Material:**

Standard material : S250GD + Z275 according to EN 10346  
 Or stainless steel according to clause II-1

**Nail pattern:**

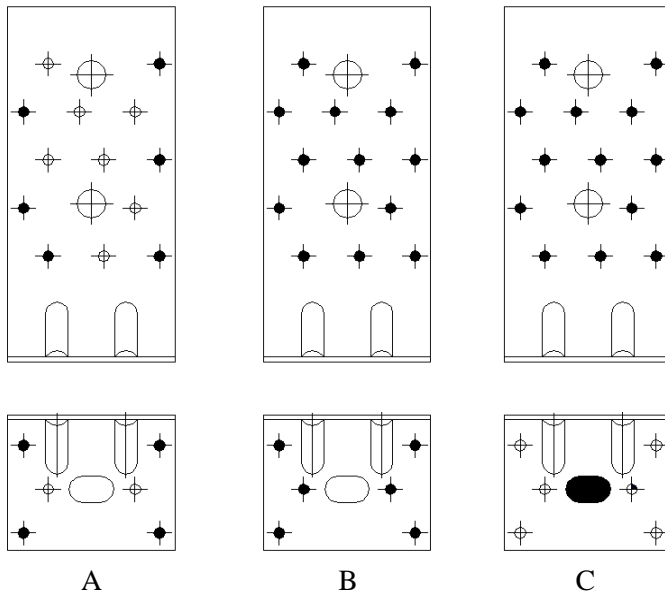

Figure D38-2 : E8/2.5 nails pattern  
 A – Beam to beam connection – Partial nailing  
 B – Beam to beam and Post to beam connection – Full nailing  
 C – Beam to rigid and Post to rigid support connection

**Modified characteristic capacities:**

Table D38-1 E8/2.5 - timber to timber connection – 1 angle bracket

Beam to beam connection				Modified characteristic capacity per connection (kN)				
Load duration	Partial nailing 6+4 (fig. D38-2 A)				Full nailing 13+6 (fig. D38-2 B)			
	R <sub>1,k</sub>		R <sub>2,k</sub> = R <sub>3,k</sub>		R <sub>1,k</sub>		R <sub>2,k</sub> = R <sub>3,k</sub>	
	Connector nail according to ETA-04/0013:							
	4,0x35	4,0x60	4,0x35	4,0x60	4,0x35	4,0x60	4,0x35	4,0x60
<b>P</b>	$f \leq 92,8$ $32 / (f + 56)$	$f \leq 31,2$ $65 / (f + 56)$	1,3	2,5	$f \leq 65,9$ $37 / (f + 56)$	$f \leq 25$ $75 / (f + 56)$	2	3,7
	$f > 92,8$ $20,5 / (f + 1)$	$f > 31,2$ $20,5 / (f + 1)$			$f > 65,9$ $20,5 / (f + 1)$	$f > 25$ $20,5 / (f + 1)$		
<b>L</b>	$f \leq 63,6$ $37 / (f + 56)$	$f \leq 24,4$ $75 / (f + 56)$	1,5	2,9	$f \leq 47,8$ $43 / (f + 56)$	$f \leq 19,8$ $87 / (f + 56)$	2,3	4,4
	$f > 63,6$ $20,5 / (f + 1)$	$f > 24,4$ $20,5 / (f + 1)$			$f > 47,8$ $20,5 / (f + 1)$	$f > 19,8$ $20,5 / (f + 1)$		
<b>M</b>	$f \leq 48,2$ $43 / (f + 56)$	$f \leq 20$ $87 / (f + 56)$	1,7	3,4	$f \leq 37,4$ $49 / (f + 56)$	$f \leq 16,3$ $99 / (f + 56)$	2,6	5
	$f > 48,2$ $20,5 / (f + 1)$	$f > 20$ $20,5 / (f + 1)$			$f > 37,4$ $20,5 / (f + 1)$	$f > 16,3$ $20,5 / (f + 1)$		
<b>S</b>	$f \leq 38,8$ $48 / (f + 56)$	$f \leq 16,8$ $97 / (f + 56)$	1,9	3,8	$f \leq 30,6$ $56 / (f + 56)$	$f \leq 13,9$ $112 / (f + 56)$	3	5,6
	$f > 38,8$ $20,5 / (f + 1)$	$f > 16,8$ $20,5 / (f + 1)$			$f > 30,6$ $20,5 / (f + 1)$	$f > 13,9$ $20,5 / (f + 1)$		
<b>I</b>	$f \leq 27,7$ $59 / (f + 56)$	$f \leq 12,7$ $119 / (f + 56)$	2,3	4,6	$f \leq 22,3$ $68 / (f + 56)$	$f \leq 10,5$ $136 / (f + 56)$	3,7	6,9
	$f > 27,7$ $20,5 / (f + 1)$	$f > 12,7$ $20,5 / (f + 1)$			$f > 22,3$ $20,5 / (f + 1)$	$f > 10,5$ $20,5 / (f + 1)$		

f in mm

Note: For R<sub>1,k</sub>, if the purlin is prevented from rotation, consider the value as the half of the one given for two brackets.

Table D38-2 E8/2.5 - timber to timber connection – 2 angle brackets (partial- / full nailing)

Beam to beam connection - Characteristic capacity per connection (kN)									
Number of fasteners		R <sub>1,k</sub>				R <sub>2,k</sub>			
Joist	Support	4.0x35	4.0x40	4.0x50	4.0x60	4.0x35	4.0x40	4.0x50	4.0x60
2 x 6 nails	2 x 4 nails	<b>2,4</b>	2,8	4,1	<b>4,3</b>	<b>4,3</b>	4,7	8,0	<b>8,5</b>
2 x 13 nails	2 x 6 nails	5,5	6,3	7,2	7,6	10,0	10,9	13,3	14,2

**Connector nail according to ETA-04/0013**

Table D38-3 E8/2.5 - Post to beam connection

Column to beam connection Nailing 10+6 (bottom row of nails in vertical flap disregarded for $R_{1,k}$ )			Modified characteristic capacity per connection (kN)					
Load duration	1 angle bracket per connection				2 angle brackets per connection			
	$R_{1,k}$		$R_{2,k} = R_{3,k}$		$R_{1,k}$		$R_{2,k} = R_{3,k}$	
	Connector nail according to ETA-04/0013:				Connector nail according to ETA-04/0013:			
	4,0x35	4,0x60	4,0x35	4,0x60	4,0x35	4,0x60	4,0x35	4,0x60
<b>P</b>	$f \leq 65,9$ $37 / (f + 56)$	$f \leq 25$ $74 / (f + 56)$	1,8	3,7	2,5	5,0	3,7	7,3
	$f > 65,9$ $20,5 / (f + 1)$	$f > 25$ $20,5 / (f + 1)$						
<b>L</b>	$f \leq 47,8$ $43 / (f + 56)$	$f \leq 19,8$ $87 / (f + 56)$	2,1	4,3	2,9	5,8	4,3	8,5
	$f > 47,8$ $20,5 / (f + 1)$	$f > 19,8$ $20,5 / (f + 1)$						
<b>M</b>	$f \leq 37,4$ $49 / (f + 56)$	$f \leq 16,3$ $99 / (f + 56)$	2,5	4,8	3,3	6,7	4,9	9,8
	$f > 37,4$ $20,5 / (f + 1)$	$f > 16,3$ $20,5 / (f + 1)$						
<b>S</b>	$f \leq 30,6$ $56 / (f + 56)$	$f \leq 13,9$ $112 / (f + 56)$	2,8	5,5	3,7	7,5	5,6	10,9
	$f > 30,6$ $20,5 / (f + 1)$	$f > 13,9$ $20,5 / (f + 1)$						
<b>I</b>	$f \leq 22,3$ $68 / (f + 56)$	$f \leq 10,5$ $136 / (f + 56)$	3,4	6,7	4,5	9,2	6,8	13,4
	$f > 22,3$ $20,5 / (f + 1)$	$f > 10,5$ $20,5 / (f + 1)$						

f in mm

Note: For  $R_{1,k}$  for 1 angle bracket connection, if the purlin or column is prevented from rotation, consider the value as the half of the one given for two brackets

Table D38-4 E8/2.5 - timber to rigid support connection (1 angle bracket / 2 angle bracket per connection)

Beam to rigid support connection - Characteristic capacity per connection (kN)									
Number of fasteners		$R_{1,k}$				$R_{2,k}^*$			
Joist	Support	4.0x35	4.0x40	4.0x50	4.0x60	4.0x35	4.0x40	4.0x50	4.0x60
1 x 13 nails	1 x 1 bolt $\varnothing 10$	19,2 / ((f+28)xk <sub>mod</sub> )				1,0	1,1	1,8	2,0
2 x 13 nails	2 x 1 bolt $\varnothing 10$	12,7	12,7	12,7	12,7	5,7	6,5	8,1	9,0

f in mm

\*only available for a connection in a round hole, not with the version with oblong hole

Note: For  $R_{1,k}$  for 1 angle bracket connection, if the purlin or column is prevented from rotation, consider the value as the half of the one given for two brackets.

E8/2,5	connection with 1 angle brackets			
factor:	for $F_1$	for $F_{2/3}$	for $F_4$	for $F_5$
$k_{ax}$	(f+41,5)/8	1,87	-	-
$k_{lat}$	-	1,00	-	-

E8/2,5	connection with 2 angle brackets			
factor:	for $F_1$	for $F_{2/3}$	for $F_{4/5}$ , bolt 1	for $F_{4/5}$ , bolt 2
$k_{ax}$	1,02	0,93	-	-
$k_{lat}$	-	0,50	-	-

For each bolt it's needed to check:  $R_{bolt,d,lateral} \geq k_{lat} \times F_{i,d}$  ;  $R_{bolt,d,axial} \geq k_{ax} \times F_{i,d}$  ; and also the combination

Table D38-5 E8/2.5 - Post to rigid support connection

Column to rigid support connection (Nails 1,2 and 12 disregarded for $R_{1,k}$ )					Characteristic capacity per connection (kN)			
Load duration	1 angle bracket per connection				2 angle brackets per connection			
	$R_{1,k}$		$R_{2,k} = R_{3,k}$		$R_{1,k}$		$R_{2,k} = R_{3,k}$	
	Connector nail according to ETA-04/0013:				Connector nail according to ETA-04/0013:			
	4,0x35	4,0x60	4,0x35	4,0x60	4,0x35	4,0x60	4,0x35	4,0x60
<b>P</b>	$f \leq 23,4$ $8 / f$	$19,2 / (f + 28)$	0,6	1,2	2,0	4,0	1,1	2,5
	$f > 23,4$ $19,2 / (f + 28)$							
<b>L</b>	$f \leq 31,9$ $10 / f$		0,7	1,4	2,3	4,6	1,4	2,8
	$f > 31,9$ $19,2 / (f + 28)$							
<b>M</b>	$f \leq 43,6$ $11 / f$		0,8	1,7	2,6	5,3	1,6	3,3
	$f > 43,6$ $19,2 / (f + 28)$							
<b>S</b>	$f \leq 61,2$ $13 / f$		0,9	1,9	3,0	6,0	1,8	3,7
	$f > 61,2$ $19,2 / (f + 28)$							
<b>I</b>	$f \leq 148$ $16,2 / f$		1,1	2,2	3,7	7,3	2,2	4,6
	$f > 148$ $19,2 / (f + 28)$							

f in mm

Note: For  $R_{1,k}$  for 1 angle bracket connection, if the purlin or column is prevented from rotation, consider the value as the half of the one given for two brackets.

Requirement for the bolts – see declaration under table D38-4

**Annex D39 – E14/2**

**Product Name:**

Product Name	Alternative name			
	UK	France	Denmark	Germany
E14/2	--	--	--	--

**Drawing:**

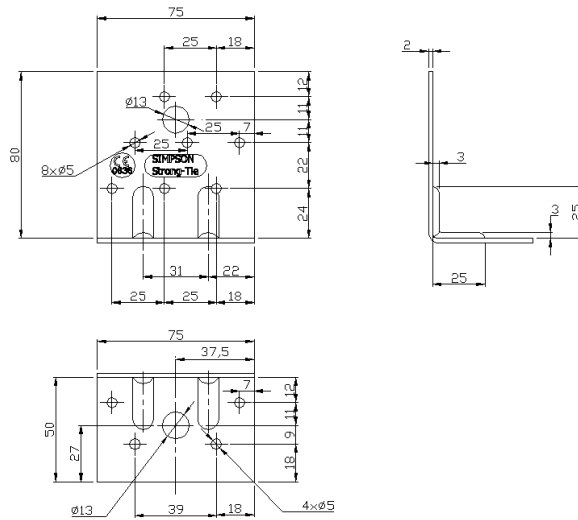

Figure D39-1: E14/2

**Material:**

Standard material : S250GD + Z275 according to EN 10346

Or stainless steel according to clause II-1

**Nail pattern:**

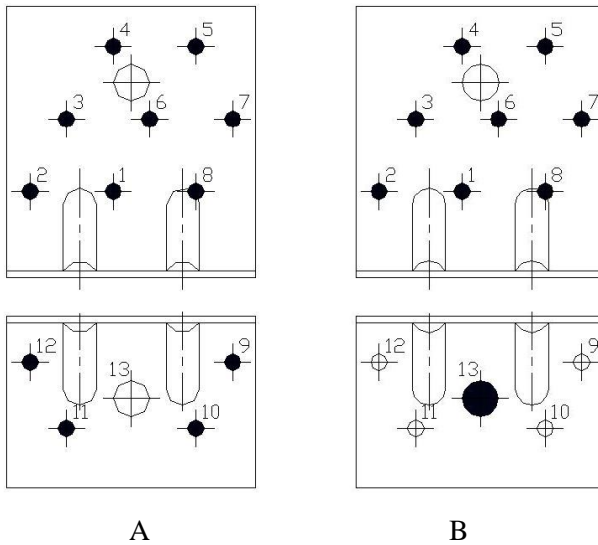

Figure D39-2 : E14/2 nails pattern  
 A – Beam to beam connection  
 B – Beam to rigid support

**Modified characteristic capacities:**

Table D39-1 E14/2 - timber to timber connection

Beam to beam connection				Modified characteristic capacity per connection (kN)				
Load duration	1 angle bracket per connection				2 angle brackets per connection			
	R <sub>1,k</sub>		R <sub>2,k</sub> = R <sub>3,k</sub>		R <sub>1,k</sub>		R <sub>2,k</sub> = R <sub>3,k</sub>	
	Connector nail according to ETA-04/0013:				Connector nail according to ETA-04/0013:			
	4,0x35	4,0x60	4,0x35	4,0x60	4,0x35	4,0x60	4,0x35	4,0x60
<b>P</b>	$f \leq 65,3$ $20 / (f + 39)$	$f \leq 21,6$ $40 / (f + 39)$	1,6	2,8	2,5	5,0	3,2	5,8
	$f > 65,3$ $13,1 / (f + 1)$	$f > 21,6$ $13,1 / (f + 1)$						
<b>L</b>	$f \leq 44,5$ $23 / (f + 39)$	$f \leq 16,9$ $47 / (f + 39)$	1,8	3,4	2,9	5,8	3,7	6,8
	$f > 44,5$ $13,1 / (f + 1)$	$f > 16,9$ $13,1 / (f + 1)$						
<b>M</b>	$f \leq 33,6$ $27 / (f + 39)$	$f \leq 13,8$ $54 / (f + 39)$	2,1	3,8	3,3	6,7	4,3	7,7
	$f > 33,6$ $13,1 / (f + 1)$	$f > 13,8$ $13,1 / (f + 1)$						
<b>S</b>	$f \leq 27$ $31 / (f + 39)$	$f \leq 11,6$ $61 / (f + 39)$	2,4	4,4	3,7	7,5	4,8	8,7
	$f > 27$ $13,1 / (f + 1)$	$f > 11,6$ $13,1 / (f + 1)$						
<b>I</b>	$f \leq 19,2$ $37 / (f + 39)$	$f \leq 8,7$ $75 / (f + 39)$	2,9	5,3	4,5	9,2	5,9	10,7
	$f > 19,2$ $13,1 / (f + 1)$	$f > 8,7$ $13,1 / (f + 1)$						

f in mm

Note: For R<sub>1,k</sub> for 1 angle bracket connection, if the purlin or column is prevented from rotation, consider the value as the half of the one given for two brackets.



Table D39-2 E14/2 - timber to rigid connection

Beam to rigid support connection				Modified characteristic capacity per connection (kN)				
Load duration	1 angle bracket per connection				2 angle brackets per connection			
	R <sub>1,k</sub>		R <sub>2,k</sub> = R <sub>3,k</sub>		R <sub>1,k</sub>		R <sub>2,k</sub> = R <sub>3,k</sub>	
	Connector nail according to ETA-04/0013: 4,0x35   4,0x60				Connector nail according to ETA-04/0013: 4,0x35   4,0x60			
<b>P</b>	min of :  26,5 / ( f + 17 )  11,3 / f		1,0	2,0	2,1	4,2	2,0	4,2
<b>L</b>			1,1	2,4	2,5	4,9	2,3	4,8
<b>M</b>			1,4	2,8	2,8	5,6	2,7	5,5
<b>S</b>			1,5	3,1	3,2	6,4	3,1	6,3
<b>I</b>			1,8	8,0	3,9	6,9	3,7	7,6

f in mm

Note: For R<sub>1,k</sub> for 1 angle bracket connection, if the purlin or column is prevented from rotation, consider the value as the half of the one given for two brackets.

<b>E14/2</b>	connection with 1 angle brackets			
factor:	for F <sub>1</sub>	for F <sub>2/3</sub>	for F <sub>4</sub>	for F <sub>5</sub>
<b>k<sub>ax</sub></b>	(f+33)/9	1,04	-	-
<b>k<sub>lat</sub></b>	-	1,00	-	-

<b>E14/2</b>	connection with 2 angle brackets			
factor:	for F <sub>1</sub>	for F <sub>2/3</sub>	for F <sub>4/5, bolt 1</sub>	for F <sub>4/5, bolt 2</sub>
<b>k<sub>ax</sub></b>	0,99	0,52	-	-
<b>k<sub>lat</sub></b>	-	0,50	-	-

For each bolt it's needed to check:  $R_{\text{bolt},d,\text{lateral}} \geq k_{\text{lat}} \times F_{i,d}$  ;  $R_{\text{bolt},d,\text{axial}} \geq k_{\text{ax}} \times F_{i,d}$  ; and also the combination

**Annex D40 – E17/2**

**Product Name:**

Product Name	Alternative name			
	UK	France	Denmark	Germany
E17/2	--	--	--	--

**Drawing:**

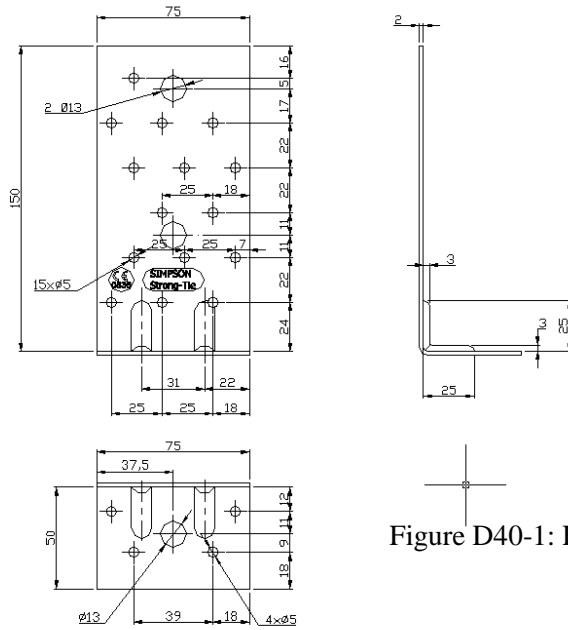

Figure D40-1: E17/2

**Material:**

Standard material : S250GD + Z275 according to EN 10346

Or stainless steel according to clause II-1

**Nail pattern:**

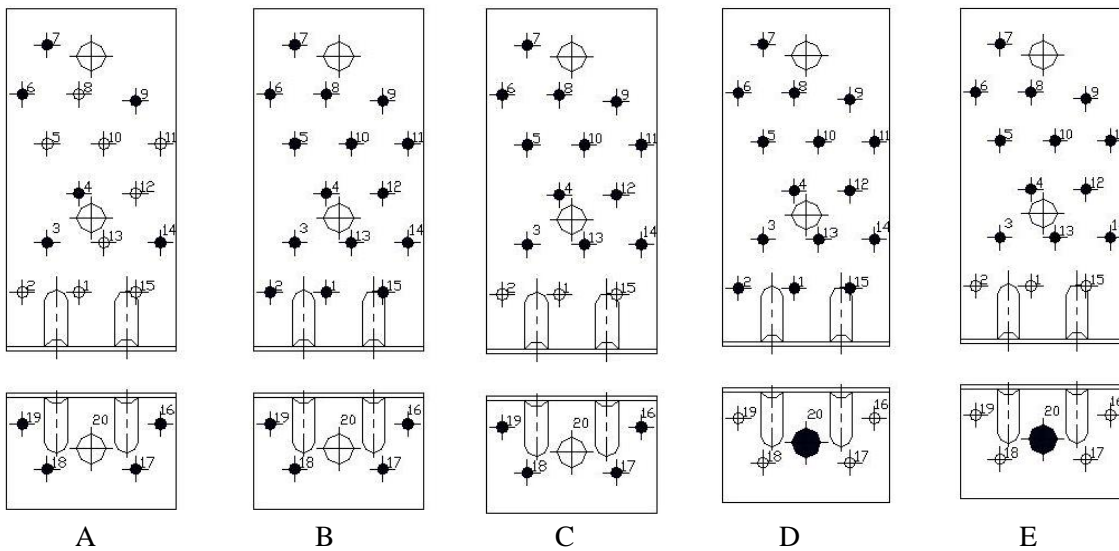

Figure D40-2 : E17/2 nails pattern

A – Beam to beam connection – Partial nailing

B – Beam to beam connection – Full nailing

C – Post to beam connection

D – Beam to rigid support connection

E – Post to rigid connection

**Modified characteristic capacities:**

Table D40-1 E17/2 - timber to timber connection – 1 angle bracket

Beam to beam connection				Modified characteristic capacity per connection (kN)				
Load duration	Partial nailing 6+4 (fig. D40-2 A)				Full nailing 15+4 (fig. D40-2 B)			
	R <sub>1,k</sub>		R <sub>2,k</sub> = R <sub>3,k</sub>		R <sub>1,k</sub>		R <sub>2,k</sub> = R <sub>3,k</sub>	
	Connector nail according to ETA-04/0013:				Connector nail according to ETA-04/0013:			
	4,0x35	4,0x60	4,0x35	4,0x60	4,0x35	4,0x60	4,0x35	4,0x60
<b>P</b>	$f \leq 65,3$ $20 / (f + 39)$	$f \leq 21,6$ $40 / (f + 39)$	1,2	2,3	$f \leq 65,3$ $20 / (f + 39)$	$f \leq 21,6$ $40 / (f + 39)$	2,1	3,6
	$f > 65,3$ $13,1 / (f + 1)$	$f > 21,6$ $13,1 / (f + 1)$			$f > 65,3$ $13,1 / (f + 1)$	$f > 21,6$ $13,1 / (f + 1)$		
<b>L</b>	$f \leq 44,5$ $23 / (f + 39)$	$f \leq 16,9$ $47 / (f + 39)$	1,4	2,7	$f \leq 44,5$ $23 / (f + 39)$	$f \leq 16,9$ $47 / (f + 39)$	2,4	4,1
	$f > 44,5$ $13,1 / (f + 1)$	$f > 16,9$ $13,1 / (f + 1)$			$f > 44,5$ $13,1 / (f + 1)$	$f > 16,9$ $13,1 / (f + 1)$		
<b>M</b>	$f \leq 33,6$ $27 / (f + 39)$	$f \leq 13,8$ $54 / (f + 39)$	1,7	3,1	$f \leq 33,6$ $37 / (f + 39)$	$f \leq 13,8$ $54 / (f + 39)$	2,8	4,7
	$f > 33,6$ $13,1 / (f + 1)$	$f > 13,8$ $13,1 / (f + 1)$			$f > 33,6$ $13,1 / (f + 1)$	$f > 13,8$ $13,1 / (f + 1)$		
<b>S</b>	$f \leq 27$ $31 / (f + 39)$	$f \leq 11,6$ $61 / (f + 39)$	1,9	3,5	$f \leq 27$ $31 / (f + 39)$	$f \leq 11,6$ $61 / (f + 39)$	3,1	5,3
	$f > 27$ $13,1 / (f + 1)$	$f > 11,6$ $13,1 / (f + 1)$			$f > 27$ $13,1 / (f + 1)$	$f > 11,6$ $13,1 / (f + 1)$		
<b>I</b>	$f \leq 19,2$ $37 / (f + 39)$	$f \leq 8,7$ $75 / (f + 39)$	2,3	4,3	$f \leq 19,2$ $37 / (f + 39)$	$f \leq 8,7$ $75 / (f + 39)$	3,8	6,5
	$f > 19,2$ $13,1 / (f + 1)$	$f > 8,7$ $13,1 / (f + 1)$			$f > 19,2$ $13,1 / (f + 1)$	$f > 8,7$ $13,1 / (f + 1)$		

f in mm

Note: For R<sub>1,k</sub>, if the purlin is prevented from rotation, consider the value as the half of the one given for two brackets

Table D40-2 E17/2 - timber to timber connection – 2 brackets (partial- / full nailing)

Beam to beam connection - Characteristic capacity per connection (kN)									
Number of fasteners		$R_{1,k}$				$R_{2,k}$			
Joist	Support	4.0x35	4.0x40	4.0x50	4.0x60	4.0x35	4.0x40	4.0x50	4.0x60
2 x 6 nails	2 x 4 nails	4,1	4,7	7,5	8,3	4,3	4,7	7,3	7,8
2 x 15 nails	2 x 4 nails	4,9	5,6	6,7	7,4	8,2	9,0	10,9	11,6

Connector nail according to ETA-04/0013

Table D40-3 E17/2 - post to beam connection

Column to beam connection Nailing 12+4 (fig. D40-2 C)				Modified characteristic capacity per connection (kN)				
Load duration	1 Angle Bracket per connection				2 Angle Brackets per connection			
	R <sub>1,k</sub>		R <sub>2,k</sub> = R <sub>3,k</sub>		R <sub>1,k</sub>		R <sub>2,k</sub> = R <sub>3,k</sub>	
	Connector nail according to ETA-04/0013:				Connector nail according to ETA-04/0013:			
	4,0x35	4,0x60	4,0x35	4,0x60	4,0x35	4,0x60	4,0x35	4,0x60
<b>P</b>	$f \leq 65,3$ $21 / (f + 39)$	$f \leq 21,6$ $40 / (f + 39)$	2	3,4	2,5	5,0	4	6,8
	$f > 65,3$ $13,1 / (f + 1)$	$f > 21,6$ $13,1 / (f + 1)$						
<b>L</b>	$f \leq 44,5$ $23 / (f + 39)$	$f \leq 16,9$ $47 / (f + 39)$	2,3	4	2,9	5,8	4,6	8
	$f > 44,5$ $13,1 / (f + 1)$	$f > 16,9$ $13,1 / (f + 1)$						
<b>M</b>	$f \leq 33,6$ $27 / (f + 39)$	$f \leq 13,8$ $54 / (f + 39)$	2,6	4,6	3,3	6,7	5,4	9,1
	$f > 33,6$ $13,1 / (f + 1)$	$f > 13,8$ $13,1 / (f + 1)$						
<b>S</b>	$f \leq 27$ $31 / (f + 39)$	$f \leq 11,6$ $61 / (f + 39)$	3	5,1	3,7	7,5	6	10,2
	$f > 27$ $13,1 / (f + 1)$	$f > 11,6$ $13,1 / (f + 1)$						
<b>I</b>	$f \leq 19,2$ $37 / (f + 39)$	$f \leq 8,7$ $75 / (f + 39)$	3,7	6,3	4,5	9,2	7,4	12,6
	$f > 19,2$ $13,1 / (f + 1)$	$f > 8,7$ $13,1 / (f + 1)$						

f in mm

Note: For R<sub>1,k</sub> for 1 angle bracket connection, if the purlin or column is prevented from rotation, consider the value as the half of the one given for two brackets

Table D40-4 E17/2 - beam to rigid support connection (1 angle bracket / 2 angle bracket per connection)

Beam to rigid support connection - Characteristic capacity per connection (kN)									
Number of fasteners		$R_{1,k}$				$R_{2,k}$			
Joist	Support	4.0x35	4.0x40	4.0x50	4.0x60	4.0x35	4.0x40	4.0x50	4.0x60
1 x 15 nails	1 x 1 bolt $\varnothing 10$	min of: $26,5/((f+17) \times k_{mod})$ ; $11,3/(f \times k_{mod})$				1,7	2,0	3,1	3,5
2 x 15 nails	2 x 1 bolt $\varnothing 10$	$15,2/k_{mod}$				5,8	6,6	8,3	9,4

f in mm

Note: For  $R_{1,k}$  for 1 angle bracket connection, if the purlin or column is prevented from rotation, consider the value as the half of the one given for two brackets.

E17/2	connection with 1 angle brackets			
factor:	for $F_1$	for $F_{2/3}$	for $F_4$	for $F_5$
$k_{ax}$	$(f+33)/9$	1,82	-	-
$k_{lat}$	-	1,00	-	-

E17/2	connection with 2 angle brackets			
factor:	for $F_1$	for $F_{2/3}$	for $F_{4/5}$ , bolt 1	for $F_{4/5}$ , bolt 2
$k_{ax}$	0,99	0,91	-	-
$k_{lat}$	-	0,50	-	-

For each bolt it's needed to check:  $R_{bolt,d,lateral} \geq k_{lat} \times F_{i,d}$  ;  $R_{bolt,d,axial} \geq k_{ax} \times F_{i,d}$  ; and also the combination

Table D40-5 E17/2 - post to rigid support connection

Column to rigid support connection Nailing 12+1 bolt (fig. D40-2 E)				Modified characteristic capacity per connection (kN)					
Load duration	1 angle bracket per connection			2 angle brackets per connection					
	R <sub>1,k</sub>		R <sub>2,k</sub> = R <sub>3,k</sub>		R <sub>1,k</sub>		R <sub>2,k</sub> = R <sub>3,k</sub>		
	Connector nail according to ETA-04/0013: 4,0x35   4,0x60		Connector nail according to ETA-04/0013: 4,0x35   4,0x60		Connector nail according to ETA-04/0013: 4,0x35   4,0x60		Connector nail according to ETA-04/0013: 4,0x35   4,0x60		
<b>P</b>	min of :  26,5 / ( f + 17 )  11,3 / f			1,0	1,7	6,1	11,7	2,0	3,4
<b>L</b>				1,2	1,9	7,1	13,6	2,4	3,9
<b>M</b>				1,4	2,2	8,2	14,2	2,8	4,5
<b>S</b>				1,5	2,5	9,2	14,2	3,1	5,1
<b>I</b>				1,9	3,1	11,2	14,2	3,8	6,2

f in mm

Note: For R<sub>1,k</sub> for 1 angle bracket connection, if the purlin or column is prevented from rotation, consider the value as the half of the one given for two brackets.

Requirement for the bolts – see declaration under table D40-4

**Annex D41 – E18/2.5**

**Product Name:**

Product Name	Alternative name			
	UK	France	Denmark	Germany
E18/2.5	--	--	--	--

**Drawing:**

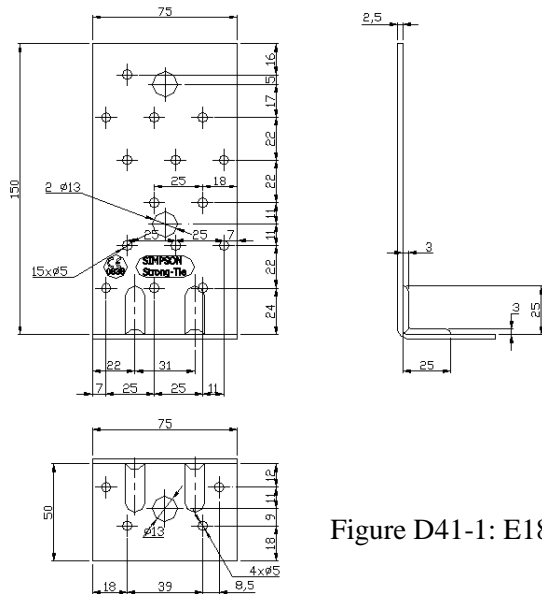

Figure D41-1: E18/2.5

**Material:**

Standard material : S250GD + Z275 according to EN 10346  
 Or stainless steel according to clause II-1

**Nail pattern:**

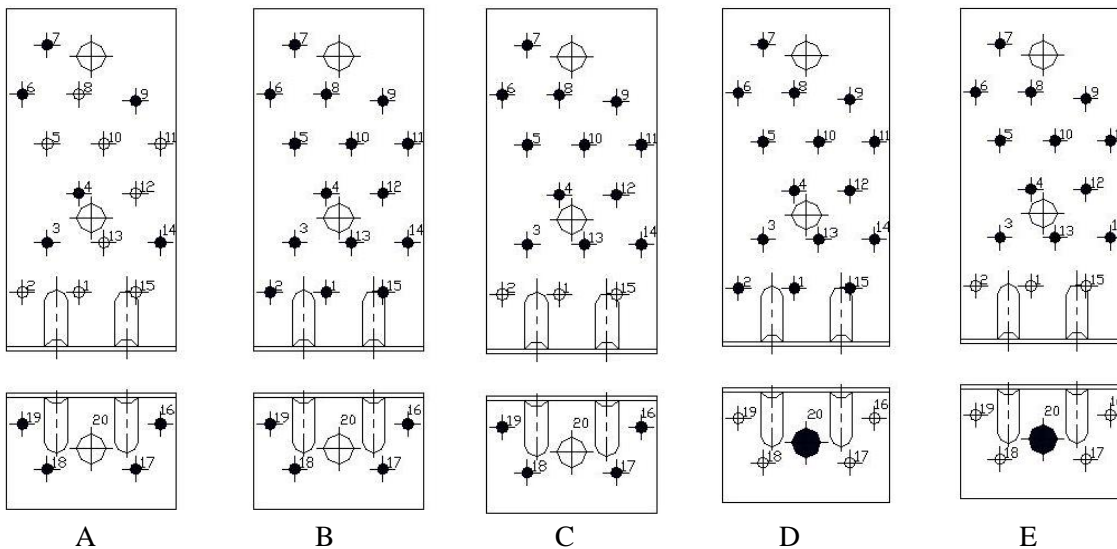

Figure D41-2 : E18/2.5 nails pattern  
 A – Beam to beam connection – Partial nailing  
 B – Beam to beam connection – Full nailing  
 C – Post to beam connection  
 D – Beam to rigid support connection  
 E – Post to rigid connection



**Modified characteristic capacities:**

Table D41-1 E18/2.5 - timber to timber connection – 1 angle bracket

Beam to beam connection				Modified characteristic capacity per connection (kN)				
Load duration	Partial nailing 6+4 (fig. D41-2 A)				Full nailing 15+4 (fig. D41-2 B)			
	R <sub>1,k</sub>		R <sub>2,k</sub> = R <sub>3,k</sub>		R <sub>1,k</sub>		R <sub>2,k</sub> = R <sub>3,k</sub>	
	Connector nail according to ETA-04/0013:				Connector nail according to ETA-04/0013:			
	4,0x35	4,0x60	4,0x35	4,0x60	4,0x35	4,0x60	4,0x35	4,0x60
<b>P</b>	f ≤ 5720,9 20 / (f + 39)	f ≤ 52,3 40 / (f + 39)	1,5	2,7	f ≤ 5721 20 / (f + 39)	f ≤ 52,3 40 / (f + 39)	2,4	4,3
	f > 5720,9 20,5 / (f + 1)	f > 52,3 20,5 / (f + 1)			f > 5721 20,5 / (f + 1)	f > 52,3 20,5 / (f + 1)		
<b>L</b>	f ≤ 218 23 / (f + 39)	f ≤ 37 47 / (f + 39)	1,7	3,1	f ≤ 218 23 / (f + 39)	f ≤ 37 47 / (f + 39)	2,8	5
	f > 218 20,5 / (f + 1)	f > 37 20,5 / (f + 1)			f > 218 20,5 / (f + 1)	f > 37 20,5 / (f + 1)		
<b>M</b>	f ≤ 110,5 27 / (f + 39)	f ≤ 28,5 54 / (f + 39)	2	3,5	f ≤ 110,5 27 / (f + 39)	f ≤ 28,5 54 / (f + 39)	3,2	5,8
	f > 110,5 20,5 / (f + 1)	f > 28,5 20,5 / (f + 1)			f > 110,5 20,5 / (f + 1)	f > 28,5 20,5 / (f + 1)		
<b>S</b>	f ≤ 73,7 31 / (f + 39)	f ≤ 23,1 61 / (f + 39)	2,3	3,9	f ≤ 73,7 31 / (f + 39)	f ≤ 23,1 61 / (f + 39)	3,7	6,5
	f > 73,7 20,5 / (f + 1)	f > 23,1 20,5 / (f + 1)			f > 73,7 20,5 / (f + 1)	f > 23,1 20,5 / (f + 1)		
<b>I</b>	f ≤ 44 37 / (f + 39)	f ≤ 16,6 75 / (f + 39)	2,8	4,8	f ≤ 44 37 / (f + 39)	f ≤ 16,6 75 / (f + 39)	4,5	8
	f > 44 20,5 / (f + 1)	f > 16,6 20,5 / (f + 1)			f > 44 20,5 / (f + 1)	f > 16,6 20,5 / (f + 1)		

f in mm

Note: For R<sub>1,k</sub>, if the purlin is prevented from rotation, consider the value as the half of the one given for two brackets

Table D41-2 E18/2.5 - timber to timber connection – 2 angle brackets (partial- / full nailing)

Beam to beam connection - Characteristic capacity per connection (kN)									
Number of fasteners		$R_{1,k}$				$R_{2,k}$			
Joist	Support	4.0x35	4.0x40	4.0x50	4.0x60	4.0x35	4.0x40	4.0x50	4.0x60
		4,1	4,8	7,5	8,3	5,0	5,4	8,2	8,9
2 x 15 nails	2 x 4 nails	4,88	5,62	6,66	7,38	8,2	8,9	10,8	11,6

Connector nail according to ETA-04/0013

Table D41-3

E18/2.5 - Post to beam connection

Column to beam connection Nailing 12+4 (fig. D41-2 C)				Modified characteristic capacity per connection (kN)				
Load duration	1 Angle Bracket per connection				2 Angle Brackets per connection			
	$R_{1,k}$		$R_{2,k} = R_{3,k}$		$R_{1,k}$		$R_{2,k} = R_{3,k}$	
	Connector nail according to ETA-04/0013:				Connector nail according to ETA-04/0013:			
	4,0x35	4,0x60	4,0x35	4,0x60	4,0x35	4,0x60	4,0x35	4,0x60
<b>P</b>	$f \leq 235,5$ $20 / (f + 39)$	$f \leq 37,9$ $40 / (f + 39)$	2	3,6	2,5	5,0	4,1	7,1
	$f > 235,5$ $17 / (f + 1)$	$f > 37,9$ $17 / (f + 1)$						
<b>L</b>	$f \leq 106,5$ $23 / (f + 39)$	$f \leq 28$ $47 / (f + 39)$	2,4	4,1	2,9	5,8	4,8	8,3
	$f > 106,5$ $17 / (f + 1)$	$f > 28$ $17 / (f + 1)$						
<b>M</b>	$f \leq 68,5$ $27 / (f + 39)$	$f \leq 22,1$ $54 / (f + 39)$	2,8	4,7	3,3	6,7	5,5	9,5
	$f > 68,5$ $17 / (f + 1)$	$f > 22,1$ $17 / (f + 1)$						
<b>S</b>	$f \leq 50,3$ $31 / (f + 39)$	$f \leq 18,2$ $61 / (f + 39)$	3,1	5,4	3,7	7,6	6,2	10,7
	$f > 50,3$ $17 / (f + 1)$	$f > 18,2$ $17 / (f + 1)$						
<b>I</b>	$f \leq 32,6$ $37 / (f + 39)$	$f \leq 13,3$ $75 / (f + 39)$	3,8	6,5	4,5	9,2	7,7	13,0
	$f > 32,6$ $17 / (f + 1)$	$f > 13,3$ $17 / (f + 1)$						

f in mm

**Note:** For  $R_{1,k}$  for 1 angle bracket connection, if the purlin or column is prevented from rotation, consider the value as the half of the one given for two brackets.

Table D41-4 E18/2.5 – beam to rigid support connection (1 angle bracket / 2 angle bracket per connection)

Beam to rigid support connection - Characteristic capacity per connection (kN)									
Number of fasteners		$R_{1,k}$				$R_{2,k}$			
Joist	Support	4.0x35	4.0x40	4.0x50	4.0x60	4.0x35	4.0x40	4.0x50	4.0x60
1 x 15 nails	1 x 1 bolt $\varnothing 10$	min of: $56,6/((f+18) \times k_{mod})$ ; $17/(f \times k_{mod})$				3,0	3,5	5,6	6,3
2 x 15 nails	2 x 1 bolt $\varnothing 10$	20,5	20,5	20,5	20,5	8,1	9,3	11,6	13,1

f in mm

Note: For  $R_{1,k}$  for 1 angle bracket connection, if the purlin or column is prevented from rotation, consider the value as the half of the one given for two brackets.

E18/2,5	connection with 1 angle brackets			
factor:	for $F_1$	for $F_{2/3}$	for $F_4$	for $F_5$
$k_{ax}$	$(f+33,5)/9$	1,82	-	-
$k_{lat}$	-	1,00	-	-

E18/2,5	connection with 2 angle brackets			
factor:	for $F_1$	for $F_{2/3}$	for $F_{4/5}$ , bolt 1	for $F_{4/5}$ , bolt 2
$k_{ax}$	0,98	0,91	-	-
$k_{lat}$	-	0,50	-	-

For each bolt it's needed to check:  $R_{bolt,d,lateral} \geq k_{lat} \times F_{i,d}$  ;  $R_{bolt,d,axial} \geq k_{ax} \times F_{i,d}$  ; and also the combination

Table D41-5 E18/2.5 – Post to rigid support connection

Column to rigid support connection Nailing 12+1 bolt (fig. D41-2 E)				Modified characteristic capacity per connection (kN)					
Load duration	1 angle bracket per connection			2 angle brackets per connection					
	R <sub>1,k</sub>		R <sub>2,k</sub> = R <sub>3,k</sub>	R <sub>1,k</sub>		R <sub>2,k</sub> = R <sub>3,k</sub>			
	Connector nail according to ETA-04/0013: 4,0x35   4,0x60			Connector nail according to ETA-04/0013: 4,0x35   4,0x60   4,0x35   4,0x60					
<b>P</b>	min of :  56,5 / ( f + 18 )  17,7 / f			1,0	2,0	6,0	11,4	2,0	4,2
<b>L</b>				1,1	2,4	7,0	13,4	2,3	4,9
<b>M</b>				1,3	2,8	8,0	15,4	2,7	5,6
<b>S</b>				1,5	3,1	9,0	17,3	3,1	6,3
<b>I</b>				1,8	3,8	11,0	19,3	3,7	7,7

f in mm

Note: For R<sub>1,k</sub> for 1 angle bracket connection, if the purlin or column is prevented from rotation, consider the value as the half of the one given for two brackets.

Requirement for the bolts – see declaration under table D41-4

**Annex D42 – E19/3**

**Product Name:**

Product Name	Alternative name			
	UK	France	Denmark	Germany
E19/3	--	--	--	--

**Drawing:**

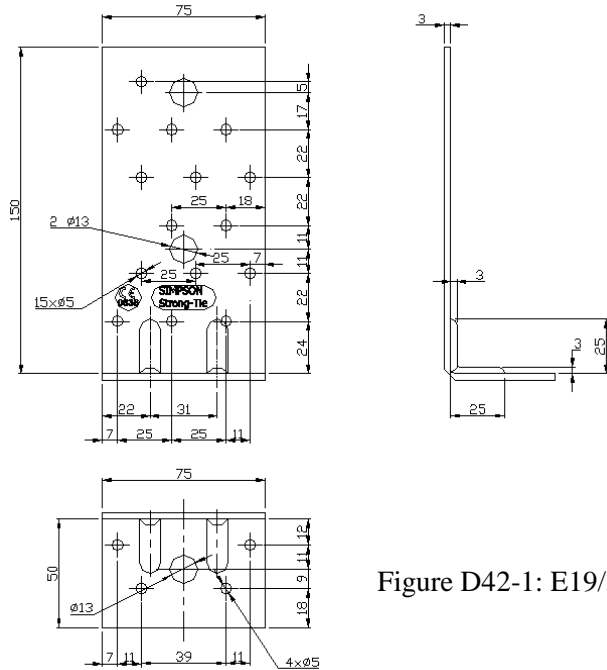

Figure D42-1: E19/3

**Material:**

Standard material : S250GD + Z275 according to EN 10346  
 Or stainless steel according to clause II-1

**Nail pattern:**

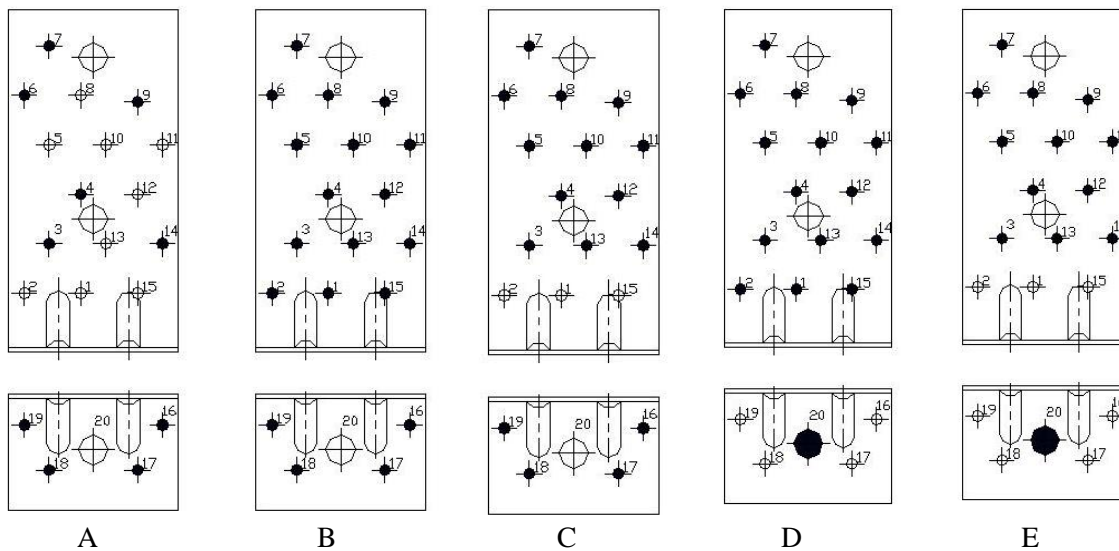

Figure D42-2 : E19/3 nails pattern  
 A – Beam to beam connection – Partial nailing  
 B – Beam to beam connection – Full nailing  
 C – Post to beam connection  
 D – Beam to rigid support connection  
 E – Post to rigid connection

**Modified characteristic capacities:**

Table D42-1 E19/3 - timber to timber connection – 1 bracket

Beam to beam connection				Modified characteristic capacity per connection (kN)				
Load duration	Partial nailing 6+4 (fig. D42-2 A)				Full nailing 15+4 (fig. D42-2 B)			
	R <sub>1,k</sub>		R <sub>2,k</sub> = R <sub>3,k</sub>		R <sub>1,k</sub>		R <sub>2,k</sub> = R <sub>3,k</sub>	
	Connector nail according to ETA-04/0013:				Connector nail according to ETA-04/0013:			
	4,0x35	4,0x60	4,0x35	4,0x60	4,0x35	4,0x60	4,0x35	4,0x60
<b>P</b>	20 / (f + 40)	f ≤ 200,6 41 / (f + 40)	1,5	2,6	20 / (f + 40)	f ≤ 200,6 41 / (f + 40)	2,4	4,3
		f > 200,6 34,6 / (f + 2)				f > 200,6 34,6 / (f + 2)		
<b>L</b>	23 / (f + 40)	f ≤ 97,5 47 / (f + 40)	1,7	3,0	23 / (f + 40)	f ≤ 97,5 47 / (f + 40)	2,8	5
		f > 97,5 34,6 / (f + 2)				f > 97,5 34,6 / (f + 2)		
<b>M</b>	27 / (f + 40)	f ≤ 64,1 54 / (f + 40)	2	3,5	27 / (f + 40)	f ≤ 64,1 54 / (f + 40)	3,2	5,7
		f > 64,1 34,6 / (f + 2)				f > 64,1 34,6 / (f + 2)		
<b>S</b>	31 / (f + 40)	f ≤ 47,5 61 / (f + 40)	2,3	3,9	31 / (f + 40)	f ≤ 47,5 61 / (f + 40)	3,6	6,4
		f > 47,5 34,6 / (f + 2)				f > 47,5 34,6 / (f + 2)		
<b>I</b>	37 / (f + 40)	f ≤ 31,1 75 / (f + 40)	2,8	4,8	37 / (f + 40)	f ≤ 31,1 75 / (f + 40)	4,4	7,9
		f > 31,1 34,6 / (f + 2)				f > 31,1 34,6 / (f + 2)		

f in mm

Note: For R<sub>1,k</sub>, if the purlin is prevented from rotation, consider the value as the half of the one given for two brackets.

Table D42-2 E19/3 - timber to timber connection – 2 brackets (partial- / full nailing)

Beam to beam connection - Characteristic capacity per connection (kN)									
Number of fasteners		R <sub>1,k</sub>				R <sub>2,k</sub>			
Joist	Support	4.0x35	4.0x40	4.0x50	4.0x60	4.0x35	4.0x40	4.0x50	4.0x60
		4,1	4,8	7,5	8,3	5,0	5,4	8,2	8,9
2 x 15 nails	2 x 4 nails	4,9	5,6	6,7	7,4	8,1	8,8	10,7	11,5

Connector nail according to ETA-04/0013

Table D42-3 E19/3 - Post to beam connection

Column to beam connection Nailing 12+1 bolt (fig. D42-2 E)				Modified characteristic capacity per connection (kN)				
Load duration	1 Angle Bracket per connection			2 Angle Brackets per connection				
	R <sub>1,k</sub>		R <sub>2,k</sub> = R <sub>3,k</sub>		R <sub>1,k</sub>		R <sub>2,k</sub> = R <sub>3,k</sub>	
	Connector nail according to ETA-04/0013:							
	4,0x35	4,0x60	4,0x35	4,0x60	4,0x35	4,0x60	4,0x35	4,0x60
<b>P</b>	20 / ( f + 40 )	f ≤ 101,5 41 / ( f + 40 )	1,9	3,4	2,5	5,0	3,9	6,9
		f > 101,5 25,5 / ( f + 2 )						
<b>L</b>	23 / ( f + 40 )	f ≤ 62,4 47 / ( f + 40 )	2,2	4	2,9	5,8	4,5	8,1
		f > 62,4 25,5 / ( f + 2 )						
<b>M</b>	27 / ( f + 40 )	f ≤ 44,8 54 / ( f + 40 )	2,6	4,6	3,3	6,7	5,1	9,1
		f > 44,8 25,5 / ( f + 2 )						
<b>S</b>	f ≤ 181,9 31 / ( f + 40 )	f ≤ 34,8 61 / ( f + 40 )	2,9	5,2	3,7	7,5	5,8	10,3
	f > 181,9 25,5 / ( f + 2 )	f > 34,8 25,5 / ( f + 2 )						
<b>I</b>	f ≤ 78,9 37 / ( f + 40 )	f ≤ 23,9 75 / ( f + 40 )	3,5	6,3	4,5	9,2	7,1	12,7
	f > 78,9 25,5 / ( f + 2 )	f > 23,9 25,5 / ( f + 2 )						

f in mm

**Note:** For R<sub>1,k</sub> for 1 angle bracket connection, if the purlin or column is prevented from rotation, consider the value as the half of the one given for two brackets.

Table D42-4 E19/3 - Beam to rigid support connection (1 angle bracket / 2 angle bracket per connection)

Beam to rigid support connection - Characteristic capacity per connection (kN)									
Number of fasteners		$R_{1,k}$				$R_{2,k}$			
Joist	Support	4.0x35	4.0x40	4.0x50	4.0x60	4.0x35	4.0x40	4.0x50	4.0x60
1 x 15 nails	1 x 1 bolt $\varnothing 10$	min of: $65,6/((f+18) \times k_{mod})$ ; $25,5/(f \times k_{mod})$				3,0	3,4	5,5	6,2
2 x 15 nails	2 x 1 bolt $\varnothing 10$	28,1	28,1	28,1	28,1	8,1	9,2	11,6	13,0

f in mm

Note: For  $R_{1,k}$  for 1 angle bracket connection, if the purlin or column is prevented from rotation, consider the value as the half of the one given for two brackets.

E19/3	connection with 1 angle brackets			
factor:	for $F_1$	for $F_{2/3}$	for $F_4$	for $F_5$
$k_{ax}$	$(f+34)/9$	1,82	-	-
$k_{lat}$	-	1,00	-	-

E19/3	connection with 2 angle brackets			
factor:	for $F_1$	for $F_{2/3}$	for $F_{4/5}$ , bolt 1	for $F_{4/5}$ , bolt 2
$k_{ax}$	0,99	0,91	-	-
$k_{lat}$	-	0,50	-	-

For each bolt it's needed to check:  $R_{bolt,d,lateral} \geq k_{lat} \times F_{i,d}$  ;  $R_{bolt,d,axial} \geq k_{ax} \times F_{i,d}$  ; and also the combination



Table D42-5 E19/3 – Post to rigid support connection

Column to rigid support connection Nailing 12+1 bolt (fig. D42-2 E)					Modified characteristic capacity per connection (kN)			
Load duration	1 angle bracket per connection				2 angle brackets per connection			
	R <sub>1,k</sub>		R <sub>2,k</sub> = R <sub>3,k</sub>		R <sub>1,k</sub>		R <sub>2,k</sub> = R <sub>3,k</sub>	
	Connector nail according to ETA-04/0013:				Connector nail according to ETA-04/0013:			
	4,0x35	4,0x60	4,0x35	4,0x60	4,0x35	4,0x60	4,0x35	4,0x60
<b>P</b>	min of : 17,6 / f 65,6/(f+18)	min of : 65,6/( f+18 ) 25,5 / f	1,7	3,2	6,0	11,5	3,5	6,4
<b>L</b>	min of : 20,6 / f 65,6/(f+18)		2,0	3,7	7,0	13,4	4,1	7,5
<b>M</b>	min of : 23,6 / f 65,6/(f+18)		2,3	4,3	8,0	15,4	4,7	8,6
<b>S</b>	min of : 25,5 / f 65,6/(f+18)		2,6	4,8	9,0	17,3	5,3	9,7
<b>I</b>	min of : 25,5 / f 65,6/(f+18)		3,2	5,9	11,0	19,1	6,5	11,8

f in mm

Note: For R<sub>1,k</sub> for 1 angle bracket connection, if the purlin or column is prevented from rotation, consider the value as the half of the one given for two brackets.

Requirement for the bolts – see declaration under table D42-4

**Annex D43 – ADR6090**

Product Name

Product Name	Alternative name			
	UK	France	Denmark	Germany
ADR6090	--	--	--	--

**Drawing:**

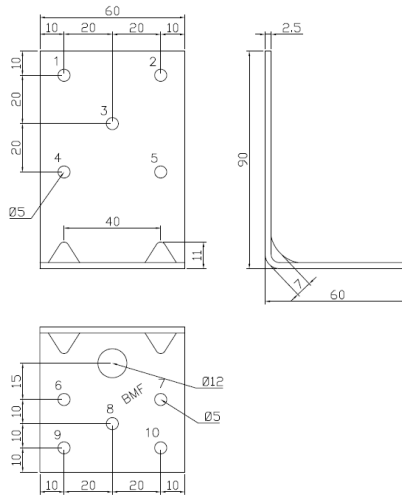

Figure D43-1: ADR6090

**Material:**

Standard material: S250GD + Z275 according to EN 10346

Or stainless steel according to clause II-1

**Nail pattern:**

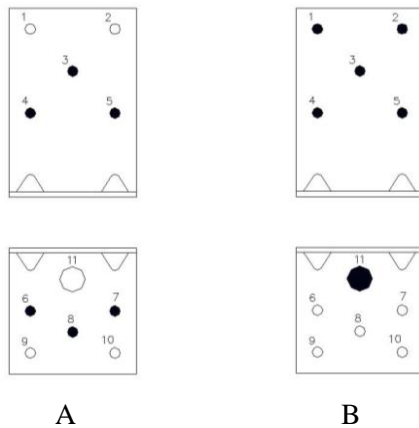

Figure D43-2: ADR6090 nail pattern  
 A – Beam to beam connection  
 B – Beam to rigid support connection

**Modified characteristic capacities:**

Table D43-1 ADR6090 - timber to timber connection

Beam to beam connection Nailing 3+3 (fig. D43-2 A)				Modified characteristic capacity per connection (kN)				
Load duration	1 angle bracket per connection			2 angle brackets per connection				
	R <sub>1,k</sub>		R <sub>2,k</sub> = R <sub>3,k</sub>		R <sub>1,k</sub>		R <sub>2,k</sub> = R <sub>3,k</sub>	
	Connector nail according to ETA-04/0013:				Connector nail according to ETA-04/0013:			
	4,0x40	4,0x60	4,0x40	4,0x60	4,0x40	4,0x60	4,0x40	4,0x60
<b>P</b>	23 / ( f + 28 ) max 20 / ( f + 50 )	23 / ( f + 28 ) max 32 / ( f + 50 )	/	/	1,8	2,7	/	/
<b>L</b>	23 / ( f + 28 ) max 22 / ( f + 50 )	23 / ( f + 28 ) max 37 / ( f + 50 )	/	/	2,0	3,0	/	/
<b>M</b>	23 / ( f + 28 ) max 26 / ( f + 50 )	23 / ( f + 28 )	/	/	2,3	3,2	/	/
<b>S</b>	23 / ( f + 28 ) max 29 / ( f + 50 )	23 / ( f + 28 )	/	/	2,6	3,4	/	/
<b>I</b>	23 / ( f + 28 ) max 35 / ( f + 50 )	23 / ( f + 28 )	/	/	2,9	3,8	/	/

f in mm

Table D43-2 ADR6090 - beam to rigid support connection – 1 and 2 angle bracket

Beam to rigid support connection Nailing 5+1 bolt (fig(D43-2B))	characteristic capacity per connection (kN)	
	1 angle bracket per connection	2 angle bracket per connection
	$R_{1,k}$	$R_{1,k}$
Fastened on a	CNA4,0 x 40 and 4,0x60	CNA4,0 x 40 and 4,0x60
concrete structure	min of: $86,5 / ((f+22) \times k_{mod})$ $35 / ((f+8) \times k_{mod})$ 8,9	min of: 15,7 $9,9 / k_{mod}$
Leigth weight concrete or masonry structure	min of: $75 / ((f+22) \times k_{mod})$ $35 / ((f+8) \times k_{mod})$ 8,3	min of: 14,5 $9,1 / k_{mod}$
<b>for bolt: factor <math>k_{ax}</math></b>	$(f+23) / 10$	0,92

f in mm

For each bolt it's needed to check:  $R_{bolt,d,axial} \geq k_{ax} \times F_{i,d}$

**Annex D44 – ADR6035**

**Product Name:**

Product Name	Alternative name			
	UK	France	Denmark	Germany
ADR6035	--	--	--	--

**Drawing:**

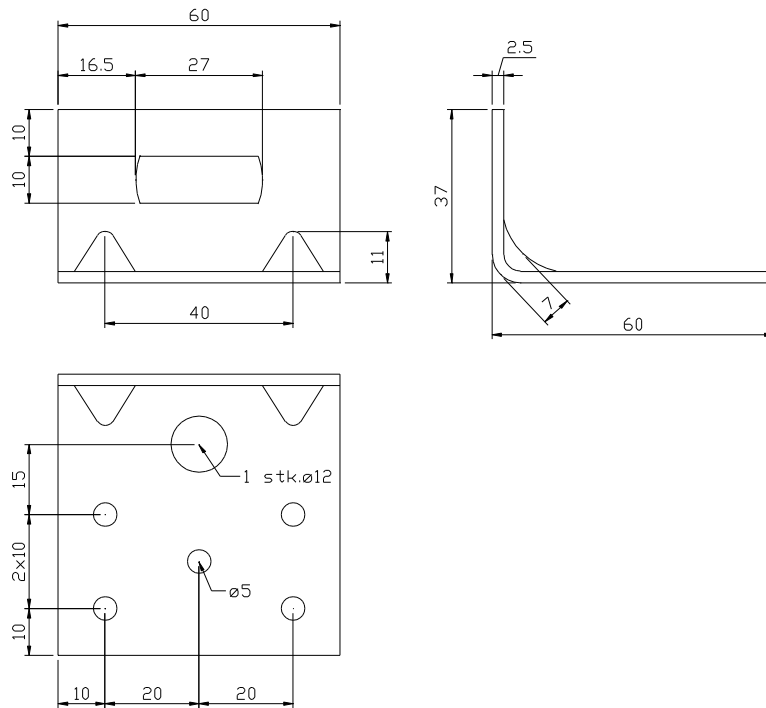

Figure D44-1: ADR6035

**Material:**

Standard material : S250GD + Z275 according to EN 10346

Or stainless steel according to clause II-1

**Nail pattern:**

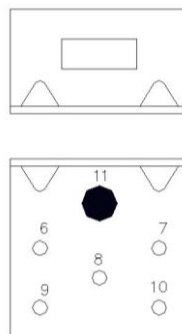

Figure D44-2 : ADR6090 nail pattern

**Characteristic capacities:**

*Table D44-1 ADR6035 – steel strap to rigid support connection*

Steel strap to rigid support connection	Modified characteristic capacity per connection (kN)
	1 angle bracket per connection
	$R_{1,k}$
Fastened on a concrete structure	CNA4,0 x 40 and 4,0x60 5,2 / $k_{mod}$
Leigth weight concrete or masonry structure	4,0 / $k_{mod}$
<b>for bolt: factor <math>k_{ax}</math></b>	2,2

For each bolt it's needed to check:  $R_{bolt,d,axial} \geq k_{ax} \times F_{i,d}$

**Annex D45 – ABAI105**

**Product Name:**

Product Name	Alternative name			
	UK	France	Denmark	Germany
ABAI105	--	--	--	--

**Drawing:**

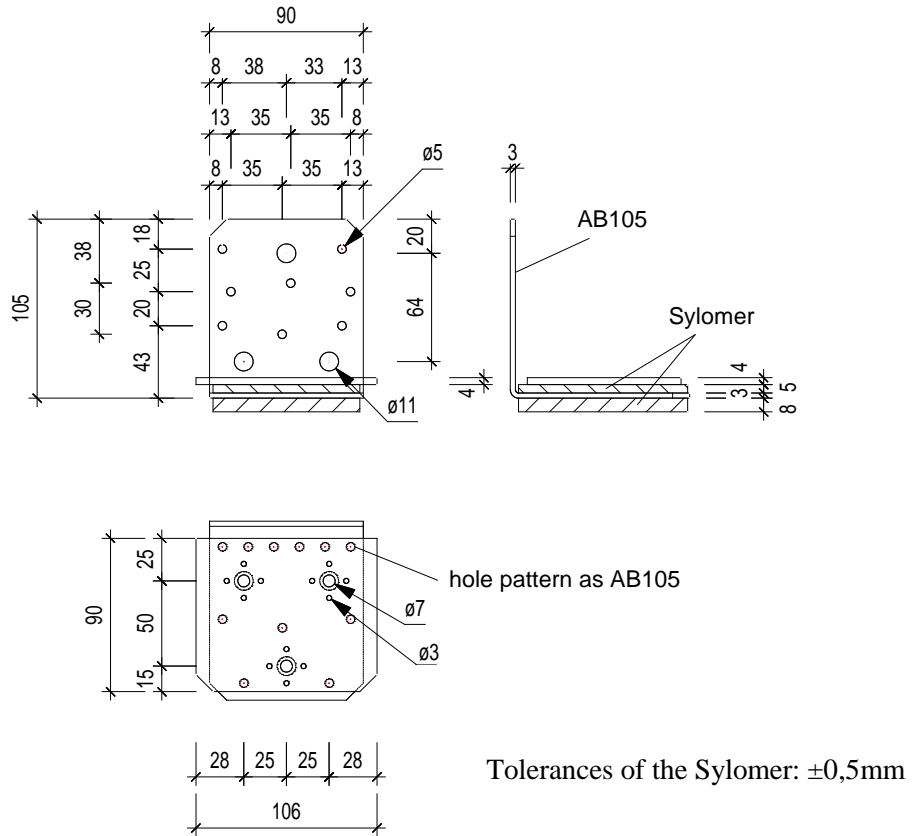

Figure D45-1: ABAI105

**Material:**

S250GD + Z275 according to EN 10346

Polyurethane Sylomer SR220

**Nail pattern:**

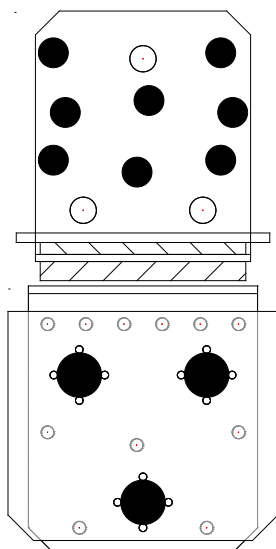

Figure D45-2. ABAI105 nail pattern  
8 x CNA4,0x60 (or CSA5,0x50) to wall  
3 x SDS25600 to floor

**Characteristic capacities:**

Table D45-1 ABAI105 – CLT wall to floor connection; characteristic values

Characteristic capacity of a CLT wall to floor single side connection for one ABAI105				
	R <sub>1,k</sub>	R <sub>2,k</sub> /R <sub>3,k</sub>	R <sub>4,k</sub>	R <sub>5,k</sub>
characteristic value R <sub>k</sub> [kN]	1,4	1,4	3,3	1,6
slip modulus k <sub>s</sub> [kN/mm]	0,8	0,68	1,16	0,8

Table D45-2 ABAI105 – CLT wall to floor connection; ultimate limit state values

Ultimate limit state capacity of a CLT wall to floor single side connection for one ABAI105				
	R <sub>1,u</sub>	R <sub>2,u</sub> /R <sub>3,u</sub>	R <sub>4,u</sub>	R <sub>5,u</sub>
ultimate limit state R <sub>k,u</sub> [kN]	7,9	5,9	7,3	5,4

Ultimate limit state values shall only be used under rare disaster situations, e.g. disproportionate collapse, vehicle impact, etc... To evaluate the connected displacements, the slip modulus from table D45-1 can be used.





**Characteristic capacities:***Table D46-1 AG922 – Beam to beam connection – 2 angle brackets*

<b>2 Angle Brackets AG922</b>		
Beam to Beam connection		
Characteristic capacity for two AG922		
16 Ø4,0x50 nails in the vertical flange / 13 Ø4,0x50 nails in the horizontal flange		
	R <sub>1,k</sub>	R <sub>2,k</sub> /R <sub>3,k</sub>
characteristic value R <sub>k</sub> [kN]	18,5	29,5

*Table D46-2 AG922 – Beam to rigid support connection – 2 angle brackets*

<b>2 Angle Brackets AG922</b>		
Beam to rigid support connection		
Characteristic capacity for two A922 [kN]		
16 CNA nails in the vertical flange / 2 anchor bolts Ø12 in the horizontal flange		
fastener	R <sub>1,k</sub>	R <sub>2,k</sub> /R <sub>3,k</sub>
CNA4,0x35	-	41,9
CNA4,0x50	30,6	48,2

*Table D46-3 AG922 – Post to beam connection – 2 angle brackets*

<b>2 Angle Brackets AG922</b>		
Post to beam connection		
Characteristic capacity for two AG922		
12 Ø4,0x50 nails in the vertical flange / 13 Ø4,0x50 nails in the horizontal flange		
	R <sub>1,k</sub>	R <sub>2,k</sub> /R <sub>3,k</sub>
characteristic value R <sub>k</sub> [kN]	18,5	--

*Table D46-4 AG922 – Post to rigid support connection – 2 angle brackets*

<b>2 Angle Brackets AG922</b>		
Post to rigid support connection		
Characteristic capacity for two AG922		
12 Ø4,0x50 nails in the vertical flange / 2 anchor bolts Ø12 in the horizontal flange		
	R <sub>1,k</sub>	R <sub>2,k</sub> /R <sub>3,k</sub>
characteristic value R <sub>k</sub> [kN]	37,5	--

Table D46-5 AG922 – Beam to post connection – 1 angle bracket

<b>1 Angle Bracket AG922</b>	
Beam to post connection	
Characteristic capacity for one AG922	
12 Ø4,0x50 nails in the longest flange / 13 Ø4,0x50 nails in the shortest flange Nail pattern according to figure D46-2 C	
	$R_{1,k}$
characteristic value $R_k$ [kN]	22,6

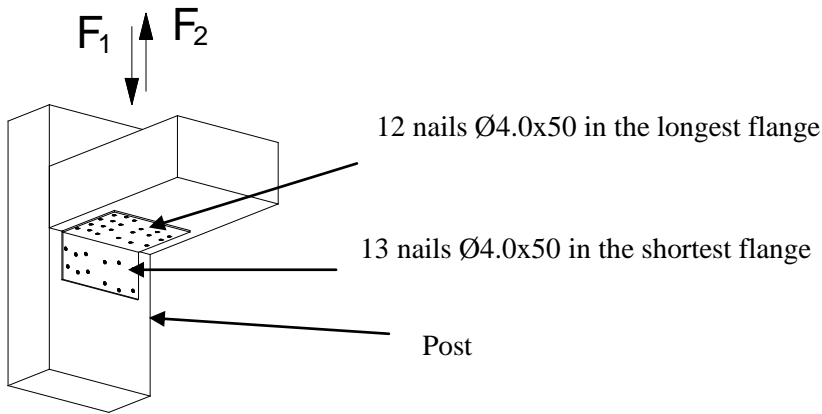
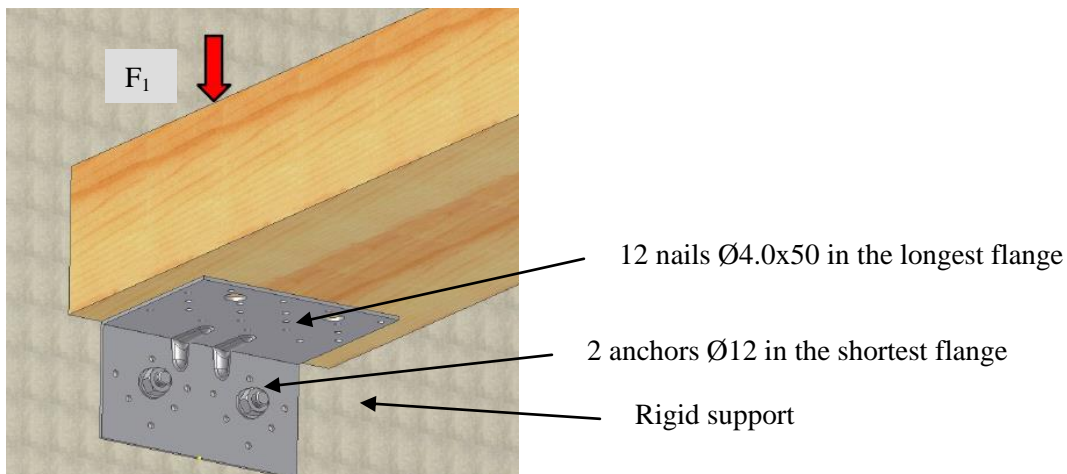

Table D46-6 AG922 – Beam to rigid support connection – 1 angle bracket

<b>1 Angle Bracket AG922</b>	
Beam to rigid support connection	
Characteristic capacity for one AG922	
12 Ø4,0x50 nails in the vertical flange / 2 anchor bolts Ø12 in the horizontal flange Nail pattern according to figure D46-2 D	
	$R_{1,k}$
characteristic value $R_k$ [kN]	24,8



To table D46-2:

The bolt group must be able to resist to

$$F_{2,d} \text{ [kN]}$$

$$M_{x,F2,d} = F_{2,d} \times 27 \text{ mm [kNm]}$$

$$M_{y,F2,d} = F_{2,d} \times 70 \text{ mm [kNm]}$$

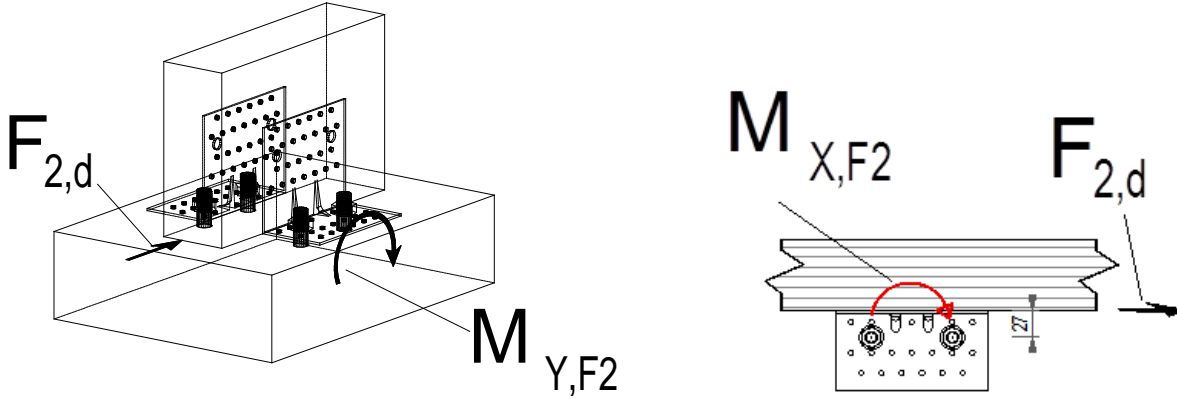

To table D46-2, D46-4, D46-6

<b>AG922</b>	connection with 2 angle brackets		connection with 1 angle brackets
factor:	for $F_1$	for $F_{2/3}$	for $F_1$ (to table D46-6)
$k_{ax}$	0,75	-	1
$k_{lat}$	-	See description	1

For each bolt-pair it's needed to check:  $R_{bolt,d,lateral} \geq k_{lat} \times F_{i,d}$  ;  $R_{bolt,d,axial} \geq k_{ax} \times F_{i,d}$  ; and also the combination

**Annex D47 – ABR10525**

**Product Name:**

Product Name	Alternative name			
	UK	France	Denmark	Germany
ABR10525	--	--	--	--
ABR10525S	--	--	--	--
ABR10525S2	--	--	--	--

**Drawing:**

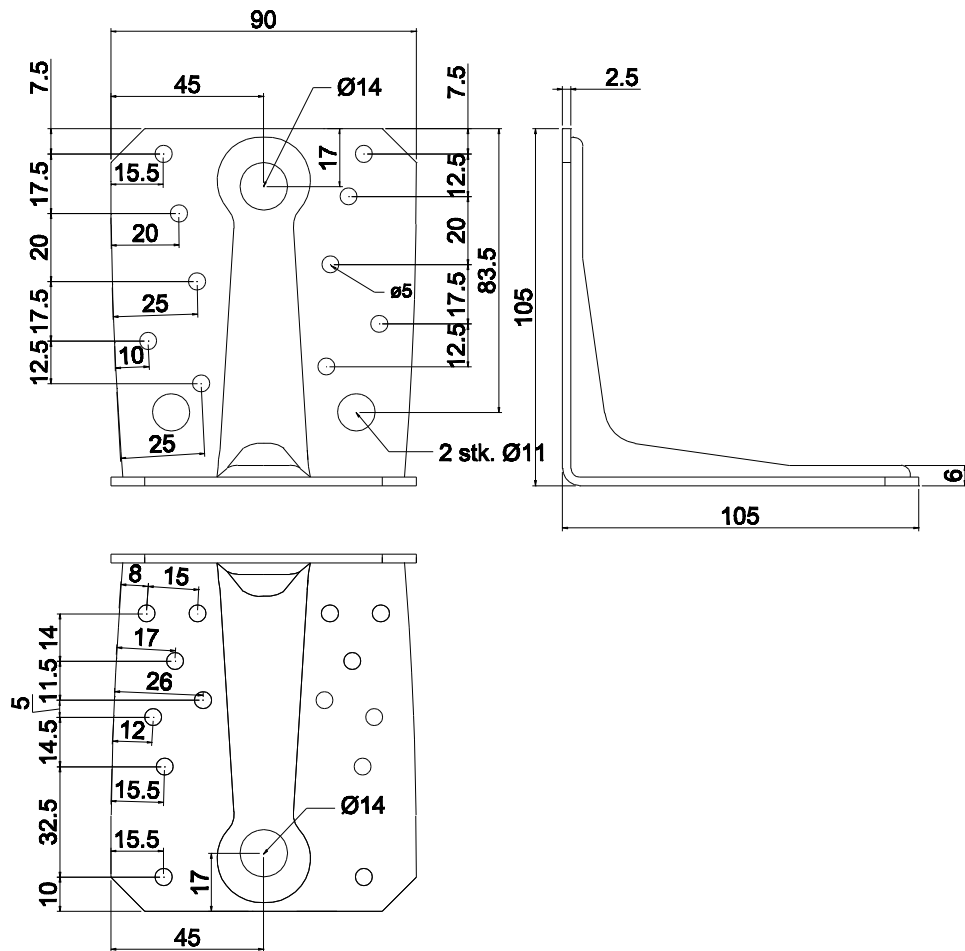

Figure D47-1: ABR10525

**Material:**

Standard material: S350GD + Z275 according to EN 10346

Or stainless steel according to clause II-1

**Nail pattern:**

Beam to beam connection

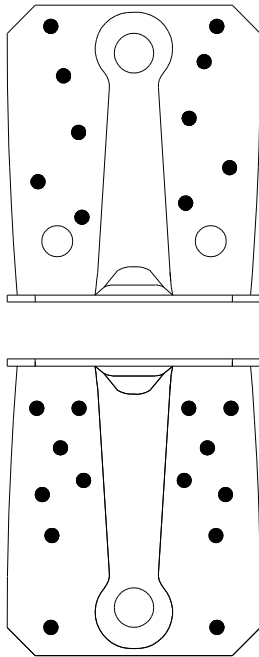

Figure D47-2  
10 nails in vertical flap  
14 nails in horizontal flap

Beam to steel (6 mm S355) connection

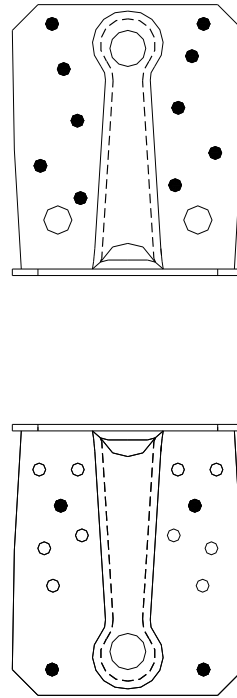

Figure D47-4  
10 CNA4,0x60 nails in vertical flap  
4 PDPA-75 nails in the horizontal flap

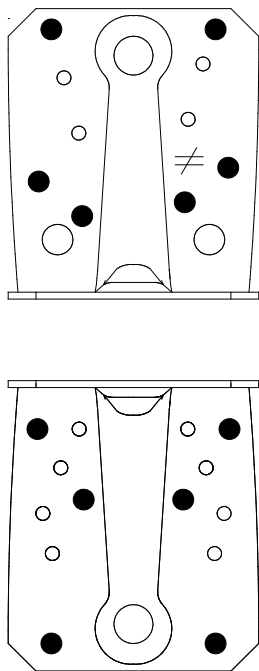

Figure D47-3  
6 nails in vertical flap  
6 nails in horizontal flap

beam to column

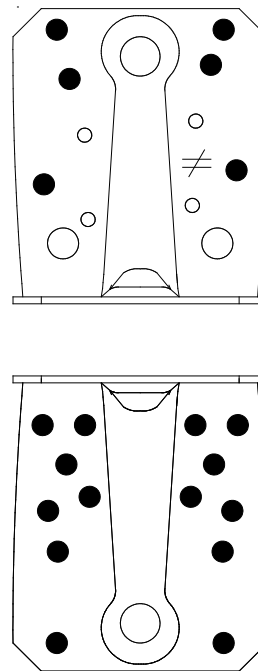

Figure D47-5  
14 nails in vertical flap  
6 nails in the horizontal flap

**Modified characteristic capacities:**

Table D47-1 ABR10525 – Beam to beam connection – 2 angle brackets

2 ABR10525 per connection		Modified characteristic capacity per connection (kN)								
Nailing	Load duration	R <sub>1,k</sub>			R <sub>2,k</sub> = R <sub>3,k</sub>			R <sub>4,k</sub> = R <sub>5,k</sub>		
		Connector nail according to ETA-04/0013								
		4,0x35	4,0x40	4,0x60	4,0x35	4,0x40	4,0x60	4,0x35	4,0x40	4,0x60
<b>Maximum Nailing 10+14</b>  See fig. D47-2	P	7,6	10,3	17,7	6,4	7,3	11,8	$\frac{6,8 \cdot b + 903}{e}$ max 7,1	$\frac{7,2 \cdot b + 901}{e}$ max 8,2	$\frac{8,6 \cdot b + 894}{e}$ max 12,2
	L	8,9	12,0	20,6	7,5	8,5	13,8	$\frac{7,1 \cdot b + 901}{e}$ max 8,0	$\frac{7,5 \cdot b + 899}{e}$ max 9,2	$\frac{9,1 \cdot b + 891}{e}$ max 13,9
	M	10,2	13,8	23,6	8,6	9,7	15,8	$\frac{7,4 \cdot b + 900}{e}$ max 8,8	$\frac{7,9 \cdot b + 898}{e}$ max 7,9	$\frac{9,7 \cdot b + 888}{e}$ max 15,6
	S	11,4	15,5	26,5	9,7	10,9	17,7	$\frac{7,7 \cdot b + 898}{e}$ max 9,7	$\frac{8,2 \cdot b + 896}{e}$ max 11,2	$\frac{10,3 \cdot b + 885}{e}$ max 17,4
	I	14,0	18,9	32,4	11,8	13,4	21,7	$\frac{8,3 \cdot b + 895}{e}$ max 11,4	$\frac{8,9 \cdot b + 892}{e}$ max 13,3	$\frac{11,5 \cdot b + 879}{e}$ max 20,8

b and e are in mm.

Table D47-2 ABR10525 – Beam to beam connection – 1 angle bracket

1 Angle Bracket ABR10525 per connection		Modified characteristic capacity per connection (kN)														
Nailing	Load duration	R <sub>1,k</sub>			R <sub>2,k</sub> = R <sub>3,k</sub>			R <sub>4,k</sub>			R <sub>5,k</sub>					
		Connector nail according to ETA-04/0013:						4,0x35	4,0x40	4,0x60	4,0x35	4,0x40	4,0x60			
Maximum nailing: 8+10  See fig. D47-2	P	f≤ 25: <u>221</u> f+75	f≤ 27: <u>249</u> f+75	f≤ 33: <u>358</u> f+75	3,2	3,6	5,9	e≤ 26: 8,0	e≤ 25: 8,8	e≤ 22: 11,3	e≤ 60:	e≤ 58:	e≤ 55:			
								26<e≤ 115: <u>211</u> e	25<e≤ 123: <u>220</u> e	22<e≤ 156: <u>254</u> e	60<e≤ 2,40-b-32: <u>64</u> 83-e	58<e≤ 2,24-b-27: <u>77</u> 83-e	55<e≤ 1,84-b-15: <u>129</u> 83-e			
		f>25: <u>55</u> f	f>27: <u>66</u> f	f>33: <u>110</u> f							e>115: <u>60</u> e-82,5	e>123: <u>72</u> e-82,5	e>156: <u>120</u> e-82,5	e>2,40-b-32: <u>2,8</u>	e>2,24-b-27: <u>3,2</u>	e>1,84-b-15: <u>4,7</u>
														e>2,40-b-32: <u>6,8-b-323</u> e-83	e>2,24-b-27: <u>7,2-b-349</u> e-83	e>1,84-b-15: <u>8,6-b-454</u> e-83
	L	f≤ 27: <u>244</u> f+75	f≤ 29: <u>276</u> f+75	f≤ 35: <u>404</u> f+75	3,8	4,3	6,9	e≤ 23: 9,4	e≤ 22: 10,3	e≤ 20: 13,2	e≤ 59:	e≤ 57:	e≤ 54:			
								23<e≤ 121: <u>218</u> e	22<e≤ 130: <u>228</u> e	20<e≤ 172: <u>268</u> e	59<e≤ 2,26-b-30: <u>75</u> 83-e	57<e≤ 2,11-b-26: <u>90</u> 83-e	54<e≤ 1,74-b-14: <u>150</u> 83-e			
		f>27: <u>64</u> f	f>29: <u>77</u> f	f>35: <u>129</u> f							e>121: <u>70</u> e-82,5	e>130: <u>84</u> e-82,5	e>172: <u>140</u> e-82,5	e>2,26-b-30: <u>3,1</u>	e>2,11-b-26: <u>3,6</u>	e>1,74-b-14: <u>5,3</u>
														e>2,26-b-30: <u>7,1-b-345</u> e-83	e>2,11-b-26: <u>7,5-b-375</u> e-83	e>1,74-b-14: <u>9,1-b-497</u> e-83
	M	f≤ 29: <u>267</u> f+75	f≤ 31: <u>303</u> f+75	f≤ 36: <u>450</u> f+75	4,3	4,9	7,9	e≤ 21: 10,7	e≤ 20: 11,7	e≤ 19: 15,1	e≤ 58:	e≤ 56:	e≤ 53:			
								21<e≤ 128: <u>226</u> e	20<e≤ 139: <u>237</u> e	19<e≤ 146: <u>282</u> e	58<e≤ 2,15-b-29: <u>86</u> 83-e	56<e≤ 2,00-b-24: <u>103</u> 83-e	53<e≤ 1,66-b-12: <u>172</u> 83-e			
		f>29: <u>74</u> f	f>31: <u>88</u> f	f>36: <u>147</u> f							e>128: <u>80</u> e-82,5	e>139: <u>96</u> e-82,5	146<e≤ 213: <u>219,8</u> e-32,5	e>2,15-b-29: <u>3,4</u>	e>2,00-b-24: <u>3,9</u>	e>1,66-b-12: <u>5,9</u>
														e>2,15-b-29: <u>7,4-b-367</u> e-83	e>2,00-b-24: <u>7,9-b-401</u> e-83	e>1,66-b-12: <u>9,7-b-541</u> e-83
	S	f≤ 30: <u>290</u> f+75	f≤ 32: <u>331</u> f+75	f≤ 35: <u>496</u> f+75	4,8	5,5	8,9	e≤ 19: 12,1	e≤ 19: 13,2	e≤ 17: 17	e≤ 57:	e≤ 55:	e≤ 53:			
								19<e≤ 135: <u>233</u> e	19<e≤ 147: <u>245</u> e	17<e≤ 125: <u>297</u> e	57<e≤ 2,05-b-28: <u>97</u> 83-e	55<e≤ 1,91-b-23: <u>116</u> 83-e	53<e≤ 1,59-b-11: <u>193</u> 83-e			
f>30: <u>83</u> f		f>32: <u>99</u> f	f>35: <u>159</u> f							e>135: <u>90</u> e-82,5	e>147: <u>108</u> e-82,5	125<e≤ 300: <u>219,8</u> e-32,5	e>2,05-b-28: <u>3,7</u>	e>1,91-b-23: <u>4,3</u>	e>1,59-b-11: <u>6,5</u>	
													e>300: <u>179</u> e-82,5	e>2,05-b-28: <u>7,7-b-388</u> e-83	e>1,91-b-23: <u>8,2-b-428</u> e-83	e>1,59-b-11: <u>10,3-b-585</u> e-83
I	f≤ 32: <u>336</u> f+75	f≤ 34: <u>386</u> f+75	f≤ 28: <u>587</u> f+75	5,9	6,7	10,8	e≤ 17: 14,7	e≤ 16: 16,1	e≤ 16: 20,8	e≤ 55:	e≤ 54:	e≤ 52:				
							17<e≤ 149: <u>247</u> e	16<e≤ 165: <u>263</u> e	16<e≤ 254: <u>325</u> e	55<e≤ 1,90-b-26: <u>118</u> 83-e	54<e≤ 1,78-b-21: <u>141</u> 83-e	52<e≤ 1,49-b-8: <u>236</u> 83-e				
	f>32: <u>101</u> f	f>34: <u>121</u> f	f>28: <u>159</u> f							e>149: <u>110</u> e-82,5	e>165: <u>132</u> e-82,5	e>254: <u>219</u> e-82,5	55<e≤ 1,90-b-26: <u>4,4</u>	54<e≤ 1,78-b-21: <u>5,0</u>	52<e≤ 1,49-b-8: <u>7,7</u>	
													e>1,90-b-26: <u>8,3-b-432</u> e-83	e>1,78-b-21: <u>8,9-b-480</u> e-83	e>1,49-b-8: <u>11,5-b-672</u> e-83	

f, e and b are in mm.



**Characteristic capacities:**

Table D47-3 ABR10525 – Beam to beam connection – 2 angle bracket

2 Angle Brackets ABR10525 nailing	characteristic capacity in [kN]								
	R <sub>1,k</sub>			R <sub>2/3,k</sub>			R <sub>4/5,k</sub>		
	connector nails according ETA-04/0013								
	4,0x35	4,0x40	4,0x60	4,0x35	4,0x40	4,0x60	4,0x35	4,0x40	4,0x60
partial nailing: vertical:6 nails + horizontal 6 nails see fig D47-3	4,80	5,70	9,50	9,7	10,6	14,3	a=6,8	a=7,1	a=8,3
							y=10,1	y=11,7	y=17,8
							$\min \left\{ \begin{array}{l} \left( \frac{a}{k_{mod}^{0,75}} \times b + \frac{902}{k_{mod}} \right) / e \\ \frac{y}{k_{mod}^{0,2}} \end{array} \right.$		

e and f in [mm]; b = the width of the timber in [mm]

Table D47-4 ABR10525 – Beam to beam connection – 1 angle bracket

1 Angle Bracket ABR10525 nailing	characteristic capacity in [kN]											
	R <sub>1,k</sub>			R <sub>2/3,k</sub>			R <sub>4,k</sub>			R <sub>5,k</sub>		
	connector nails according ETA-04/0013											
	4,0x35	4,0x40	4,0x60	4,0x35	4,0x40	4,0x60	4,0x35	4,0x40	4,0x60	4,0x35	4,0x40	4,0x60
partial nailing: vertical:6 nails + horizontal 6 nails see fig. D47-3	a=224	a=249	a=350	4,9	5,3	7,2	a=3,4	a=3,7	a=4,7	a=6,9	a=7,2	a=8,3
	y=107	y=129	y=214				y=228	y=238	y=278	y=354	y=384	y=503
							z=100	z=120	z=200	z=3,9	z=4,4	z=6,6
	$\min \left\{ \begin{array}{l} \frac{a}{(f+75) \times k_{mod}^{0,4}} \\ \frac{y}{f} \\ \frac{159}{f \times k_{mod}} \end{array} \right.$						$\min \left\{ \begin{array}{l} \frac{a}{k_{mod}^{0,75} \times e} \\ \frac{z}{e-82,5} \end{array} \right.$			$\min \left\{ \begin{array}{l} \frac{a \times b - y}{k_{mod}^{0,7} \times (e-83)} \\ \frac{z}{k_{mod}^{0,2}} \end{array} \right.$		

e and f in [mm]; b = the width of the timber in [mm]

Table D47-5 2 angle brackets ABR10525, timber beam to 6 mm steel beam connection – connector nails + PAT pins

2 Angle Brackets ABR10525 per connection	Characteristic capacity per connection [kN]
Nailing	R <sub>1,k</sub>
10 CNA4,0x60 + 4 PDPA-75 See fig. D47-4	15,3

Connector nails according to ETA-04/0013

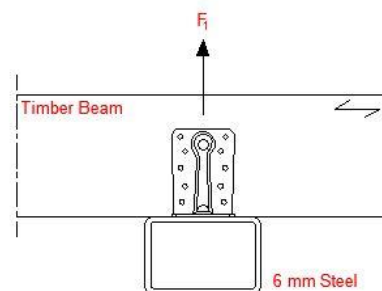
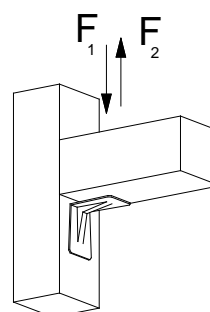

Table D47-6 1 angle brackets ABR10525, beam to column modified characteristic capacity per connection [kN]

	R <sub>1,k</sub>		R <sub>2,k</sub>	
	4,0x40	4,0x60	4,0x40	4,0x60
	Nailing 6+14 see fig. D47-5	13,7	18,3	1,5



**Annex D48 – ABR7015**

**Product Name:**

Product Name	Alternative name			
	UK	France	Denmark	Germany
ABR7015	--	--	--	--
ABR7015S	--	--	--	--
ABR7015S2	--	--	--	--

**Drawing:**

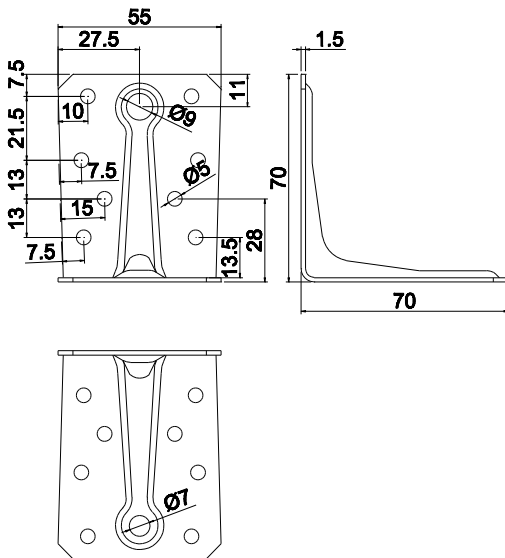

Figure D48-1: ABR7015

**Material:**

Standard material: S350GD + Z275 according to EN 10346

Or stainless steel according to clause II-1

**Nail pattern:**

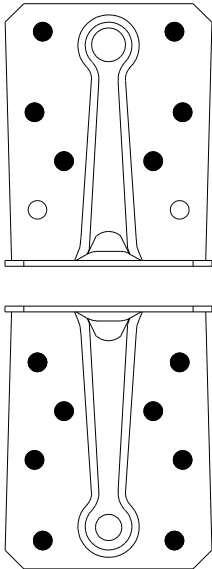

Figure D48-2: ABR7015 nail pattern

**Modified characteristic capacities:**

Table D48-1 ABR7015 – Beam to beam connection – 2 angle brackets

2 ABR7015 per connection		Modified characteristic capacity per connection (kN)					
Nailing	Load duration	$R_{1,k}$		$R_{2,k} = R_{3,k}$		$R_{4,k} = R_{5,k}$	
		Connector nail according to ETA-04/0013					
		4,0x35	4,0x40	4,0x35	4,0x40	4,0x35	4,0x40
Maximum Nailing 6+8  See fig. D48-2	P	3,1	3,7	4,0	4,4	$\frac{1,5 \cdot b + 277}{e}$ max 5,0	$\frac{1,8 \cdot b + 302}{e}$ max 6,0
	L	3,6	4,3	4,7	5,1	$\frac{1,7 \cdot b + 298}{e}$ max 5,8	$\frac{2,1 \cdot b + 327}{e}$ max 7,0
	M	4,2	4,9	5,3	5,9	$\frac{2,0 \cdot b + 319}{e}$ max 6,7	$\frac{2,4 \cdot b + 352}{e}$ max 8,0
	S	4,7	5,5	6,0	6,6	$\frac{2,2 \cdot b + 340}{e}$ max 7,5	$\frac{2,6 \cdot b + 378}{e}$ max 9,0
	I	5,7	6,7	7,3	8,1	$\frac{2,7 \cdot b + 382}{e}$ max 9,2	$\frac{3,2 \cdot b + 428}{e}$ max 11,0

b and e are in mm.

Table D48-2 ABR7015 – Beam to beam connection – 1 angle bracket

1 Angle Bracket ABR7015 per connection		Modified characteristic capacity per connection (kN)							
Nailing	Load duration	R <sub>1,k</sub>		R <sub>2,k</sub> = R <sub>3,k</sub>		R <sub>4,k</sub>		R <sub>5,k</sub>	
		4,0x35	4,0x40	4,0x35	4,0x40	4,0x35	4,0x40	4,0x35	4,0x40
Maximum nailing: 6+8  See fig. D48-2	P	Connector nail according to ETA-04/0013:							
		f ≤ 27: <u>75</u> f+60	f ≤ 29: <u>87</u> f+60	2,0	2,2	e ≤ 6: 6,0	e ≤ 7: 6,6	e ≤ 42: <u>38</u> 60-e	e ≤ 42: <u>45</u> 60-e
		f > 27: <u>24</u> f	f > 29: <u>28</u> f			6 < e ≤ 220: <u>38</u> e	7 < e ≤ 102: <u>46</u> e	42 < e ≤ 0,71·b+21: 2,1	42 < e ≤ 0,71·b+21: 2,5
						e > 220: <u>35</u> e-25	e > 102: <u>35</u> e-25	e > 0,71·b+21: <u>1,47·b-80</u> e-60	e > 0,71·b+21: <u>1,76·b-96</u> e-60
	L	f ≤ 29: <u>85</u> f+60	f ≤ 24: <u>98</u> f+60	2,3	2,6	e ≤ 6: 7,0	e ≤ 7: 7,7	e ≤ 42: <u>44</u> 60-e	e ≤ 42: <u>52</u> 60-e
		f > 29: <u>27</u> f	f > 24: <u>28</u> f			6 < e ≤ 115: <u>44</u> e	7 < e ≤ 71: <u>53</u> e	42 < e ≤ 0,71·b+21: 2,4	42 < e ≤ 0,71·b+21: 2,9
						e > 115: <u>35</u> e-25	e > 71: <u>35</u> e-25	e > 0,71·b+21: <u>1,72·b-94</u> e-60	e > 0,71·b+21: <u>2,06·b-112</u> e-60
	M	f ≤ 25: <u>94</u> f+60	f ≤ 21: <u>110</u> f+60	2,7	2,9	e ≤ 6: 8,0	e ≤ 7: 8,8	e ≤ 42: <u>50</u> 60-e	e ≤ 42: <u>60</u> 60-e
		f > 25: <u>28</u> f	f > 21: <u>28</u> f			6 < e ≤ 80: <u>51</u> e	7 < e ≤ 58: <u>61</u> e	42 < e ≤ 0,71·b+21: 2,7	42 < e ≤ 0,71·b+21: 3,3
						e > 80: <u>35</u> e-25	e > 58: <u>35</u> e-25	e > 0,71·b+21: <u>1,96·b-107</u> e-60	e > 0,71·b+21: <u>2,35·b-128</u> e-60
	S	f ≤ 22: <u>104</u> f+60	f ≤ 18: <u>121</u> f+60	3,0	3,3	e ≤ 6: 9,1	e ≤ 7: 9,9	e ≤ 42: <u>56</u> 60-e	e ≤ 42: <u>67</u> 60-e
		f > 22: <u>28</u> f	f > 18: <u>28</u> f			6 < e ≤ 64: <u>57</u> e	7 < e ≤ 51: <u>68</u> e	42 < e ≤ 0,71·b+21: 3,1	42 < e ≤ 0,71·b+21: 3,7
						e > 64: <u>35</u> e-25	e > 51: <u>35</u> e-25	e > 0,71·b+21: <u>2,21·b-120</u> e-60	e > 0,71·b+21: <u>2,65·b-144</u> e-60
I	f ≤ 18: <u>123</u> f+60	f ≤ 15: <u>144</u> f+60	3,7	4,0	e ≤ 6: 11,1	e ≤ 6: 12,1	e ≤ 42: <u>69</u> 60-e	e ≤ 42: <u>82</u> 60-e	
	f > 18: <u>28</u> f	f > 15: <u>28</u> f			6 < e ≤ 50: <u>70</u> e	6 < e ≤ 48: <u>73</u> e	42 < e ≤ 0,71·b+21: 3,8	42 < e ≤ 0,71·b+21: 4,5	
					e > 50: <u>35</u> e-25	e > 48: <u>35</u> e-25	e > 0,71·b+21: <u>2,70·b-147</u> e-60	e > 0,71·b+21: <u>3,23·b-176</u> e-60	

f, e and b are in mm.

**Annex D49 – ACR / ACRL****Product Name:**

Product Name	Alternative name			
	UK	France	Denmark	Germany
ACR7010	--	--	--	--
ACR7012	--	--	--	--
ACR7015	--	--	--	--
ACR9012	--	--	--	--
ACR9015	--	--	--	--
ACR9020	--	--	--	--
ACR10512	--	--	--	--
ACR10515	--	--	--	--
ACR10520	--	--	--	--
ACRL10520	--	--	--	--

Added to the name a "S" : the product are produced in stainless steel with over 2% Mo (acid resisting)

Added to the name a "S2": the product are produced in stainless steel with less than 2% Mo

**Drawing:**

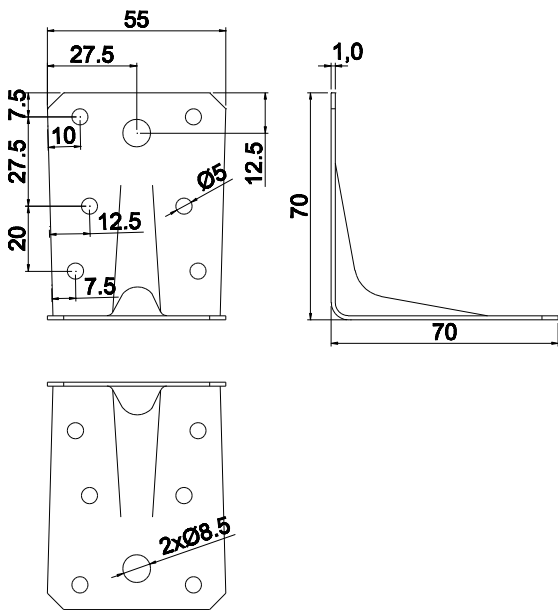

Figure D49-1: ACR7010

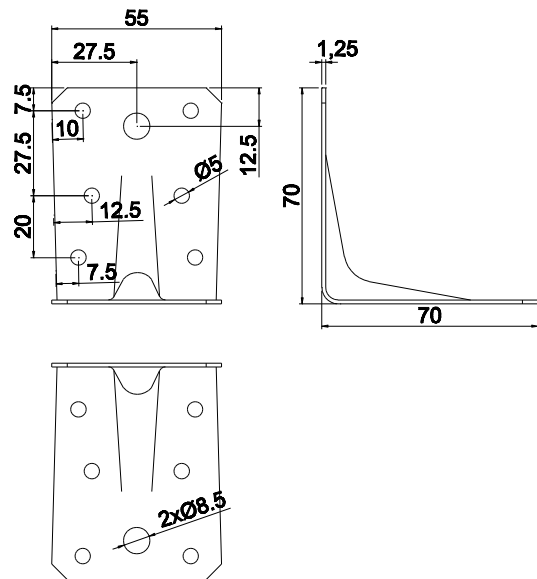

Figure D49-2: ACR7012

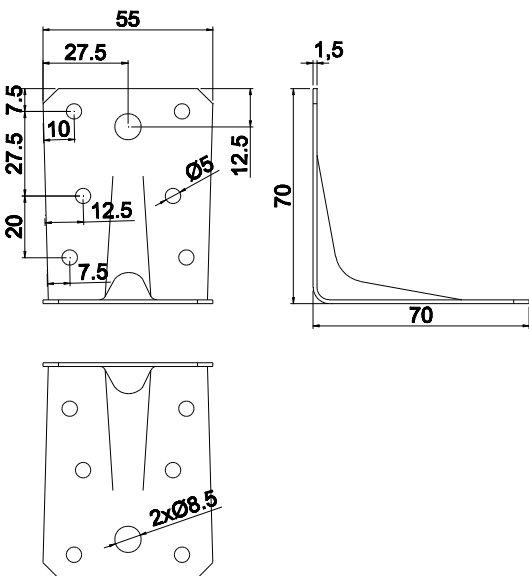

Figure D49-3: ACR7015

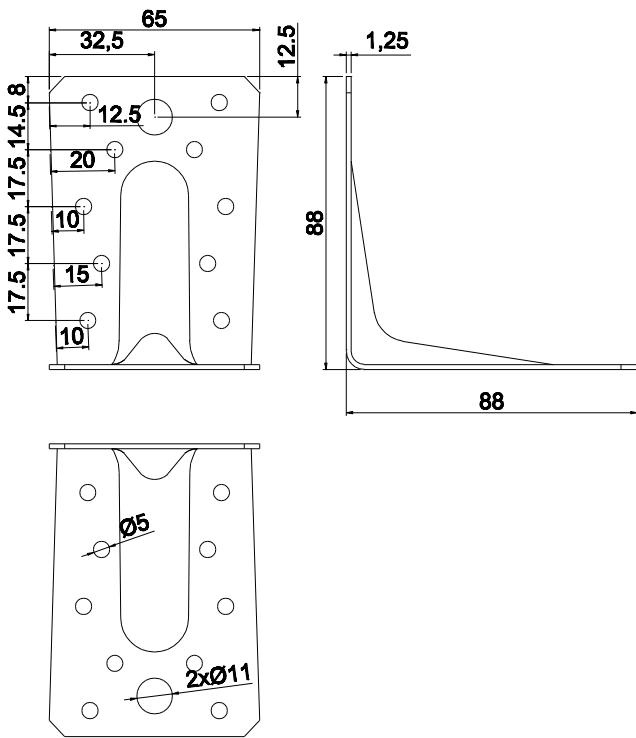

Figure D49-4: ACR9012

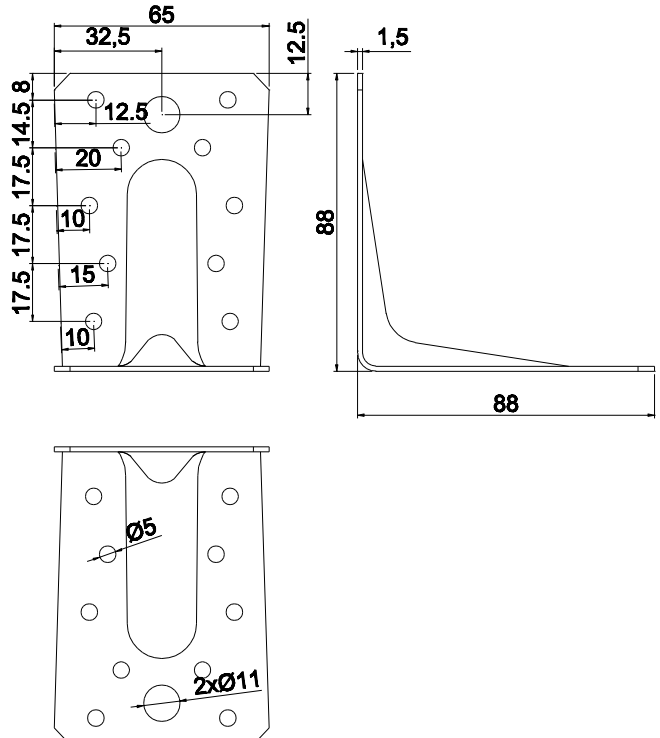

Figure D49-5: ACR9015

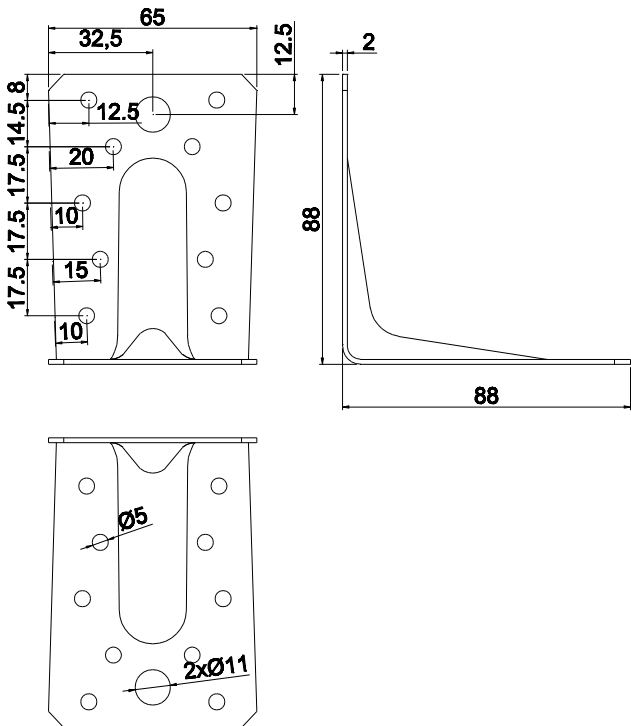

Figure D49-6: ACR9020



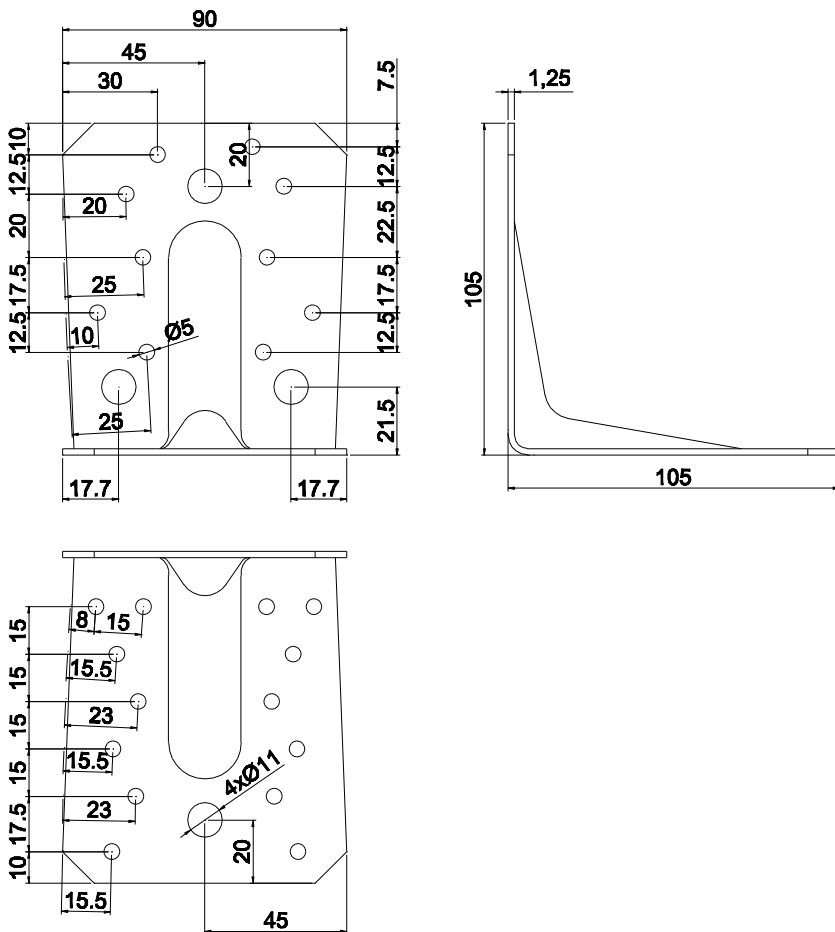

Figure D49-7: ACR10512

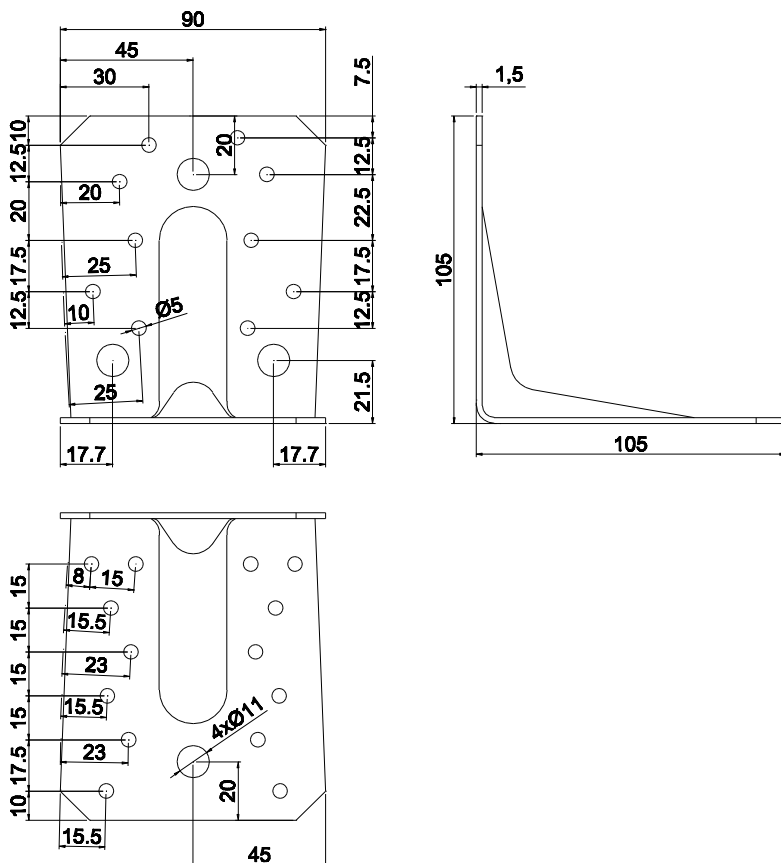

Figure D49-8: ACR10515

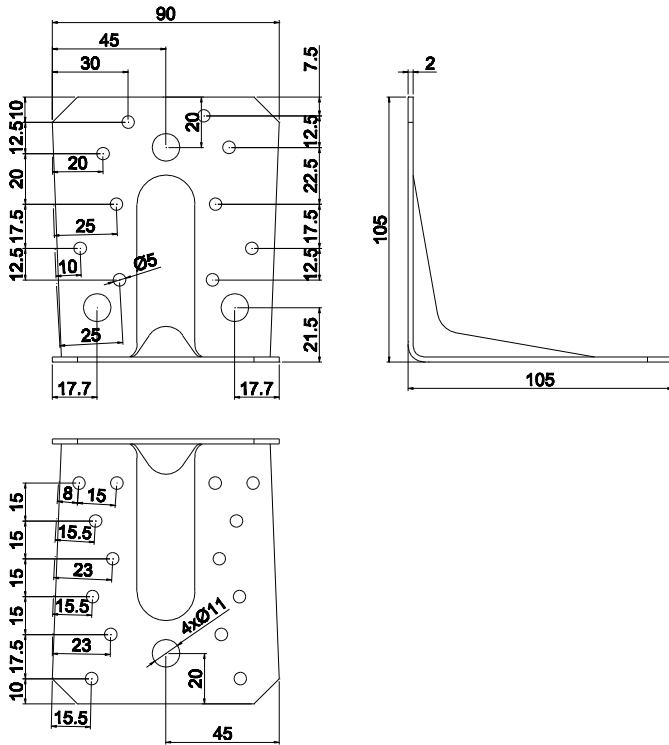

Figure D49-9: ACR10520

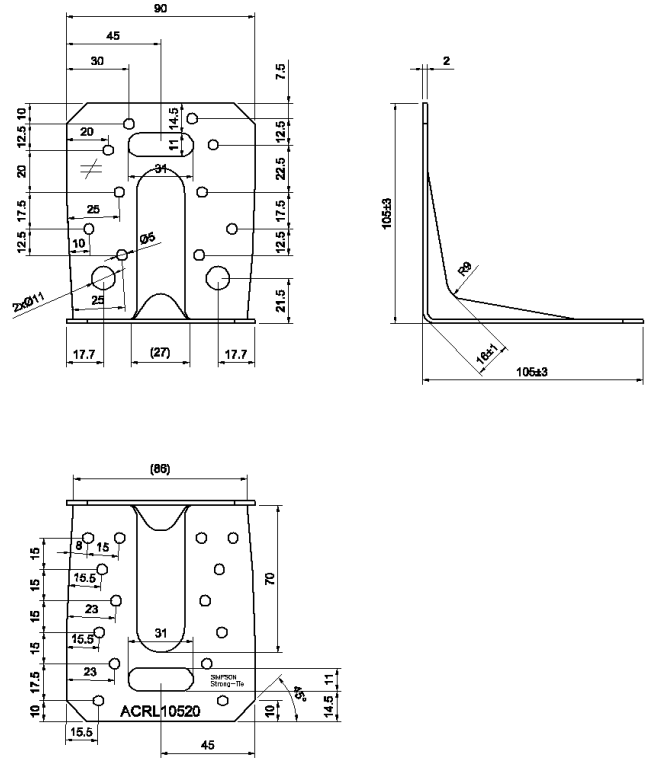

Figure D49-9a: ACRL10520

**Material:**

Standard material: S250GD + Z275 according to EN 10346  
Or stainless steel according to clause II-1

**Nail pattern:**

**Timber to timber connection**

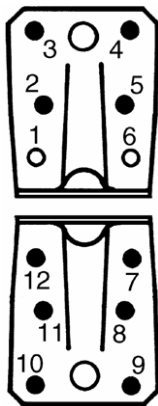

Figure D49-10: ACR7010/ACR7012/ACR7015 nail pattern

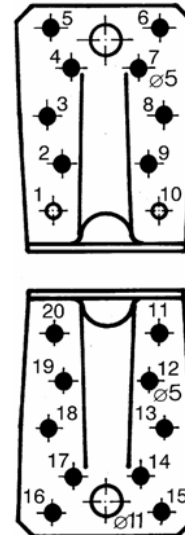

Figure D49-11: ACR9012/ACR9015/ACR9020 nail pattern

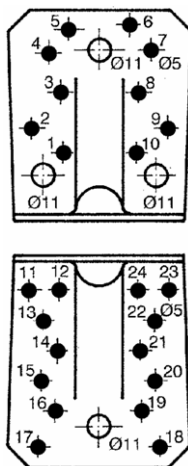

Figure D49-12: ACR10512/ACR10515/ACR10520/ACRL10520 nail pattern

**Timber to rigid support connection**

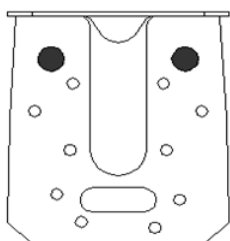
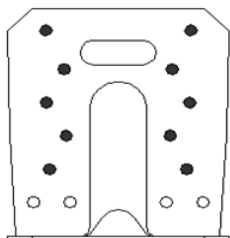

Figure D49-13: ACR10520/ACRL10520 Nail pattern 1 (NP1)

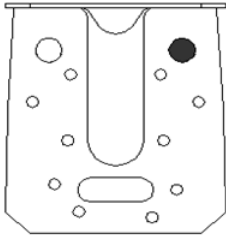
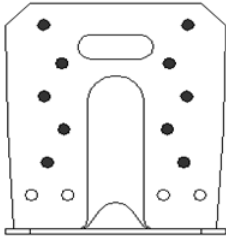

Figure D49-14: ACR10520/ACRL10520 Nail pattern 2 (NP2)

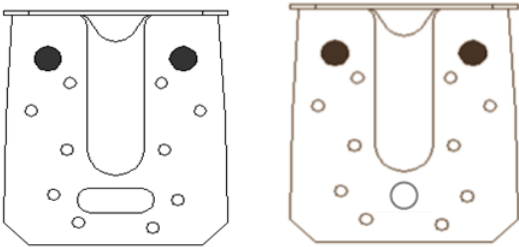
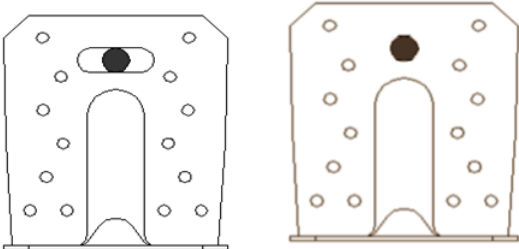

Figure D49-15: ACR10520/ACRL10520 Nail pattern 3 (NP3)

**Characteristic capacities:**

Table D49-1 ACR – Beam to beam connection – 2 angle brackets

2 angle brackets per connection			Characteristic capacity per connection [kN]		
Nailing Connector nail according to ETA-04/0013			$R_{1,k}$	$R_{2/3,k}$	$R_{4/5,k}$
ACR7010	Maximum nailing 4+6 See fig. D49-10	CNA4,0x35	2,2		
ACR7012		CNA4,0x35	3,2		
		CNA4,0x35	3,9		
ACR7015		CNA4,0x40	5,3	5,0	$\frac{2,13b+165}{k_{mod}^{0,7}}$ e max 8,0
		CNA4,0x60	8,9	7,3	$\frac{3,54b+200}{k_{mod}^{0,6}}$ e max 13,2
ACR9012	Maximum nailing 8+10 See fig. D49-11	CNA4,0x35	7,9		
ACR9015		CNA4,0x35	8,9		
		CNA4,0x35	9,2		
ACR9020		CNA4,0x40	8,0	9,3	$\frac{6,7b+369}{k_{mod}^{0,7}}$ e - 10,7 max 9,7
		CNA4,0x60	13,3	11,9	$\frac{8b+343}{k_{mod}}$ e - 10,7 max $14,5/k_{mod}^{0,15}$
ACR10512	Maximum nailing 10+14 See fig. D49-12	CNA4,0x35	10,9		
ACR10515		CNA4,0x35	13,0		
		CNA4,0x35	13,4		
ACR10520 ACRL10520		CNA4,0x40	10,8	14,5	$\frac{12,7b}{k_{mod}^{0,7}} + \frac{565}{k_{mod}}$ e - 10,7 max $14,1/k_{mod}^{0,25}$
		CNA4,0x60	17,9	20,3	$\frac{15,6b}{k_{mod}^{0,6}} + \frac{556}{k_{mod}}$ e - 10,7 max $21,2/k_{mod}^{0,15}$

b and e are in mm.

Table D49-2 ACR – Beam to beam connection – 1 angle bracket

1 angle bracket per connection	Nailing	Characteristic capacity per connection [kN]							
		R <sub>1,k</sub>		R <sub>2/3,k</sub>		R <sub>4,k</sub>		R <sub>5,k</sub>	
		CNA connector nails according to ETA-04/0013							
		4,0x40	4,0x60	4,0x40	4,0x60	4,0x40	4,0x60	4,0x40	4,0x60
ACR7015	Maximum nailing 4+6 See fig. D49-10	2,7	4,5	2,5	3,7	min of: 2,4 <u>51</u> e·k <sub>mod</sub> <u>14</u> (e-35)·k <sub>mod</sub>	min of: 3,1 <u>51</u> e·k <sub>mod</sub> <u>14</u> (e-35)·k <sub>mod</sub>	min of: 2,5 <u>30</u> 55-e <u>27b+53</u> e	min of: 4,2 <u>49</u> 55-e <u>44b+89</u> e
ACR9020	Maximum nailing 8+10 See fig. D49-11	4	6,7	4,7	6	e= 1 4,7 20 4,3/k <sub>mod</sub> <sup>0,2</sup> 50 1,8/k <sub>mod</sub> <sup>0,2</sup> 75 1,2/k <sub>mod</sub> <sup>0,2</sup> 100 0,8 125 0,5 150 0,4	e= min of: 1 6,1 20 6,1 50 2,6/k <sub>mod</sub> <sup>0,2</sup> ; 2,2/k <sub>mod</sub> 75 1,8/k <sub>mod</sub> <sup>0,2</sup> ; 1,5/k <sub>mod</sub> 100 1,1/k <sub>mod</sub> <sup>0,2</sup> ; 1,0/k <sub>mod</sub> 125 0,8 ; 0,7/k <sub>mod</sub> 150 0,8 ; 0,6/k <sub>mod</sub>	min of: <u>5,8</u> k <sub>mod</sub> <sup>0,4</sup> <u>77</u> 68 - e <u>7,2/(k<sub>mod</sub><sup>0,75</sup>·b-308/k<sub>mod</sub><sup>0,55</sup>)</u> e - 68	min of: <u>8,5</u> k <sub>mod</sub> <sup>0,25</sup> <u>129</u> 68 - e <u>8,8/(k<sub>mod</sub><sup>0,6</sup>·b-408/k<sub>mod</sub><sup>0,45</sup>)</u> e - 68
ACR10520 ACRL10520	Maximum nailing 10+14 See fig. D49-12	5,4	9	7,3	10,2	e= 1 7,2 20 7,2 50 3,4/k <sub>mod</sub> <sup>0,35</sup> 75 2,3/k <sub>mod</sub> <sup>0,35</sup> 100 1,7/k <sub>mod</sub> <sup>0,35</sup> 125 1,4/k <sub>mod</sub> <sup>0,35</sup> 150 1,1/k <sub>mod</sub> <sup>0,35</sup>	e= min of: 1 9,2 20 9,2 50 4,9/k <sub>mod</sub> <sup>0,35</sup> 75 3,3/k <sub>mod</sub> <sup>0,3</sup> 100 2,3/k <sub>mod</sub> <sup>0,3</sup> ; 2,3/k <sub>mod</sub> 125 1,9/k <sub>mod</sub> <sup>0,3</sup> ; 1,7/k <sub>mod</sub> 150 1,4/k <sub>mod</sub> <sup>0,3</sup> ; 1,4/k <sub>mod</sub>	min of: <u>8,1</u> k <sub>mod</sub> <sup>0,45</sup> <u>137</u> 85 - e <u>12,8/(k<sub>mod</sub><sup>0,7</sup>·b-639/k<sub>mod</sub><sup>0,55</sup>)</u> e - 85	min of: <u>11,2</u> k <sub>mod</sub> <sup>0,35</sup> <u>228</u> 85 - e <u>15,7/(k<sub>mod</sub><sup>0,6</sup>·b-840/k<sub>mod</sub><sup>0,45</sup>)</u> e - 85

b and e are in mm.

The capacities have been found based on the assumption that the purlin is prevented from rotation.

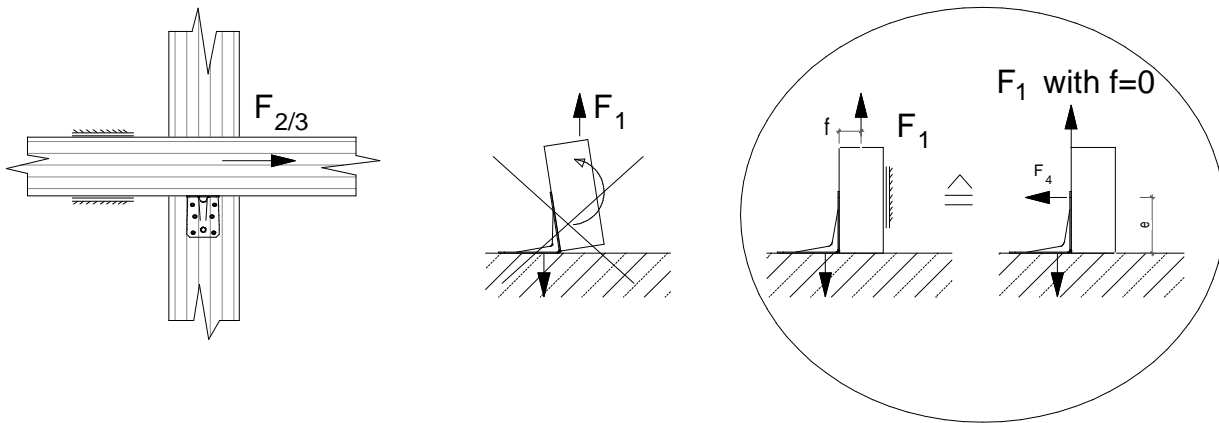

Table D49-3

ACR – Beam to rigid support connection – 2 angle brackets

ACR10520 / ACRL10520 - Timber C24 on rigid support (kN)										
Nailing	$R_{1,k}$					$R_{2,k}$				
	Type of nails					Type of nails				
	4.0x35	4.0x40	4.0x50	4.0x60	4.0x75	4.0x35	4.0x40	4.0x50	4.0x60	4.0x75
10 CNA + 2 bolts $\varnothing 10$ See fig. D49-14	24.1	27.6	28.5	28.5	28.5	10.8	11.7	14.2	15.1	16
10 CNA + 1 bolts $\varnothing 10$ See fig. D49-15	10.1	11.7	15	15	15	6	7	9	10.5	11.7
1 bolt $\varnothing 10$ + 2 bolts $\varnothing 10$ See fig. D49-16	7.5*					-	-	-	-	-

\*In this case the test had shown that the limiting factor is the bolt resistance of connection ACRL to timber. The bolt resistance must be calculated using the Eurocode 5 §8.2.3 and consider only failure mode (j) and (k).

ACR10520 / ACRL10520 - Timber C24 on rigid support (kN)

## Annex D50 – MAXIMUS

### Product Name:

Product Name	Alternative name			
	UK	France	Denmark	Germany
MAXIMUS	--	--	--	--

### Drawing:

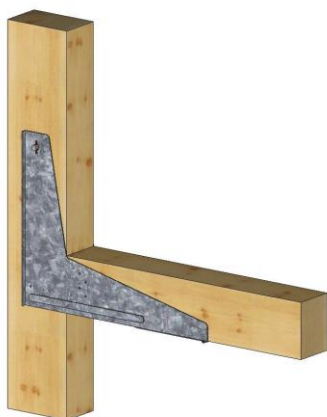
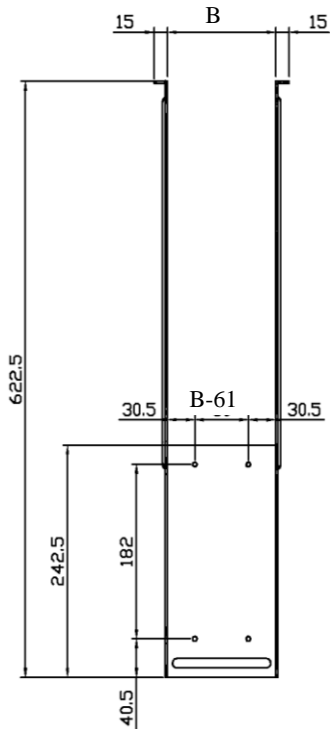
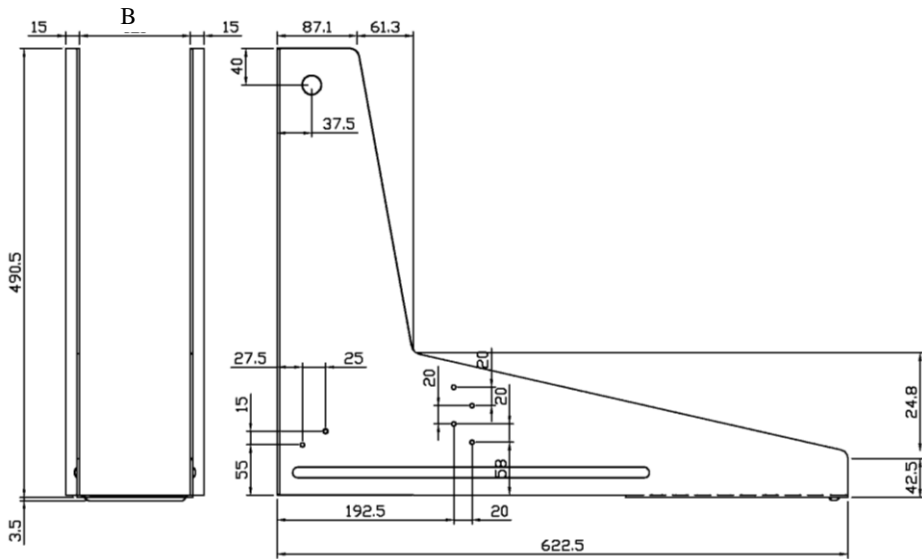

Figure D50-1: MAXIMUS typical installation





- Material thickness 2,5 mm
- $100\text{mm} \leq B \leq 240\text{ mm}$
- Small holes diameter 5 mm
- Big hole diameter 21 mm

Figure D50-1: MAXIMUS dimensions

**Material:**

Standard material: S250GD + Z275 according to EN 10346

Or stainless steel according to clause II-1

**Nail pattern:**

Column to lever arm connection

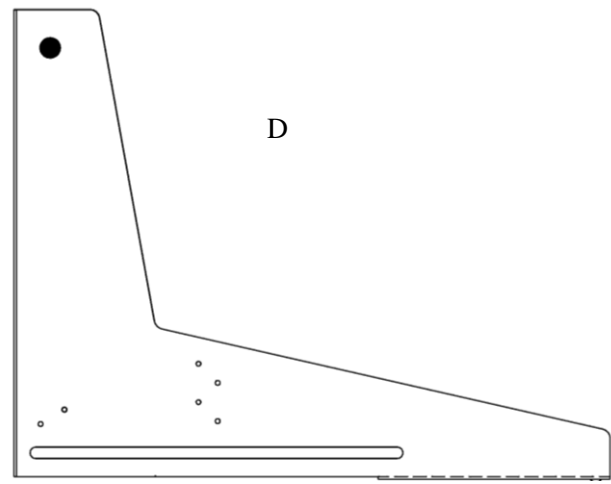
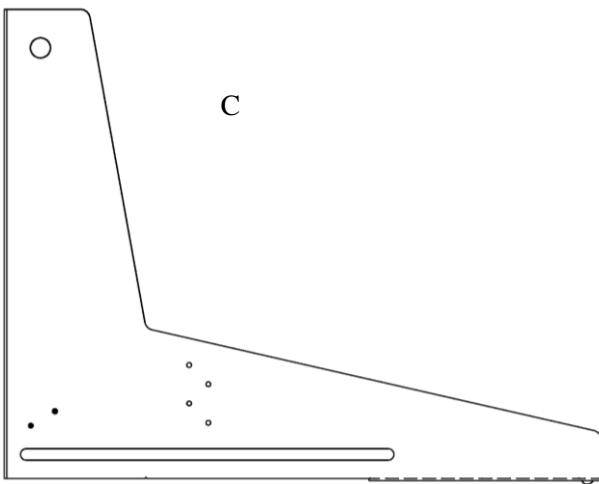
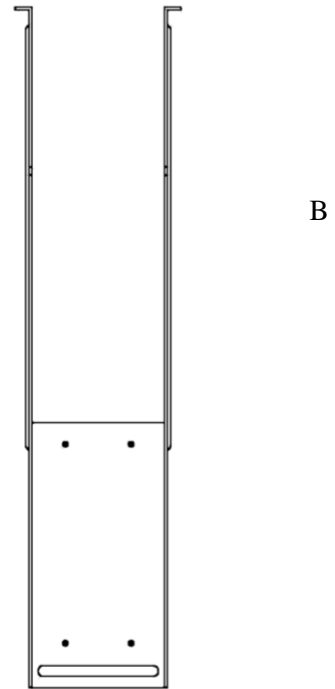
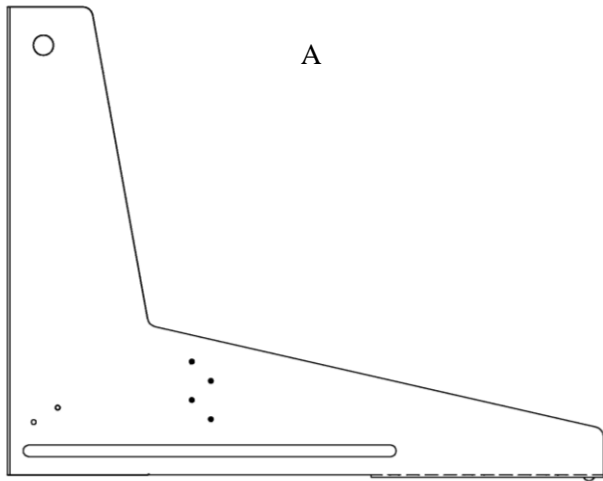

Figure D50-2: MAXIMUS nail pattern

A – 4 x CSA5,0x50 on each side

B – 4 x CSA5,0x50 on the bottom

C – 2 x CSA5,0x50 on each side

D – 1x bolt M20 or a 20 mm dowel with additional securing pins

For a downward force at least the fasteners shown in A,B and D shall be inserted. For an uplift force the fasteners shown in A,B,C and D are required.

**Design Basis:**

The loads have been assumed to act on a cantilevering horizontal timber member fastened to a vertical timber by the MAXIMUS connector using the fastener pattern shown in figure D50-2. Other spans or loads can be verified by engineering judgement. The relevant moment to evaluate deflection is stated as:  $M=q \cdot L^2/2$

Possible load distributions which have been considered:

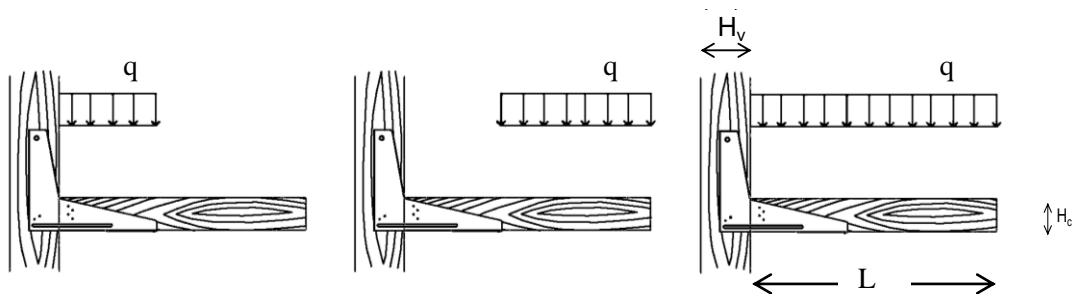

Figure D50-3: MAXIMUS possible load distributions

**Modified characteristic capacity:**

The strength and stiffness values determined are directly applicable to timber of the strength class C24 and better with the following dimensions:

The horizontal cantilevered timber member:      Depth  $H_c = 160\text{mm}$  ; Width B as vertical member(post)

The vertical member:      Depth  $H_v = 220\text{ mm}^1$  for  $B < 139\text{mm}$   
 $220\text{mm}^1 \leq H_v \leq 340\text{ mm}$  for  $139 \leq B < 159\text{mm}$   
 $220\text{mm}^1 \leq H_v < 700\text{mm}$  for  $B \geq 159\text{mm}$

<sup>1)</sup> : These values may be reduced to 180mm if only downward forces can occur.

Higher depths  $H_v$  can be tolerated if a splitting reinforcement designed for at least  $F_k=8,8\text{kN}$  is applied near the dowel. If the width B is smaller than 120 mm the characteristic load-carrying capacity can be determined by applying a factor  $B/120\text{ mm}$  to the capacities listed in table D50-1.

The characteristic load-carrying capacity  $q_{R,k}$  for a cantilever with a length  $L = 1200\text{ mm}$  is listed in the table D50-1 below . The common types of distributed loads have been evaluated also considering the possible positions of distributed loads shown in the figure D50-3.

Table D50-1      MAXIMUS – Beam to post connection

Load duration	Spring stiffness* $C_\phi$ of the connection for a downward force [kNm]	Characteristic distributed load capacity $q_{R,k}$ per connector [kN/m] and a lever arm $L=1200\text{mm}$	
		downward	uplift
P	43	7,02	-2,60
L	43		
M	48		
S	67		
I	85		

\*) $C_\phi$  shall be reduced to 60% of these values if the timber moisture exceeds 18% for longer term

**Annex D51 – AT2**

**Product Name:**

Product Name	Alternative name			
	UK	France	Denmark	Germany
AT2	--	--	--	--

**Drawing:**

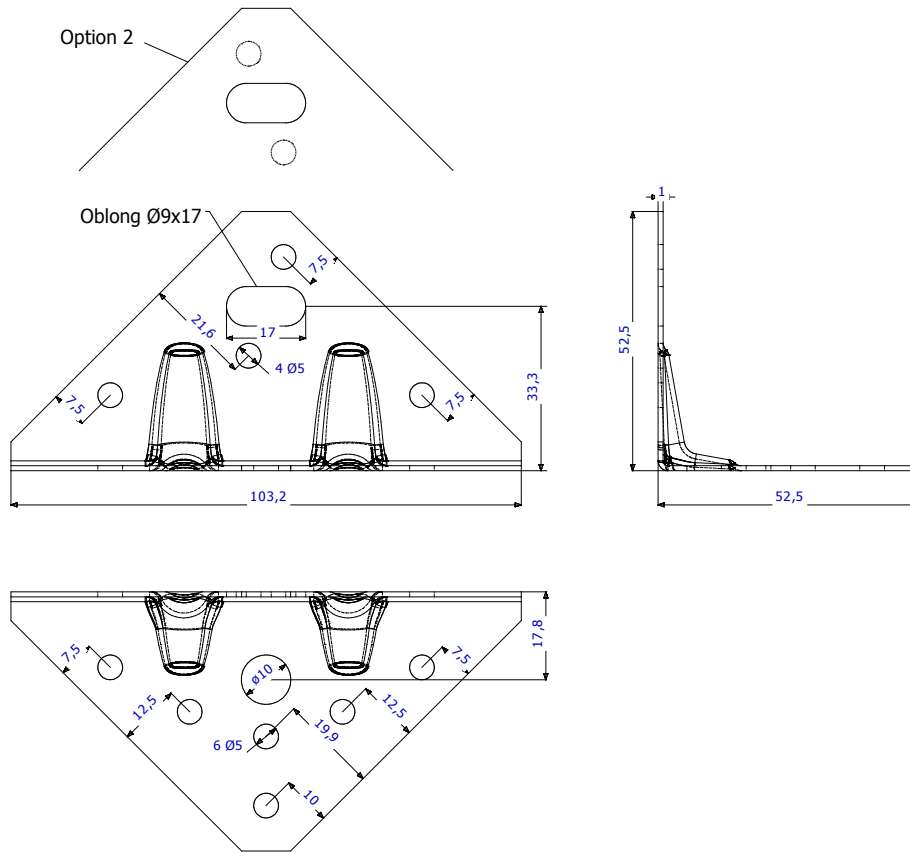

Figure D51-1: AT2

**Material:**

Standard material: S250GD + Z275 according to EN 10346

Or stainless steel according to clause II-1

**Nail pattern:**

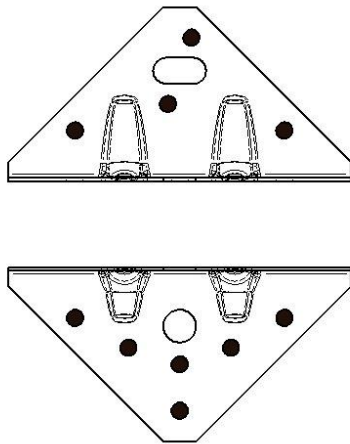

Figure D51-2  
Full nailing  
4 nails on vertical flap  
6 nails on the horizontal flap

Beam to beam connection

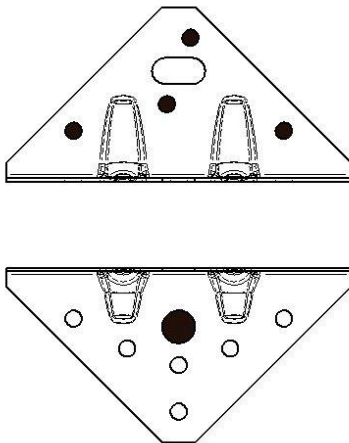

Figure D51-3  
4 nails on vertical flap  
1 anchor on the horizontal flap

Beam to concrete connection

### Characteristic capacities

Table D51-1 AT2 – Beam to beam connection – 2 angle brackets

2 Angle Brackets per connection		
Characteristic capacity per connection (kN)		
Nailing	$R_{1,k}$	$R_{2,k} = R_{3,k}$
	Connector nail according to ETA-04/0013	
	Ø4,0x35	Ø4,0x35
Vertical flap: 4 nails Horizontal flap: 6 nails  See fig. D51-2	5,3	11,1

Table D51-2 AT2 – Timber to rigid support connection – 2 angle brackets

2 Angle Brackets per connection		
Characteristic capacity per connection (kN)		
Nailing	$R_{1,k}$	$R_{2,k} = R_{3,k}$
	Connector nail according to ETA-04/0013	
	Ø4,0x35	Ø4,0x35
Vertical flap: 4 nails Horizontal flap: 1 anchor Ø8  See fig. D51-3	4,5	8,0

AT2	connection with 2 angle brackets			
factor:	for $F_1$	for $F_{2/3}$	for $F_{4/5}$ , bolt 1	for $F_{4/5}$ , bolt 2
$k_{ax}$	0,62	0,35	-	-
$k_{lat}$	-	0,50	-	-

For each bolt it's needed to check:  $R_{bolt,d,lateral} \geq k_{lat} \times F_{i,d}$  ;  $R_{bolt,d,axial} \geq k_{ax} \times F_{i,d}$  ; and also the combination

**Annex D52 - ABR865**

Product Name	alternative names			
	UK	France	DK	D
ABR865				

**Figure D52-1: Drawings**

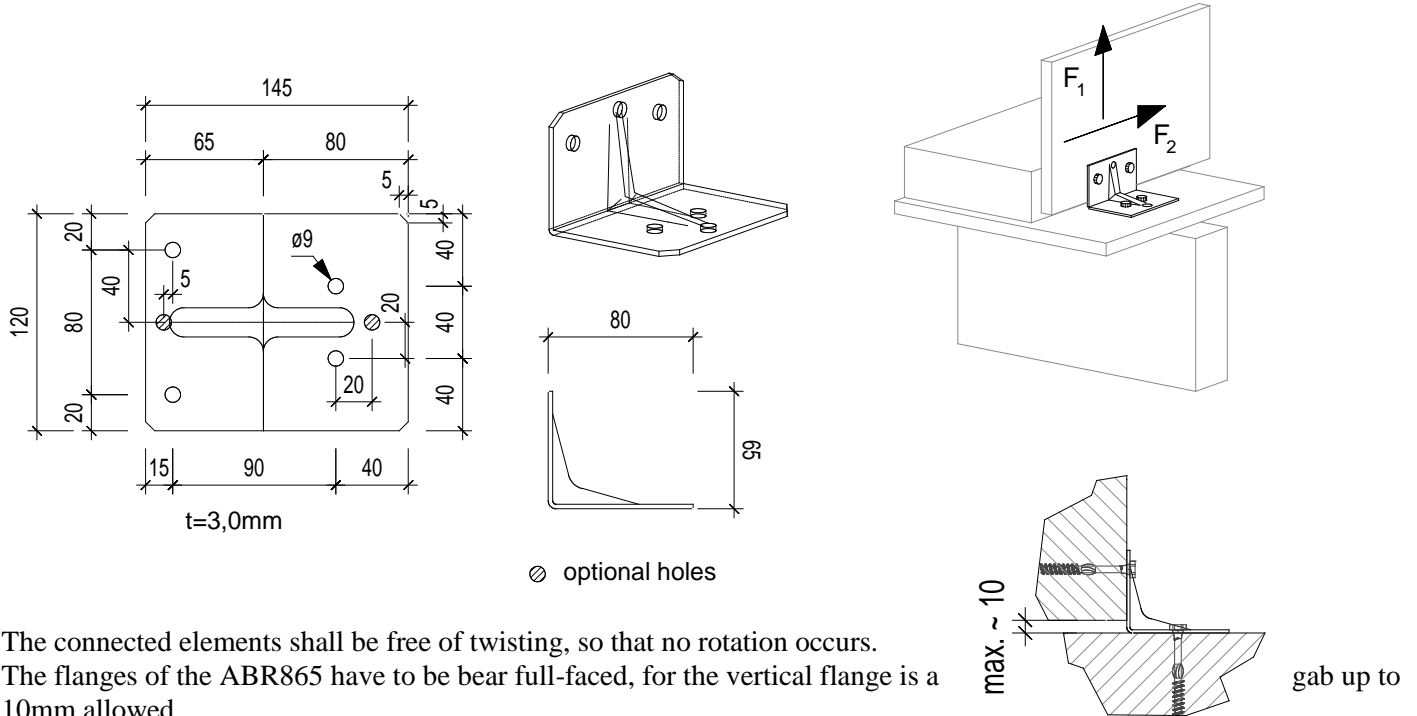

The connected elements shall be free of twisting, so that no rotation occurs. The flanges of the ABR865 have to bear full-faced, for the vertical flange is a 10mm allowed.

**Table D52-1: Size specification**

n/a

**Table D52-2: Material specification**

Material thickness	Material Grades	Coating specification
3	S250 GD according to EN 10326:2004	Pre-galvanized steel min Z275 according to EN10326:2004

Or stainless steel according to clause II-1

**Figure D52-2: Nail/screw pattern**

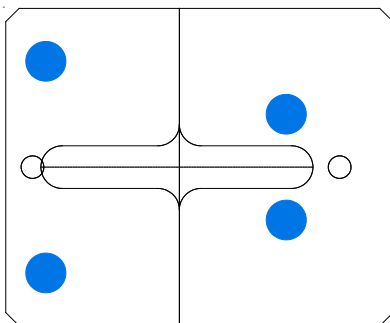

The optional holes are only for constructive using of the ABR865.

**Table D52-3: Characteristic capacity****Load direction F<sub>1</sub>:**Characteristic capacity  $R_{1,k}$  [kN] = min [tablevalue; 8,48/ $k_{mod}$ ]

$R_{ax,k}$ [kN]	$R_{lat,k}$ [kN]										
	4	4,5	5	5,0	6	6,5	7	7,5	8	8,5	9
4,0	5,9	6,1	6,1	6,1	6,1	6,1	6,1	6,1	6,1	6,1	6,1
4,5	6,2	6,7	6,8	6,8	6,8	6,8	6,8	6,8	6,8	6,8	6,8
5,0	6,5	7,0	7,4	7,6	7,6	7,6	7,6	7,6	7,6	7,6	7,6
5,5	6,7	7,2	7,7	8,1	8,4	8,4	8,4	8,4	8,4	8,4	8,4
6,0	6,8	7,4	8,0	8,5	8,9	9,1	9,1	9,1	9,1	9,1	9,1
6,5	7,0	7,6	8,2	8,7	9,2	9,6	9,9	9,9	9,9	9,9	9,9
7,0	7,1	7,8	8,4	9,0	9,5	9,9	10,4	10,6	10,6	10,6	10,6
7,5	7,2	7,9	8,6	9,2	9,7	10,2	10,7	11,1	11,4	11,4	11,4
8,0	7,3	8,0	8,7	9,3	9,9	10,5	11,0	11,4	11,8	12,2	12,2
8,5	7,4	8,1	8,8	9,5	10,1	10,7	11,2	11,7	12,2	12,6	12,9
9,0	7,4	8,2	8,9	9,6	10,3	10,9	11,4	12,0	12,4	12,9	13,3
9,5	7,5	8,3	9,0	9,7	10,4	11,0	11,6	12,2	12,7	13,2	13,6
10,0	7,5	8,3	9,1	9,8	10,5	11,2	11,8	12,4	12,9	13,5	13,9
10,5	7,6	8,4	9,2	9,9	10,6	11,3	12,0	12,6	13,2	13,7	14,1

**Load direction F<sub>2</sub>:**Characteristic capacity  $R_{2,k}$  [kN]

$R_{ax,k}$ [kN]	$R_{lat,k}$ [kN]										
	4	4,5	5	5,0	6	6,5	7	7,5	8	8,5	9
4,0	5,96	6,51	7,01	7,47	7,88	8,25	8,25	8,25	8,25	8,25	8,25
4,5	6,11	6,71	7,26	7,77	8,23	8,25					
5,0	6,23	6,86	7,45	8,01	8,25						
5,5	6,32	6,98	7,61	8,20							
6,0	6,39	7,07	7,73	8,25							
6,5	6,44	7,15	7,83								
7,0	6,49	7,21	7,91								
7,5	6,53	7,27	7,98								
8,0	6,56	7,31	8,04								
8,5	6,58	7,35	8,09								
9,0	6,61	7,38	8,13								
9,5	6,63	7,40	8,17								
10,0	6,64	7,43	8,20								
10,5	6,66	7,45	8,22								

The tables are based on the characteristic capacities of the used screws with  $R_{lat,k}$  for the lateral (shear) capacity, and  $R_{ax,k}$  for the axial (tension) capacity.

For blank cells are no higher values given as the last filled cell before in the same column.



The values for characteristic capacities of the fastener with  $R_{lat,k}=4,75kN$  and  $R_{ax,k}=7,04kN$  are for connection as described following with using screws 8,0x120 ASSY Kombi 3.0 according to ETA 11/0190:

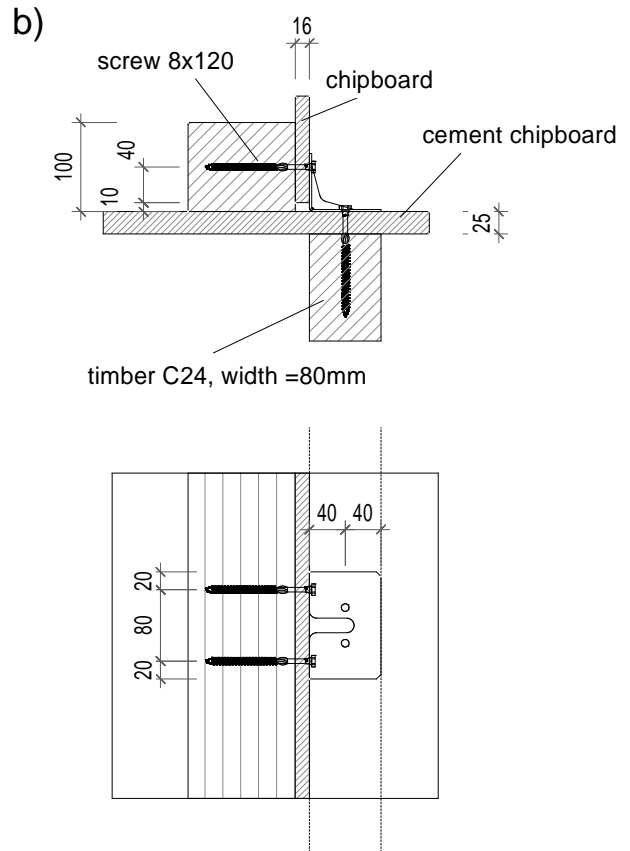
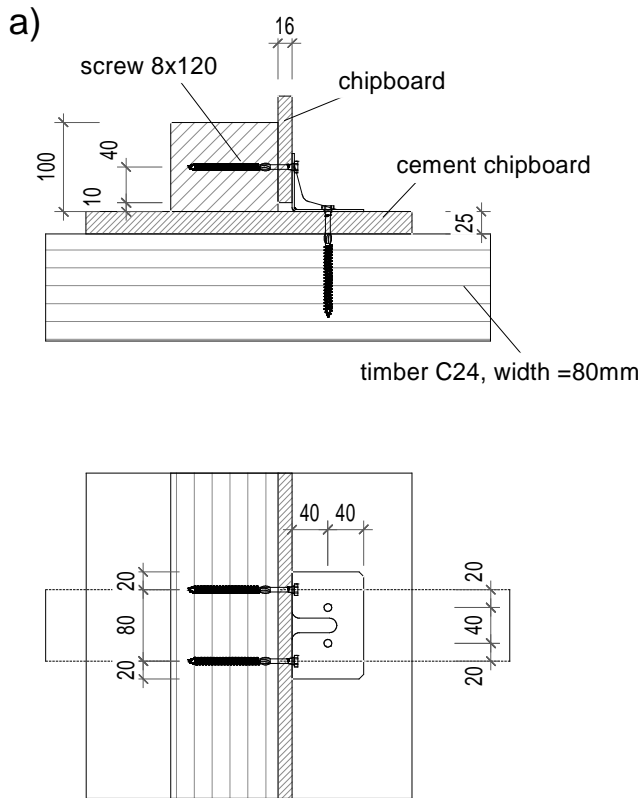

Chipboard class P4 according to EN 13986

Cement-bonded particleboard (in drawings named cement chipboard) according to EN 13986

Both layers are connected shear fixed with the timber.

## Annex D53 - ACFET200 / ACFET200PP

Product Name	Alternative Names			
	Branch 36	Branch 40	Branch 46	Branch 47
ACFET200				
ACFET200PP				

**Figure D53-1: Drawings**

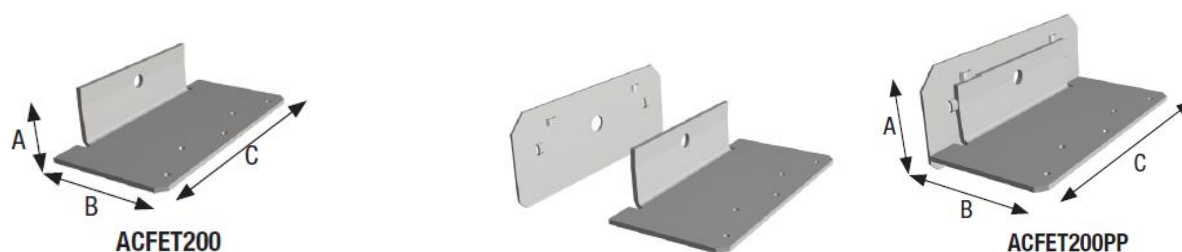

Typical installation:

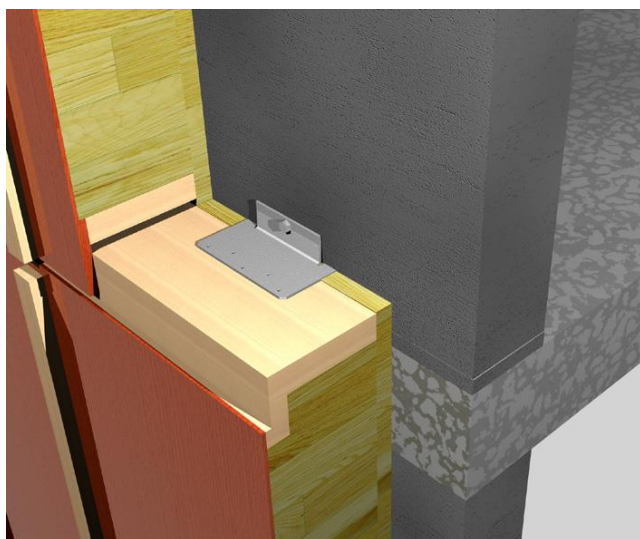

ACFET200 attached on a concrete wall

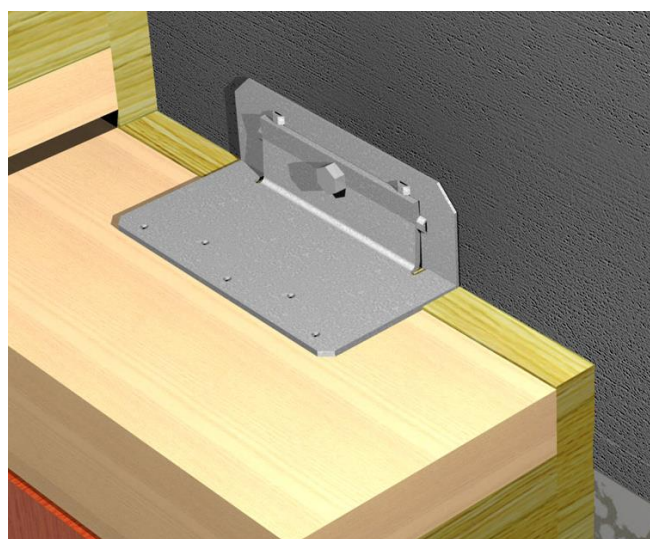

ACFET200PP attached on a Lightweight Aggregate concrete (LAC) wall

**Table D53-1: Size specification**

Model	A	B	C
ACFET200	49	100	200
ACFET200PP	78	102	200

**Table D53-2: Material specification**

Material Thickness	Material Grades	Coating Specification
4,0	S250 to EN 10346:2009	Z275

Or stainless steel according to clause II-1

**Table D53-3: Characteristic capacity**

Fastener Specification		Characteristic capacity of Connector (kN)	Vertical displacement (mm)
Type	Qty		
M10 Concrete Screw/Bolt	1	$G_k = 185 \text{ kNmm} / (e-5 \text{ mm})$	$u_{init} = G \times (e-5 \text{ mm})^2 / 2400$

The concrete Screw/Bolt is subjected to a shear force of  $F_{v,k} = G_k$  and a tension force of  $F_{ax,k} = G_k \times e / 30$

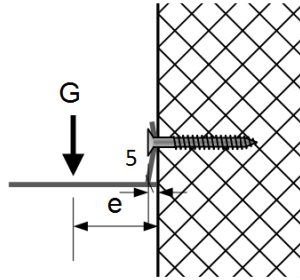

**Annex D54 - ANP**

Product Name	Alternative Names			
	Branch 36	Branch 40	Branch 46	Branch 47
ANP				

**Figure D54-1: Drawings**

- 1) ANP251020100  
ANP2561060  
ANP254660
- 2) all other ANP-sizes:

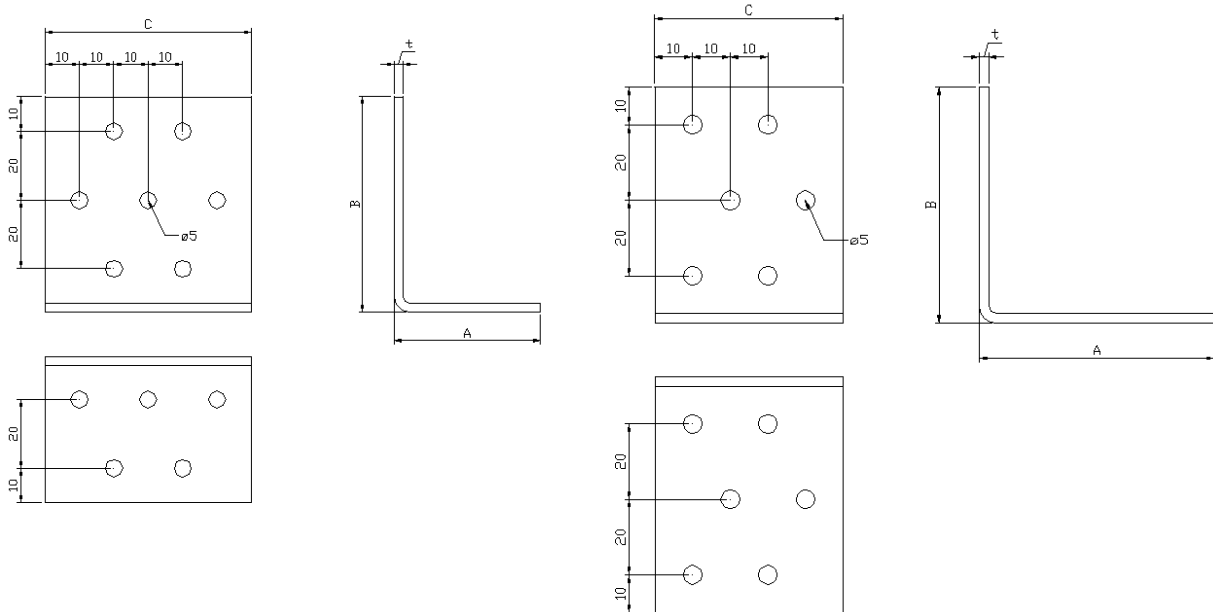
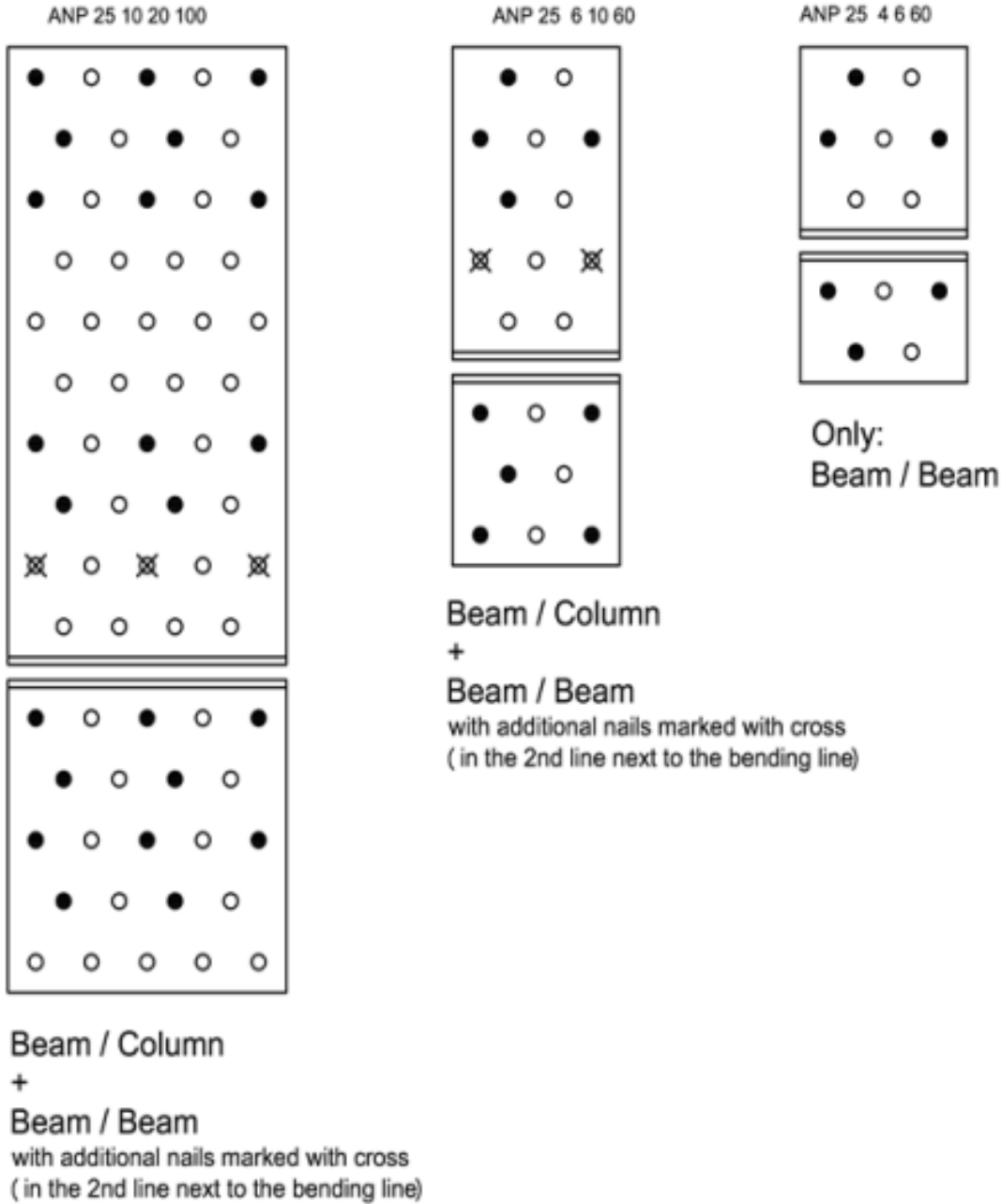

**Table D54-1: Size specification**

Model No.	Dimensions [mm]			
	A	B	C	t
ANP 25 10 10 100	100	100	100	2,5
ANP 25 10 10 80	100	100	80	2,5
ANP 25 10 10 60	100	100	60	2,5
ANP 25 8 8 100	80	80	100	2,5
ANP 25 8 8 80	80	80	80	2,5
ANP 25 8 8 60	80	80	60	2,5
ANP 25 6 6 100	60	60	100	2,5
ANP 25 6 6 80	60	60	80	2,5
ANP 25 6 6 60	60	60	60	2,5
ANP 25 6 6 50	60	60	50	2,5
ANP 25 10 20 100	100	200	100	2,5
ANP 25 6 10 60	60	100	60	2,5
ANP 25 4 6 60	40	60	60	2,5

**Figure D54-2: Nailpattern**

- 1) ANP251020100
- ANP2561060
- ANP254660



2) all other ANP-sizes:

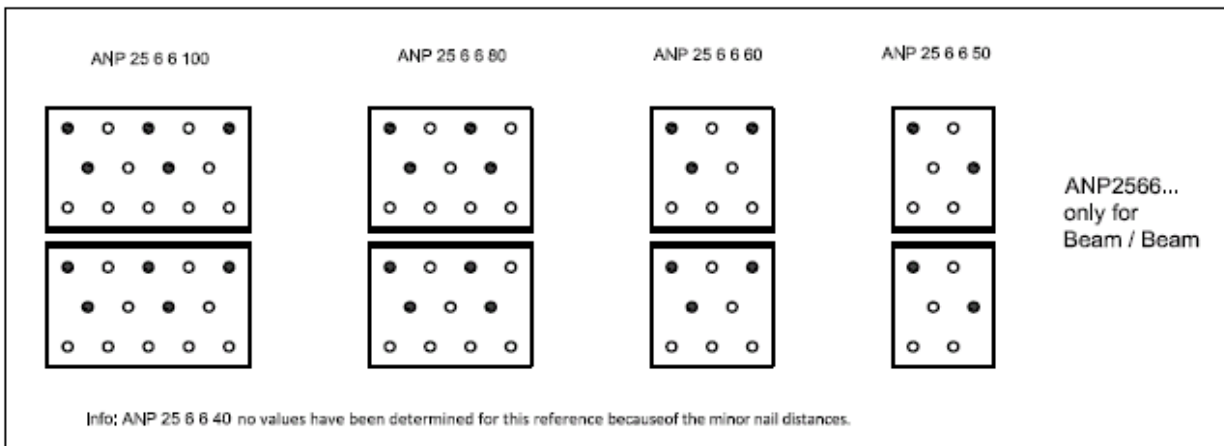
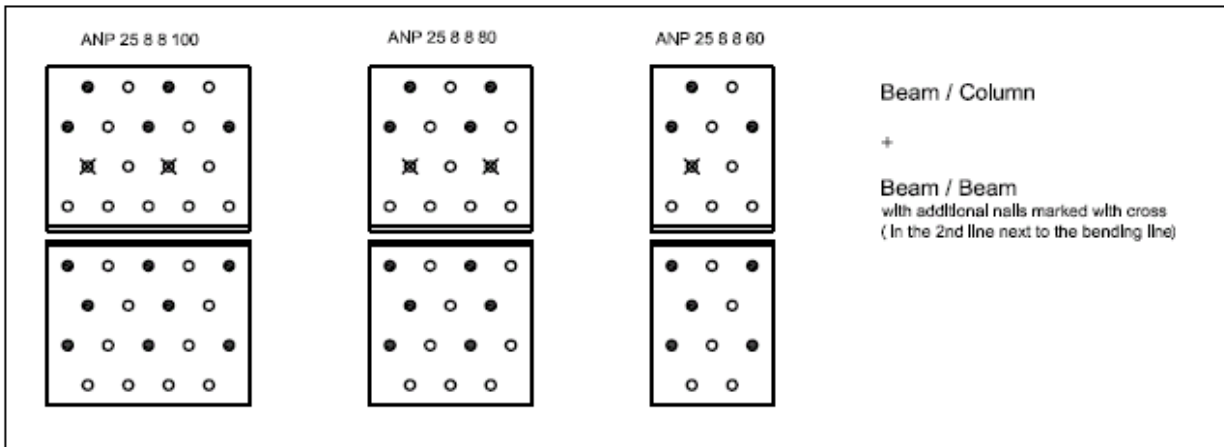
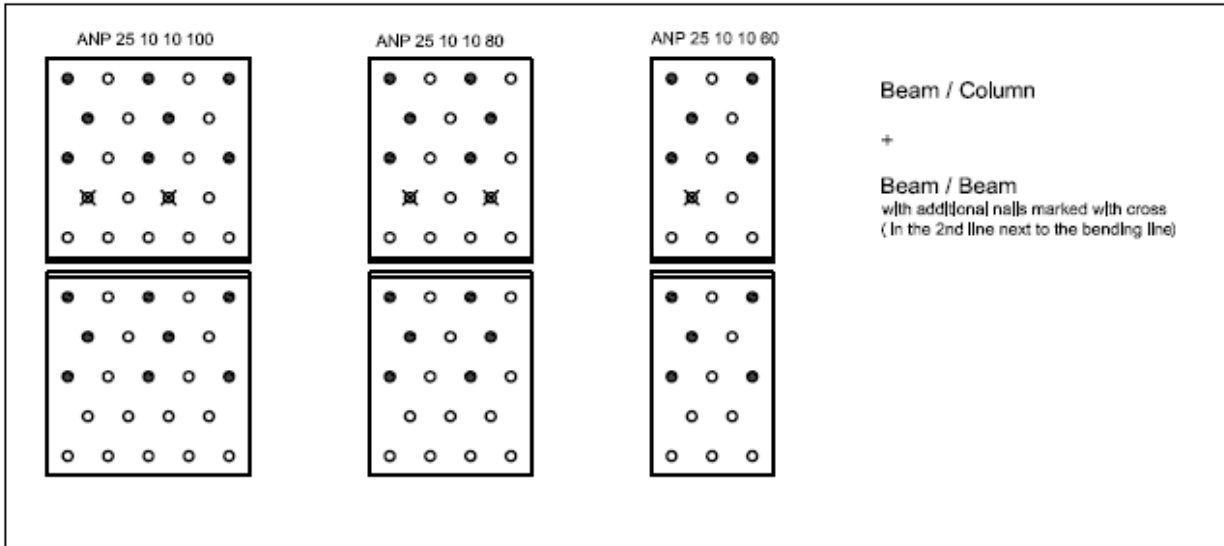



**Table D53-4: Characteristic capacity beam to beam (connection with two ANP)**

Model No.	Number of Fasteners		R <sub>1,k</sub> (kN); Characteristic Capacities			R <sub>2/3,k</sub> (kN) Characteristic Capacities		
	Supporting Member	Supported Member	CNA 4.0x40	CNA 4.0x50	CNA 4.0x60	CNA 4.0x40	CNA 4.0x50	CNA 4.0x60
ANP 25 10 10 100	10	8	6,48	8,30	9,64	11,02	13,64	15,00
ANP 25 10 10 80	8	8	5,46	6,50	7,16	7,76	9,64	10,60
ANP 25 10 10 60	6	5	3,88	4,96	6,04	5,86	7,22	7,88
ANP 25 8 8 100	7	8	6,44	8,14	9,74	9,20	11,46	12,70
ANP 25 8 8 80	6	6	5,34	6,60	7,26	7,28	8,98	9,90
ANP 25 8 8 60	4	5	3,88	4,90	5,92	3,96	4,94	5,54
ANP 25 6 6 100	5	5	5,9	7,84	9,26	7,96	9,94	11,06
ANP 25 6 6 80	4	4	5,12	6,28	7,42	6,02	7,50	8,42
ANP 25 6 6 60	3	3	3,6	4,8	5,70	3,38	4,20	4,68
ANP 25 6 6 50	2	2	2,82	3,4	3,96	2,88	3,58	3,96
ANP 25 10 20 100	16	10	7,18	9,56	11,96	13,14	16,14	17,52
ANP 25 6 10 60	6	5	3,94	5,26	6,58	5,74	7,10	7,70
ANP 25 4 6 60	3	3	3,48	4,64	5,80	3,74	4,68	5,32



**Annex D55 –A-bracket**

Product Name	Alternative Names			
	Branch 36	Branch 40	Branch 46	Branch 47
A21				
A23				
A33				
A88				

**Figure D55-1: Drawings**

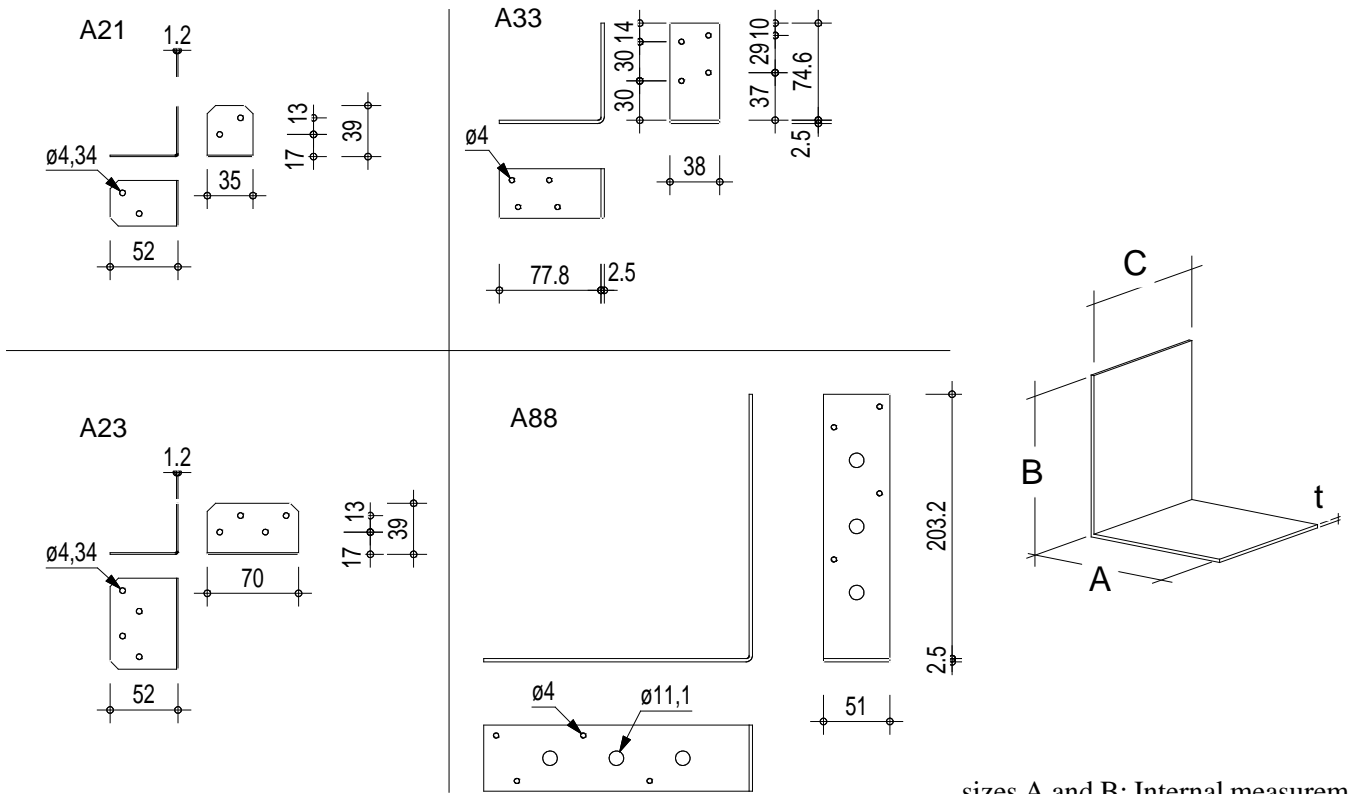

sizes A and B: Internal measurements

**Figure D55-2: Nailpattern**  
only Full Nailing should be used.

**Table D55-1: Size specification**

Model No.	Dimensions [mm]			
	A	B	C	t
A21	38	50,8	35	1,2
A23	38	50,8	70	1,2
A33	74,6	77,8	38	2,5
A88	203,2	203,2	51	2,5

**Table D55-2: Material specification**

type	Material Thickness	Material Grades	Coating Specification
A21; A23	1,2	SS Grade 33	G90
A33; A88	2,5	SS Grade 33	G90

Or stainless steel according to clause II-1

### Characteristic Capacities under vertically upward load (F<sub>1</sub>)

For the types **A21** and **A23** the following formula needs to be used:  
Therefore the values R<sub>1,k</sub> are stated in the table below.

$$R_{1,d} = R_{1,k} \times \frac{k_{\text{mod}}}{1,3}$$

For the types **A33** and **A88** the following formula needs to be used:  
Therefore the values R<sub>1,k</sub> + power + R<sub>k,steel</sub> are stated in the table below.

$$R_{1,d} = \min \left( \frac{R_{1,k}}{(k_{\text{mod}})^{\text{power}}} \times \frac{k_{\text{mod}}}{1,3}; \frac{R_{k,\text{steel}}}{1,3} \right)$$

### Characteristic Capacities under horizontal load (F<sub>2/3</sub>)

For F<sub>2/3</sub>-horizontal force the following formula needs to be used:  
Therefore the values R<sub>2/3,k</sub> are stated in the table below.

$$R_{2/3,d} = R_{2/3,k} \times \frac{k_{\text{mod}}}{1,3}$$

### Characteristic Capacities under horizontal load (F<sub>4/5</sub>)

For F<sub>4/5</sub>-horizontal force the following formula needs to be used:  
Therefore the values for R<sub>4/5,k</sub> connected with 2 angle brackets and  
for R<sub>4,k</sub> / R<sub>5,k</sub> connected with 1 angle bracket are stated in the table below.

$$R_{4/5,d} = R_{4/5,k} \times \frac{k_{\text{mod}}}{1,3}$$

Supported Member with a minimum width b<sub>t</sub>=60mm.

The load capacities R<sub>4,k</sub> are splitted in with and without rotation of purlin.

**Table D55-3: Characteristic capacity beam to beam or post to beam (connection with one A-bracket)**

Model No.	R <sub>1,k</sub> (kN) Characteristic Capacities <sup>[1]</sup>			R <sub>k,steel</sub> (kN)	R <sub>2/3,k</sub> (kN) Characteristic Capacities <sup>[1]</sup>	
	N3.75x30	N3.75x75 <sup>[2]</sup>	power		N3.75x30	N3.75x75
A21	0,24	-	-	-	0,35	-
A23	0,48	-	-	-	1,09	-
A33	-	1,15	0,25	1,04	-	2,30
A88	-	0,57	1	0,57	-	2,16

[1] - Characteristic Capacities have been determined in accordance with EN14358 and are based on C24 timber

[2] - The Characteristic Capacities R<sub>1,k</sub> and R<sub>4/5,k</sub> connected with smooth shank nails N3.75x75 shall only be used for short load durations!

**Table D55-4: Characteristic capacity beam to beam or post to beam (connection with one A-bracket)**

Model No.	$R_{4,k}$ (kN) Characteristic Capacities <sup>[1]</sup>						$R_{5,k}$ (kN) Characteristic Capacities <sup>[1]</sup>			
	N3.75x30			N3.75x75 <sup>[2]</sup>			N3.75x30		N3.75x75 <sup>[2]</sup>	
	e [mm]	with rotation	without rotation	e [mm]	with rotation	without rotation	e [mm]	[kN]	e [mm]	[kN]
A21	50	0.066 / $k_{mod}$	0,92	-	-	-	50	0,23	-	-
	100	0.033 / $k_{mod}$		-	-	-	100	0,13	-	-
	150	0.022 / $k_{mod}$		-	-	-	150	0,08	-	-
A23	50	0.131 / $k_{mod}$	1,70	-	-	-	50	0,46	-	-
	100	0.066 / $k_{mod}$		-	-	-	100	0,25	-	-
	150	0.044 / $k_{mod}$		-	-	-	150	0,17	-	-
A33	-	-	-	50	0.28 / $k_{mod}$	2,00	-	-	50	1.0 / $k_{mod}^{0.5}$
	-	-	-	100	0.14 / $k_{mod}$		-	-	100	0,70
	-	-	-	150	0.10 / $k_{mod}$		-	-	150	0,47
A88	-	-	-	50	0,34	2,60	-	-	50	0.57 / $k_{mod}$
	-	-	-	100	0.20 / $k_{mod}$		-	-	100	0.55 / $k_{mod}^{0.5}$
	-	-	-	150	0.13 / $k_{mod}$		-	-	150	0,47

**Table D55-5: Characteristic capacity beam to beam or post to beam (connection with two A-brackets)**

Model No.	$R_{4/5,k}$ (kN) Characteristic Capacities <sup>[1]</sup>			
	N3.75x30		N3.75x75 <sup>[2]</sup>	
	e [mm]	[kN]	e [mm]	[kN]
A21	50	1,15	-	-
	100	1,05	-	-
	150	1,00	-	-
A23	50	2,15	-	-
	100	1,95	-	-
	150	1,85	-	-
A33	-	-	50	2,95
	-	-	100	2,70
	-	-	150	2,47
A88	-	-	50	3,20
	-	-	100	3,15
	-	-	150	3,10

**Annex D56 - ABR98**

Product Name	alternative names			
	UK	France	DK	D
ABR98				

**Figure D56-1: Drawings**

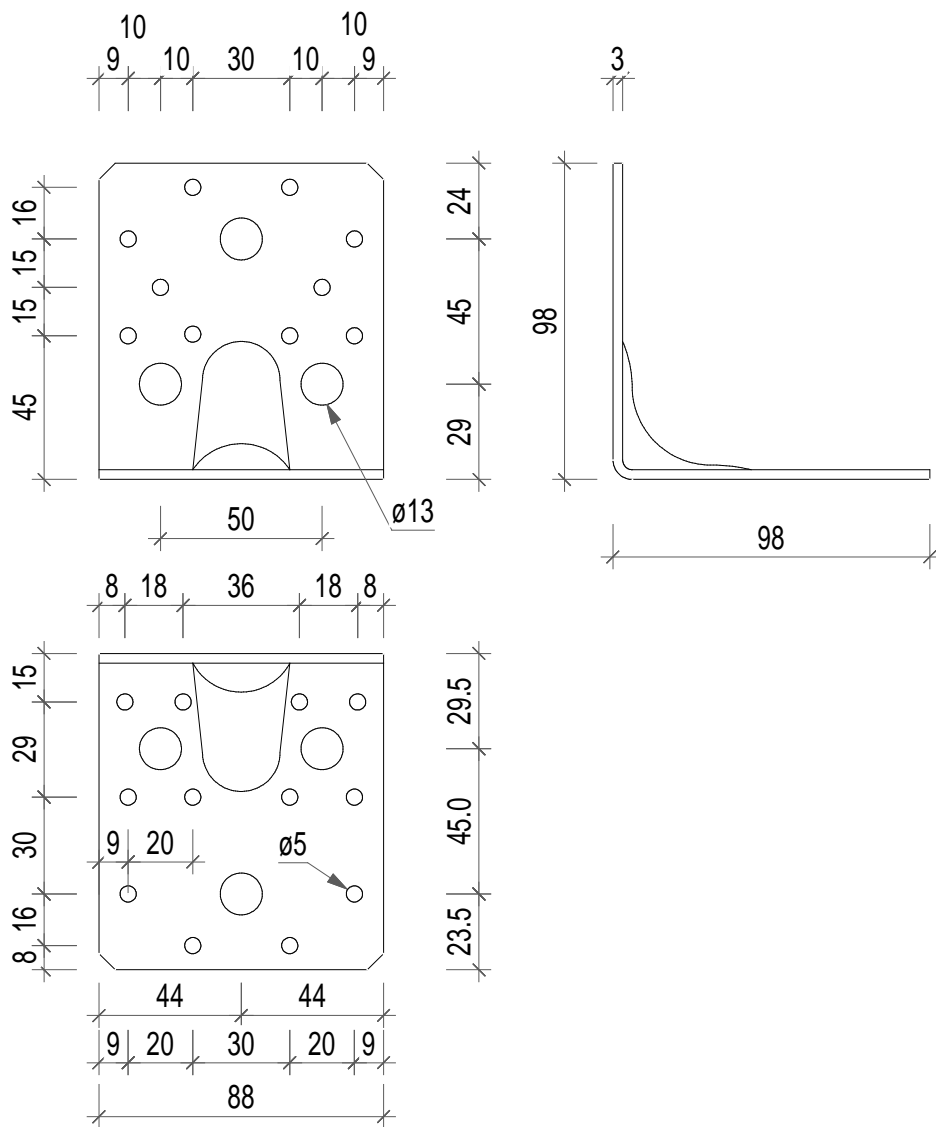

**Table D56-1: Material specification**

Material thickness	Material Grades	Coating specification
3	S250GD according to EN 10346:2009	Z275 according to EN10346:2009

Or stainless steel according to clause II-1

## Nail pattern

Beam to beam connection

full nailing

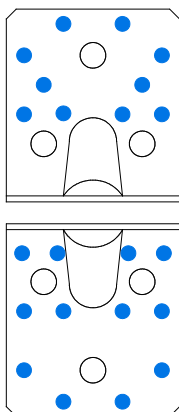

Figure D56-2  
10 in the vertical flap  
12 nails in the horizontal flap

partial nailing

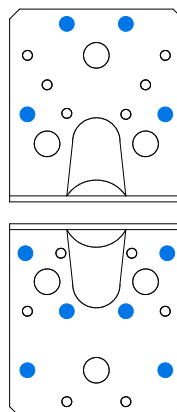

Figure D56-3  
4 in the vertical flap  
6 nails in the horizontal flap

**Table D56-2: Characteristic capacity beam to beam  $R_{2/3,k}$  (shear load)**

2 Angle Brackets ABR98 per connection	Characteristic capacity $R_{2/3,k}$ [kN]			
	connector nails according ETA-04/0013			
nailing	4,0x35	4,0x40	4,0x50	4,0x60
partial nailing: vertical 4 nails + horizontal 6 nails see fig D56-3	6,01	6,87	8,82	9,70
full nailing: vertical 10 nails + horizontal 12 nails see fig D56-2	12,11	13,73	17,52	19,83

Other fasteners may be used using the following formula and factors from table D56-3. Alternatively the values from previous tables can be reduced accordingly:

$$R_{2/3,k} = \min \left\{ \sqrt{\frac{1}{\left(\frac{1}{k_{lat,v} \times R_{lat,k}}\right)^2 + \left(\frac{1}{k_{ax,v} \times R_{ax,k}}\right)^2}}, \sqrt{\frac{1}{\left(\frac{1}{k_{lat,h} \times R_{lat,k}}\right)^2 + \left(\frac{1}{k_{ax,h} \times R_{ax,k}}\right)^2}} \right.$$

**Table D56-3: factors**

factors	for	
	partial nailing	full nailing
$k_{lat,v}$	2,1	4,3
$k_{ax,v}$	41,3	30,7
$k_{lat,h}$	2,9	5,4
$k_{ax,h}$	6,2	13,3

**Annex D57 - AB105/513**

Product Name	alternative names			
	UK	France	DK	D
AB105/513				

**Figure D57-1: Drawings**

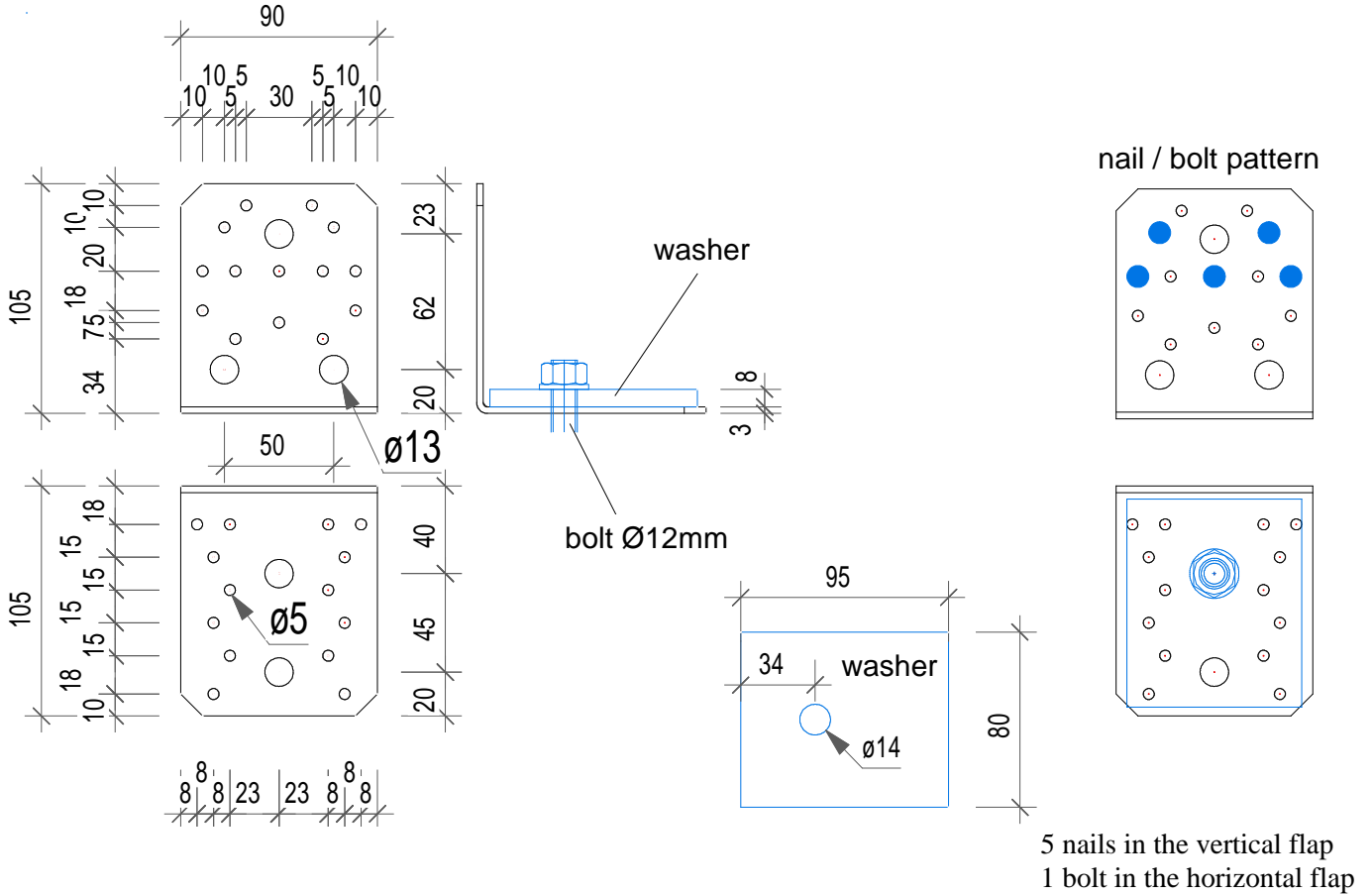

5 nails in the vertical flap  
1 bolt in the horizontal flap

**Table D57-1: Material specification**

Material thickness	Material Grades	Coating specification
3	S250GD according to EN 10346:2009	Z275 according to EN10346:2009

Or stainless steel according to clause II-1

The washer with  $t \geq 8\text{mm}$  has to fulfill the minimum requirement: steel with  $f_{y,k} \geq 235 \text{ N/mm}^2$

**Table D57-2: Characteristic capacity beam to rigid support**

load direction	fixing	Installation *	characteristic capacity $R_{1,k}$ [kN]	
			min. von	
$F_1$	5 nails $\varnothing 4,0$ or 5 CSA5,0x $\ell$ 1 bolt $\varnothing 12\text{mm}$	normal	$n \times R_{lat,k}$	$10,1/k_{mod}$
		special	$n \times R_{lat,k} \times 0,8$	$10,1/k_{mod}$

\*Installation:

Normal = with retention of the spacing of nails according EN1995-1-1

Special = with smaller spacing of the nails according to the picture below.

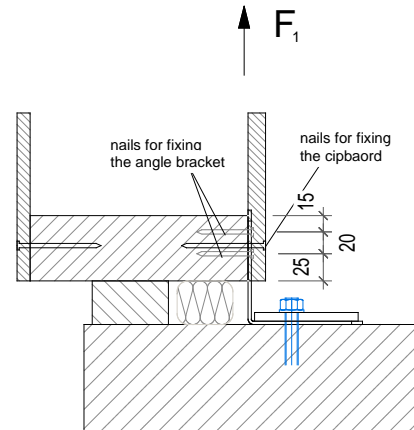

With:

$n$  = number of nails

$R_{lat,k}$  = characteristic lateral Load-carrying capacity of one connector nail/screw

It is to check additionally for the anchorage:  $R_{bolt,ax,d} \geq F_{1,d} \times 1,47$

With:  $R_{bolt,ax,d}$  = the axial design capacity of the anchor / bolt