



ARES2

Montageanleitung



1

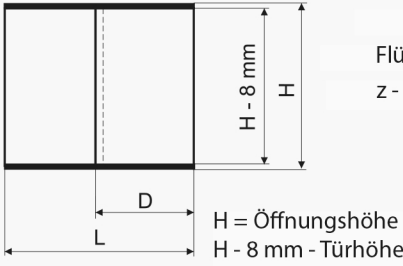

$$\text{Tür breite } D = \frac{L + (n-1) \cdot z}{n}$$

Flügel Mengen = 2,3,4....

z - Überlappung, 40 mm

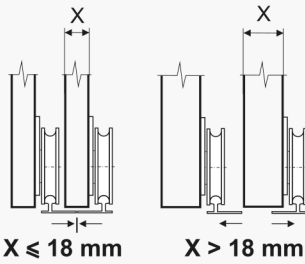
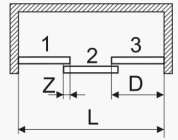

2 A

2 B

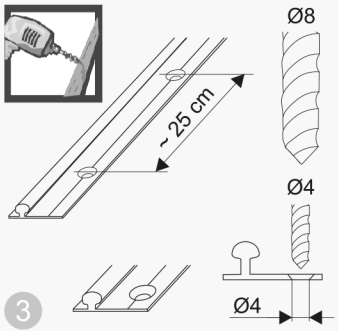

3

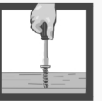

Ø3,5x16

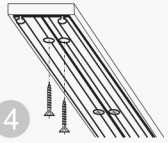

4



Ø4x16

5

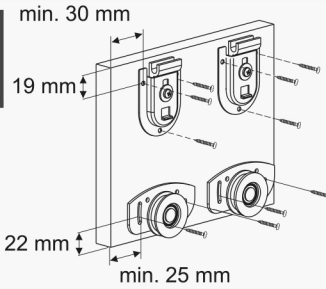

6

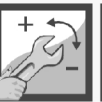
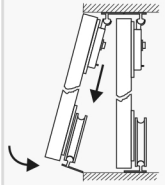

7

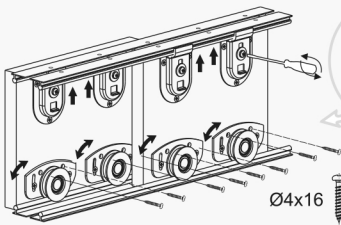

8

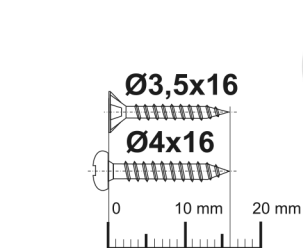
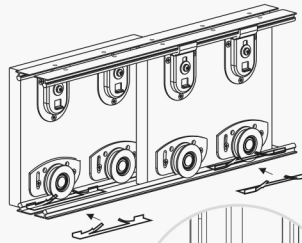
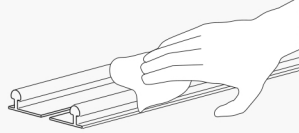

1:1