

Puerta LANKA

INSTRUCCIONES DE MONTAJE

FUTUR BAÑO
Bath feelings

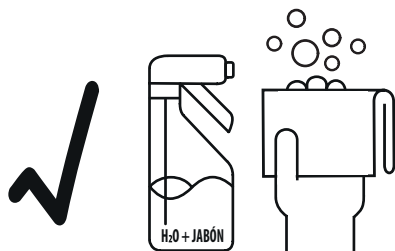

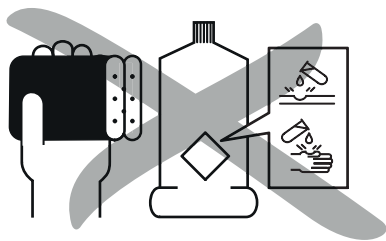







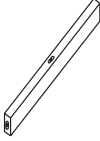







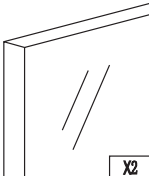

NOTA IMPORTANTE_ LIMPIEZA DE LA PUERTA

Limpe su puerta siempre con jabones neutros y agua.
Otro tipo de productos pueden dañar serigrafías, gomas de estanqueidad, perfiles e incluso los tratamientos anti-cal de los cristales en caso de llevarlos.
Limpiar siempre las piezas metálicas con un paño suave, no utilizar estropajos, provocaría arañazos.

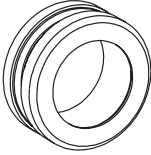
HERRAMIENTAS NECESARIAS

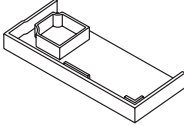
			
			
A  X6	B  X4	C  X2	D  X1
E  X2	F  X2	G  X2	H  X1
I  X1	J  X1		
K  X2			

Puerta LANKA

MONTAJE

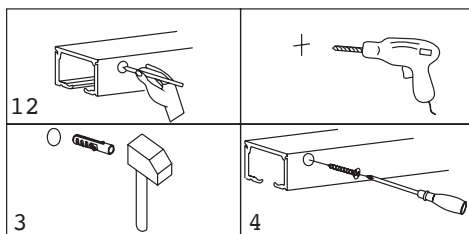
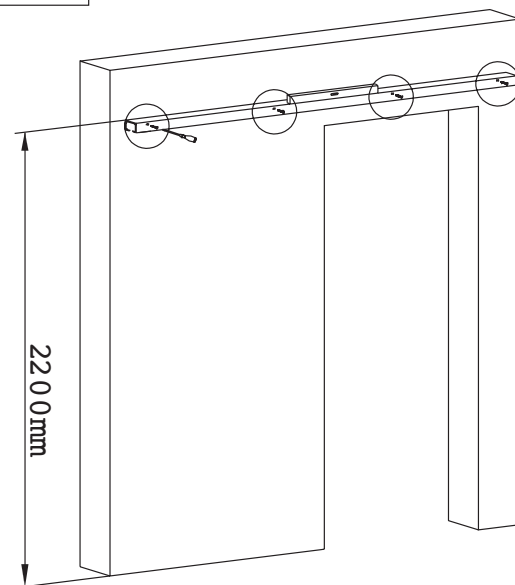
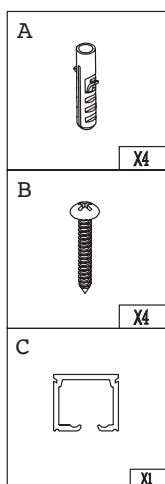
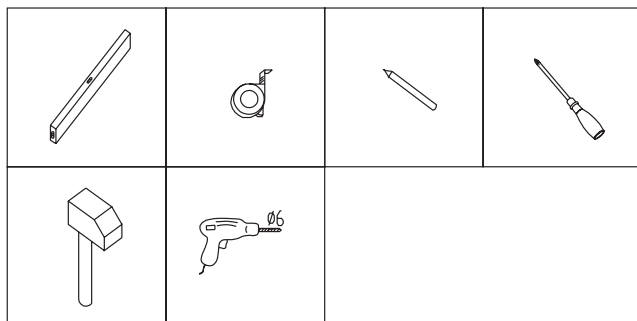

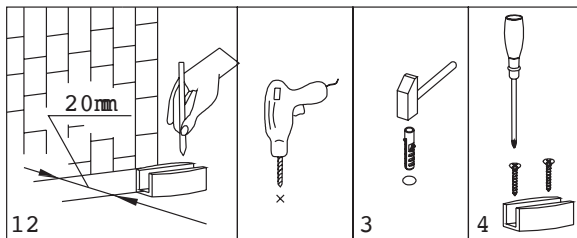
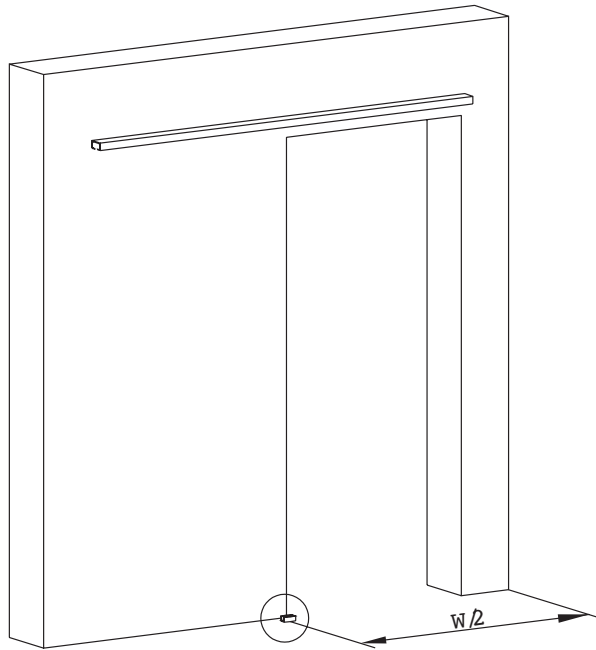
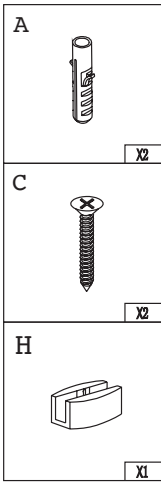
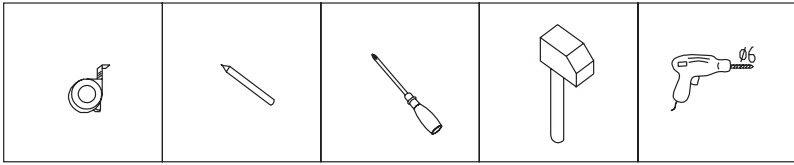

Puerta LANKA

MONTAJE

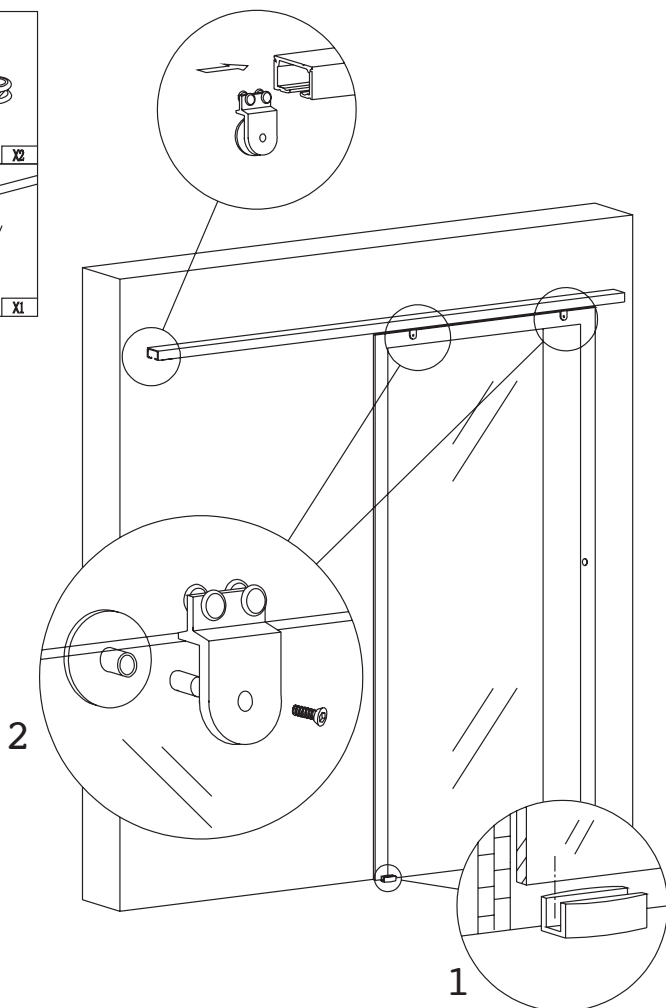
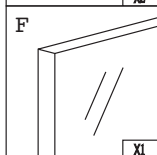
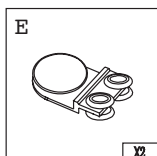
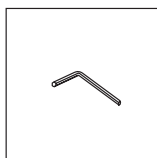

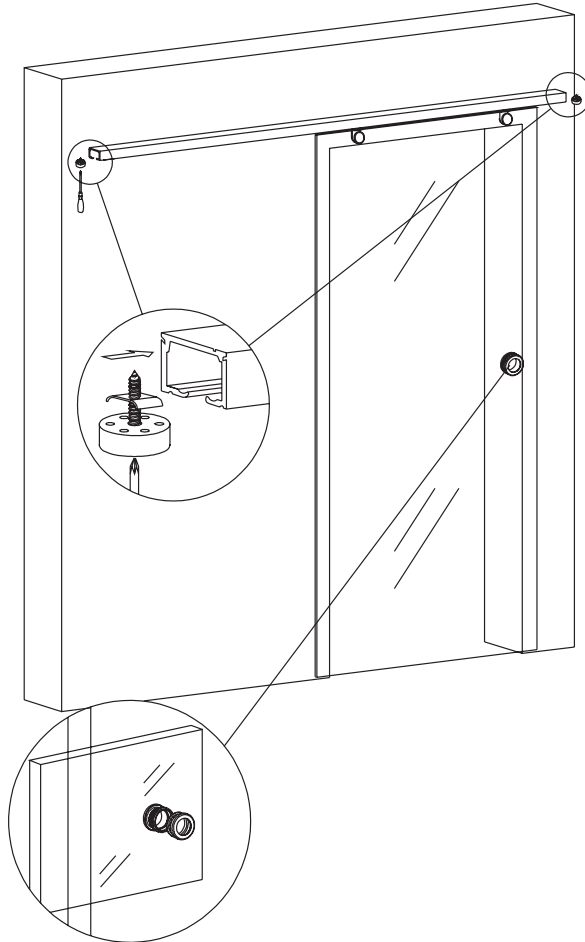
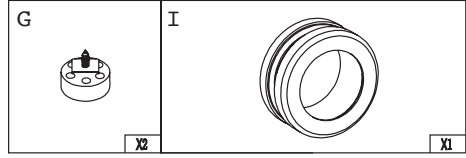
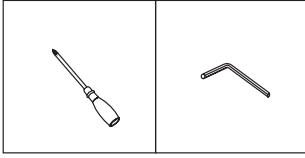

Puerta LANKA

MONTAJE

