

# Service

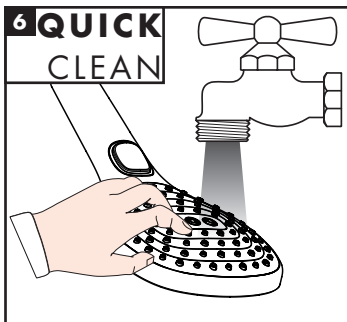
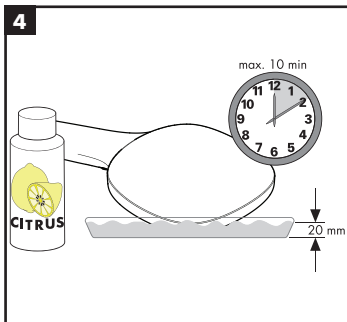
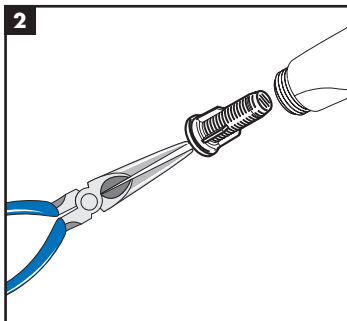
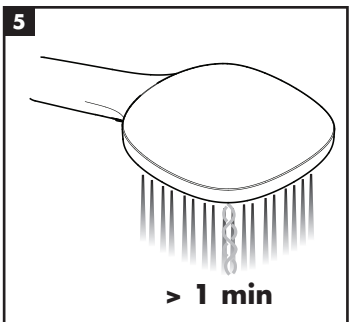
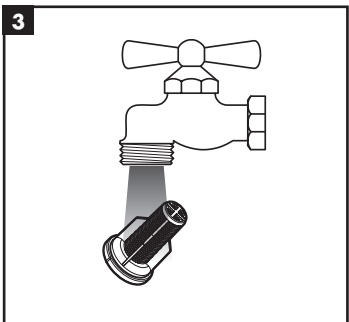
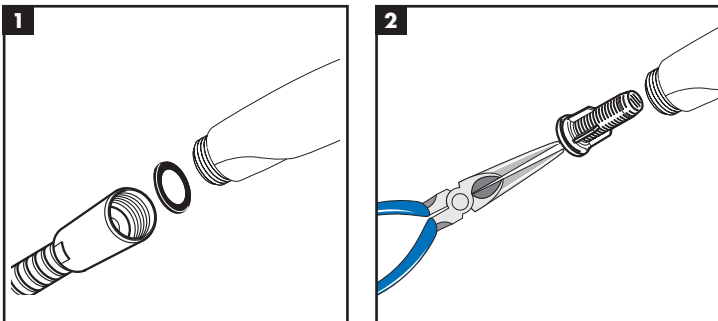

5

**DE** Einfach sauber: Kalk lässt sich von den Noppen ganz leicht abrubeln.

**FR** La propreté en toute simplicité: les dépôts formés sur les buses élastiques en silicone s'éliminent par un simple passage de la main.

**EN** Just clean: simply rub over the spray nozzles to remove lime scale.

**IT** Facile da pulire: Il calcare viene eliminato semplicemente dagli ugelli elastici in silicone.

**ES** Fácil aseo: La cal se puede retirar sencillamente frotando con los dedos de las toberas elásticas de silicona.

**NL** Eenvoudig schoon: Kalk kan eenvoudig van de noppen worden gewreven.

**DK** Enkel rengøring: Det er let at fjerne kalkaflejringer fra stråledyserne.

**PT** Simplesmente limpo: o calcário pode ser simplesmente retirado das saliências através de fricção.

**PL** Po prostu czysto: Pęczki można całkiem łatwo oczyścić z kamienia.

**CS** Jednoduše čistě: Vapenné usazeniny můžete z nopků snadno odstranit třením.

**SK** Jednoduchou čistý: Vodný kameň sa dá zo štetín celkom ľahko odstrániť.

**ZH** 清洁: 只需要揉搓花洒表面的出水孔即可去除水垢。

**RU** Простота чистки: известь очень легко стирается с утолщений.

**HU** Egyszerűen tisztá: a vízkő egészen könnyen ledörzsölhető a csomókról.

**FI** Yksinkertaisesti puhdas: kalkin voi helposti hieroa irti nyyplistä.

**SV** Enkelt att göra rent: det är lätt att ta bort kalk från nopporna.

**LT** Paprasta švara: kalkės lengvai nugrandomos nuo kilpos.

**HR** Jednostavno čisto: Kamenac se sasvim lako uklanja s izbočina.

**TR** Sadece temiz: Kireç, düğümlerle kolayca ovalanabilir.

**RO** Pur și simplu curat: Calcarul se îndepărtează ușor de pe noduri prin frecare.

**EL** Απλά τέλεια καθαριότητα: Τα άλατα μπορούν να αφαιρεθούν με μεγάλη ευκολία από τα στόμια.

**SL** Preprosto čisto: apnenec se z lahkoto podrgne z vozličkov.

**ET** Lihtsalt puhas: lujja saab nappude lihtsalt maha hõõruda.

**LV** Vienkārši tīrāna: kalkis no izvirzījumiem ir viegli norubināms.

**SR** Jednostavno čisto: Kamenac se sasvim lako skida sa izbočina.

**NO** Simpelten ren: Ved å gnikke er det lett å fjerne kalk fra nuppene.

**BG** Просто чисто: Варовикът лесно може да се изтреси от удебеленията.

**SQ** Thjesht dhe pastër. Mbetjet gëlqerore mund të hiqen me fërkim të lehtë.

**AR** إنه سهل التنظيف، حيث يسقط الجير بسهولة شديدة من الأجزاء الناتئة.

## hansgrohe

Hansgrohe · Austraße 5 · 9 · D-77761 Schiltach  
 Telefon +49 (0) 78 36/51-1282 · Telefax +49 (0) 7836/511440  
 E-Mail: info@hansgrohe.com · Internet: www.hansgrohe.com

05/2019  
 9.02080.06

# hansgrohe

**DE** Montageanleitung

**FR** Instructions de montage

**EN** assembly instructions

**IT** Istruzioni per Installazione

**ES** Instrucciones de montaje

**NL** Handleiding

**DK** Monteringsvejledning

**PT** Manual de Instalação

**PL** Instrukcja montażu

**CS** Montážní návod

**SK** Montážny návod

**ZH** 组装说明

**RU** Инструкция по монтажу

**HU** Szerelési útmutató

**FI** Asennusohje

**SV** Monteringsanvisning

**LT** Montavimo instrukcijos

**HR** Uputstva za instalaciju

**TR** Montaj kılavuzu

**RO** Instrucțiuni de montare

**EL** Οδηγία συναρμολόγησης

**SL** Navodila za montažo

**ET** Paigaldusjuhend

**LV** Montāžas instrukcija

**SR** Uputstvo za montažu

**NO** Montasjeveiledning

**BG** Инструкция за употреба

**SQ** Udhëzime rreth montimit

**AR** تعليمات التجميع

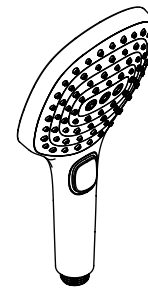

**Raindance Select E 120**  
26520XXX

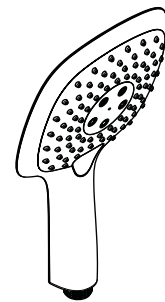

**Raindance Select E 150**  
26550XXX

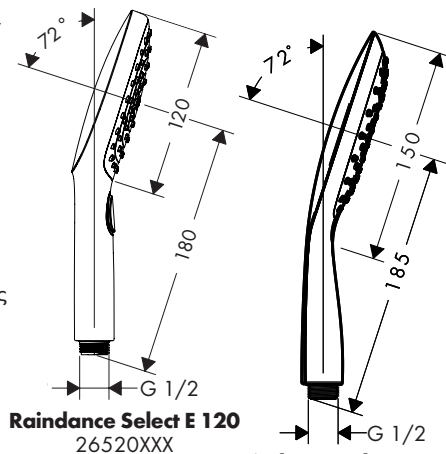

**Raindance Select E 120**  
26520XXX

**Raindance Select E 150**  
26550XXX

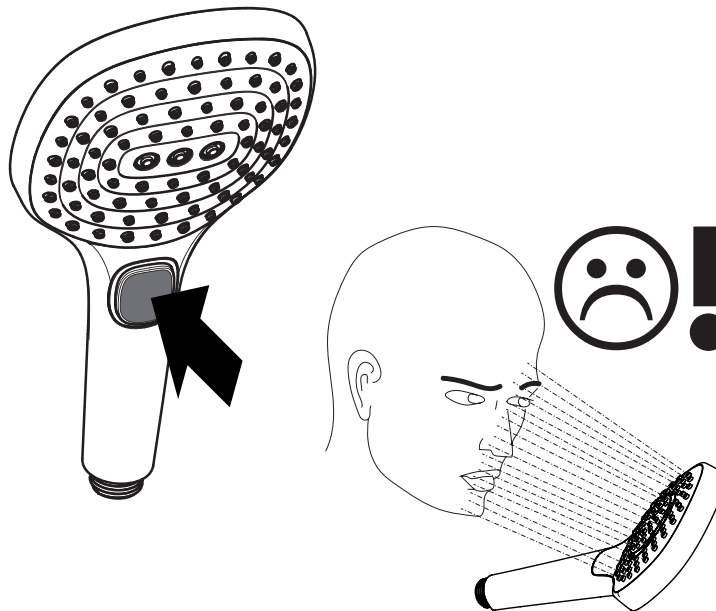
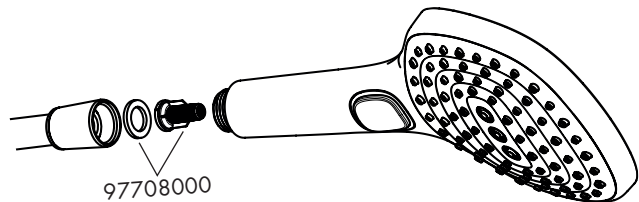
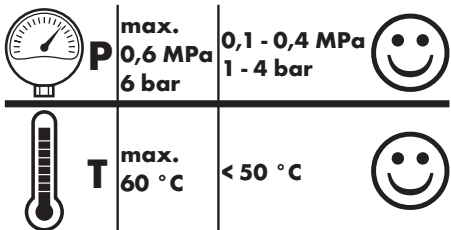

**Raindance Select E 120**  
26520XXX

**Raindance Select E 150**  
26550XXX

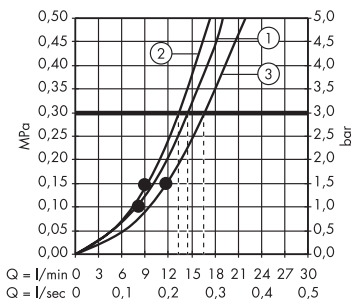
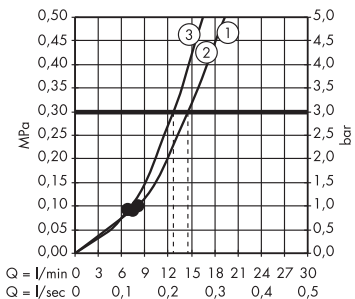

2

	P-IX	DVGW	NF
<b>26520XXX</b>	P-IX 28001/IB	CO0505	X
<b>26550XXX</b>	P-IX 19142/IB		X

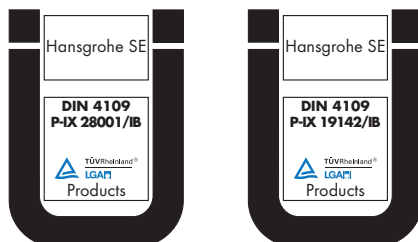

3

- DE** Reinigungsempfehlung / Garantie / Kontakt
- FR** Recommandation pour le nettoyage / Garanties / Contact
- EN** Cleaning recommendation / Warranty / Contact
- IT** Raccomandazione di pulizia / Garanzia / Contatto
- ES** Recomendaciones para la limpieza / Garantía / Contacto
- NL** Aanbevelingen inzake reiniging / Garantie / Contact
- DK** Rensning, anbefaling / Garanti / Kontakt
- PT** Recomendações de limpeza / Garantia / Contacto
- PL** Zalecenie dotyczące pielęgnacji / Gwarancja / Kontakt
- CS** Doporučení k čištění / Záruka / Kontakt
- SK** Odporúčania pre čistenie / Záruka / Kontakt
- ZH** 清洁指南 / 担保 / 接触
- RU** Рекомендации по очистке / Гарантия / Контакты
- HU** Tisztítási tanácsok / Garancia / érintkezés
- FI** Puhdistussuositus / Takuu / Kosketus
- SV** Rengöringsrekommendationer / Garanti / Contacto
- LT** Valymo rekomendacijos / Garantija / Kontaktai
- HR** Preporuke za čišćenje / Garancija / Kontakt
- TR** Temizleme önerisi / Garanti / Temas
- RO** Recomandări pentru curățare / Garanție / Contact
- EL** Σύσταση καθαρισμού / Εγγύηση / επαφή
- SL** Priporočilo za čiščenje / Garancija / Kontakt
- ET** Puhastussuovitused / Garantii / Kontakt
- LV** Tīrīšanas ieteikumi / Garantija / Kontakti
- SR** Preporuke za čišćenje / Garancija / Kontakt
- NO** Anbefaling for rengjøring / Garanti / Kontakt
- BG** Препоръка за почистване / Гаранция / Контакт
- SQ** Këshilla rreth pastrimit / Garancia / Kontakt
- KO** 세정시 권장사항 / 품질보증 / 접촉
- AR** توصيات التنظيف / الضمان (الولايات المتحدة الأمريكية) / اتصال



[www.hansgrohe.com/cleaning-recommendation](http://www.hansgrohe.com/cleaning-recommendation)

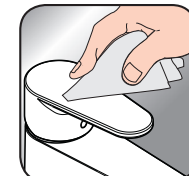

[www.hansgrohe.com/cleaning-recommendation](http://www.hansgrohe.com/cleaning-recommendation)



[www.hansgrohe.com/cleaning-recommendation](http://www.hansgrohe.com/cleaning-recommendation)



[www.hansgrohe.com/cleaning-recommendation](http://www.hansgrohe.com/cleaning-recommendation)

4