

HANSABLUEBOX

INSTALLATION AND MAINTENANCE GUIDE

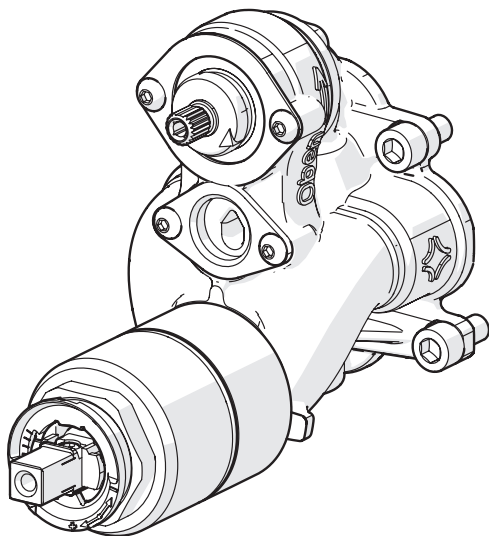

Contents

| | | | |
|-------------------------------|----------------------------|-----------------------|--------------------------------|
| CZ Obsah | FI Sisällysluettelo | IT Indice | PT Conteúdo |
| DE Inhaltsübersicht | FR Sommaire | NL Inhoud | RU Содержание |
| DK Indholdsfortegnelse | GR Περιεχόμενα | NO Innhold | SE Innehållsförteckning |
| ES Contenidos | HU Tartalom | PL Spis treści | SK Obsah |



| | |
|---------------------|-------|
| Technical data..... | 4 |
| Installation | 5-9 |
| Operation..... | 11 |
| Service..... | 12-15 |



| | |
|---------------------|---------|
| Technical data..... | 4 |
| Installation | 5-8, 10 |
| Operation..... | 11 |
| Service..... | 12-15 |

| | |
|------------------------|----|
| Spare parts | 16 |
| Extension set | 16 |
| Reverse adapter..... | 16 |
| Distance adapter | 17 |
| Bluetune kit..... | 18 |



Technical data

CZ Technická data

FI Tekniset tiedot

IT Dati tecnici

PT Dados técnicos

DE Technische Daten

FR Données techniques

NL Technische gegevens

RU Технические данные

DK Tekniske data

GR Τεχνικά στοιχεία

NO Teknisk informasjon

SE Teknisk information

ES Datos técnicos

HU Műszaki adatok

PL Dane techniczne

SK Technické údaje

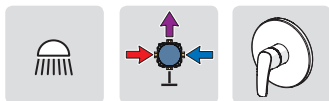

EN 817

I (ISO 3822)

100 - 1000 kPa

max. +90°C

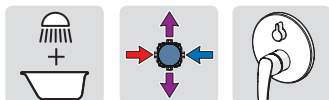
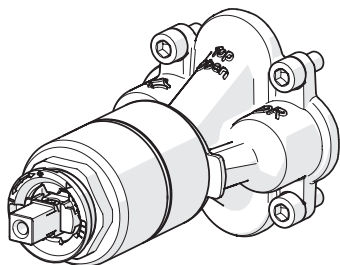

EN 817

I (ISO 3822)

100 - 1000 kPa

max. +90°C

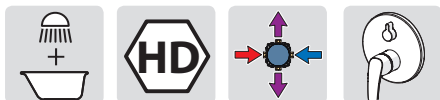
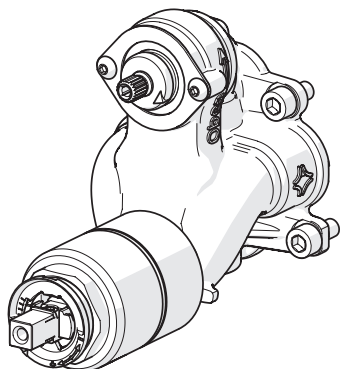

EN 817

I (ISO 3822)

100 - 1000 kPa

max. +90°C

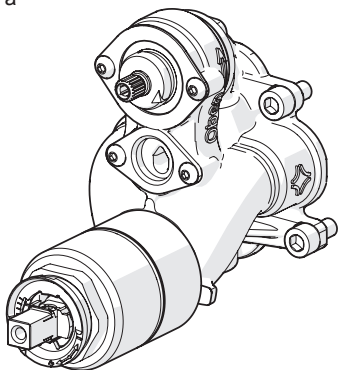

Rinsing

CZ Vypláchnutí

DE Spülen

DK Gennemskyldning

ES Aclarar

GR Έκπλυση

HU Öblítés

FI Huuhtelu

FR Rinçage

IT Spurgo

NL Spoelen

NO Rengjøring

PL Płukania

PT Enxaguamento

RU Промывка

SE Renspolning

SK Vypláchnutie

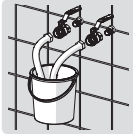
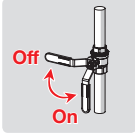

EN 1717
EN 806-5

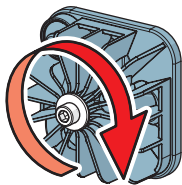

90°

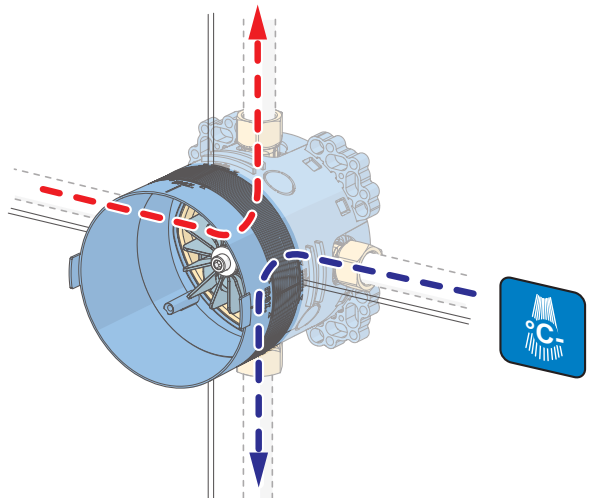
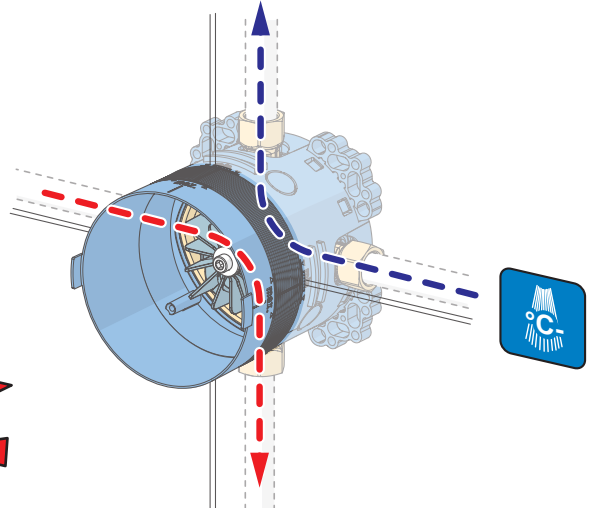
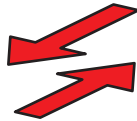

59 914 185

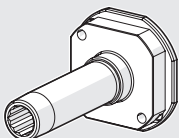

Rinsing tube

Installation

CZ Montáž

DE Montage

DK Installation

ES Montaje

FI Asennus

FR Installation

GR Συναρμολόγηση

HU Szerelés

IT Montaggio

NL Installatie

NO Montering

PL Instalacja

PT Instruções

RU Установка

SE Installation

SK Inštalácia

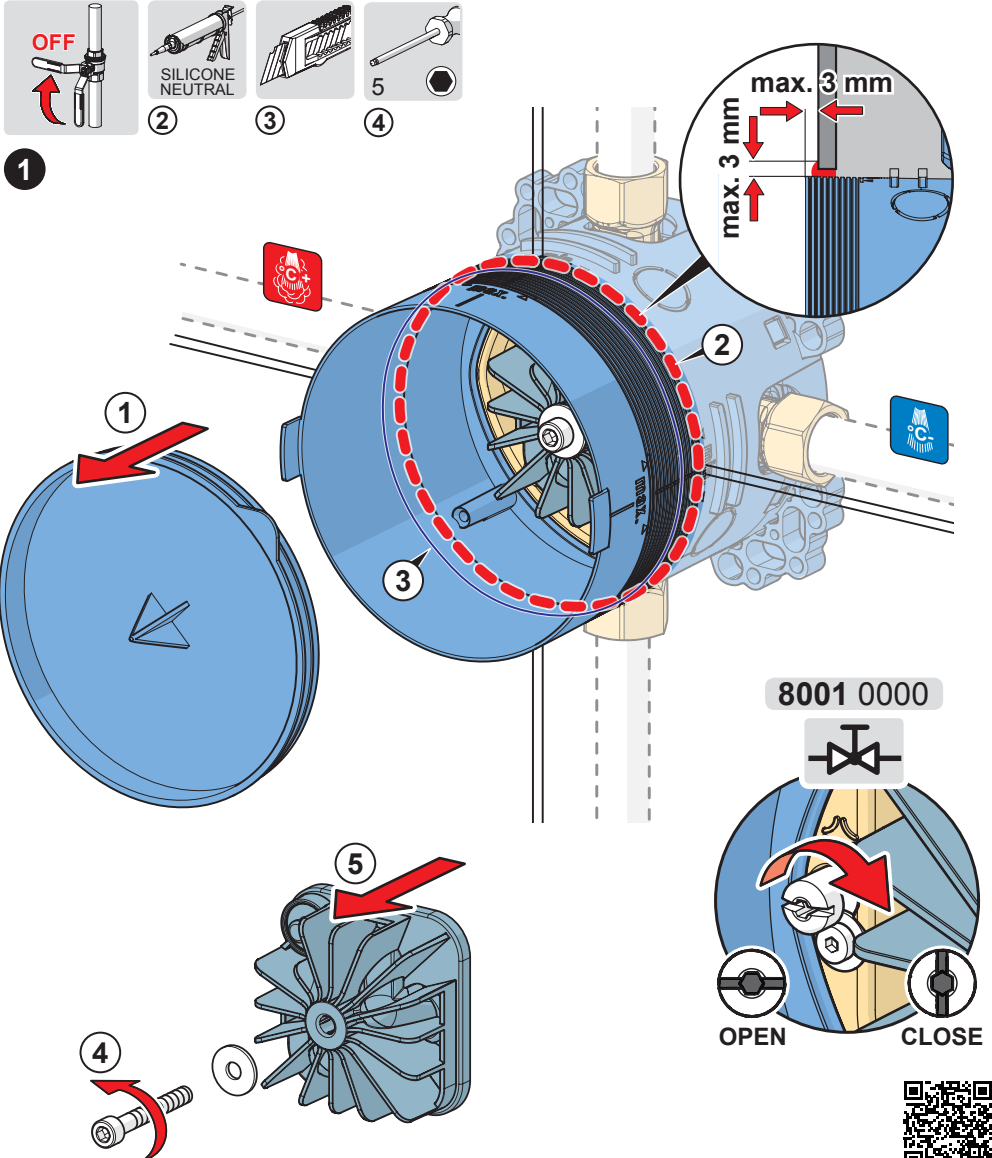

http://movie.hansa.com/blbx_assembly

Installation

CZ Montáž

DE Montage

DK Installation

ES Montaje

FI Asennus

FR Installation

GR Συναρμολόγηση

HU Szerelés

IT Montaggio

NL Installatie

NO Monterings

PL Instalacja

PT Instruções

RU Установка

SE Installation

SK Inštalácia

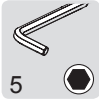

5
②

②

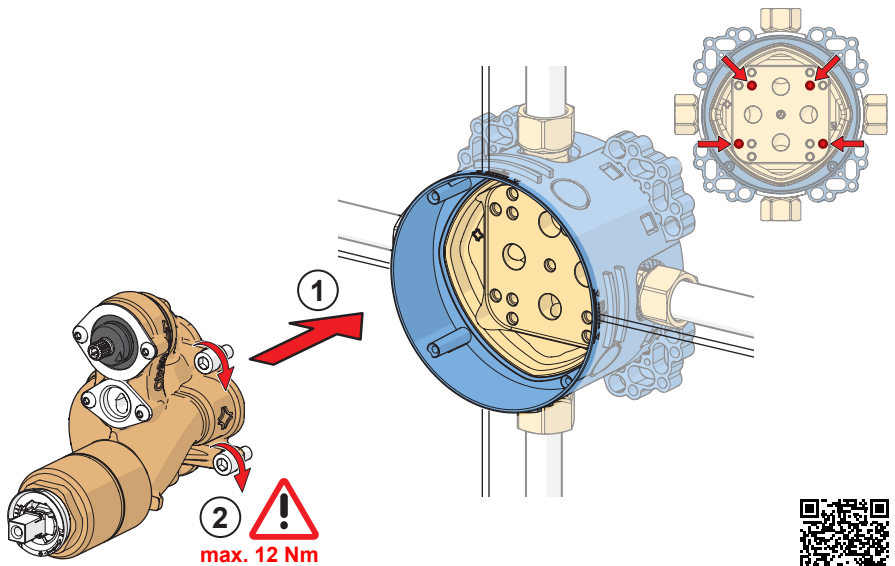
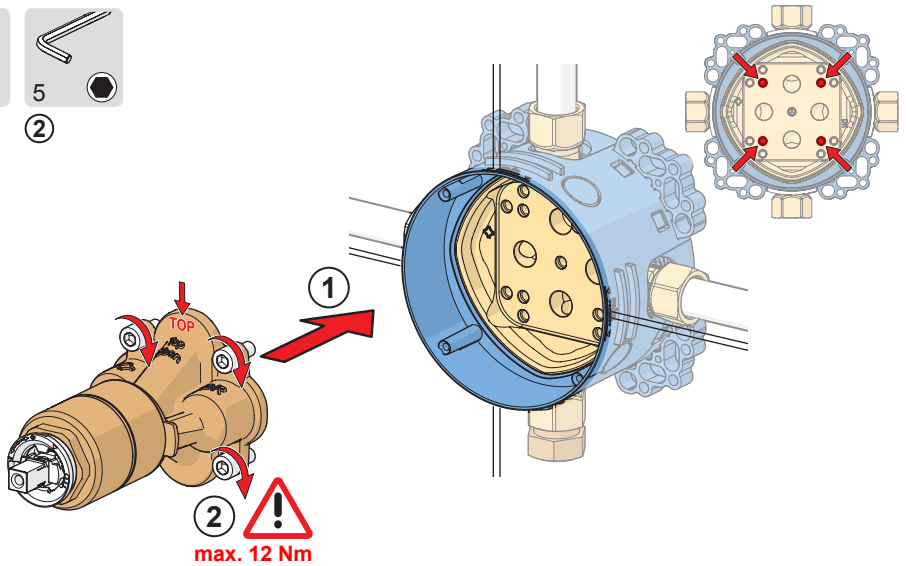

Installation

CZ Montáž

DE Montage

DK Installation

ES Montaje

FI Asennus

FR Installation

GR Συναρμολόγηση

HU Szerelés

IT Montaggio

NL Installatie

NO Montering

PL Instalacja

PT Instruções

RU Установка

SE Installation

SK Inštalácia

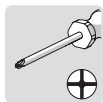

5

3

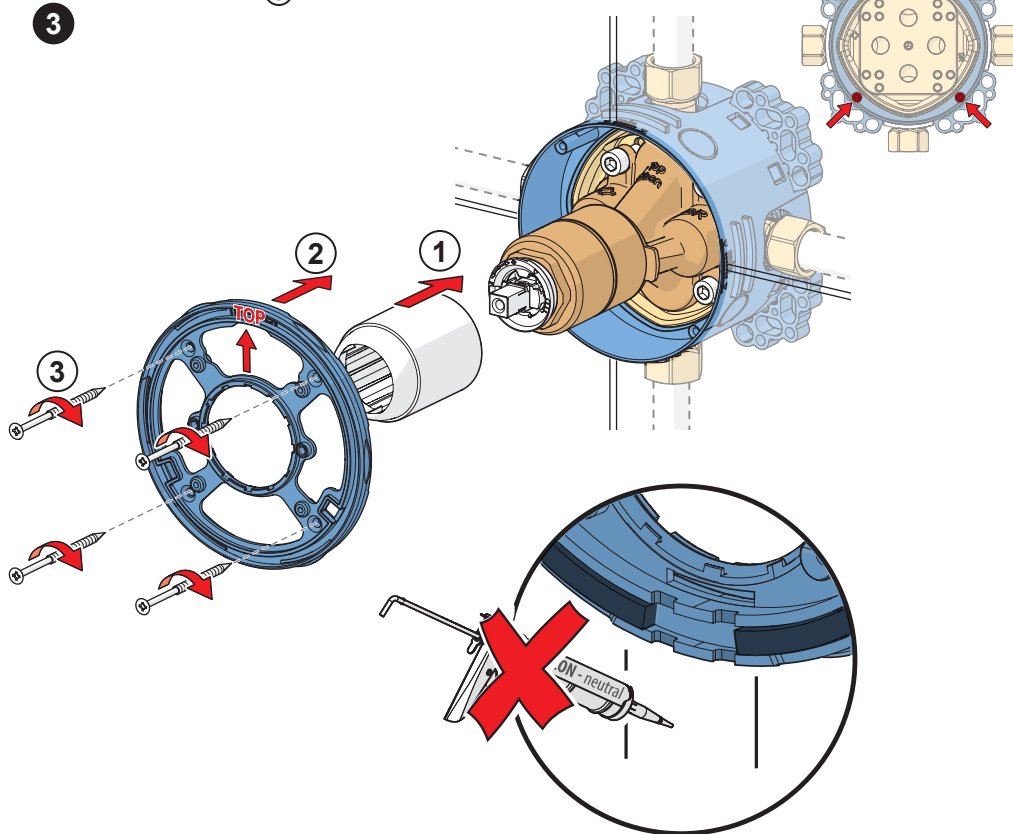

Installation

CZ Montáž

DE Montage

DK Installation

ES Montaje

FI Asennus

FR Installation

GR Συναρμολόγηση

HU Szerelés

IT Montaggio

NL Installatie

NO Montering

PL Instalacja

PT Instruções

RU Установка

SE Installation

SK Inštalácia

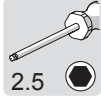

③

④

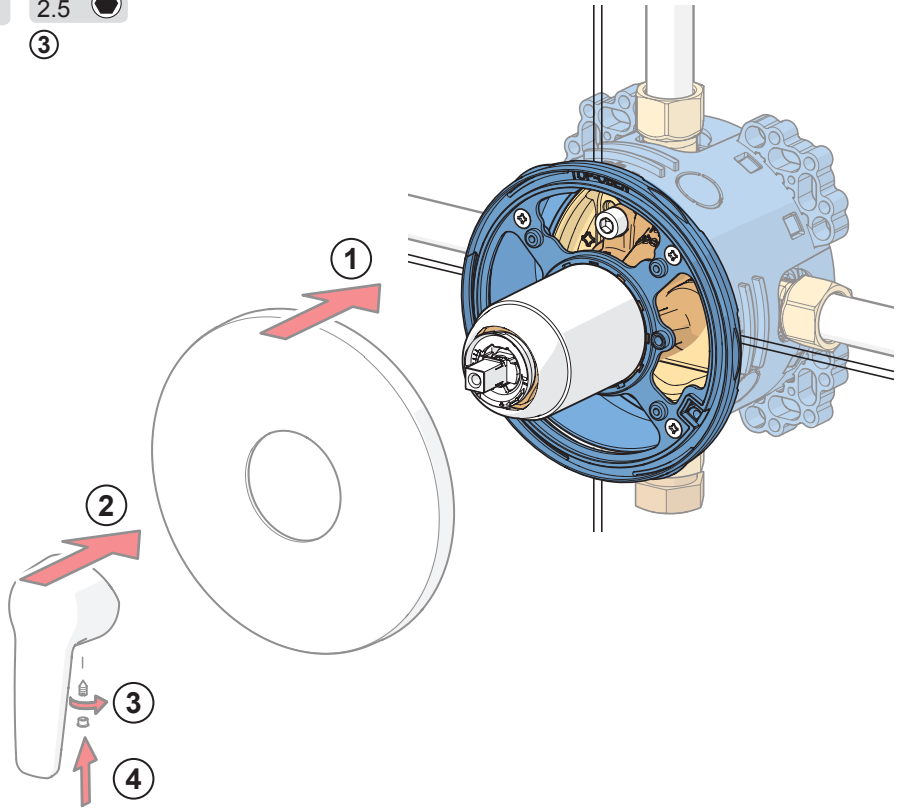

Installation

CZ Montáž

DE Montage

DK Installation

ES Montaje

FI Asennus

FR Installation

GR Συναρμολόγηση

HU Szerelés

IT Montaggio

NL Installatie

NO Montering

PL Instalacja

PT Instruções

RU Установка

SE Installation

SK Inštalácia

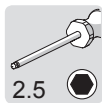

⑤

5

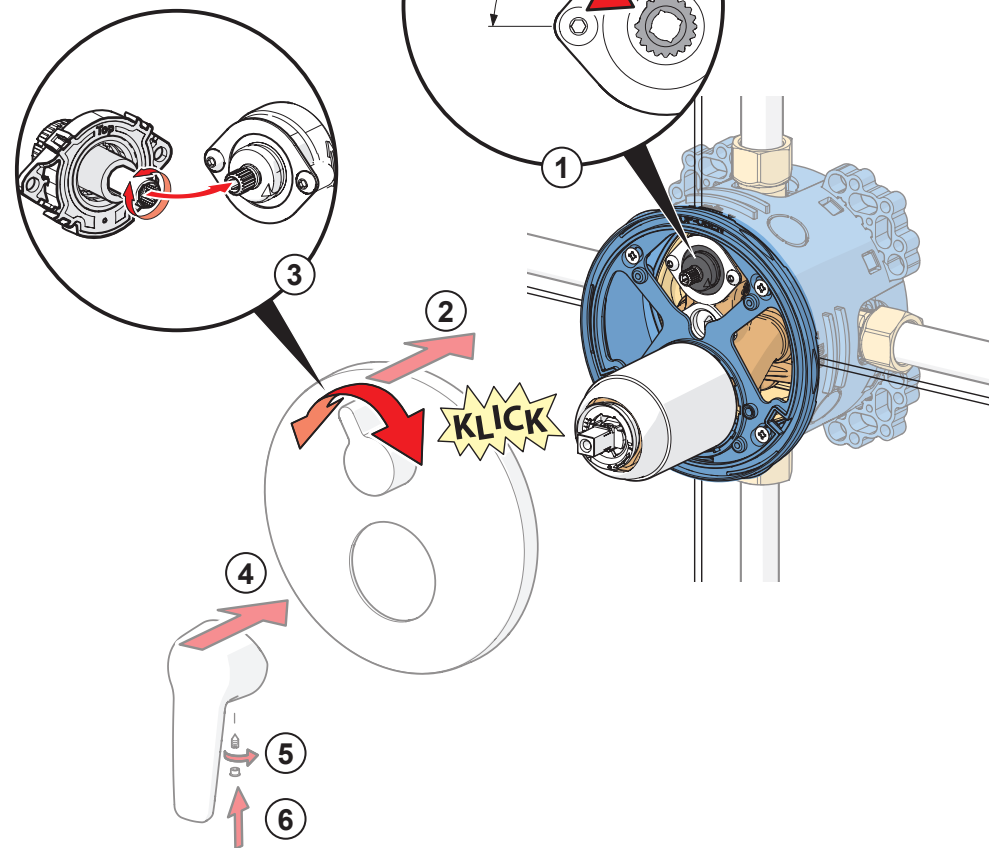

http://movie.hansa.com/bibx_assembly

Operation

CZ Funkce
DE Funktion
DK Betjening
ES Servicio

FI Toiminta
FR Utilisation
GR Λειτουργία
HU Üzemeltetés

IT Funzionamento
NL Bediening
NO Funksjon
PL Działanie

PT Funcionamento
RU Принцип действия
SE Funktion
SK Prevádzka

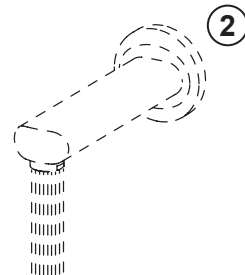
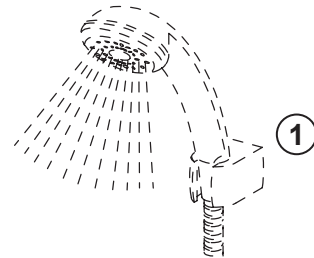
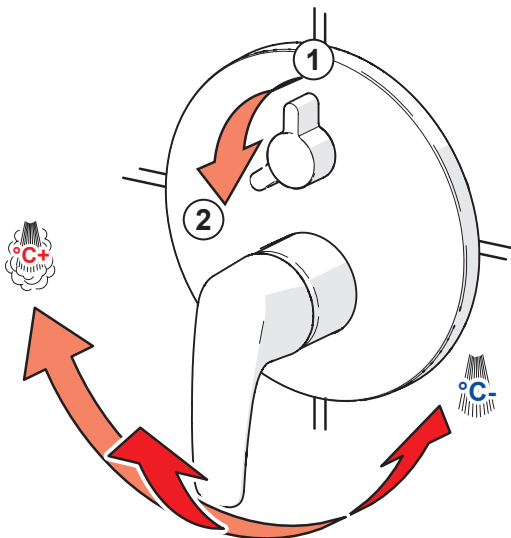
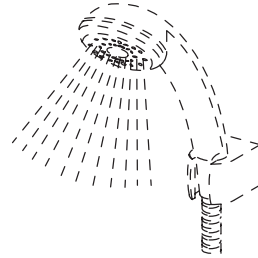
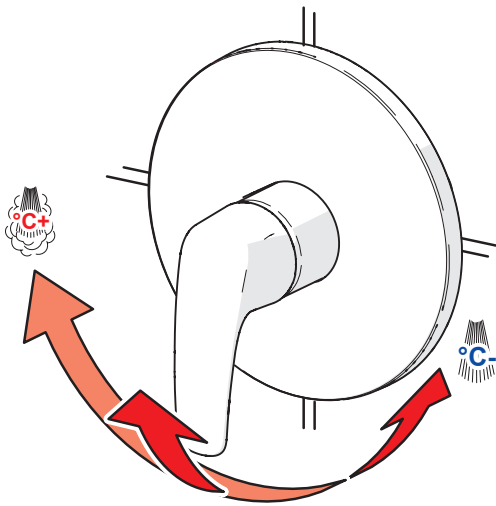

To change the cartridge

CZ Výměna kartuše

DE Auswechseln der Patrone

DK Udskiftning af reguleringskassette (unit)

ES Montaje del cartucho

FI Säätöosan vaihto

FR Montage et démontage de la cartouche

GR Αντικατάσταση του στοιχείου

HU A patron cseréje

IT Montaggio della cartuccia

NL Vervangen van het keramische binnenwerk

NO Skifting av kassett

PL Wymiana modułu sterującego

PT Substituição do cartucho

RU Замена регулировочного блока

SE Byte av kassett

SK Výměna kartuše

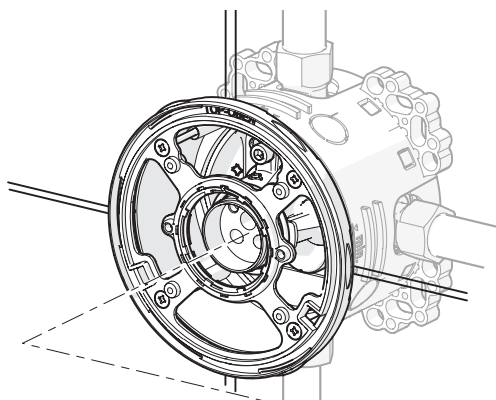
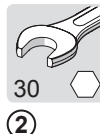
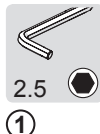
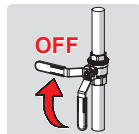

59 913 075

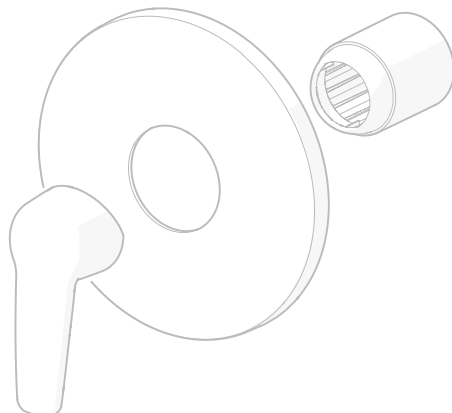
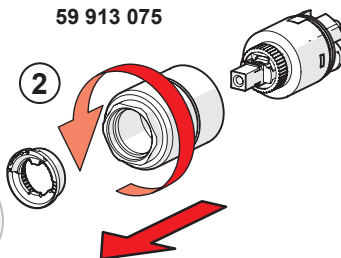

Limiting temperature

CZ Omezení teploty vody

DE Temperaturbegrenzung

DK Forindstilling af vandets max. temperatur

ES Limitación de la temperatura

FI Lämpötilan rajoitus

FR Limitation de la température

GR Περιορισμός θερμοκρασίας

HU A hőmérséklet határolása

IT Limitazione della temperatura

NL Perlator vervangent

NO Begrenzing temperatur

PL Ograniczenie temperatury

PT Limitar a temperatura

RU Ограничение температуры в регулирующем блоке

SE Begränsning av vattnets max. temperatur

SK Obmedzenie teploty

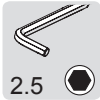

2.5

①

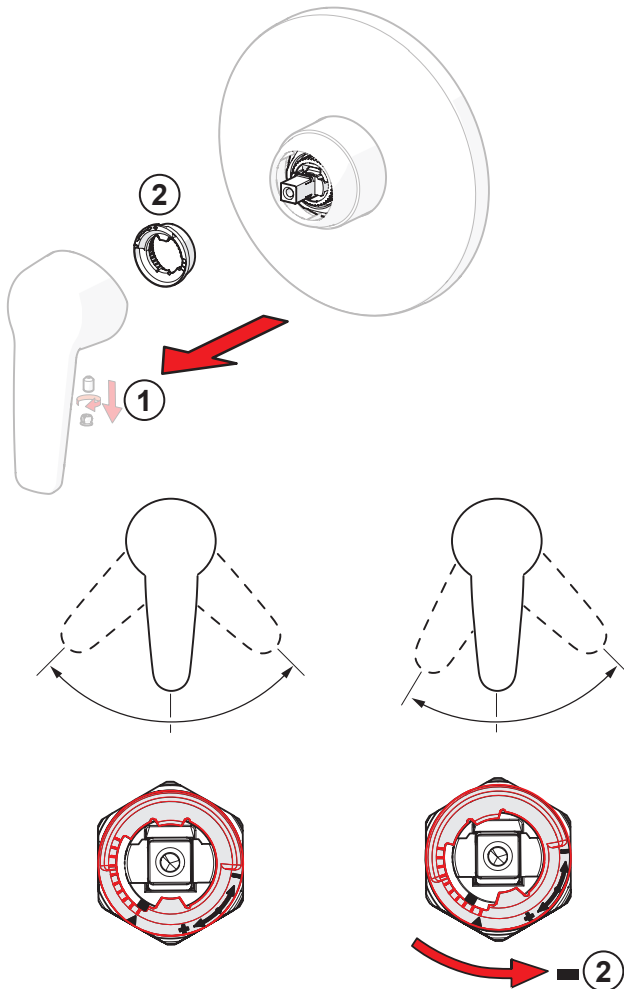

Limiting the flow rate

CZ Omezení průtoku

DE Bergenzung der Durchflußmenge

DK Begrænsning af vandmængden

ES Limitación de la tasa de flujo

FI Virtaaman rajoitus

FR Limitation du débit

GR Περιορισμός ρυθμού ροής

HU Az áramlás határolása

IT Limitazione della portata

NL Begrenzing van de doorstroomhoeveelheid

NO Begrensning av vannmengde

PL Ograniczenie wielkości strumienia

PT Limitar o caudal

RU Регулирование потока

SE Flödesbegränsning

SK Obmedzenie prietoku

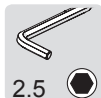

① ②

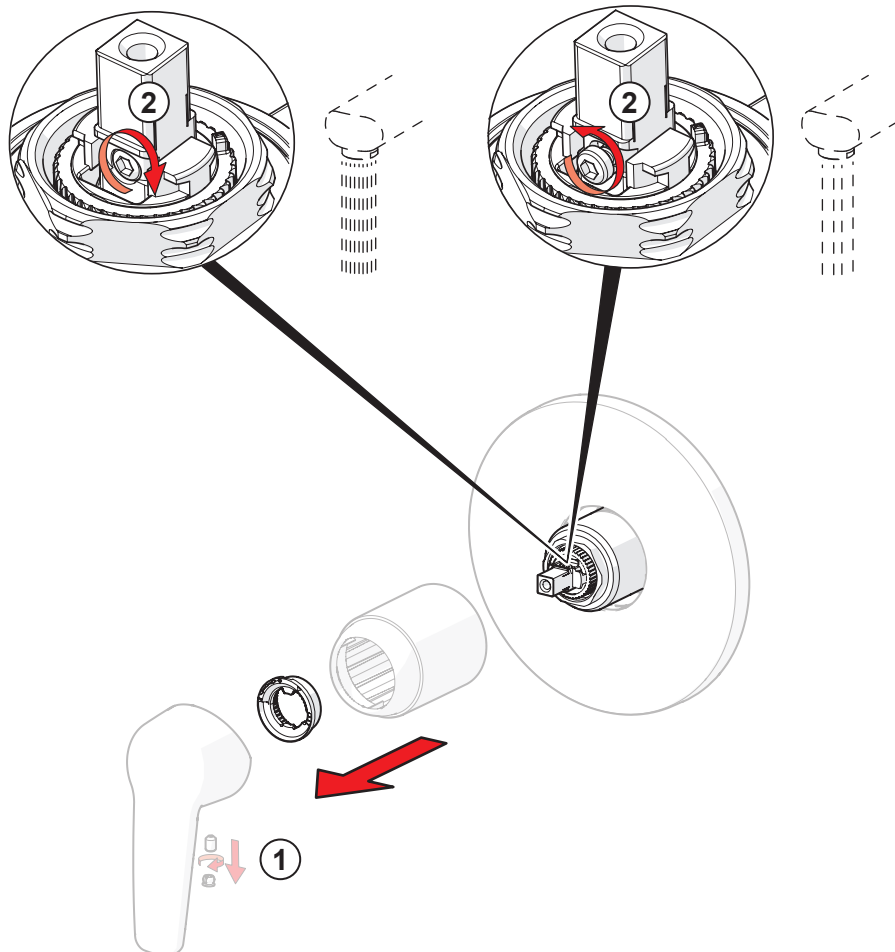

Cleaning the faucet

CZ Čištění baterie

DE Reinigung der Armatur

DK Rengøring af armaturet

ES Limpieza de la grifería

FI Puhdistus

FR Nettoyage du robinet

GR Καθαρισμός του βρύση

HU Takarítás a csapot

IT Pulizia della rubinetteria

NL Reinigen van de kraan

NO Rengjøring av kranen

PL Czystczenie baterii

PT Limpeza da torneira

RU Чистка смесителя

SE Rengöring av blandarna

SK Čistenie vodovodnej batérie

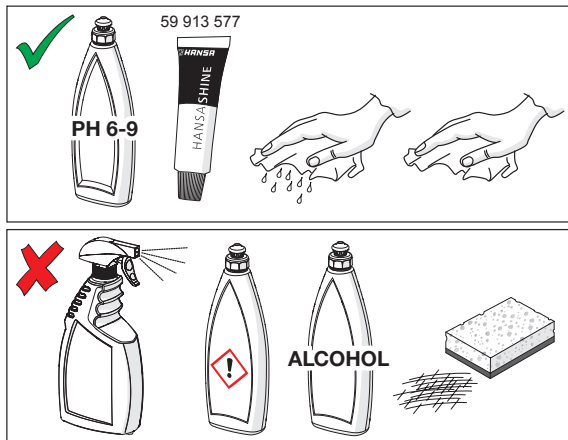

Spare parts

CZ Náhradní díly

FI Varaosat

NL Reserveonderdelen

RU Запасные части

DE Ersatzteile

FR Pièces détachées

NO Reservedeler

SE Reservdelar

DK Reservedele

HU Alkatrészek

PL Części zamienne

SK Náhradné diely

ES Piezas de recambio

IT Pezzi di ricambio

PT Peças de reposição

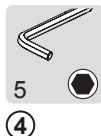
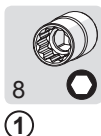

59 914 182

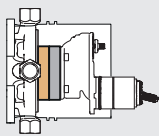

15 mm (max. 30 mm)

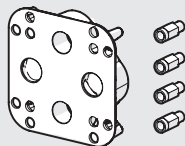

Extension set

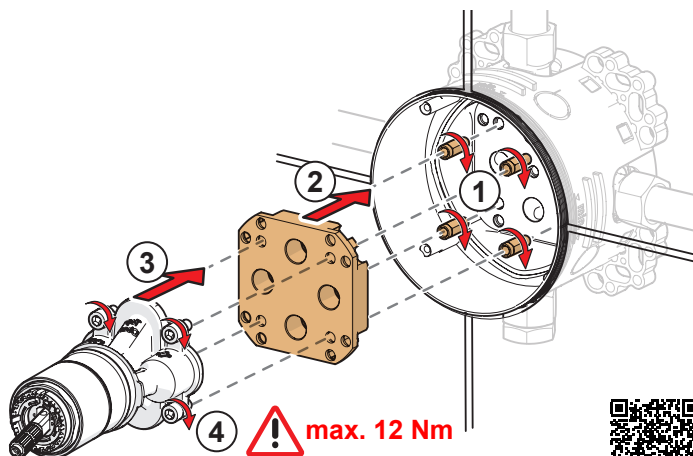

http://movie.hansa.com/blbx_trblshoot_extension

59 914 184

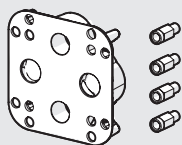

Reverse adapter

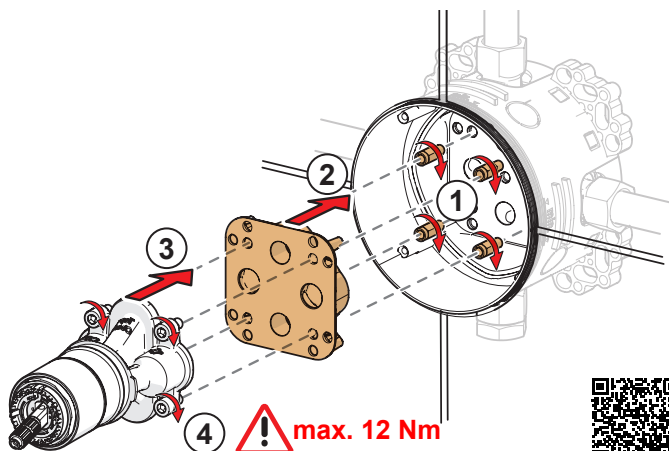

http://movie.hansa.com/blbx_trblshoot_warmcold

Spare parts

CZ Náhradní díly

DE Ersatzteile

DK Reservedele

ES Piezas de recambio

FI Varaosat

FR Pièces détachées

HU Alkatrészek

IT Pezzi di ricambio

NL Reserveonderdelen

NO Reservedeler

PL Części zamienne

PT Peças de reposição

RU Запасные части

SE Reservdelar

SK Náhradné diely

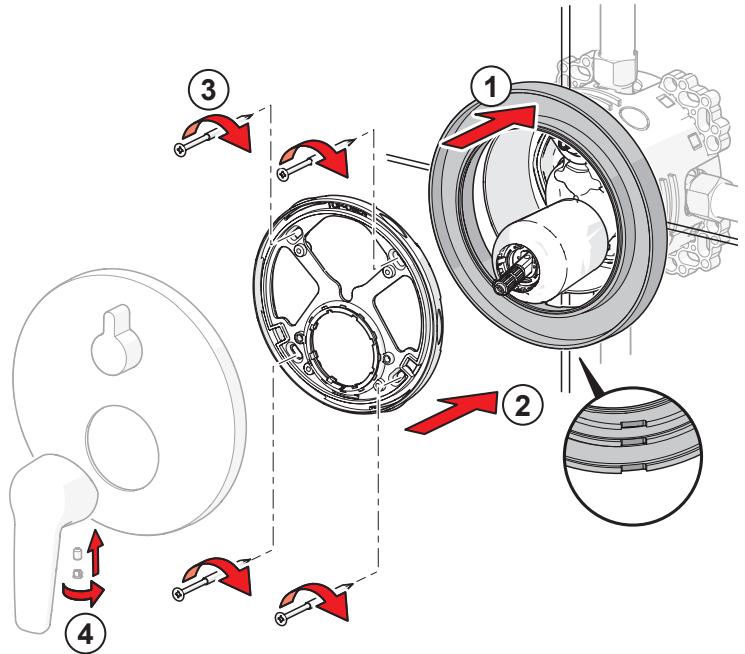
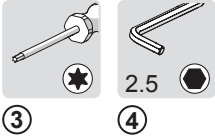

59 914 191

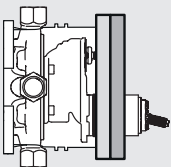

15 mm (max. 30 mm)

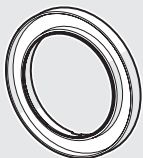

Distance adapter

59 914 192

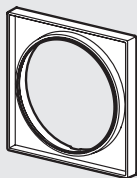

http://movie.hansa.com/blbx_trblshoot_extension

Spare parts

CZ Náhradní díly

DE Ersatzteile

DK Reservedele

ES Piezas de recambio

FI Varaosat

FR Pièces détachées

HU Alkatrészek

IT Pezzi di ricambio

NL Reserveonderdelen

NO Reservedeler

PL Części zamienne

PT Peças de reposição

RU Запасные части

SE Reservdelar

SK Náhradné diely

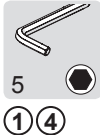
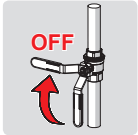

① ④

① M6 x 12

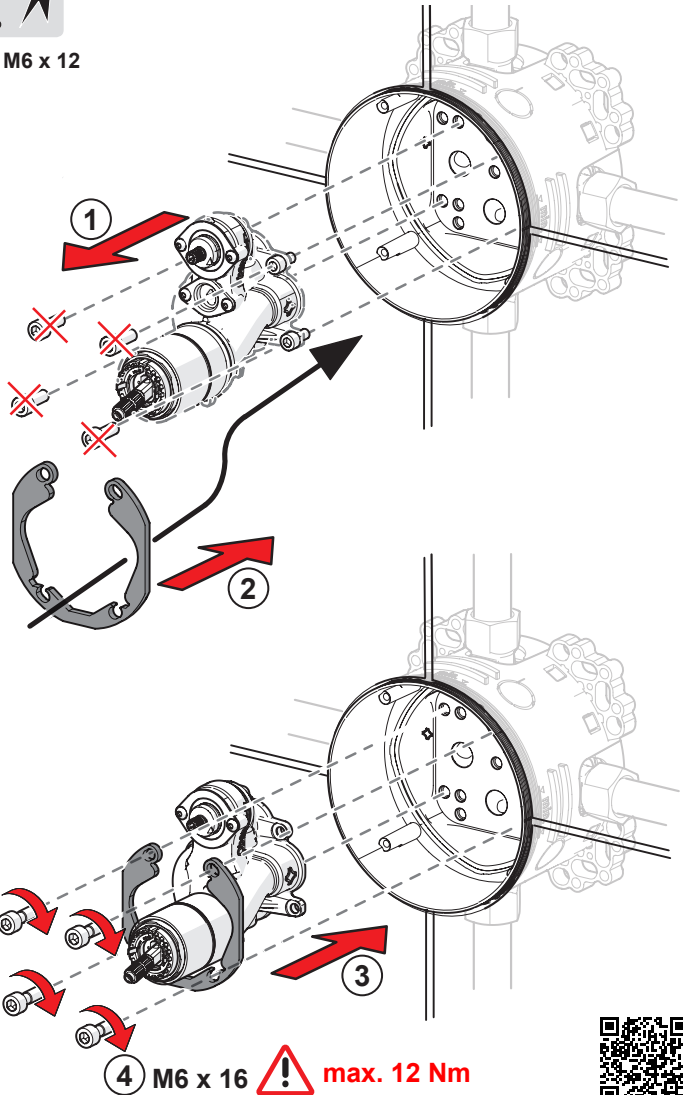

59 914 186



max $\pm 3.5^\circ$

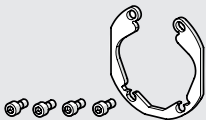

Bluetune kit

④ M6 x 16 max. 12 Nm



http://movie.hansa.com/blbx_trblshoot_angle

Oras Group is a powerful European provider of sanitary fittings: the market leader in the Nordics and a leading company in Continental Europe. The company's mission is to make the use of water easy and sustainable and its vision is to become the European leader of advanced sanitary fittings. Oras Group has two strong brands, Oras and Hansa.

The head office of the Group is located in Rauma, Finland, and the Group has four manufacturing sites: Burglengenfeld (Germany), Kralovice (Czech Republic), Olesno (Poland) and Rauma (Finland). Oras Group employs approximately 1400 people in twenty countries. Oras Group is owned by Oras Invest, a family company and an industrial owner.

HANSA Armaturen GmbH
P. O. BOX 81 02 40
D-70519 Stuttgart

Sigmaringer Strasse 107
D-70567 Stuttgart
Tel.: +49 711 16 14 0
Fax: +49 711 16 14 368
info@hansa.de

www.hansa.com



a member of  orasgroup