

- DE** Gebrauchsanleitung / Montageanleitung
FR Mode d'emploi / Instructions de montage
EN Instructions for use / assembly instructions
IT Istruzioni per l'uso / Istruzioni per Installazione
ES Modo de empleo / Instrucciones de montaje
NL Gebruiksaanwijzing / Handleiding
DK Brugsanvisning / Monteringsvejledning
PT Instruções para uso / Manual de Instalação
PL Instrukcja obsługi / Instrukcja montażu
CS Návod k použití / Montážní návod
SK Návod na použitie / Montážny návod
ZH 用户手册 / 组装说明
RU Руководство пользователя /
Инструкция по монтажу
FI Käyttöohje / Asennusohje
SV Bruksanvisning / Monteringsanvisning
LT Vartotojo instrukcija / Montavimo instrukcijos
HR Upute za uporabu / Uputstva za instalaciju
TR Kullanım kılavuzu / Montaj kılavuzu
RO Manual de utilizare / Instrucțiuni de montare
EL Οδηγίες χρήσης / Οδηγία συναρμολόγησης
SL Navodilo za uporabo / Navodila za montažo
ET Kasutusjuhend / Paigaldusjuhend
LV Lietošanas pamācība / Montāžas instrukcija
SR Uputstvo za upotrebu / Uputstvo za montažu
NO Bruksanvisning / Montasjeveiledning
BG Инструкция за употреба /
Ръководство за монтаж
SQ Udhëzuesi i përdorimit / Udhëzime rreth montimit
AR دليل الاستخدام / تعليمات التجميع
HU Használati útmutató / Szerelési útmutató

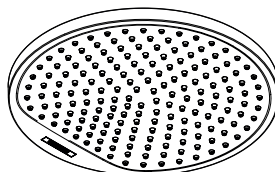

Crometta S 240 1jet
26723000

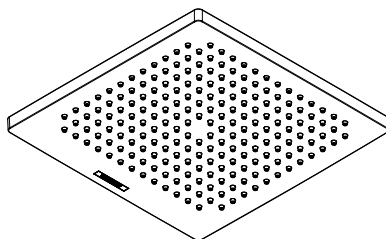

Crometta E 240 1jet
26726000



Crometta S 240 1jet 26723000

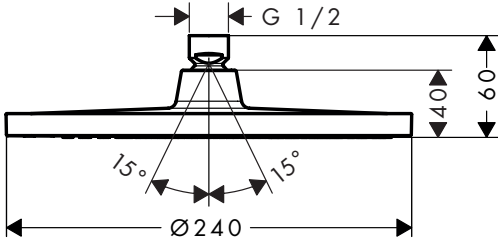

Crometta E 240 1jet 26726000

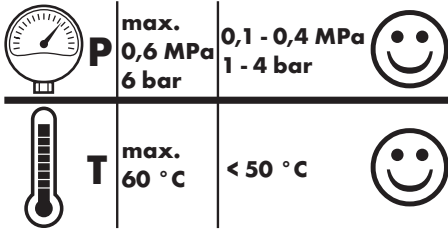
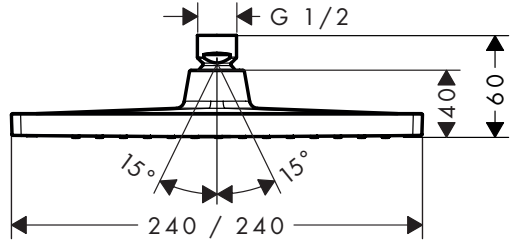

Crometta S 240 1jet 26723000

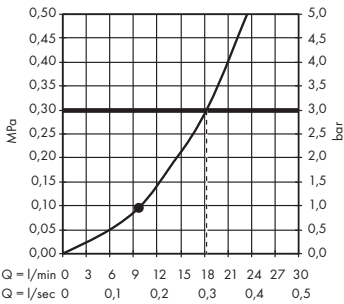

Crometta E 240 1jet 26726000

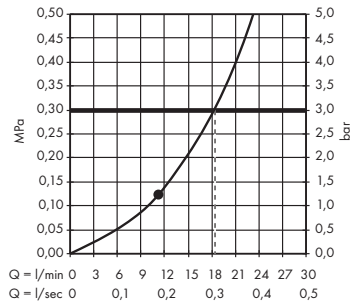

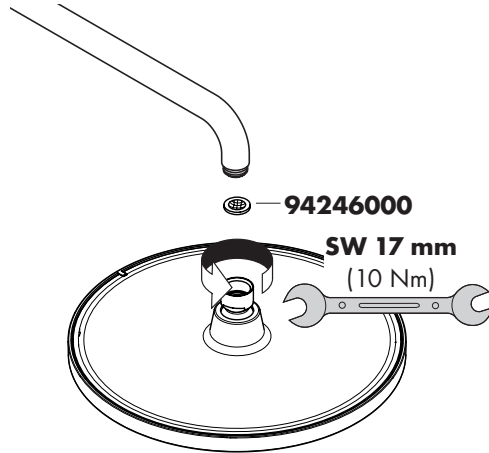

	P-IX	DVGW	SINTEF	NF	STF	CERTIFICATION BODY KIWA
26723000	P-IX 28843/IIB			X		
26726000	P-IX 28844/IIB			X		





- DE** Reinigungsempfehlung / Garantie / Kontakt
- FR** Recommandation pour le nettoyage / Garanties / Contact
- EN** Cleaning recommendation / Warranty / Contact
- IT** Raccomandazione di pulizia / Garanzia / Contatto
- ES** Recomendaciones para la limpieza / Garantía / Contacto
- NL** Aanbevelingen inzake reiniging / Garantie / Contact
- DK** Rensning, anbefaling / Garanti / Kontakt
- PT** Recomendações de limpeza / Garantia / Contacto
- PL** Zalecenie dotyczące pielęgnacji / Gwarancja / Kontakt
- CS** Doporučení k čištění / Záruka / Kontakt
- SK** Odporúčania pre čistenie / Záruka / Kontakt
- ZH** 清洁指南 / 担保 / 接触
- RU** Рекомендации по очистке / Гарантия / Контакты
- HU** Tisztítási tanácsok / Garancia / érintkezés
- FI** Puhdistussuositus / Takuu / Kosketus
- SV** Rengöringsrekommendationer / Garanti / Contacto
- LT** Valymo rekomendacijos / Garantija / Kontaktai
- HR** Preporuke za čišćenje / Garancija / Kontakt
- TR** Temizleme önerisi / Garanti / Temas
- RO** Recomandări pentru curățare / Garanție / Contact
- EL** Σύσταση καθαρισμού / Εγγύηση / επαφή
- SL** Priporočilo za čiščenje / Garancija / Kontakt
- ET** Puhastussuovitused / Garantii / Kontakt
- LV** Tīrīšanas ieteikumi / Garantija / Kontakti
- SR** Preporuke za čišćenje / Garancija / Kontakt
- NO** Anbefaling for rengjøring / Garanti / Kontakt
- BG** Препоръка за почистване / Гаранция / Контакт
- SQ** Këshilla rreth pastrimit / Garancia / Kontakt
- KO** 세정시 권장사항 / 품질보증 / 접촉
- AR** توصيات التنظيف / الضمان (الولايات المتحدة الأمريكية) / اتصال



[www.hansgrohe.com/
cleaning-recommendation](http://www.hansgrohe.com/cleaning-recommendation)



[www.hansgrohe.com/
cleaning-recommendation](http://www.hansgrohe.com/cleaning-recommendation)



[www.hansgrohe.com/
cleaning-recommendation](http://www.hansgrohe.com/cleaning-recommendation)



[www.hansgrohe.com/
cleaning-recommendation](http://www.hansgrohe.com/cleaning-recommendation)

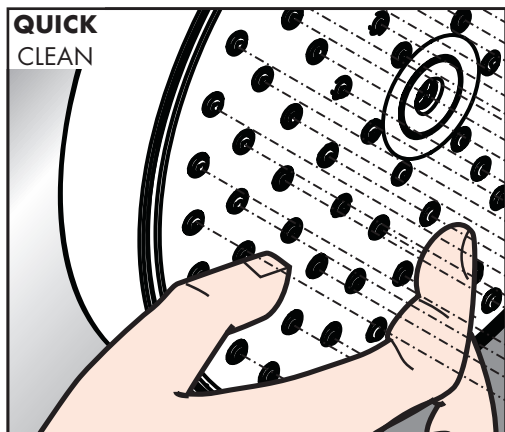

DE Einfach sauber: Kalk lässt sich von den Noppen ganz leicht abrubbeln.

FR La propreté en toute simplicité: les dépôts formés sur les buses élastiques en silicone s'éliminent par un simple passage de la main.

EN Just clean: simply rub over the spray nozzles to remove lime scale.

IT Facile da pulire: Il calcare viene eliminato semplicemente dagli ugelli elastici in silicone.

ES Fácil asear: La cal se puede retirar sencillamente frotando con los dedos de las toberas elásticas de silicona.

NL Eenvoudig schoon: Kalk kan eenvoudig van de noppen worden gewreven.

DK Enkel rengøring: Det er let at fjerne kalkaflejringer fra stråledyserne.

PT Simplesmente limpo: o calcário pode ser simplesmente retirado das saliências através de fricção.

PL Po prostu czysto: Pęczki można całkiem łatwo oczyścić z kamienia.

CS Jednoduše čistě: Vapenné usazeniny můžete z popků snadno odstranit oříením.

SK Jednoducho čistý: Vodný kameň sa dá zo štetín celkom ľahko odstrániť.

ZH 清洁: 只需要揉搓花洒表面的出水孔即可去除水垢。

RU Простота чистки: известь очень легко стирается с утолщений.

HU Egyszerűen tisztá: a vízkő egészen könnyen ledörzsölhető a csomókról.

FI Yksinkertaisesti puhdas: kalkin voi helposti hieroa irti nyyivistä.

SV Enkelt att göra rent: det är lätt att ta bort kalk från popporna.

LT Paprasta švara: kalkės lengvai nugrandomos nuo kilpos.

HR Jednostavno čisto: Kamenac se sasvim lako uklanja s izbočina.

TR Sadece temiz: Kireç, düğümlerle kolayca ovalanabilir.

RO Pur și simplu curat: Calcarul se îndepărtează ușor de pe noduri prin frecare.

EL Απλά τέλεια καθαριότητα: Τα άλματα μπορούν να αφαιρεθούν με μεγάλη ευκολία από τα στόμια.

SL Preprosto čisto: arpenec se z lahkoto podrgne z vozličkov.

ET Lihtsalt puhas: luoja saab nuppudel lihtsalt maha hõõruda.

LV Vienkārša tīrīšana: kaļķis no izvirzījumiem ir viegli norubināms.

SR Jednostavno čisto: Kamenac se sasvim lako skida sa izbočina.

NO Simpelten ren: Ved å gnikke er det lett å fjerne kalk fra nuppene.

BG Просто чисто: Варовикът лесно може да се изърси от удебеленията.

SQ Thjesht dhe pastër. Mbetjet gëlqerore mund të hiqen me fërkim të lehtë.

AR إنه سهل التنظيف، حيث يسقط الجير بسهولة شديدة من الأجزاء الناتئة

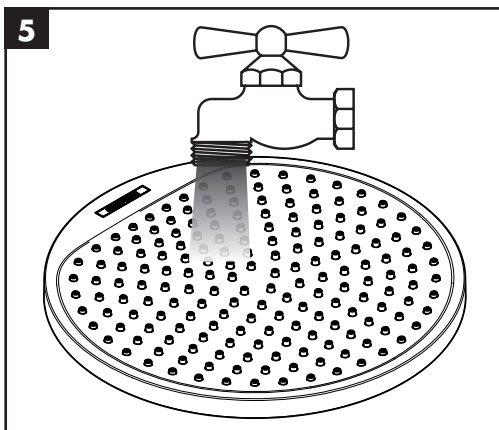
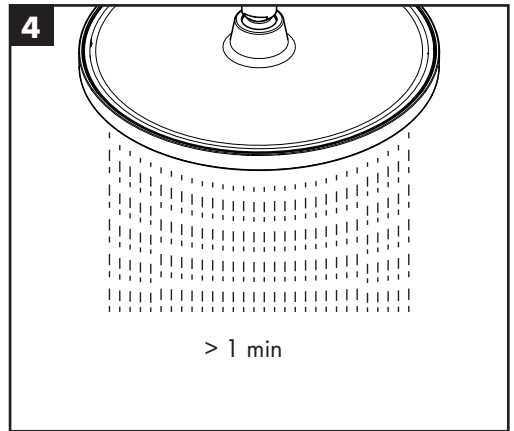
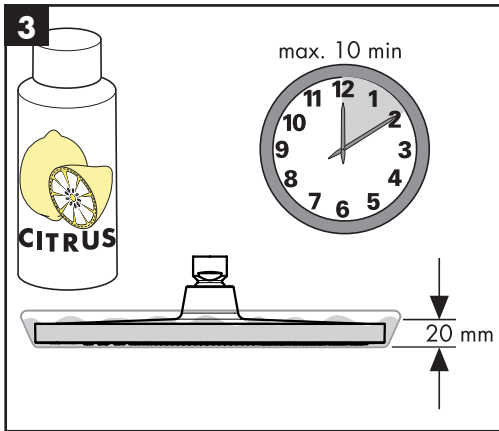
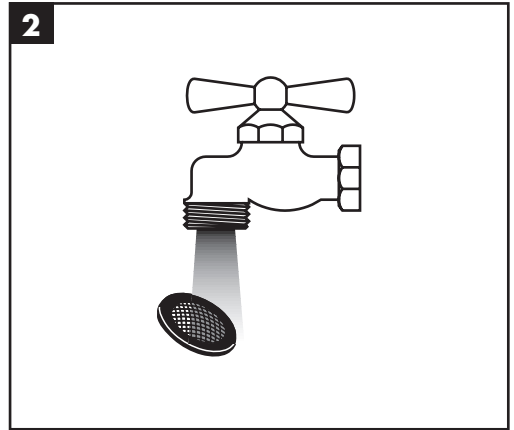
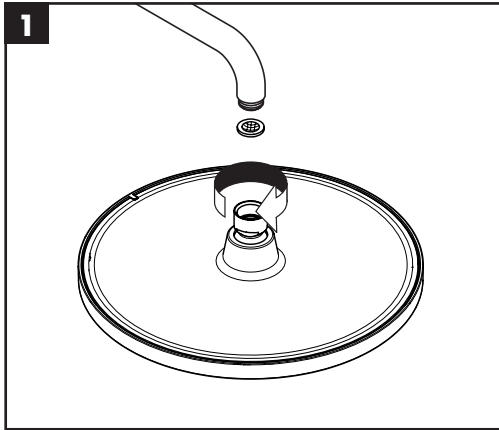



hansgrohe

Hansgrohe · AuestraÙe 5 · 9 · D-77761 Schiltach · Telefon +49 (0) 78 36/51-1282 · Telefax +49 (0) 7836/511440
E-Mail: info@hansgrohe.com · Internet: www.hansgrohe.com

10/2019
9.0130001