

WPC QI - EN 62479 - ICNIRP

⚠ Safety instructions

The instructions for installation and use must be strictly observed in order to avoid the risk of electric shock or fire.

(GB)

⚠ Consignes de sécurité

Ne pas respecter strictement les conditions d'installation et d'utilisation peut entraîner des risques de choc électrique ou d'incendie.

(FR)

⚠ Consignas de seguridad

El no cumplimiento estricto de las instrucciones de instalación y uso puede implicar riesgos de choque eléctrico o incendio.

(ES)

⚠ Instruções de segurança

Não respeitar estritamente as condições de instalação e de utilização poderá proocar riscos de choque eléctrico ou de incêndio.

(PT)

⚠ Przepisy bezpieczeństwa

Niezastosowanie się ściśle do warunków instalacji i użytkowania może grozić porażeniem prądem lub pożarem.

(PL)

⚠ Συστάσεις ασφαλείας

Η μη αυστηρή τήρηση των συνθηκών εγκατάστασης και χρήσης μπορεί να επιφέρει κινδύνους ηλεκτροπληξίας ή πυρκαγιάς.

(GR)

⚠ Biztonsági előírások

A beszerelési és használati feltételek szigorú betartásának elmulasztása áramütés vagy tűz kockázatával jár.

(HU)

⚠ Instrucțiuni de siguranță

Nerespectarea strictă a condițiilor de instalare și utilizare poate genera riscuri de șocuri electrice sau incendiu.

(RO)

⚠ Указания за безопасност

Неспазването стриктно на указанията за сплбвяване и използване може да доведе до риск от токов удар или пожар.

(BG)

⚠ Varnostna navodila

Neupoštevanje vseh pogojev instalacije in uporabe lahko povzroči nevarnost električnega udara ali požara.

(SI)

⚠ Sigurnosne napomene

Ako se ne pridržavate strogo uvjeta za instalaciju i uporabu, može doći do strujnog udara ili požara.

(HR)

⚠ Bezpečnostní pokyny

Nedodržení stanovených podmínek instalace a používání může vést k rizikům zasažení elektrickým proudem nebo požáru.

(CZ)

⚠ Bezpečnostné nariadenia

V prípade nedodržania presných podmienok týkajúcich sa inštalácie a používania hrozí riziko úrazu elektrickým prúdom alebo vzniku požiaru.

(SK)

⚠ Sigurnosne preporuke

Ukoliko se ne pridržavate striktno uslova instaliranja i korišćenja, može doći dostrujnog udara ili požara.

(RS)

— N

— L





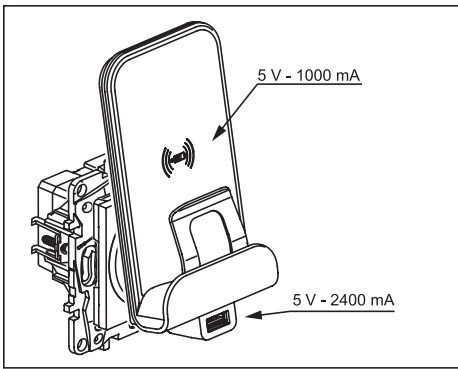

--- ⊥

- Neutral = blue
- Neutro = azul
- Neutro = azul
- Neutralny = niebieski
- Ουδέτερος = Μπλε
- Nulla vezeték = kék
- Neutru = albastru
- Нейтрала = синьо
- Ničelni vodnik = modra
- Multi przewodnik = plava
- Střední vodič = modra
- Nulový vodič = modra
- Nula = plava

- Phase = all but blue and green/yellow
- Fase = todos excepto azul e verde/amarelo
- Fase = todos excepto azul y verde/amarillo
- Fazowy = inny niż niebieski i zielono-żółty
- Φάση = όλα εκτός από μπλε και πράσινο/κίτρινο
- Fázis = mind, kivéve a kék és a zöld/sárga
- Faza = oricare, cu exceptia albastru si galben/verde
- Фаза = всичко освен синьо, зелено/жълто
- Fazni vodnik = katerakoli, razen modre in zeleno/rumena
- Fazni przewodnik = sve osim plave i zelene/žute boje
- Fázový vodič = všechny mimo modré a žlutozelené
- Fáza = ktorékoľvek okrem modrá a zelená/žltá
- Faza = sve osim plave i zelene/žute

- Earth = green/yellow
- Terra = verde/amarelo
- Tierra = verde/amarillo
- Uzemnienie = zielony-żółty
- Γειωση = Πράσινο/Κίτρινο
- Föld = zöld/sárga
- Impamantare = verde/galben
- Земля = зелено/жълто
- Ozemljitveni vodnik = zelena/rumena
- Uzemljenje = zelena/žuta
- Zemnicí vodič = zelená/žlutá
- Uzemnienie = zelená/žltá
- Zemlja = zelena/ žuta



 		P	
-10°C ... +70°C	-5°C ... +40°C	250 V~ 5 V~ 1000 mA / 2400 mA	 6 mm  2,5 mm²

